

4523, 4524, 4525

Photomultiplier Tubes

2-INCH DIAMETER—4523

3-INCH DIAMETER—4524

5-INCH DIAMETER—4525

10-STAGE, HEAD-ON TYPE
VENETIAN-BLIND DYNODE STRUCTURE

BIALKALI PHOTOCATHODE OF
HIGH QUANTUM EFFICIENCY

*For Use in Scintillation Counters for the Detection and
Measurement of Nuclear Radiation*

GENERAL

Spectral Response	See <i>Typical Spectral Response Characteristics</i>
Wavelength of Maximum Response.	4000 ± 500 angstroms
Cathode, Semitransparent.	Cs-K-Sb (Bialkali)
Shape	Flat, Circular
Minimum area:	
4523.	2.20 sq in
4524.	5.27 sq in
4525.	15.1 sq in
Minimum diameter:	
4523.	1.68 in
4524.	2.59 in
4525.	4.38 in
Window.	Corning ^a No.0080, or equivalent
Shape	Plano-Plano
Index of refraction at 4360 angstroms	1.523
Dynodes	
Substrate	Cu-Be
Secondary-emitting surface.	Be-O
Structure	Venetian-Blind
Direct Interelectrode Capacitances (Approx.)	
Anode to dynode No.10	7 pF
Anode to all other electrodes	8.5 pF
Maximum Overall Length	
4523.	5.81 in
4524.	6.31 in
4525.	7.69 in
Seated Length	
4523.	4.87 ± 0.19 in
4524.	5.38 ± 0.18 in
4525.	6.75 ± 0.19 in
Maximum Diameter	
4523.	2.31 in
4524.	3.06 in
4525.	5.31 in
Envelope	
4523.	T16
4524.	J24
4525.	J42
Socket.	Cinch ^b No.3M14, or equivalent



4523, 4524, 4525

Magnetic Shield

- 4523. JAN^c Part No.S-2004, or equivalent
- 4524. Millen^d Part No.80803J, or equivalent
- 4525. Millen^d Part No.80805M, or equivalent

Operating Position. Any

Weight (Approx.)

- 4523. 7 oz
- 4524. 9 oz
- 4525. 1 lb 7 oz

Base. Medium-Shell Diheptal 14-Pin
(JEDEC Group 5, No.B14-38)

TERMINAL DIAGRAM (Bottom View)

- Pin 1 - Dynode No.1
- Pin 2 - Dynode No.2
- Pin 3 - Dynode No.3
- Pin 4 - Dynode No.4
- Pin 5 - Dynode No.5
- Pin 6 - Dynode No.6
- Pin 7 - Dynode No.7
- Pin 8 - Dynode No.8
- Pin 9 - Dynode No.9
- Pin 10 - Dynode No.10
- Pin 11 - Anode
- Pin 12 - Internal Connection—
Do Not Use
- Pin 13 - Focusing Electrode
- Pin 14 - Photocathode

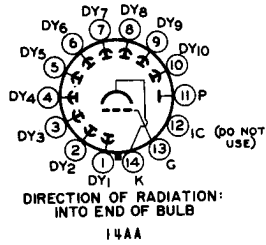

DIRECTION OF RADIATION:
INTO END OF BULB
14AA

Unless indicated otherwise, the following ratings and characteristic range values apply to all types

ABSOLUTE-MAXIMUM RATINGS

DC Supply Voltage

Between anode and cathode	2500	V
Between anode and dynode No.10.	300	V
Between consecutive dynodes	300	V
Between dynode No.1 and cathode	600	V
Between focusing electrode and cathode. . .	600	V

Average Anode Current ^e	0.5	mA
Ambient-Temperature Range ^f	-100 to +85	°C



CHARACTERISTIC RANGE VALUES

Under conditions with dc supply voltage (E) across a voltage divider providing 1/6 of E between cathode and dynode No.1, 1/12 of E for each succeeding dynode stage, and 1/12 of E between dynode No.10 and anode, except as noted. Focusing-electrode voltage is adjusted to that value between 50 and 100 per cent of dynode-No.1 potential (Referred to cathode) which provides maximum anode current.

With E = 1500 volts except as noted

	Min	Typ	Max	
Sensitivity				
Radiant ^g at 4000 angstroms.	-	3.2×10^4	-	A/W
Cathode radiant ^h at 4000 angstroms:				
4523, 4524.	-	0.071	-	A/W
4525.	-	0.08	-	A/W
Luminous:				
With tungsten light source ^j	10	27	100	A/lm
With blue light source ^k	1.5×10^{-5}	4×10^{-5}	1.5×10^{-4}	A
Cathode luminous:				
With tungsten light source ^m				
4523, 4524.	-	6×10^{-5}	-	A/lm
4525.	-	6.7×10^{-5}	-	A/lm
With blue light source ⁿ				
4523, 4524.	7×10^{-10}	9×10^{-9}	-	A
4525.	7×10^{-10}	1×10^{-10}	-	A
Quantum efficiency at 4000 angstroms:				
4523, 4524.	-	22	-	%
4525.	-	25	-	%
Current Amplification				
4523, 4524.	-	4.5×10^5	-	
4525.	-	4×10^5	-	
Anode Dark Current^p				
4523.	-	5×10^{-10}	3×10^{-9}	A
4524.	-	1×10^{-9}	3×10^{-9}	A
4525.	-	1.5×10^{-9}	4×10^{-9}	A
Equivalent Anode-Dark-Current Input				
4523.	-	$3.8 \times 10^{-11} \text{q}$	-	1m
	-	$3.2 \times 10^{-14} \text{r}$	-	W
4524.	-	$7.7 \times 10^{-11} \text{q}$	-	1m
	-	$6.5 \times 10^{-14} \text{r}$	-	W
4525.	-	$1.1 \times 10^{-10} \text{q}$	-	1m
	-	$9.3 \times 10^{-14} \text{r}$	-	W
Dark-Pulse Spectrum ^q	See Typical Dark-Pulse Spectrum			
Pulse Height Resolution ^{s, t}	-	7.5	-	%



4523, 4524, 4525

	Min	Typ	Max	
Mean Gain Deviation^{a, u}				
With count rate change of 10,000 to 1,000 Hz ^v	-	1	-	%
For period of 16 hours at a count rate of 10,000 Hz ^w	-	1	-	%
Anode Pulse Rise Time^x				
4523.	-	1.2x10 ⁻⁸	-	s
4524.	-	1.4x10 ⁻⁸	-	s
4525.	-	1.8x10 ⁻⁸	-	s
Electron Transit Time^y				
4523.	-	5.9x10 ⁻⁸	-	s
4524.	-	6.5x10 ⁻⁸	-	s
4525.	-	1.1x10 ⁻⁷	-	s

- a Made by Corning Glass Works, Corning, New York.
- b Made by Cinch Manufacturing Company, 1026 South Homan Avenue, Chicago 24, Illinois.
- c Made by JAN Hardware Manufacturing Corp., 38-01, Queens Blvd., Long Island City 1, N.Y.
- d Made by James Millen Manufacturing Company, 150 Exchange Street, Malden 48, Mass.
- e Averaged over any interval of 30 seconds maximum.
- f Tube operation at or below room temperature is recommended.
- g This value is calculated from the typical luminous sensitivity rating using a conversion factor of 1190 lumens per watt.
- h This value is calculated from the typical cathode luminous sensitivity rating using a conversion factor of 1190 lumens per watt.
- j These values are calculated as shown below:

$$\text{Luminous Sensitivity (A/lm)} = \frac{\text{Anode Current (with blue light source)(A)}}{0.15 \times \text{Light Flux of } 1 \times 10^{-5} \text{ (lm)}}$$

The value of 0.15 is the average value of the ratio of the anode current measured under the conditions specified in footnote (k) to the anode current measured under the same conditions but with the blue filter removed.

- k Under the following conditions: Light incident on the cathode is transmitted through a blue filter (Corning C.S. No. 5-58, polished to 1/2 stock thickness — Manufactured by the Corning Glass Works, Corning, New York) from a tungsten-filament lamp operated at a color temperature of 2870°K. The value of light flux incident on the filter is 10 microlumens.

- m This value is calculated as shown below:

$$\text{Cathode Luminous Sensitivity (A/lm)} = \frac{\text{Cathode Current (with blue light source)(A)}}{0.15 \times \text{Light Flux of } 1 \times 10^{-4} \text{ (lm)}}$$

The value of 0.15 is the average value of the ratio of the cathode current measured under the conditions specified in footnote (n) to the cathode current measured under the same conditions but with the blue filter removed.

- n Under the following conditions: Light incident on the cathode is transmitted through a blue filter (Corning C.S. No. 5-58, polished to 1/2 stock thickness — Manufactured by the Corning Glass Works, Corning, New York) from a tungsten-filament lamp operated at a color temperature of 2870°K. The value of light flux incident on the filter is 1 x 10⁻⁴ lumen and 300 volts are applied between cathode and all other electrodes connected as anode.

- p At a tube temperature of 22°C. Light incident on the cathode is transmitted through a blue filter (Corning C.S. No. 5-58, polished to 1/2 stock thickness). The light flux incident on the filter is 10 microlumens. The supply voltage E is adjusted to obtain an anode current of 20 microamperes. Sensitivity of these types under these conditions is approximately equivalent to 13 amperes per lumen. Dark current is measured with no light incident on the tube.



- q With supply voltage E adjusted to give an equivalent luminous sensitivity of 13 amperes per lumen.
- r At 4000 angstroms. This value is calculated from the EADCI value in lumens using a conversion factor of 1190 lumens per watt.
- s With the following voltage distribution: 3/13 of E between cathode and dynode No. 1, 1/13 of E for each succeeding dynode stage, and 1/13 of E between dynode No. 10 and anode. Focusing-electrode voltage is adjusted to that value between 50 and 100 per cent of dynode-No. 1 potential (referred to cathode) which provides maximum anode current.
- t Pulse height resolution is defined as the quotient of the full width of the photopeak at half height by the pulse height at maximum count rate under the following conditions: The 662 keV photon from an isotope of cesium having an atomic mass of 137 (Cs^{137}) and a cylindrical 2 inch x 2 inch (for 4523), 3 inch x 3 inch (for 4524 or 4525) thallium-activated sodium-iodide scintillator [NaI(Tl)-type 8D8 (for 4523), 12D12 (for 4524 or 4525)] are used. This scintillator is manufactured by the Harshaw Chemical Corporation, 1945 East 97 Street, Cleveland 6, Ohio, and is rated by the manufacturer as having a resolution capability of 7.5%. The Cs^{137} source is in direct contact with the metal end of the scintillator. The faceplate end of the crystal is coupled to the tube by a coupling fluid such as Dow Corning Corp., Type DC200 (viscosity of 100 centipoise) — manufactured by the Dow Corning Corp., Midland, Michigan, or equivalent.
- u Mean Gain Deviation is defined as follows:
- $$MGD = \frac{\sum_{i=1}^n n \left| \bar{p} - p_i \right|}{n \bar{p}} \cdot 100$$
- where \bar{p} = mean pulse height
 p_i = pulse height at the "i"th reading
 n = total number of readings
- v Under the following conditions: The scintillator and Cs^{137} radiation source of (t) are employed. The radiation source is initially centered on the major axis of the tube and the scintillator, at a point providing a pulse count rate of 10,000 Hz. The pulse height of the photopeak is measured under this condition. Next, the radiation source is moved rapidly, in approximately 30 seconds, to a new position that is equivalent to a count rate of 1,000 Hz. The new position is also centered in the major axis of the tube. The pulse height under this condition is measured. Mean gain deviation is defined as shown in (u).
- w Under the same conditions as shown in (v) except the tube is operated for a period of 1/2 hour with the radiation source located at the point providing a pulse count rate of 10,000 Hz. Following this time interval, the pulse height is sampled at this count rate at 1-hour intervals for a period of 16 hours. Mean gain deviation is defined as shown in (u).
- x Measured between 10 per cent and 90 per cent of maximum anode-pulse height. This anode-pulse rise time is primarily a function of transit time variation and is measured under conditions with the incident light fully illuminating the photocathode.
- y The electron transit time is the time interval between the arrival of a delta function light pulse at the entrance window of the tube and the time at which the output pulse at the anode terminal reaches peak amplitude. The transit time is measured under conditions with the incident light fully illuminating the photocathode.

OPERATING CONSIDERATIONS

The *base pins* of these types fit a diheptal 14-contact socket, such as Cinch No. 3M14, or equivalent. The socket should be made of high-grade, low-leakage material, and should be installed so that incident light falls on the face end of the tube.

The *operating stability* of these types are dependent on the magnitude of the anode current. The use of an average anode current well below the maximum rated value of 0.5 milliampere is recommended when stability of operation is important. When stability is of prime importance, the use of an average anode current of 1 microampere or less, commensurate with



satisfactory output signal, is recommended.

Electrostatic and magnetic shielding of these types may be required in some applications. When a shield is used, it must be at cathode potential.

The *high voltages* at which these types are operated are very dangerous. Care should be taken in the design of apparatus to prevent the operator from coming in contact with these high voltages. Precautions should include the enclosure of high-potential terminals and the use of interlock switches to break the primary circuit of the high-voltage power supply when access to the apparatus is required.

Accompanying Typical Voltage-Divider Arrangements are recommended for use with these types. Recommended resistance values for the voltage dividers range from 10,000 ohms per stage to 1,000,000 ohms per stage. The choice of resistance values for any voltage-divider network is usually a compromise. If low values of resistance per stage are utilized, the power drawn from the regulated power supply and the required wattage rating of the resistors increase. Phototube noise may also increase due to heating if the divider network is mounted near the photocathode. The use of resistance values near 1 megohm per stage may cause deviation from linearity if the voltage-divider current is not maintained at a value of at least 10 times that of the maximum value of anode current, and may limit anode-current response to pulsed light. The latter effect may be reduced by connecting capacitors between the tube socket terminals for dynodes No.7 and No.8, dynodes No.8 and No.9, dynodes No.9 and No.10, and between dynode No.10 and anode return. In addition to nonlinearity and pulse-limiting effects, the use of resistance values exceeding 1 megohm per stage make these types more susceptible to leakage effects between terminals with possible resulting deviation in interstage voltage leading to a loss of current amplification.



TYPICAL VOLTAGE-DIVIDER ARRANGEMENT FOR GENERAL PHOTOMETRIC APPLICATIONS

4523 4524 4525

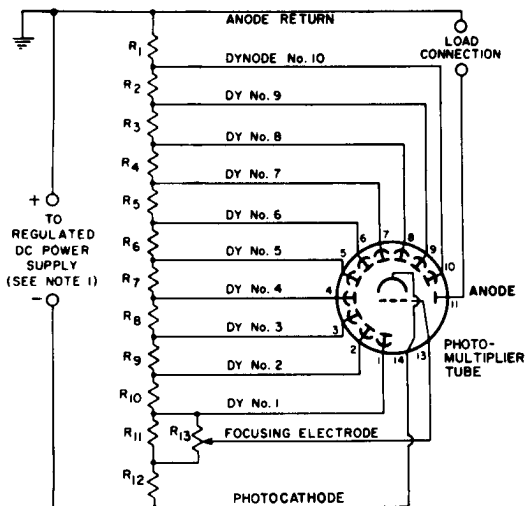

92LM-1611

R₁ through R₁₂: 470,000 ohms, 1/2 watt

R₁₃: 5 megohms, 1/2 watt, adjustable

Note 1: Adjustable between approximately 800 and 2500 volts dc.

Note 2: Component values are dependent upon nature of application and output signal desired.



4523, 4524, 4525

TYPICAL VOLTAGE-DIVIDER ARRANGEMENT FOR SCINTILLATION COUNTER APPLICATIONS

4523 4524 4525

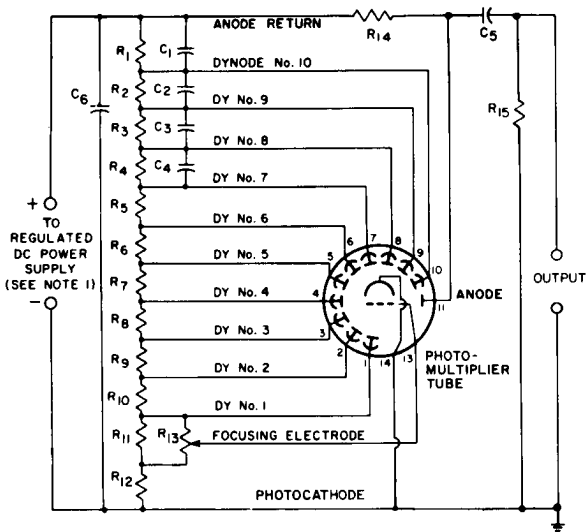

92LM-1612

- C_1 : 0.05 μF , 500 volts (dc working)
- C_2 : 0.02 μF , 500 volts (dc working)
- C_3 : 0.01 μF , 500 volts (dc working)
- C_4 : 0.005 μF , 500 volts (dc working)
- C_5 and C_6 : 0.005 μF , 3000 volts (dc working)
- R_1 through R_{10} : 470,000 ohms, 1/2 watt
- R_{11} and R_{12} : 750,000 ohms, 1/2 watt
- R_{13} : 5 megohms, 1/2 watt, adjustable
- R_{14} : 1 megohm, 1/2 watt
- R_{15} : 100,000 ohms, 1/2 watt

Note 1: Adjustable between approximately 800 and 2500 volts dc.

Note 2: Capacitors C_1 through C_5 should be connected at tube socket for optimum high-frequency performance.

Note 3: Component values are dependent upon nature of application and output signal desired.



DIMENSIONAL OUTLINE

4523

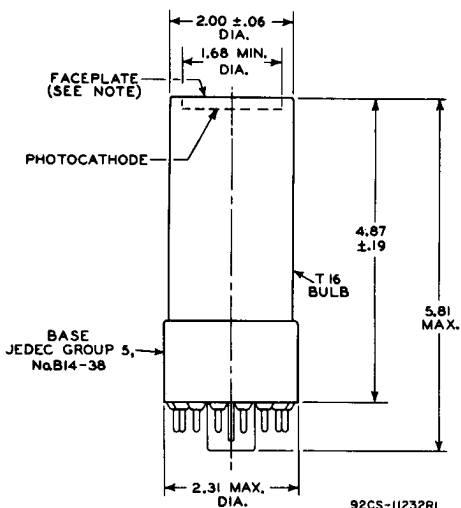

DIMENSIONS IN INCHES

Center line of bulb will not deviate more than 2° in any direction from the perpendicular erected at the center of bottom of the base.

Note: Within 1.68-inch diameter, deviation from flatness of external surface of faceplate will not exceed 0.100 inch from peak to valley.



4523, 4524, 4525

DIMENSIONAL OUTLINE

4524

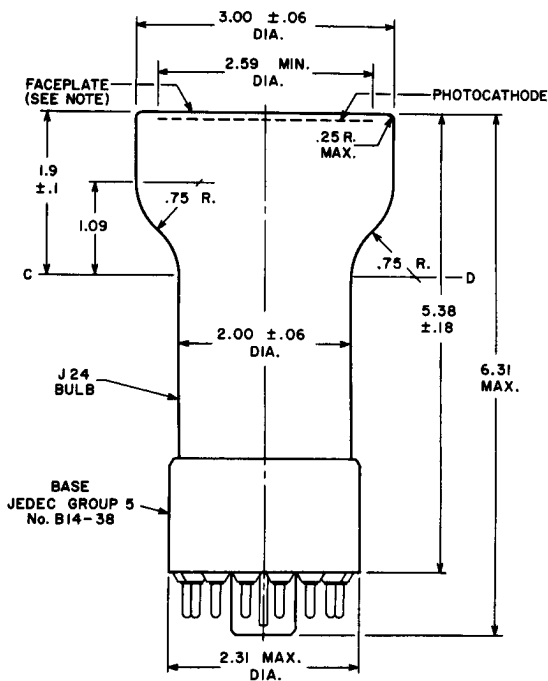

92CM-11080R2

DIMENSIONS IN INCHES

Center line of bulb will not deviate more than 2° in any direction from the perpendicular erected at the center of bottom of the base.

Note: Within 2.59-inch diameter, deviation from flatness of external surface of faceplate will not exceed 0.010 inch from peak to valley.

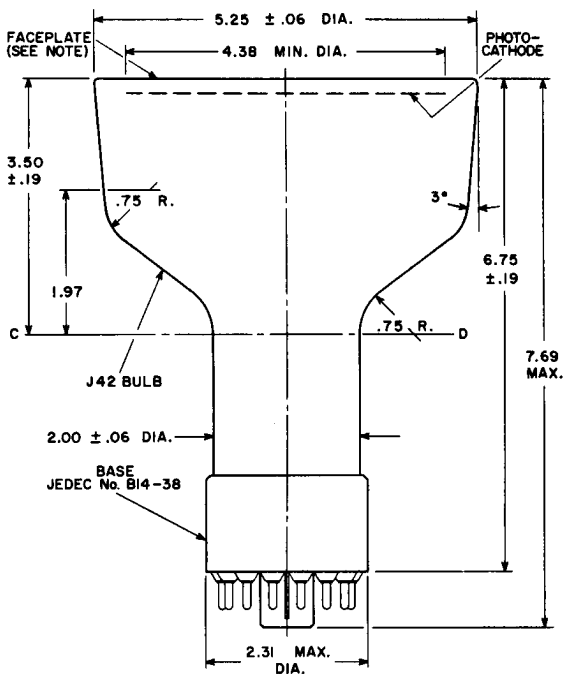

DIMENSIONAL OUTLINE
 4525

92CM-11148R2

DIMENSIONS IN INCHES

Center line of bulb will not deviate more than 2° in any direction from the perpendicular erected at the center of bottom of the base.

Note: Within 4.38-inch diameter, deviation from flatness of external surface of faceplate will not exceed 0.010 inch from peak to valley.



Typical Time Resolution Characteristics

4523

DYNODE NO. 1-TO-CATHODE VOLTS = $1/6 E$
 EACH SUCCEEDING DYNODE-STAGE VOLTS = $1/12 E$
 ANODE-TO-DYNODE NO. 10 VOLTS = $1/12 E$
 FOCUSING-ELECTRODE VOLTAGE IS ADJUSTED TO THAT VALUE
 BETWEEN 50 AND 100 PER CENT OF DYNODE NO. 1 POTENTIAL
 (REFERRED TO CATHODE) WHICH PROVIDES MAXIMUM ANODE
 CURRENT.
 PHOTOCATHODE IS FULLY ILLUMINATED.

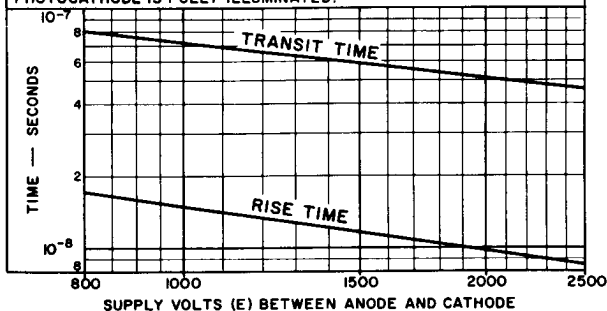

92CS-12309

Typical Time Resolution Characteristics

4524

DYNODE NO. 1-TO-CATHODE VOLTS = $1/6 E$
 EACH SUCCEEDING DYNODE-STAGE VOLTS = $1/12 E$
 ANODE-TO-DYNODE NO. 10 VOLTS = $1/12 E$
 FOCUSING-ELECTRODE VOLTAGE IS ADJUSTED TO THAT VALUE
 BETWEEN 50 AND 100 PER CENT OF DYNODE NO. 1 POTENTIAL
 (REFERRED TO CATHODE) WHICH PROVIDES MAXIMUM ANODE
 CURRENT.
 PHOTOCATHODE IS FULLY ILLUMINATED.

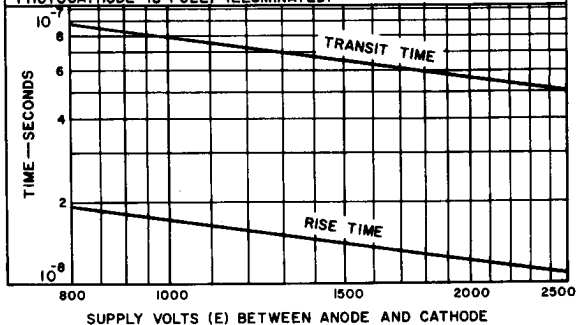

92LS-1854



Typical Time Resolution Characteristics

4525

DYNODE No.1-TO-CATHODE VOLTS = $1/6 E$
 EACH SUCCEEDING DYNODE-STAGE VOLTS = $1/12 E$
 ANODE-TO-DYNODE No.10 VOLTS = $1/12 E$
 FOCUSING-ELECTRODE VOLTAGE IS ADJUSTED TO THAT VALUE BETWEEN 50 AND 100 PER CENT OF DYNODE No.1 POTENTIAL (REFERRED TO CATHODE) WHICH PROVIDES MAXIMUM ANODE CURRENT.
 PHOTOCATHODE IS FULLY ILLUMINATED.

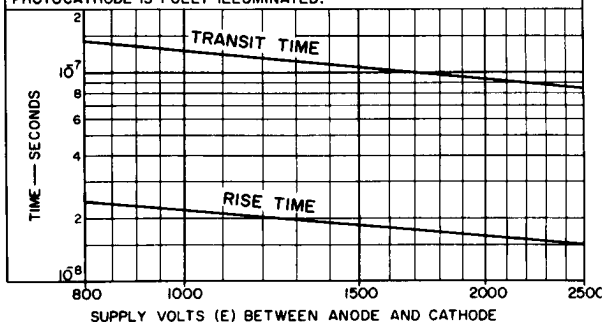

92CS-12313

Typical Characteristic of Output Current as a Function of Dynode-No.5 Volts

4523 4524 4525

DYNODE No.1-TO-CATHODE VOLTS = 200
 VOLTS PER SUCCEEDING DYNODE STAGE EXCEPT FOR DYNODE-No. 5 STAGE = 100
 ANODE-TO-DYNODE No.10 VOLTS = 100
 FOCUSING-ELECTRODE VOLTAGE IS ADJUSTED TO THAT VALUE BETWEEN 50 AND 100 PER CENT OF DYNODE No.1 POTENTIAL (REFERRED TO CATHODE) WHICH PROVIDES MAXIMUM ANODE CURRENT.
 ANODE IS AT GROUND POTENTIAL.

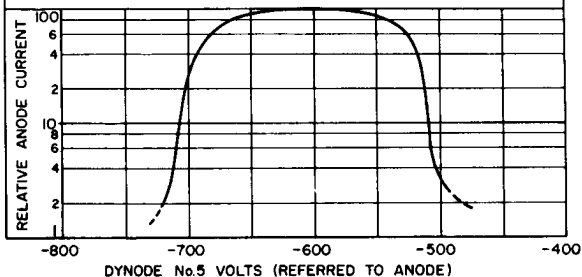

92CS-11078R1



Sensitivity and Current Amplification Characteristics

4523 4524

DYNODE NO. 1-TO-CATHODE VOLTS = $1/6 E$
 EACH SUCCEEDING DYNODE-STAGE VOLTS = $1/12 E$
 ANODE-TO-DYNODE NO. 10 VOLTS = $1/12 E$
 FOCUSING-ELECTRODE VOLTAGE IS ADJUSTED TO THAT VALUE
 BETWEEN 50 AND 100 PER CENT OF DYNODE-NO. 1 POTENTIAL
 (REFERRED TO CATHODE) WHICH PROVIDES MAXIMUM ANODE
 CURRENT.

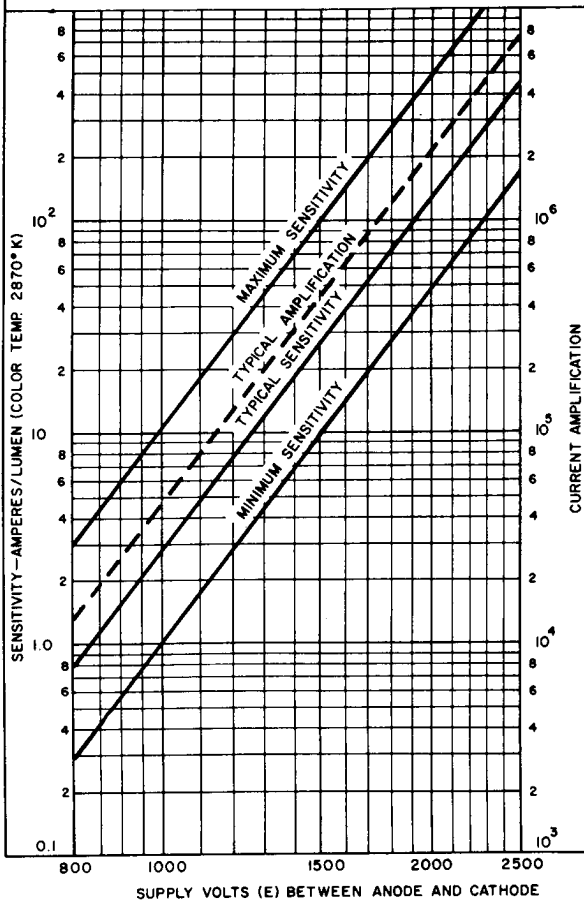

92LM-1583



Sensitivity and Current Amplification Characteristics

4525

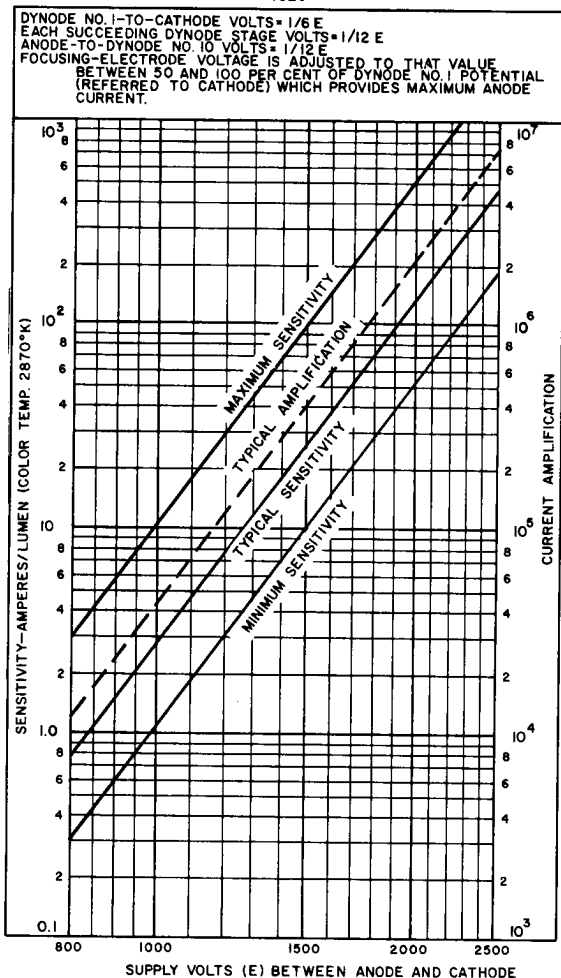

92LM-1753



Typical Anode Characteristics

4523 4524 4525

DYNODE NO. 1-TO-CATHODE VOLTS = 250
 EACH SUCCEEDING DYNODE-STAGE VOLTS = 125
 FOCUSING-ELECTRODE VOLTAGE IS ADJUSTED TO THAT VALUE
 BETWEEN 50 AND 100 PER CENT OF DYNODE-NO. 1 POTENTIAL
 (REFERRED TO CATHODE) WHICH PROVIDES MAXIMUM ANODE
 CURRENT
 LIGHT SOURCE IS A TUNGSTEN-FILAMENT LAMP OPERATED
 AT A COLOR TEMPERATURE OF 2870° K.

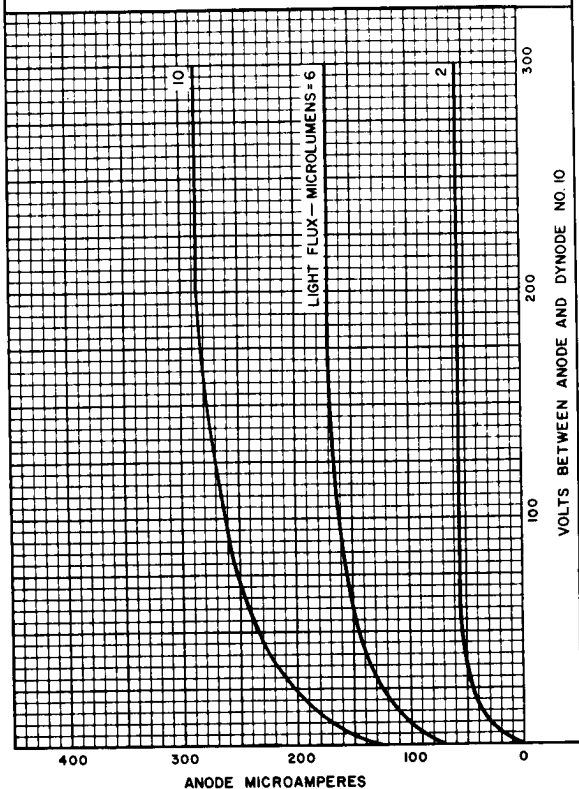

92LM-1555



Typical EADCI and Anode Dark Current Characteristics

4523

LUMINOUS SENSITIVITY IS VARIED BY ADJUSTMENT OF THE SUPPLY VOLTAGE (E)

DYNODE NO. 1-TO-CATHODE VOLTS = $1/6 E$

EACH SUCCEEDING DYNODE-STAGE VOLTS = $1/12 E$

ANODE-TO-DYNODE NO. 10 VOLTS = $1/12 E$

FOCUSING-ELECTRODE VOLTAGE IS ADJUSTED TO THAT VALUE BETWEEN 50 AND 100 PER CENT OF DYNODE NO. 1 POTENTIAL (REFERRED TO CATHODE) WHICH PROVIDES MAXIMUM ANODE CURRENT.

LIGHT SOURCE IS A TUNGSTEN-FILAMENT LAMP OPERATED AT A COLOR TEMPERATURE OF 2870° K.

TUBE TEMPERATURE = 22° C.

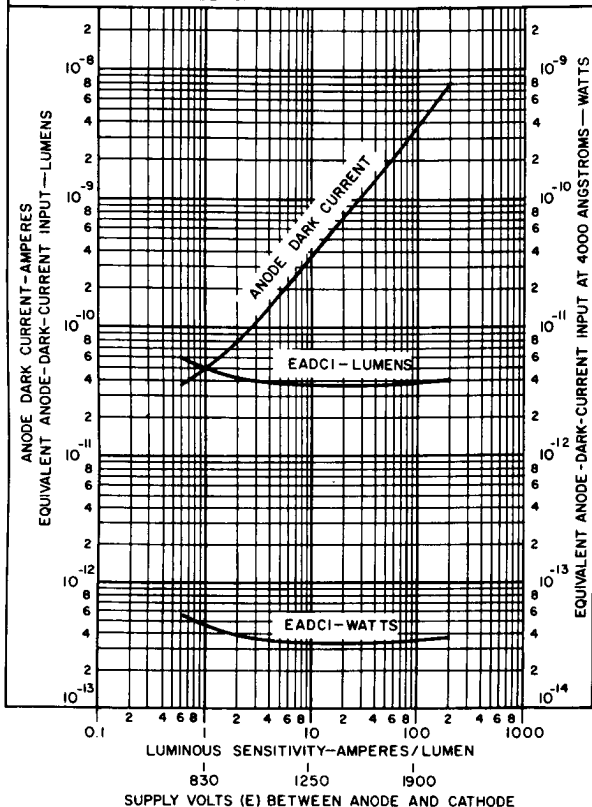

92LM-1777



RADIO CORPORATION OF AMERICA
Electronic Components and Devices Harrison, N. J.

DATA 9
2-67

Typical EADCI and Anode Dark Current Characteristics

4524

LUMINOUS SENSITIVITY IS VARIED BY ADJUSTMENT OF THE SUPPLY VOLTAGE (E).

DYNODE NO. 1-TO-CATHODE VOLTS = $1/6 E$

EACH SUCCEEDING DYNODE-STAGE VOLTS = $1/12 E$

FOCUSING—ELECTRODE VOLTAGE IS ADJUSTED TO THAT VALUE BETWEEN 50 AND 100 PER CENT OF DYNODE-NO. 1 POTENTIAL (REFERRED TO CATHODE) WHICH PROVIDES MAXIMUM ANODE CURRENT.

LIGHT SOURCE IS A TUNGSTEN-FILAMENT LAMP OPERATED AT A COLOR TEMPERATURE OF 2870°K.

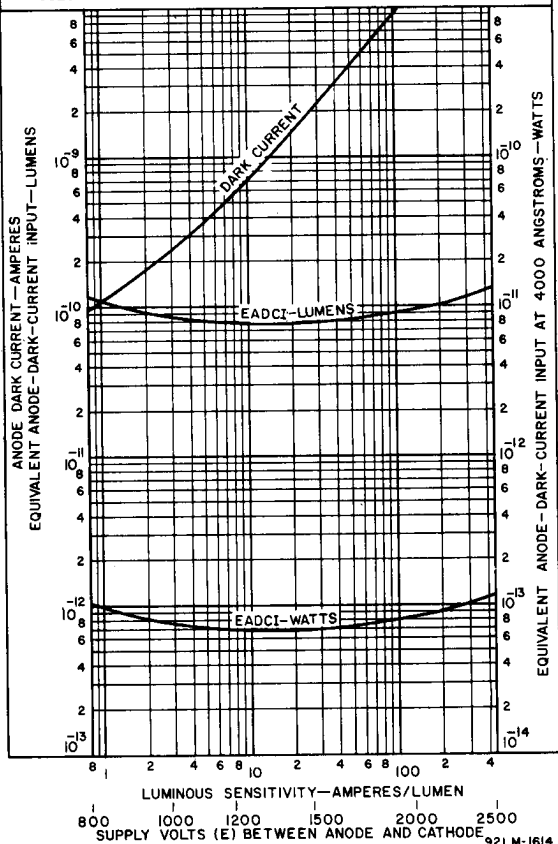

Typical EADCI and Anode Dark Current Characteristics

4525

LUMINOUS SENSITIVITY IS VARIED BY ADJUSTMENT OF THE SUPPLY VOLTAGE (E)

DYNODE NO. 1-TO-CATHODE VOLTS = $1/6 E$

EACH SUCCEEDING DYNODE-STAGE VOLTS = $1/12 E$

ANODE-TO-DYNODE NO. 10 VOLTS = $1/12 E$

FOCUSING-ELECTRODE VOLTAGE IS ADJUSTED TO THAT VALUE BETWEEN 50 AND 100 PER CENT OF DYNODE NO. 1 POTENTIAL (REFERRED TO CATHODE) WHICH PROVIDES MAXIMUM ANODE CURRENT.

LIGHT SOURCE IS A TUNGSTEN-FILAMENT LAMP OPERATED AT A COLOR TEMPERATURE OF 2870° K.
TUBE TEMPERATURE = 22° C.

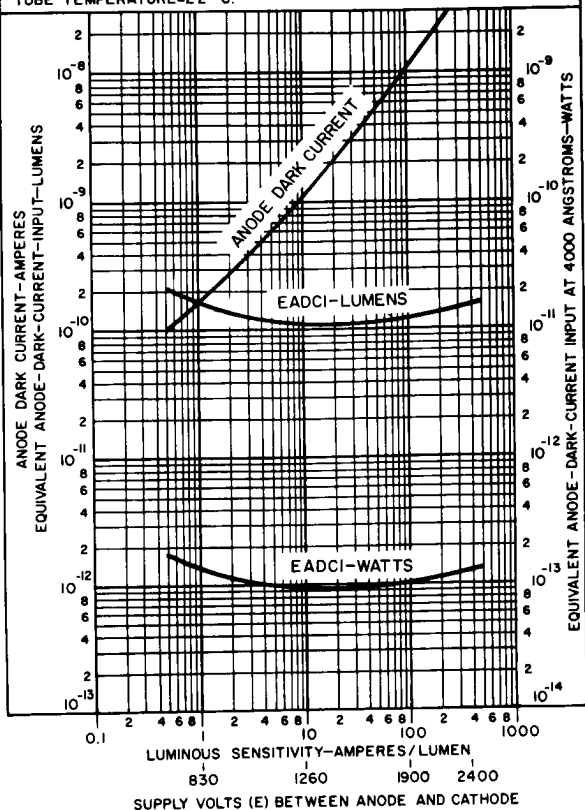

92LM-1752



RADIO CORPORATION OF AMERICA
Electronic Components and Devices

Harrison, N. J.

DATA 10
2-67

Typical Dark-Pulse Spectrum

4523

CATHODE-TO-DYNODE-NO.1 VOLTS = 430
 EACH SUCCEEDING DYNODE-STAGE VOLTS = 142
 ANODE-TO-CATHODE VOLTS = 1850
 FOCUSING-ELECTRODE VOLTAGE IS ADJUSTED TO THAT VALUE
 BETWEEN 50 AND 100 PER CENT OF DYNODE-NO. 1 POTENTIAL
 (REFERRED TO CATHODE) WHICH PROVIDES MAXIMUM ANODE
 CURRENT.
 DASHED PORTION INDICATES LOCATION OF SINGLE PHOTOELECTRON
 PEAK. THIS PORTION OF CURVE WAS OBTAINED WITH
 PHOTOCATHODE FULLY ILLUMINATED BY A TUNGSTEN-FILAMENT
 LAMP OPERATED AT A LOW COLOR TEMPERATURE. DARK PULSES
 WERE SUBTRACTED.
 SOLID-LINE PORTION INDICATES DARK-PULSE SPECTRUM.
 TUBE TEMPERATURE = 22° C.
 ONE-PHOTOELECTRON PULSE HEIGHT = 8 COUNTING CHANNELS.
 INTEGRATING TIME CONSTANT = 10 μ s, ($R_i = 100$ k Ω , $C = 100$ pF).

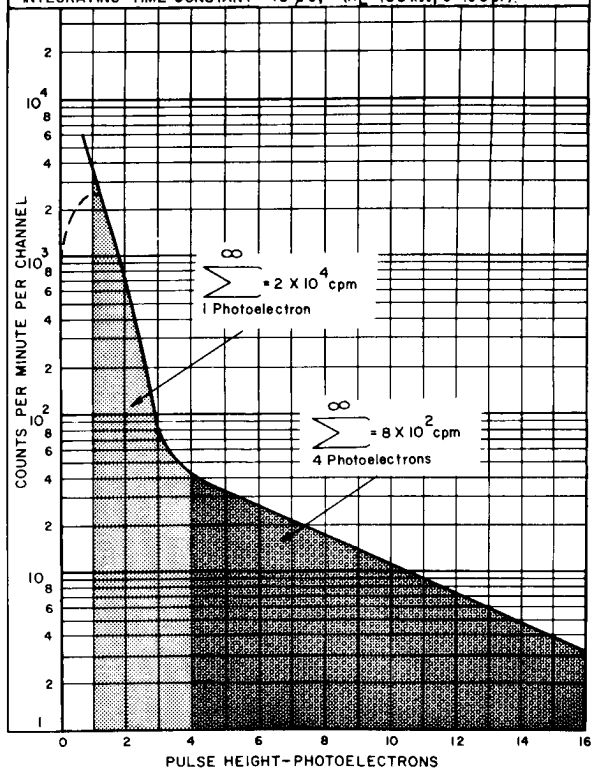

92LM-1778



Typical Dark-Pulse Spectrum

4524

CATHODE-TO-DYNODE-NO. 1 VOLTS = 430
 EACH SUCCEEDING DYNODE-STAGE VOLTS = 142
 ANODE-TO-CATHODE VOLTS = 1850
 FOCUSING-ELECTRODE VOLTAGE IS ADJUSTED TO THAT VALUE
 BETWEEN 50 AND 100 PER CENT OF DYNODE-NO. 1 POTENTIAL
 (REFERRED TO CATHODE) WHICH PROVIDES MAXIMUM ANODE
 CURRENT.
 DASHED PORTION INDICATES LOCATION OF SINGLE PHOTOELECTRON
 PEAK THIS PORTION OF CURVE WAS OBTAINED WITH
 PHOTOCATHODE FULLY ILLUMINATED BY A TUNGSTEN-FILAMENT
 LAMP OPERATED AT A LOW COLOR TEMPERATURE. DARK PULSES
 WERE SUBTRACTED.
 SOLID-LINE PORTION INDICATES DARK-PULSE SPECTRUM.
 TUBE TEMPERATURE = 22°C
 ONE-PHOTOELECTRON PULSE HEIGHT = 8 COUNTING CHANNELS.
 INTEGRATING TIME CONSTANT = 10 μ s. ($R_L = 100$ k Ω , $C = 100$ pF).

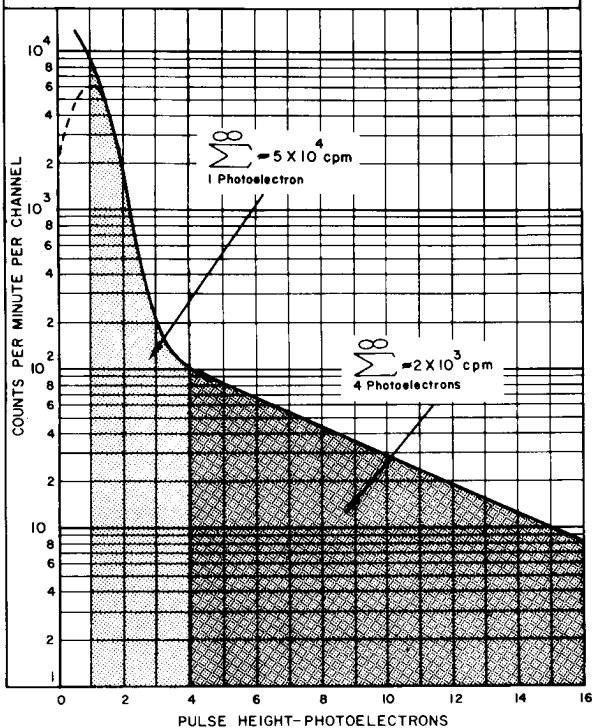

92LM-1615



Typical Dark-Pulse Spectrum

4525

CATHODE-TO-DYNODE-NO. 1 VOLTS = 430
 EACH SUCCEEDING DYNODE-STAGE VOLTS = 142
 ANODE-TO-CATHODE VOLTS = 1850
 FOCUSING-ELECTRODE VOLTAGE IS ADJUSTED TO THAT VALUE
 BETWEEN 50 AND 100 PER CENT OF DYNODE-NO. 1 POTENTIAL
 (REFERRED TO CATHODE) WHICH PROVIDES MAXIMUM ANODE
 CURRENT.
 DASHED PORTION INDICATES LOCATION OF SINGLE PHOTOELECTRON
 PEAK. THIS PORTION OF CURVE WAS OBTAINED WITH PHOTOCATHODE
 FULLY ILLUMINATED BY A TUNGSTEN-FILAMENT LAMP OPERATED AT
 A LOW COLOR TEMPERATURE. DARK PULSES WERE SUBTRACTED.
 SOLID-LINE PORTION INDICATES DARK-PULSE SPECTRUM.
 TUBE TEMPERATURE = 22° C
 ONE-PHOTOELECTRON PULSE HEIGHT = 8 COUNTING CHANNELS.
 INTEGRATING TIME CONSTANT = 10 μ s, (R_L = 100 kΩ, C = 100 pF).

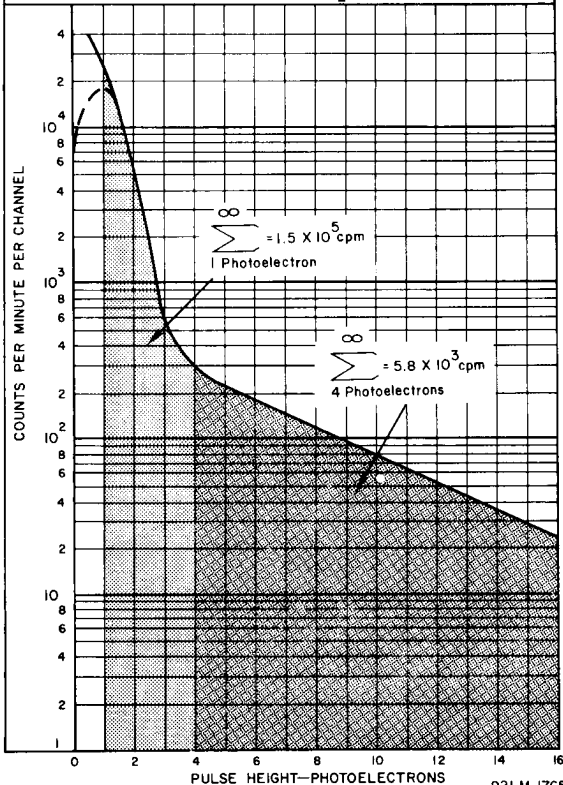

92LM-1765



Typical Effect of Magnetic Field on Anode Current

4523

DYNODE No. 1-TO-CATHODE VOLTS = AS INDICATED
 EACH SUCCEEDING DYNODE-STAGE VOLTS = 125
 ANODE-TO-DYNODE No. 10 VOLTS = 125
 FOCUSING-ELECTRODE VOLTAGE IS ADJUSTED TO THAT VALUE
 BETWEEN 50 AND 100 PER CENT OF DYNODE No. 1 POTENTIAL
 (REFERRED TO CATHODE) WHICH PROVIDES MAXIMUM ANODE
 CURRENT.
 PHOTOCATHODE FULLY ILLUMINATED BY A POINT LIGHT SOURCE
 POSITIONED APPROX. 1 FOOT FROM CENTER OF TUBE FACE.
 MAGNETIC FIELD PARALLEL TO MAJOR AXIS OF TUBE.

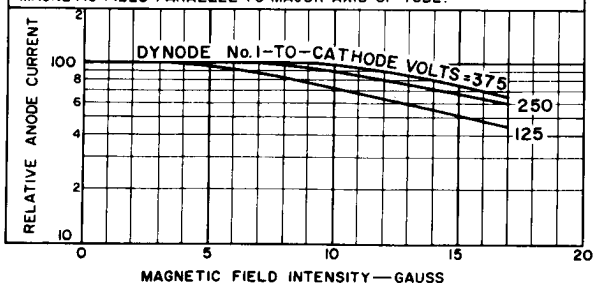

92CS-11235R2

Typical Effect of Magnetic Field on Anode Current

4523

DYNODE No. 1-TO-CATHODE VOLTS = AS INDICATED
 EACH SUCCEEDING DYNODE-STAGE VOLTS = 125
 ANODE-TO-DYNODE No. 10 VOLTS = 125
 FOCUSING-ELECTRODE VOLTAGE IS ADJUSTED TO THAT VALUE
 BETWEEN 50 AND 100 PER CENT OF DYNODE No. 1 POTENTIAL
 (REFERRED TO CATHODE) WHICH PROVIDES MAXIMUM ANODE
 CURRENT.
 PHOTOCATHODE FULLY ILLUMINATED BY A POINT LIGHT SOURCE
 POSITIONED APPROX. 1 FOOT FROM CENTER OF TUBE FACE.
 MAGNETIC FIELD PERPENDICULAR TO MAJOR AXIS OF TUBE.

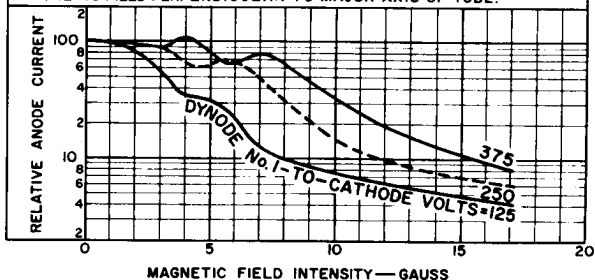

92CS-11236R2



Typical Effect of Magnetic Field on Anode Current

4524

DYNODE No.1-TO-CATHODE VOLTS=AS INDICATED
 EACH SUCCEEDING DYNODE-STAGE VOLTS=150
 ANODE-TO-DYNODE No.10 VOLTS=150
 FOCUSING-ELECTRODE VOLTAGE IS ADJUSTED TO THAT VALUE
 BETWEEN 50 AND 100 PER CENT OF DYNODE No.1 POTENTIAL
 (REFERRED TO CATHODE) WHICH PROVIDES MAXIMUM
 ANODE CURRENT.
 PHOTOCATHODE FULLY ILLUMINATED BY A POINT LIGHT SOURCE
 POSITIONED APPROX. 1 FOOT FROM CENTER OF TUBE FACE.
 MAGNETIC FIELD PARALLEL TO MAJOR AXIS OF TUBE.

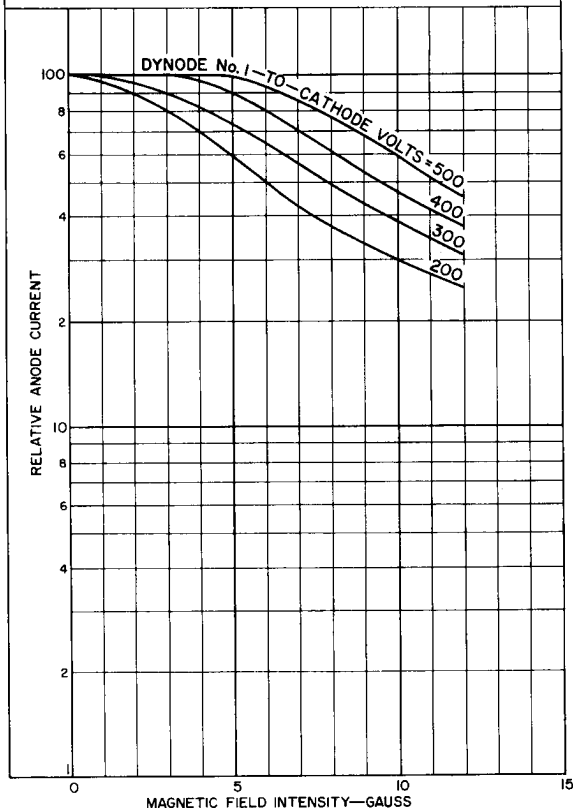

92CM-11084R3



Typical Effect of Magnetic Field on Anode Current

4524

DYNODE No.1-TO-CATHODE VOLTS=AS INDICATED
 EACH SUCCEEDING DYNODE-STAGE VOLTS=125
 ANODE-TO-DYNODE No.10 VOLTS=125
 FOCUSING-ELECTRODE VOLTAGE IS ADJUSTED TO THAT VALUE
 BETWEEN 50 AND 100 PER CENT OF DYNODE No.1 POTENTIAL
 (REFERRED TO CATHODE) WHICH PROVIDES MAXIMUM
 ANODE CURRENT.
 PHOTOCATHODE FULLY ILLUMINATED BY A POINT LIGHT SOURCE
 POSITIONED APPROX. 1 FOOT FROM CENTER OF TUBE FACE.
 MAGNETIC FIELD PERPENDICULAR TO MAJOR AXIS OF TUBE.

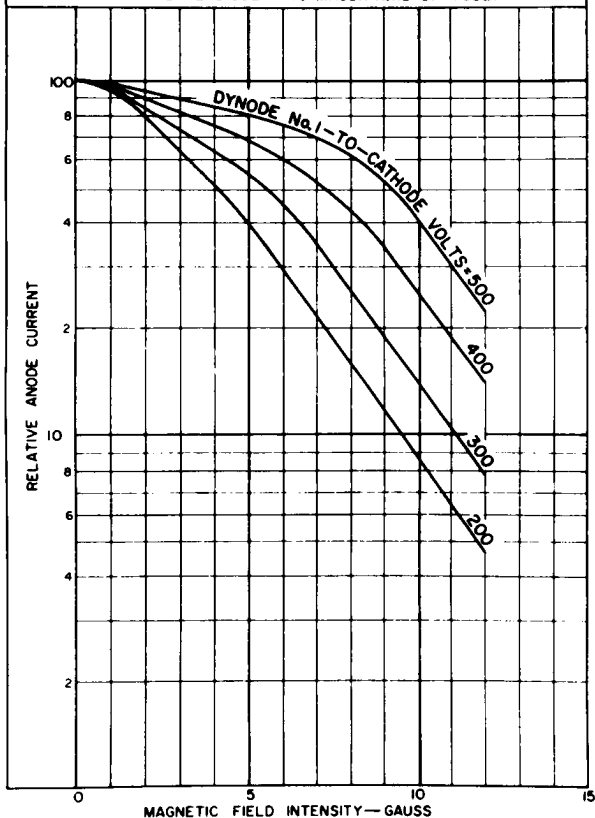

92CM-11085R2



Typical Effect of Magnetic Field on Anode Current

4525

DYNODE No.1-TO-CATHODE VOLTS = AS INDICATED
 EACH SUCCEEDING DYNODE-STAGE VOLTS = 125
 ANODE-TO-DYNODE No.10 VOLTS = 125
 FOCUSING-ELECTRODE VOLTAGE IS ADJUSTED TO THAT VALUE BETWEEN 50 AND 100 PER CENT OF DYNODE No.1 POTENTIAL (REFERRED TO CATHODE) WHICH PROVIDES MAXIMUM ANODE CURRENT.
 PHOTOCATHODE FULLY ILLUMINATED BY A POINT LIGHT SOURCE POSITIONED APPROX. 1 FOOT FROM CENTER OF TUBE FACE.
 MAGNETIC FIELD PARALLEL TO MAJOR AXIS OF TUBE.

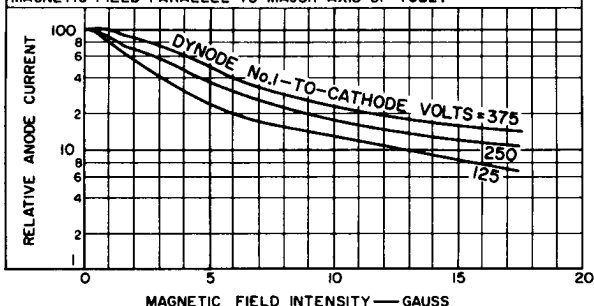

92CS-11187R2

Typical Effect of Magnetic Field on Anode Current

4525

DYNODE No.1-TO-CATHODE VOLTS = AS INDICATED
 EACH SUCCEEDING DYNODE-STAGE VOLTS = 125
 ANODE-TO-DYNODE No.10 VOLTS = 125
 FOCUSING-ELECTRODE VOLTAGE IS ADJUSTED TO THAT VALUE BETWEEN 50 AND 100 PER CENT OF DYNODE No.1 POTENTIAL (REFERRED TO CATHODE) WHICH PROVIDES MAXIMUM ANODE CURRENT.
 PHOTOCATHODE FULLY ILLUMINATED BY A POINT LIGHT SOURCE POSITIONED APPROX. 1 FOOT FROM CENTER OF TUBE FACE.
 MAGNETIC FIELD PERPENDICULAR TO MAJOR AXIS OF TUBE.

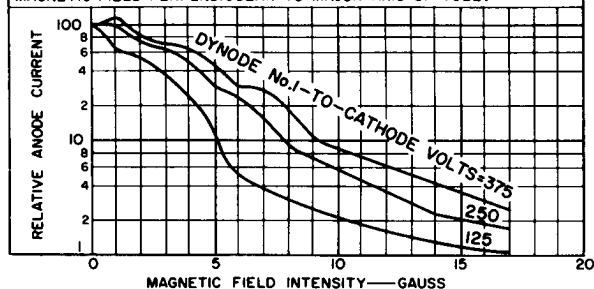

92CS-11188R2



Spectral Energy Distribution of 2870°K Light Source After Passing Through Indicated Filter

4523 4524 4525

SPECTRAL CHARACTERISTIC OF LIGHT FROM 2870° K SOURCE AFTER PASSING THROUGH BLUE FILTER (CORNING C.S. No.5-58 POLISHED TO 1/2 STOCK THICKNESS).
MAXIMUM FILTER TRANSMISSION OCCURS AT 4300 ANGSTROMS AND IS 60 PER CENT

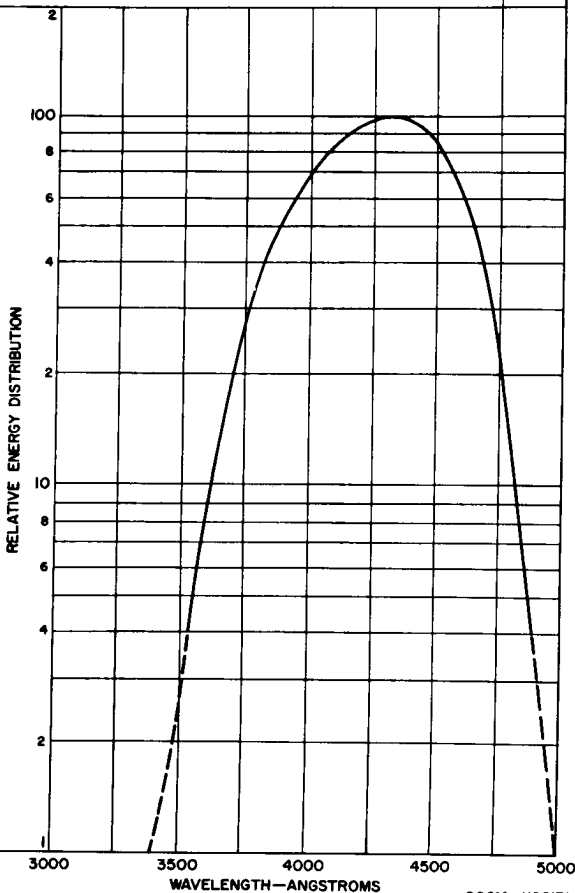

92CM-1108IRI



Typical Spectral Response Characteristics

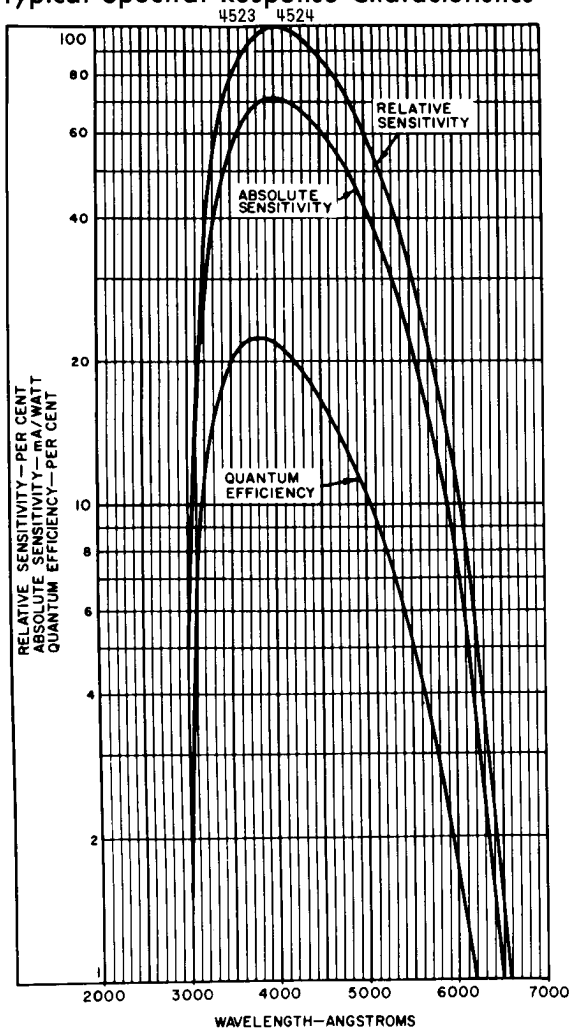

92LM-1158RI



Typical Spectral Response Characteristics

4525

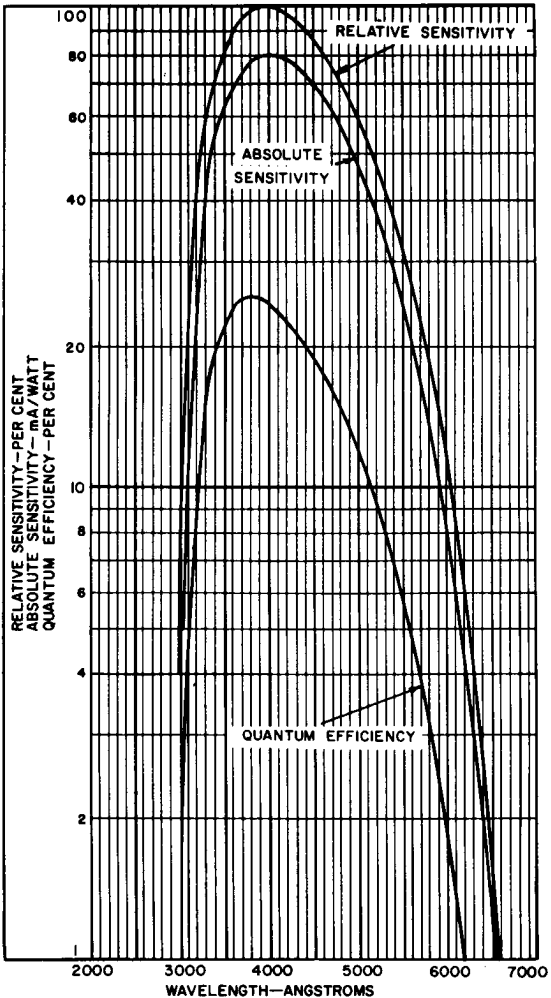

92LM-1779

