

# PHILIPS „MINIWATT“ ECH 3

## ECH 3

Röhrentype: Triode-Hexode, Mischröhre für Überlagerungs-empfänger.

Type de tube: triode-hexode, changeuse de fréquence pour superhétérodynes.

Type of tube: triode-hexode, frequency converter for superheterodyne receivers.

Heizung ind., Gleich- oder Wechselstrom,  
Parallel- oder Serienspeisung.

Chauffage ind., CA ou CC, alimentation  
en parallèle ou en série.

Heating ind., A.C. or D.C., parallel or  
series heater supply.

Vf 6,3 V  
If 0,200 A

Kapazitäten  
Capacités  
Capacities

a) Hexodenteil.

Partie hexode.

Hexode section.

Cg1 4,9  $\mu$ F  
Ca 9,0  $\mu$ F  
Cg1 <0,003  $\mu$ F  
Cglf <0,001  $\mu$ F

b) Triodenteil.

Partie triode.

Triode section

Cg 8,8  $\mu$ F  
Ca 4,4  $\mu$ F  
Cag 1,4  $\mu$ F

c) Zwischen Hexoden- und Triodenteil.

Entre les parties hexode et triode. Cg<sub>1</sub>g<sub>1H</sub> <0,3  $\mu$ F

Between hexode and triode section.

Betriebsdaten des Hexodenteiles als Mischröhre.

Caractéristiques de service de la partie hexode comme  
changeuse de fréquence.

Operating conditions for use of the hexode section  
as frequency changer.

a) Feste Schirmgitterspannung.

Tension de grille-écran fixe.

Fixed screen-grid voltage.

V <sub>ah</sub>	200			250	V
V <sub>g2,4</sub>	100			100	V
R <sub>k</sub>	215			215	$\Omega$
R <sub>g3</sub>	50000			50000	$\Omega$
I <sub>g3</sub>	200			200	$\mu$ A
V <sub>e1</sub>	-21	-17 <sup>2)</sup>	-23 <sup>3)</sup>	-21	-17 <sup>2)</sup> -23 <sup>3)</sup> V
I <sub>aH</sub>	3	-	-	3	-
I <sub>aH</sub>	3	-	-	3	-
I <sub>g2+I<sub>g4</sub></sub>	3	-	-	3	-
Sc	650	6,5	1,5	650	6,5 1,5 $\mu$ A/V
R <sub>i</sub>	0,9	> 5	> 5	1,3	> 5 > 6 M $\Omega$

b) Schirmgitterspeisung über einen Spannungsteiler.

Alimentation de la grille-écran à travers un po-  
tentiomètre.

Screen-grid supply through a potentiometer.

V <sub>ah</sub> = V <sub>b</sub>	250 V
R <sub>1</sub>	24000 $\Omega$
R <sub>2</sub>	33000 $\Omega$
R <sub>k</sub>	215 $\Omega$
R <sub>g3</sub>	50000 $\Omega$
I <sub>g3</sub>	200 $\mu$ A

**ECH 3****PHILIPS „MINIWATT”  
ECH 3**

Vg1	-2 <sup>1)</sup>	-23,5 <sup>2)</sup>	-31 <sup>3)</sup>	V
Vg2,4	100	-	145	V
IaH	3	-	-	mA
Ig2+Ig4	3	-	-	mA
Sc	650	6,5	1,5	µA/V
Ri	1,3	> 3	> 4	MΩ

c) Einstellung zur Erreichung eines guten Rauschverhältnisses, Schirmgitterspeisung über einen Spannungsteiler.

Conditions pour obtenir un bon rapport entre signal et souffle, alimentation des grilles-écran à travers un potentiomètre.

Conditions for obtaining a good signal to noise ratio, screen-grid supply through a potentiometer.

VaH = Vb		250		V
R1		47000		Ω
R2		33000		Ω
Rk		310		Ω
Rg3		50000		Ω
Ig3		200		µA
Vg1	-2 <sup>1)</sup>	-19 <sup>2)</sup>	-23 <sup>3)</sup>	V
Vg2,4	70	-	100	V
IaH	1,5	-	-	mA
Ig2+Ig4	1,6	-	-	mA
Sc	450	4,5	1,5	µA/V
Ri	2	> 5	> 6	MΩ

d) Günstigste Einstellung mit Rücksicht auf Quermodulation  
Speisung der Schirmgitter über einen Spannungsteiler.  
Conditions les plus favorable par rapport à la trans-  
modulation, alimentation des grilles-écran à travers  
un potentiomètre.

Optimum conditions for crossmodulation, screen-grid  
supply through a potentiometer.

VaH = Vb		250		V
R1		22000		Ω
R2		84000		Ω
Rk		165		Ω
Rg3		50000		Ω
Ig3		200		µA
Vg1	-2 <sup>1)</sup>	-28,5 <sup>2)</sup>	-40 <sup>3)</sup>	V
Vg2,4	125	-	200	V
IaH	4,5	-	-	mA
Ig2+Ig4	4,3	-	-	mA
Sc	800	8	1,5	µA/V
Ri	0,8	> 0,8	> 1,1	MΩ

e) Einstellung für Gebrauch in G/W-Empfängern.

Conditions pour l'utilisation dans des récepteurs  
tous courants.

Conditions for use in AC/DC receivers.

VaH = Vb		100	200	V
R1		19000	19000	Ω
R2		54000	54000	Ω
Rk		210	210	Ω
Rg3		50000	50000	Ω
Ig3		200	200	µA

# PHILIPS „MINIWATT” ECH 3

## ECH 3

Vg1	-1,25 <sup>1)</sup>	-13,5 <sup>2)</sup>	-16,5 <sup>3)</sup>	-2 <sup>1)</sup>	-23,5 <sup>2)</sup>	-31 <sup>3)</sup>	V
Vg2,4	55	-	75	100	-	145	V
Ia <sub>H</sub>	1	-	-	3	-	-	mA
Ig2+Ig4	1,4	-	-	3	-	-	mA
Sc	450	4,5	1,5	650	6,5	1,5	µA/V
Ri	1,3	> 4	> 5	0,9	> 2	> 2,5	MΩ

- 1) Im unregelmäßigen Zustand.  
Tube non réglée par le C.A.V.  
Tube not controlled by A.V.C.
- 2) Für eine Regelung der Mischsteilheit 1:100.  
Pour un réglage de la pente de conversion 1:100.  
For a control of the conversion conductance of 1:100.
- 3) Grenze des optimalen Regelbereiches.  
Limite de la zone de réglage optimum.  
Limit of the optimum control range.

Betriebsdaten des Triodenteiles als Oszillator.  
Caractéristiques de service de la partie triode comme oscillatrice.  
Operating conditions of the triode section as oscillator.

Vb	100	250	150 V
Ra <sub>T</sub>	-	45000	- Ω
Ia <sub>T</sub> (Rg <sub>T</sub> = 50000 Ω; Ig <sub>T</sub> = 200 µA)	3,3	3,3	8 mA
Ia <sub>T</sub> (Vg <sub>T</sub> = 0 V; Vosc = 0 V)	10	6,3	18 mA
S (Vg <sub>T</sub> = 0 V; Vosc = 0 V)	2,8	2,8	3,8 mA/V
µ (Vg <sub>T</sub> = 0 V; Vosc = 0 V)	24	24	24

Grenzdaten des Hexodenteiles.  
Limites fixées pour les caractéristiques de la partie hexode.  
Limiting values for operation of the hexode section.

Va <sub>H0</sub>	max. 550 V
Va <sub>H</sub>	max. 300 V
Wa <sub>H</sub>	max. 1,2 W
Vg2,4 <sub>0</sub>	max. 550 V
Vg2,4 (Ia = 4,5 mA)	max. 125 V
Vg2,4 (Ia ≤ 0,5 mA)	max. 200 V
Wg2,4	max. 0,6 W
Vg1 (Igl = +0,3 µA)	max. -1,3 V
Vg3 (Ig3 = +0,3 µA)	max. -1,3 V
Ik	max. 15 mA
Rglk	max. 3 MΩ
Rg3k	max. 100000 Ω
Rfk	max. 20000 Ω
Vfk	max. 100 V <sup>4)</sup>

- 4) Gleichspannung oder Effektivwert der Wechselspannung.  
Tension continue ou valeur efficace de la tension alternative.  
D.C. voltage or R.M.S. value of the A.C. voltage.

**ECH 3****PHILIPS „MINIWATT”  
ECH 3**

Grenzdaten des Triodenteiles.

Limites fixes pour les caractéristiques de la partie triode.

Limiting values for the triode section.

$V_{aT0}$	max. 550 V
$V_{aT}$	max. 150 V
$W_{aT}$	max. 1,5 W
$V_{gT}^{-1}$ ( $I_g = +0,3 \mu A$ )	max. -1,3 V
$R_g$	max. 100000 $\Omega$

Elektrodenanordnung, Sockelanschlüsse und max. Abmessungen in mm.

Disposition des électrodes, connexions du culot et dimensions max. en mm.

Electrode arrangement, base connections and max. dimensions in mm.

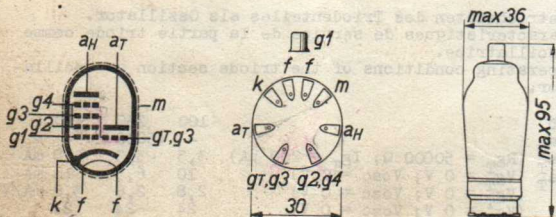

Grundsätzliche Betriebsschaltung.

Schema de principe d'utilisation.

Fundamental circuit diagram for operation.

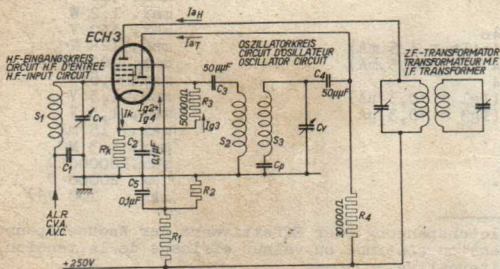

# PHILIPS „MINIWATT“

ECH 3

## ECH 3

$I_{aH} (\mu A)$

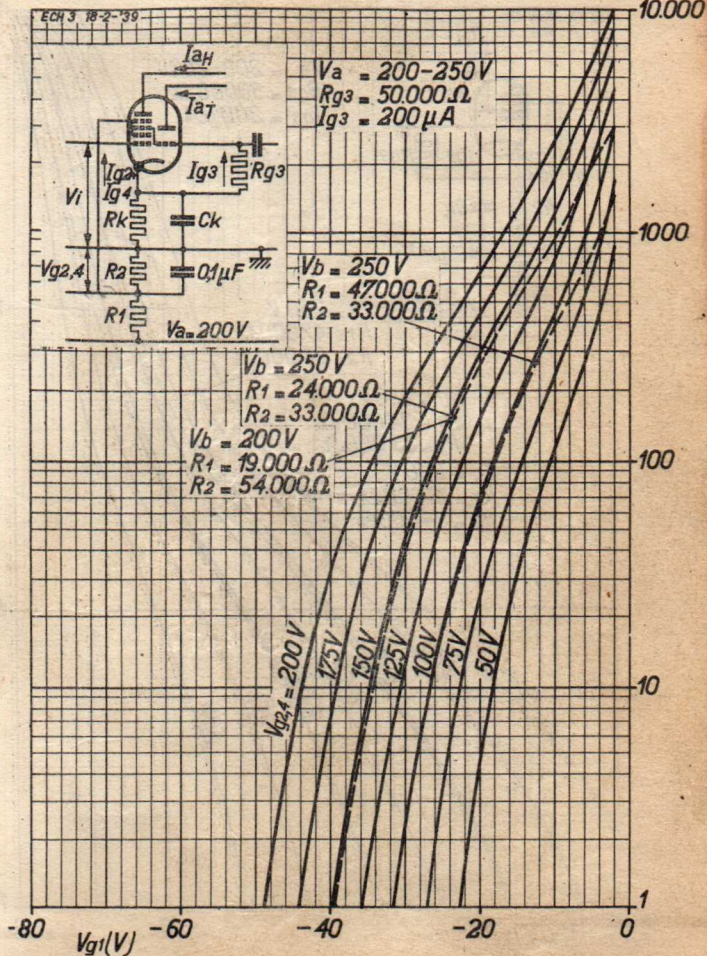

**ECH 3****PHILIPS „MINIWATT“****ECH 3** $Sc(\mu A/V)$ 

1000

ECH 3 18-2-39

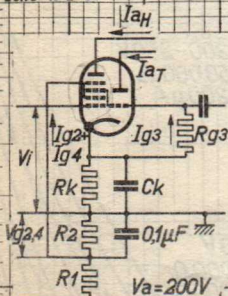

$V_a = 200-250V$   
 $R_{g3} = 50000\Omega$   
 $I_{g3} = 200\mu A$

$V_b = 250V$   
 $R_1 = 47.000\Omega$   
 $R_2 = 33.000\Omega$

$V_b = 250V$   
 $R_1 = 24.000\Omega$   
 $R_2 = 33.000\Omega$

$V_b = 200V$   
 $R_1 = 19.000\Omega$   
 $R_2 = 54.000\Omega$

100

10

1

$V_{g1} (V)$  -40 -30 -20 -10 0

$V_{g2} = 200V$   
 175V  
 150V  
 125V  
 100V  
 75V  
 50V

# PHILIPS „MINIWATT“

ECH 3

ECH 3

$I_{aH} (\mu A)$   
10.000

ECH 3 18-2-'39

$V_a = 100V$   
 $R_{g3} = 50.000\Omega$   
 $I_{g3} = 200 \mu A$

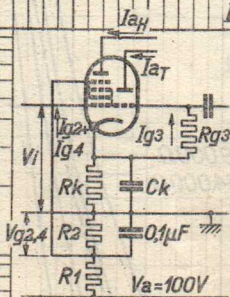

$R_1 = 19.000\Omega$   
 $R_2 = 54.000\Omega$

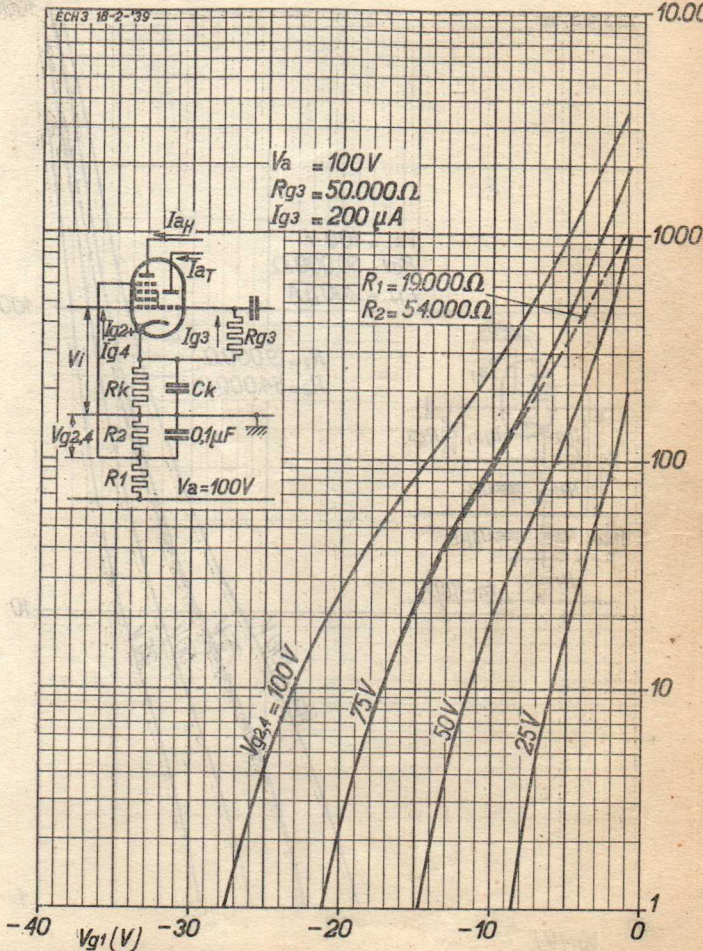

**ECH 3****PHILIPS „MINIWATT“****ECH 3** $S_c (\mu A/V)$ 

ECH 3 18-2-'39

$V_a = 100 V$   
 $R_{g3} = 50.000 \Omega$   
 $I_{g3} = 200 \mu A$

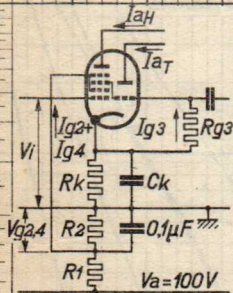

$R_1 = 19.000 \Omega$   
 $R_2 = 54.000 \Omega$

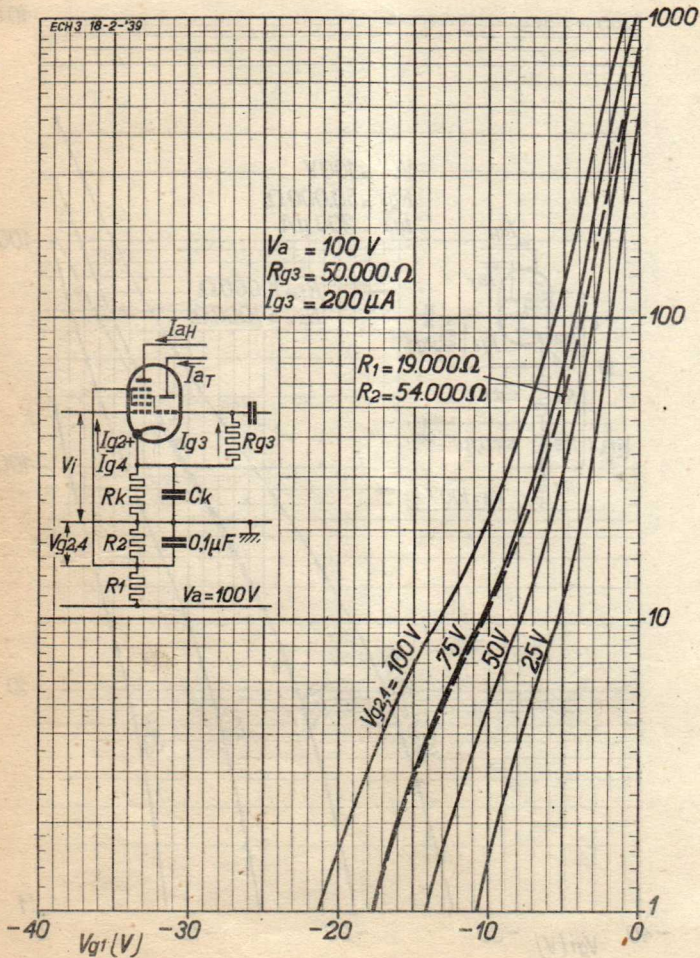

# PHILIPS „MINIWATT“

**ECH3**

## ECH3

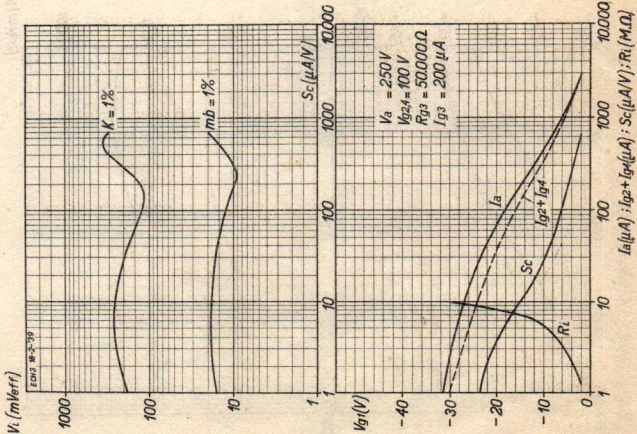
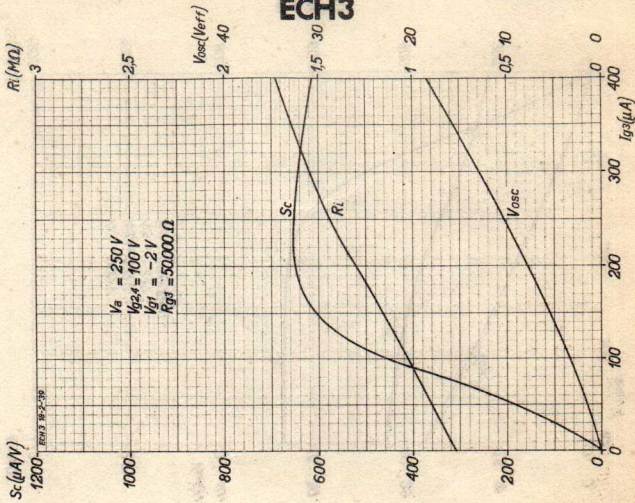

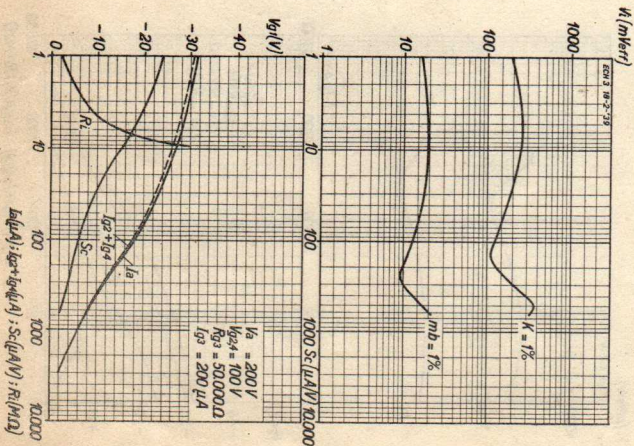
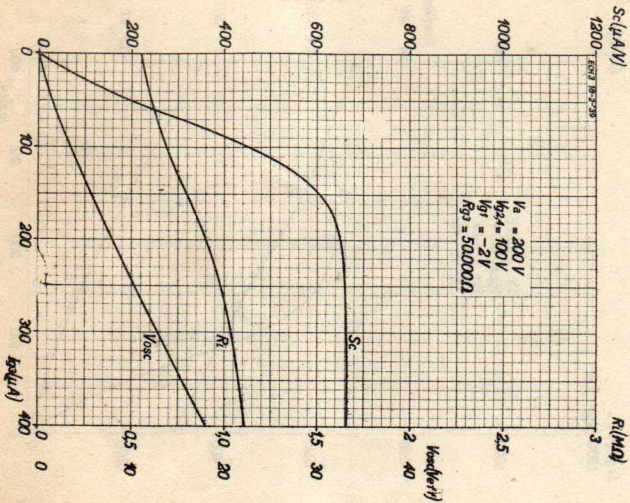
**ECH3****PHILIPS „MINIWATT“****ECH3**

# PHILIPS „MINIWATT“ ECH 3

**ECH 3**

$S_c(\mu A/V)$

$R_i(M\Omega)$

1200

3

ECH 3 18-2-39

1000

800

600

400

200

0

$V_b = V_a = 250V$   
 $R_k = 215\Omega$   
 $R_1 = 24.000\Omega$   
 $R_2 = 33.000\Omega$   
 $R_{g3} = 50.000\Omega$

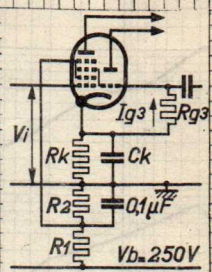

2,5

2

$V_{osc}(V_{eff})$

1,5 30

1 20

0,5 10

0 0

$S_c$

$R_i$

$V_{osc}$

0 100 200 300 400  $I_{g3}(\mu A)$

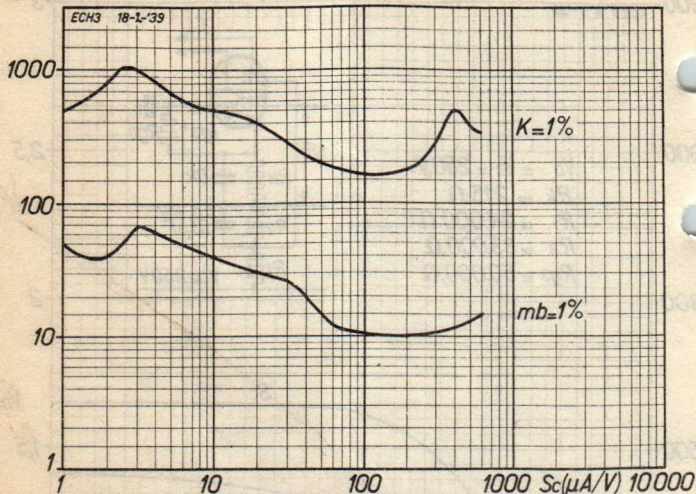
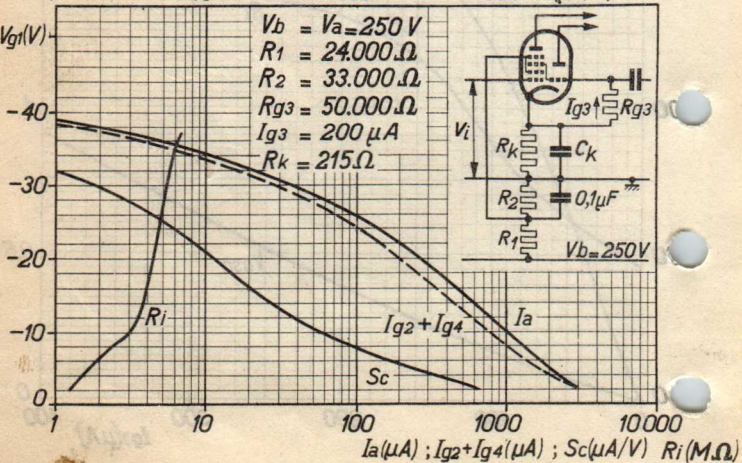
**ECH 3****PHILIPS „MINIWATT“****ECH 3** $V_i(\text{mVeff})$  $V_{g1}(\text{V})$ 

# PHILIPS „MINIWATT“

ECH 3

## ECH 3

$S_c(\mu A/V)$

$R_i(M\Omega)$

1200

6

ECH 3 10-2-39

$V_b = V_a = 250 V$   
 $V_{g1} = -2 V$   
 $R_1 = 47.000 \Omega$   
 $R_2 = 33.000 \Omega$   
 $R_{g3} = 50.000 \Omega$

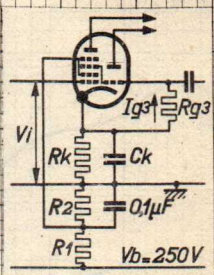

1000

5

800

4

600

$V_{osc}(V_{eff})$

400

200

0

3 30

2 20

1 10

0 0

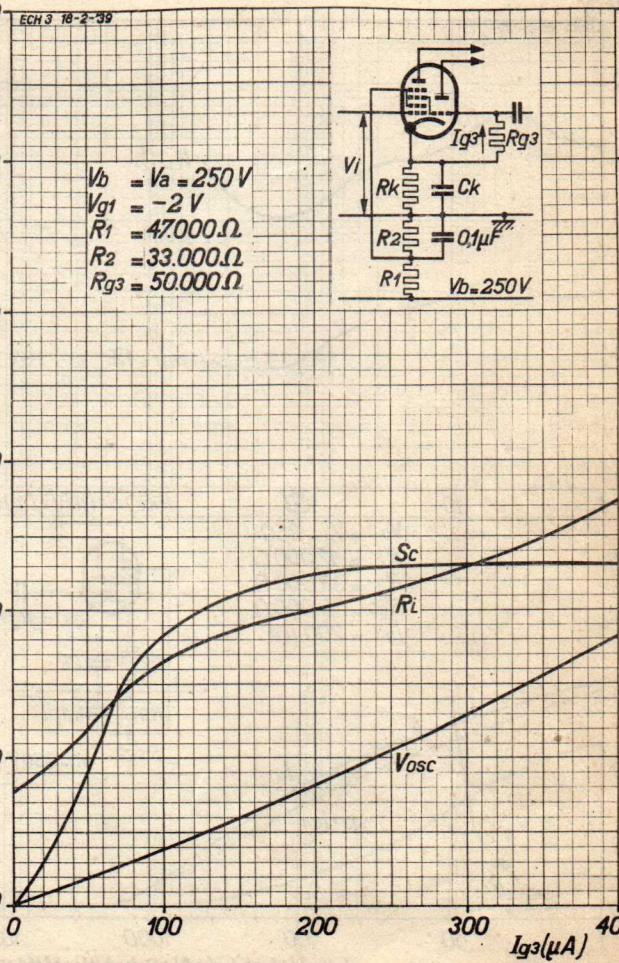

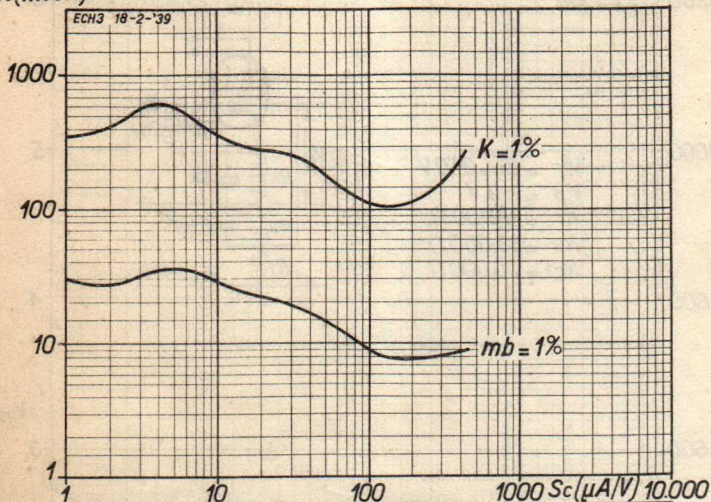
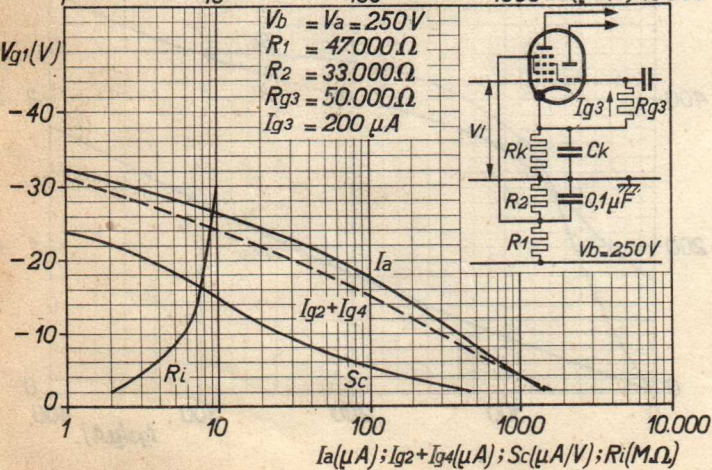
**ECH 3****PHILIPS „MINIWATT“****ECH 3** $V_i$  (mV<sub>eff</sub>) $V_{g1}$  (V)

# PHILIPS „MINIWATT“

**ECH 3**

## ECH3

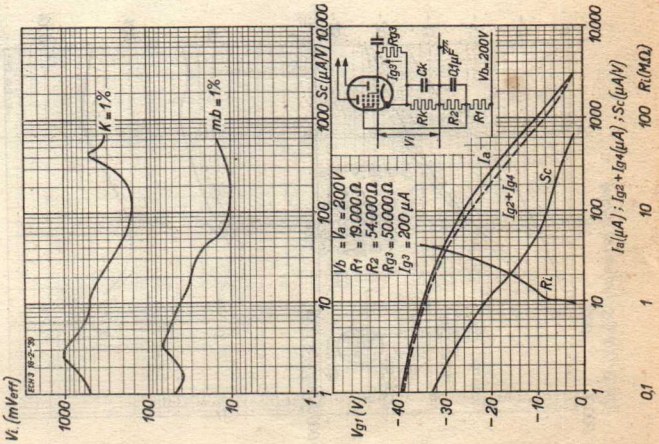
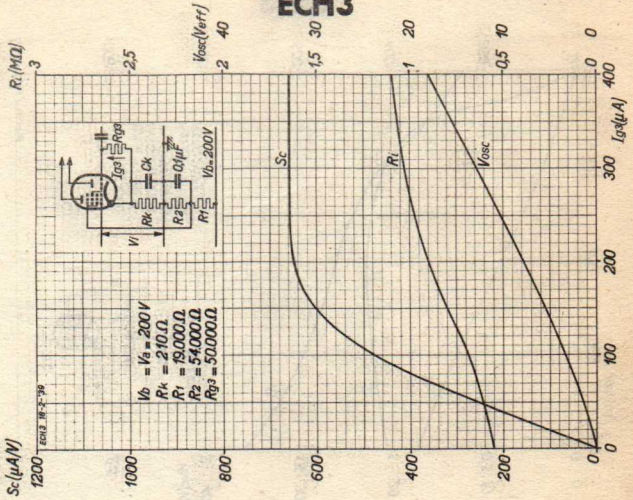

ECH3

PHILIPS „MINIWATT“

ECH3

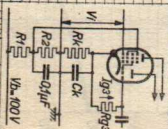
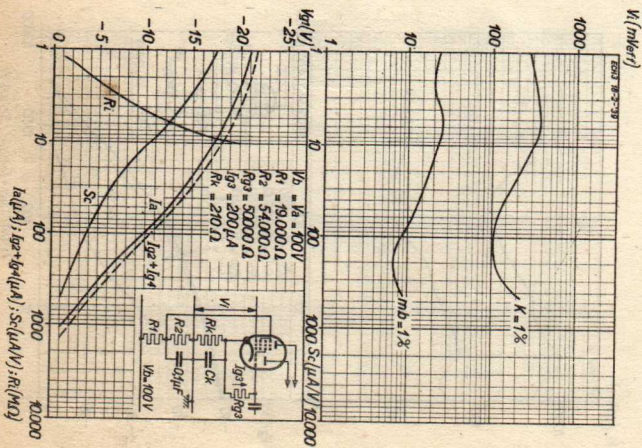
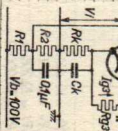
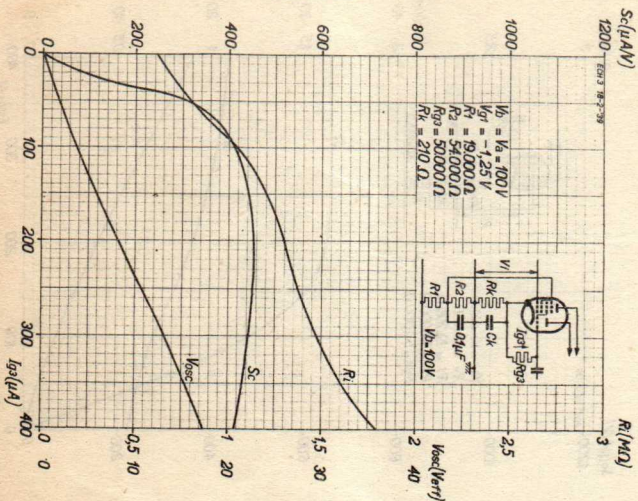

$I_{q1}(\mu A); I_{q2} + I_{gr}(\mu A); S_c(\mu A/V); R_i(M\Omega)$

# PHILIPS „MINIWATT“

**ECH 3**

## ECH 3

