

**COSSOR**  
**VALVE MANUAL**  
**1935-6**

# **COSSOR**

## **VALVE MANUAL**

### **1935-6**



KINGS OF THE AIR

A. C. COSSOR, LTD.  
COSSOR WORKS  
HIGHBURY GROVE  
LONDON, N.5

# A. C. COSSOR LTD.

*Head Office :*

**Cossor Works, Highbury Grove**

**LONDON N.5**

Telephone : Canonbury 1234 (20 lines)

Telegrams : Amplifiers, Phone, London.

*Works :*

<b>COSSOR WORKS :</b>	<b>Highbury Grove, N.5.—Cossor Valves</b>
<b>ABERDEEN WORKS :</b>	<b>Aberdeen Lane, N.5.—Electric Lamps and Signs.</b>
<b>KELVIN WORKS :</b>	<b>Kelvin Road, N.5.—Cossor Radio Receivers.</b>
<b>MELODY ENGINEERING WORKS :</b>	<b>N.5.</b>
<b>No. 5 WORKS :</b>	<b>Highbury Grove, N.5. — Components and Receivers.</b>
<b>CABINET WORKS :</b>	<b>Leyton, E.10.</b>

## **DISTRIBUTING & SERVICE DEPOTS AT**

**AT**

### **BIRMINGHAM**

14/16 Carrs Lane (4) ..... Tel. Midland 1627/8  
Telegrams : Amplifiers, Birmingham.

### **BRISTOL**

14 Bath Street (1) ..... Tel. Bristol 20271/2  
Telegrams : Amplifiers, Bristol.

### **GLASGOW**

21 Waterloo Street (C2) ..... Tel. Central 4446/7  
Telegrams : Amplifiers, Glasgow.

### **LEEDS**

17 Wellington Street (1) ..... Tel. Leeds 21581/2  
Telegrams : Cossor, Leeds.

### **LIVERPOOL**

42 Paradise Street (1) ..... Tel. Central 1877/8  
Telegrams : Amplifiers, Liverpool.

### **MANCHESTER**

6, 8 & 10 Cannon St. (3) ..... Tel. Blackfriars 9777/8/9  
Telegrams : Amplifiers, Manchester.

### **NEWCASTLE**

3 St. Nicholas Bldgs. (1) ..... Tel. Newcastle 23154/5  
Telegrams : Amplifiers, Newcastle.

### **SHEFFIELD**

3 Porter Street, Moorhead (1) ..... Tel. Sheffield 23103/4  
Telegrams : Amplifiers, Sheffield.

### **BELFAST**

47 Queen Street ..... Tel. Belfast 7979  
Telegrams : Amplifiers, Belfast.

### **CARDIFF**

4 Park Lane ..... Tel. Cardiff 172/3  
Telegrams : Amplifiers, Cardiff.

### **DUBLIN**

47b Fleet Street (Parliament Row) .... Tel. Dublin 22471

# Foreword

*FOR over twenty years we have specialised in the manufacture of high vacuum products including wireless valves, cathode ray oscillograph tubes, X-ray tubes, electric lamps, etc., and, backed by that lengthy experience, the valves listed herein represent the most advanced practice in this sphere of radio technique.*

*The adoption of Mica Bridge Construction and Multi-point Filament Suspension (both developments emanating from our own research laboratories) has resulted in a range of valves possessing the highest possible standard of efficiency combined with remarkable consistency.*

*Each type of valve is designed to fulfil a specific function, and meticulous care in manufacture together with most rigorous tests ensure uniformity of product.*

*Further details regarding any valves manufactured by us will be sent on application to our Technical Service Department.*

The  
VALVE <sup>of</sup> WORKS  
A.C. COSSOR LTD  
HIGHBURY, LONDON.

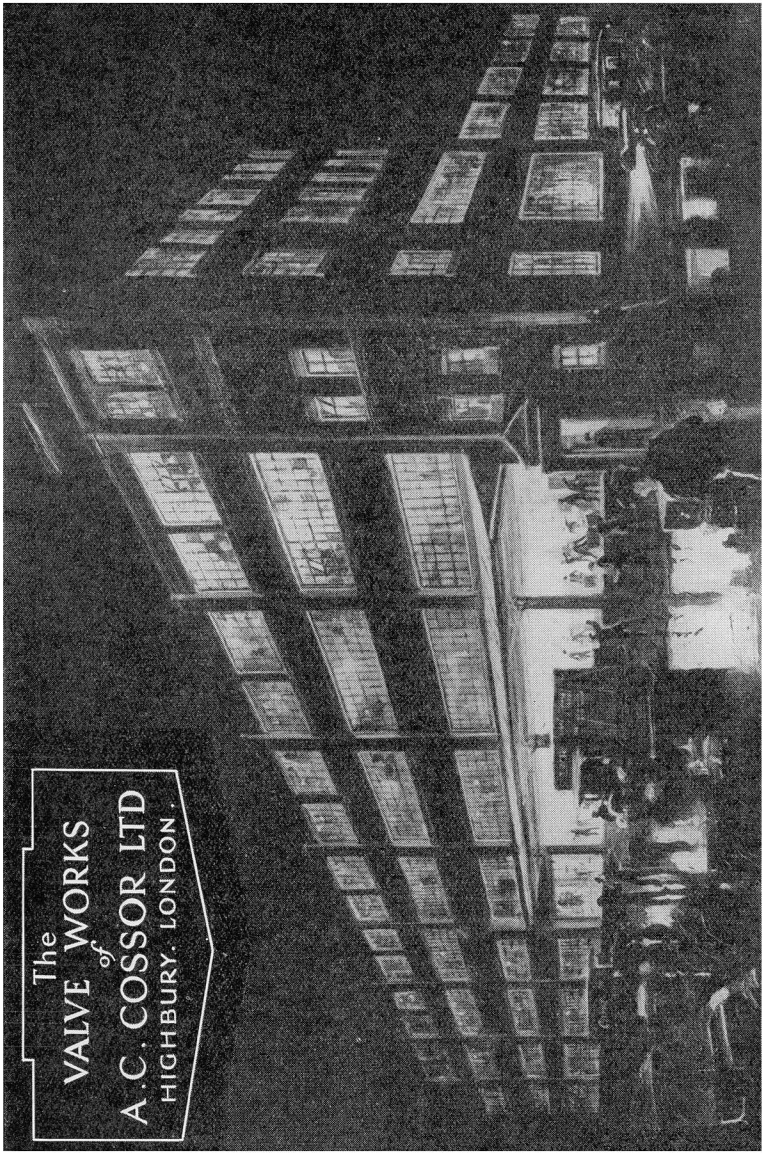

# CONTENTS

---

	<i>Pages</i>
Valve Fundamentals .. .. .	7-10
Cossor Valve Construction .. .. .	11-17
Types of Valves and their uses .. .. .	18-21
Characteristics .. .. .	22-25
Applications :—	
The H.F. Stage .. .. .	26-27
Detection .. .. .	28
Output .. .. .	29-30
Class “B” Output .. .. .	31-34
A.V.C. .. .. .	34-36
The Superheterodyne .. .. .	37-39
Useful Valve Formulae .. .. .	40-41
Cossor Valves and their Connections .. .. .	42-43
Cossor Valve Data :—	
2-Volt Battery Valves .. .. .	44-64
4-Volt Mains Valves .. .. .	65-83
·2 amp. Mains Valves .. .. .	84-90
16-Volt Mains Valves .. .. .	91-98
Neon Tuning Indicators .. .. .	99
Voltage Stabilizer .. .. .	99
Rectifiers .. .. .	100-101
Cossor Valves : Tabulated Data .. .. .	102-108
Cossor Valve Equivalents .. .. .	109-111
Cossor Valves for Cossor Kits and Receivers .. .. .	112-113
Cossor Valves for Commercial Receivers .. .. .	114-126
Useful Circuits .. .. .	127-136



# COSSOR VALVE MANUAL

---

## VALVE FUNDAMENTALS

*Being a short resumé of the principles underlying the working of the Thermionic Valve.*

Modern thermionic valves have progressed a long way from the simple diode valve first used by Prof. J. A. Fleming between 1890 and 1896 for detection of high frequency oscillations. Yet all have developed as a consequence of the work carried out by him.

Prior to Prof. Fleming's discovery, work by physicists both in America and Europe had resulted in the discovery that certain substances, particularly metals, had the property of emitting charged particles when heated in a vacuous space. These particles were apparently negatively charged since they could be collected by a positively charged plate of metal but not by a negatively charged one. It is now established, of course, that these particles are electrons.

## EARLY DISCOVERIES

The essential fact, however, upon which Prof. Fleming fixed was that an evacuated device consisting of an electrically heated wire and of a collector electrode in the form of a plate, would conduct electricity only in one direction, i.e. when the collector electrode was made positive. This, he realised, implied that such a device could be used to convert alternating current into direct current and had particular application to rectifying high frequency oscillations. He was led to experiment in this field and his results were completely successful.

Fleming's work had thus provided an efficient and reliable method of rectifying high frequency waves. As yet, however, no method was known of amplifying small variations in voltage except by means of transformers. In 1907 Lee de Forest con-



ceived the idea of introducing between the heated wire and the collector electrode a mesh of wires. He found that very small variations in potential impressed upon this mesh had the effect of controlling the current flowing to the collector electrode. If this current were made to flow through some form of resistance, potential variations appeared across the resistance in synchronisation with the variation impressed upon the wire mesh and of much larger magnitude. Thus he had achieved a new and convenient method of amplifying small alternating voltages.

## FLEMING AND DE FOREST

These two fundamental discoveries, one by Fleming and the other by De Forest, have been directly responsible for the extraordinary advances which have been made in wireless telegraphy and telephony since 1907. To-day all forms of thermionic valves are fundamentally similar to those used by Fleming or De Forest. They contain a heated electrode known as the "filament" or "cathode," at least one collector electrode known as the "anode," and one or more meshes of wire known as the "grid" or "grids." We shall proceed to discuss these electrodes and their relation to modern valves.

## THE FILAMENT

An enormous amount of work has been carried out by physicists and valve engineers on the material used for the filament or cathode.

In almost all Cossor valves the filament consists of a core wire covered with a coating made of a mixture of the oxides of certain of the alkaline earth metals. These oxides, among other peculiarities, have the property of emitting an enormous number of electrons when heated to only a dull red. In addition, these oxides have the further advantage of supplying their emission for an almost unlimited time. Thus it may be seen that on all counts this type of filament is eminently satisfactory for commercial use.

It may not be generally realised that the mass of electrons emitted by a filament may be considerably in excess of the actual mass of the filament coating. As an example, a Cossor Valve having a 2-volt .1 amp. filament run at an anode current of 7 m.a. for 20,000 hours represents a passage through the valve of a number of electrons having a total mass of approximately 1.5 milligrams. The total mass of the actual active coating in such a filament is 0.4 milligrams, so that the mass of electrons leaving the filament actually exceeds the total mass of the filament coating. A filament such as is described above is used in all Cossor battery valves. In the case of A.C. mains valves a somewhat different technique is required. Here the source of electrons is heated by A.C. current, and if it is of a filamentary character considerable hum is likely to result in the output from the receiver. Hence an "indirectly heated" cathode is used for these valves. This

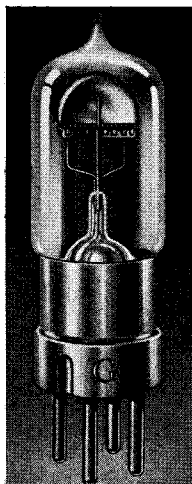

*An early type of  
Cossor Valve*

consists of a hollow nickel tube of circular or flattened section, which is coated on its outside with the usual alkaline earth oxides. A connection is provided to this cathode and it is heated to a temperature adequate for full emission by means of an insulated wire "hairpin" inside it. The alternating current passes through this wire only, and the insulating material coating the "hairpin" is a good non-conductor even at elevated temperatures. Hence no hum results due to the alternations of the supply being applied to the cathode.

## THE ANODE

The "collector electrode" now consists of an anode of a more or less complicated design depending upon the type of valve in

which it is used. This anode receives all or the bulk of the electrons emitted from the cathode and the "bombarding effect" of this stream of miniature bullets tends to raise its temperature. In consequence the anode in any thermionic valve must be large enough in area to dissipate the heat generated by this bombardment without an undue rise in temperature. The anode is usually in the form of an enveloping box containing the cathode and grids, and in receiving valves it is usually an easy matter to ensure adequate heat dissipation from its surface. In certain cases, carbon deposited on the surface of the anode helps this, and it may be observed that certain Cossor output valves use anodes so treated.

## EXTRA ELECTRODES

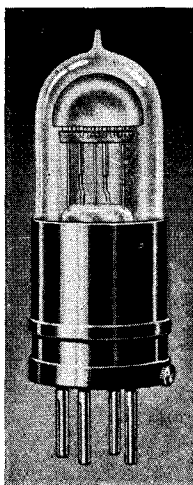

*A Cossor Wuncell—Representing a development which had far reaching effects on valve design and progress*

The purpose of a grid, as has been explained, is, in general, to affect or control the flow of electrons from cathode to anode. In addition, however, multi-electrode valves often include grid electrodes, which are maintained at a fixed potential and are used to impart to the valve in question some desired characteristic particularly suited to the use made of the valve. In addition, such an electrode may serve to reduce the capacity between two other electrodes between which it is interposed. Such grids are known as "screens," "accelerating grids" or "suppressor grids."

In the succeeding sections descriptions will be given of the constructional details and uses of the many types of valves now manufactured.

# COSSOR VALVE CONSTRUCTION

## PRESENT-DAY VALVE DESIGN

As an interesting example, we show a sectional illustration of a typical battery-operated Cossor Valve. First of all, a word about the filament. The efficiency of a valve depends very largely upon the electronic emission from its filament. The Cossor filament consists of a very tough metallic core on which is deposited a coating capable of emitting a very prolific stream of electrons at an exceptionally low temperature.

The fact that the Cossor filament functions practically without visible glow ensures consistent service from the valve. For obviously if it were necessary to heat up the filament to incandescence to drive off the electrons, such excessive heat would set up crystallization in the metal and ultimately cause a premature fracture.

So much, therefore, for the strong, economical and efficient Cossor filament. Examining the illustration more closely it will

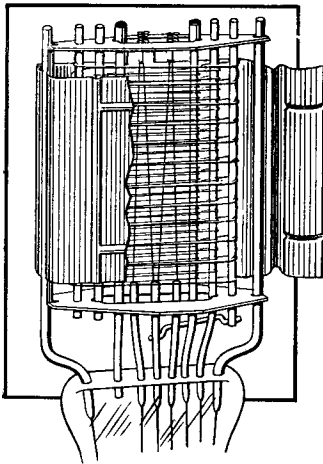

Cossor 220 H.P.T.

be noticed that the grid and the anode are mounted on very stout vertical supports, the ends of which project slightly through a mica bridge piece secured to the anode.

## COSSOR MICA BRIDGE ASSEMBLY

There are very important advantages to be obtained from this construction. First of all, it is enormously strong. Even the hardest blow cannot disturb any individual electrode. All are

firmly locked together in absolute alignment. Again, it ensures extreme accuracy in assembly. No deviation is possible. The holes in the mica bridge piece are accurate to a thousandth part of an inch. The distances between filament, grid and anode, therefore, remain consistent in all valves of the same class—thus ensuring a remarkable degree of uniformity.

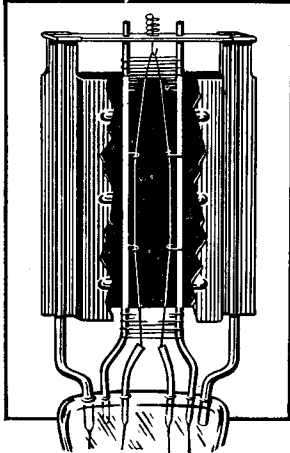

**Cossor Triode Valve.** *Showing multiple filament suspension system.*

The loud speaker carried either through the air or through the valve pins are inevitably sufficient to initiate the vibration which rapidly builds up. The Cossor system cures this nuisance by damping out filament vibration at its source.

## **MULTIPLE FILAMENT SUSPENSION**

It will be noticed that the mica bridge and four insulated hooks welded to the grid supports provide a very precise anchorage for the filament. In this manner a multiple filament suspension system has been evolved which completely eliminates microphonic noises. It has been proved that microphonic noises are almost always caused by the filament vibrating at its natural frequency. Impulses from the

## **THE DESIGN OF THE COSSOR GRID**

With the evolution of more elaborate types of valves possessing several grids, a short description of the way in which Cossor Grids are made will be of interest. Cossor Grids are manufactured automatically in a very ingenious machine. On each of the two grid supports are cut the requisite number of slots at carefully calculated intervals. The actual cutting of the slot raises a small ridge. The grid wire is wound into these slots with great accuracy. Finally, the ridges are turned down and each turn of the wire is firmly secured in its slot. This is a tremendous improvement over electric welding—the method

previously used. When electric welding is used it may happen that one turn, not being properly welded, comes adrift. The result is a loose wire, with a consequent risk of microphonic noises or altered characteristics. Every Cossor Grid is slot wound with a very high degree of accuracy. This is one reason why Cossor Valves function with such an absence of mechanical noise.

## COSSOR SCREENED GRID VALVES

Cossor was one of the first manufacturers to introduce a Screened Grid Valve, and the long lead that they had has enabled them to continually improve the design of this valve. It is not possible within the space available to go very deeply into the technicalities of Screened Grid Valve design.

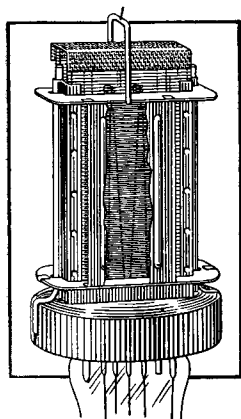

Cossor 220 V.S.

It is sufficient to mention that the one controlling factor in the efficiency of a Screened Grid Valve lies in its control grid-anode capacity. The lower the capacity the greater the effective amplification available. In the Cossor Screened Grid Valve this inter-electrode capacity has been reduced to the order of  $\cdot 001$  micro-microfarads, a figure which may be better appreciated when expressed as  $\cdot 000,000,001$  mfd. This self-capacity is substantially lower than that of any other battery-operated S.G. valves on the market. Therefore the Cossor S.G. Valve definitely permits a much greater effective amplification to be obtained.

As will be observed from the sectional illustration, the construction of Cossor S.G. Valves is remarkably robust. By the use of an ingenious system of mica bridge pieces, the various elements in the valve are secured in permanent alignment. Even in the event of the valve receiving a blow, not one of the elements could be displaced from its correct relative position. (Contd. on p. 16.)

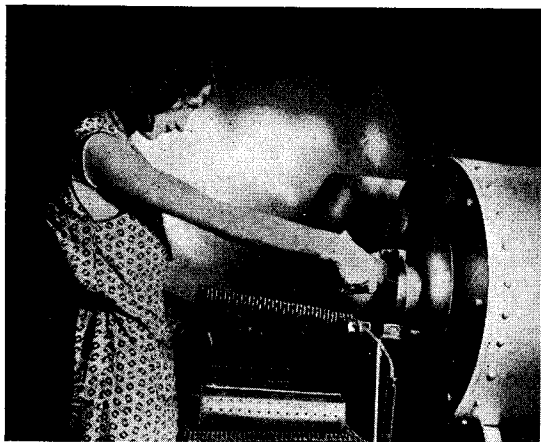

*One of the 20 ft. hydrogen-filled electric furnaces in which metal valve parts are heated to 1000° C. in order to remove all occluded gas and foreign matter.*

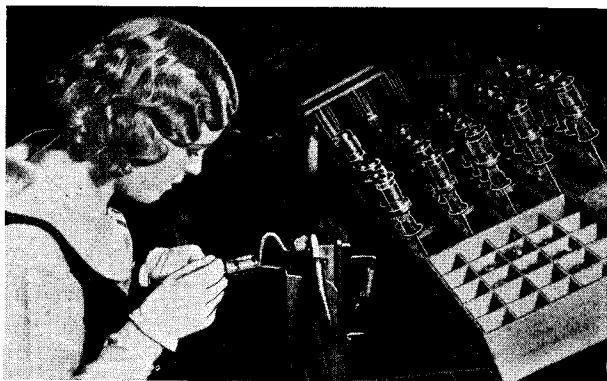

*Spot welding the electrodes. Note the operator's white gloves which prevent moisture from the hands from getting on the valve parts.*

*A view of one of the special Grid Winding machines as described on page 12.*

*A busy corner in which a battery of flange-making machines can be seen.*

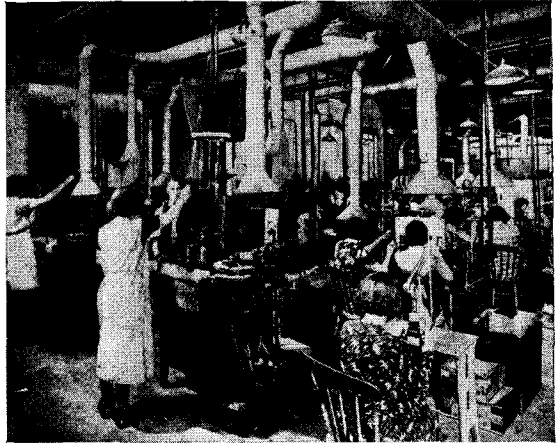

*One of the giant semi-automatic pumping machines on which the valves are exhausted to a high degree of vacuum.*

*Showing some of the rotary ovens in which valve bases are cemented to the glass bulbs.*

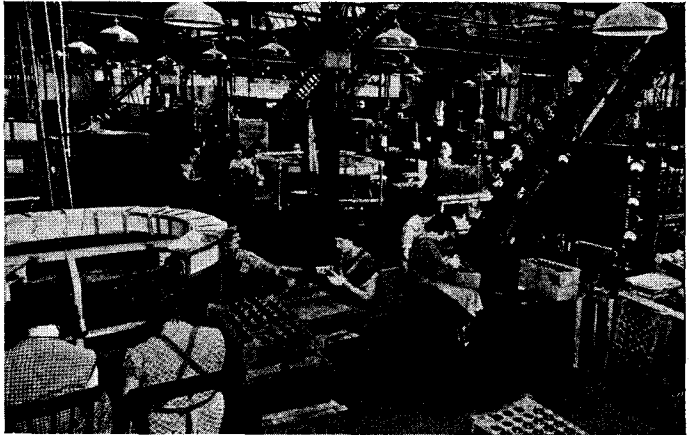



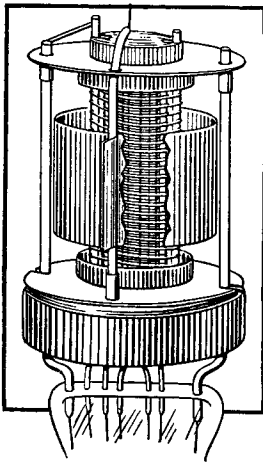

Cossor M.S./Pen.  
Anode cut away to show grids.

This system of Mica Bridge construction, evolved and perfected by Cossor, is utilised throughout the whole range of Cossor Valves. Naturally, with the development of the latest and even more elaborate types of valve, such as, for example, the variable- $\mu$  H.F. Pentode, the utmost accuracy in assembly is essential. The Mica Bridge method is invaluable in making possible very small tolerances.

From a constructional point of view there is very little difference between the three ranges of Cossor

Mains Valves. In the case of the 4-volt series the heater consumes 1 amp. and the valves are usually used for A.C. mains working. The range of Cossor Mains Valves consuming  $\cdot 25$  amp. at 16 volts, may be used for series running on D.C. mains and are valuable for replacements in those receivers that take the standard 16-volt mains valve. The  $\cdot 2$  amp. series includes an indirectly heated rectifier and is therefore eminently suitable for A.C./D.C. sets.

The construction of Cossor Mains Triode Valves follows along the lines which have proved so successful with battery-operated valves. The mica bridge system has been retained in its entirety—and has even been strengthened by the addition of a second mica bridge below the assembly. As will be observed from the illustration, the cathode—which is heated by means of an internal heater wire throughout its whole length—is secured to two mica bridges. Around it is assembled the grid, mounted on two stout supports. And, finally, surrounding the whole assembly is mounted the anode, securely attached to the two mica bridges. The anode itself is of gauze construction, in order that the heat generated within the cathode shall be more readily dissipated.

Obviously, such a construction is immensely strong—even the hardest blow cannot affect its working characteristics or cause any material damage. As has already been seen in the description

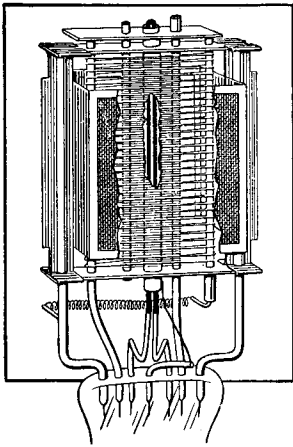

Cossor 41 M.H.L.

of Cossor battery-operated valves, the mica bridge system ensures a very remarkable degree of accuracy in manufacture being attained. And this means, therefore, that Cossor Mains Valves are exceptionally efficient in operation.

Cossor Mains Screened Grid Valves and Mains Pentode Valves are similar in design to battery-operated types, with the exception, of course, that cathodes replace the directly heated filaments.

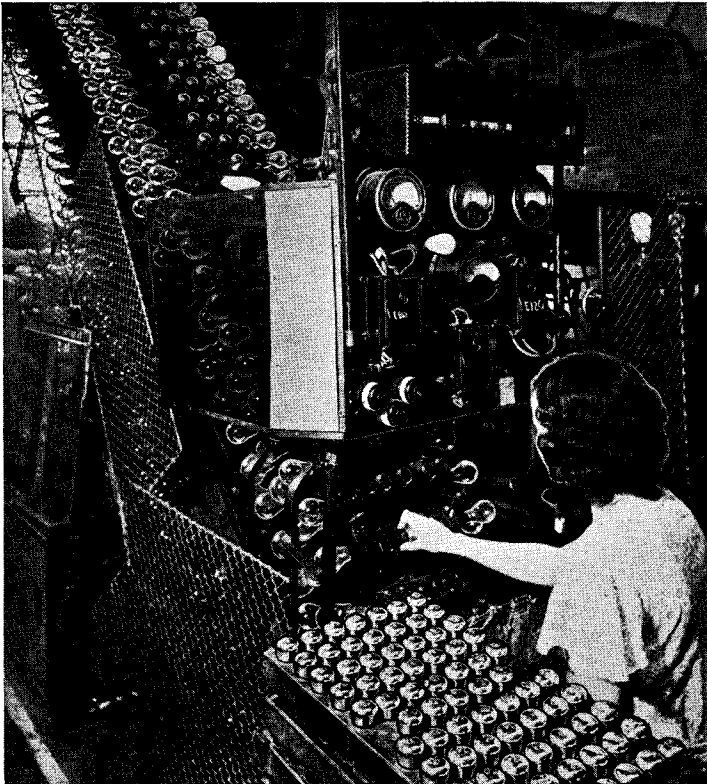

# TYPES OF VALVES AND THEIR USES

## THE DIODE

The first Fleming valve from which all our present-day multi-electrode valves have been developed, was the original detector, and to-day the diode detector has returned to favour. The diode action is briefly as follows :—

Electrons leave the heated filament or cathode, and are attracted to the anode provided this is at a positive potential with respect to the cathode. The space current flows when the anode is positive only ; when negative, no current will flow. Consequently, if A.C. is applied to the anode a space current flows only on the positive half cycle, and hence a current flowing always in the same direction is obtainable.

The more usual form of this valve is as a double diode and current is then obtainable on both halves of the cycle, and we have full wave rectification. Or, as is often the case in practice, one anode is used for half wave rectification while the other is employed for automatic volume control by applying the rectified voltage dependent on the R.F. carrier to the grids of the preceding vari-mu H.F. valves.

## RECTIFIERS

The normal rectifier valve is merely the diode with larger electrodes and a more copious electron stream, made possible by a more generous cathode or filament area for emission. There are both directly and indirectly heated types, single phase and bi-phase, and they are designed to rectify alternating current mains supplies to give high tension energy to receivers.

An important point in rectifier design is the necessity for low voltage drop across the valve. This may be effected by making the anode closely surround the cathode, having regard to mechanical and electrical limitations. When extremely low voltage drop is necessary mercury vapour rectifiers are used, the advantage being that the mercury vapour ionises and tends to neutralise the space charge effect.

## THE TRIODE

Since the introduction of the third electrode into the diode, and the consequent possibility of amplification, various types of triode for specific purposes have been developed. Broadly speaking there are three classifications: the H.F. and detector type with high magnification factor and impedance values of 10–30,000 ohms, the intermediate L.F. amplification triode with impedances of the order of 10,000 ohms, and finally the output triode with low amplification factors and impedances of from 5,000 ohms downwards.

Each of these types has been highly specialised, not only electrically to give the best results when associated with its particular circuit, but also mechanically, the finest points of structure being varied according to type. Microphony in H.F. and detector valves has been prevented by the seven point suspension, involving the threading of the filament through tiny hooks projecting inside the grid turns; the effects of overheating on large output valves has called for much variety and skill in the methods of attacking grid and anode cooling.

## THE TETRODE

The screen grid tetrode valve consists of the standard three electrodes together with a close mesh screen interposed between the signal grid and the anode. This fourth electrode is held at a high positive potential with respect to the cathode, but is usually lower than the anode potential.

The outstanding feature of the tetrode valve is that the screen grid acts as an electrostatic shield between the control grid and anode, and thus prevents uncontrollable feed back from the output to the input circuit. Normal detector triodes for instance, have a grid to anode capacity of 5–10  $\mu\mu\text{F}$ , whereas tetrodes may have this capacity reduced to  $\cdot 001 \mu\mu\text{F}$ . In consequence of this a much greater stable amplification can be obtained from tetrodes.

The anode current-anode voltage characteristic curve of the tetrode valve is of somewhat peculiar shape. Firstly, with increasing anode voltage the anode current rises and then falls, giving the characteristic negative resistance dip of the tetrode, and finally rises again, and thereafter remains practically parallel

to the voltage axis. The cause of the dip in the characteristic is due to the phenomenon of secondary emission from the anode when the latter is at a lower potential than the screen. As the anode potential is progressively raised from zero, there is first an anode current rise owing to the electrons drawn through the screen being all collected by the anode. A further increase in anode voltage causes the primary electrons to strike the anode with sufficient velocity to give rise to secondary electrons which reach the screen, and if more secondaries are leaving the anode than primaries striking it, the net effect will be a fall in plate current accompanied by a rise in screen current. With still increasing anode potential all the available electrons are drawn to the anode and only a very small increase in current will result. Hence an extremely high impedance is obtained when the valve is operated at an anode potential well above the screen, and with a suitable associated anode circuit a very high stage gain may be realised.

### **THE PENTODE**

The five-electrode, or pentode, valve is really the tetrode valve with a coarse mesh grid inserted between anode and screen electrodes. This additional grid is usually internally connected to a low potential electrode, and is termed the earth or suppressor grid. Its main function is to remove the secondary emission dip from the tetrode characteristic. This is accomplished by placing it near the anode, and while being sufficiently open mesh not to impede high velocity primary electrons, it is sufficient to repel low voltage secondary electrons from the anode back to the anode, rather than let them pass through it to the screen.

Two types of pentode have now been developed—the output and more recently the H.F. Pentode. In the case of the output valve, using the correct anode circuit load, it is possible with modern valves to get an exceptionally high anode circuit efficiency, which is a most important consideration for output circuits where dry batteries are to be relied upon for H.T. supply.

With H.F. Pentodes a very high voltage amplification is possible, and the only serious limitation is the attainable associated anode circuit impedance.

## **MULTI-ELECTRODE TYPES**

It has already been pointed out that the triode valve has been developed along specialised lines according to its function in the receiver—that tetrodes and pentodes have been introduced which were really the first multi-electrode valves which fulfilled the duty of more than one triode valve. This process of developing valves, which by virtue of their characteristic, or by dual operation, are the equivalent of more than one simple valve, has been still further extended and embraces double diode triodes, double diode pentodes, Class B amplifiers, and Pentagrids.

The double diode triode consists of the usual three-electrode valve together with two diode anodes mounted round the same cathode sleeve. The diodes may be used for full or half wave rectification or for A.V.C. systems, and the triode is a straight-forward L.F. amplifier feeding the output valve.

The double diode pentode also has the diodes mounted on the cathode in common with the pentode section, and the valve acts as a special vari-mu L.F. Pentode. The valve is intended for corrected A.V.C., gain being varied both in the preceding H.F. stages and on the Pentode itself.

In the case of Class B amplifiers, we have in reality two separate triode valves mounted in the same envelope, and their virtue lies in the fact that they are capable of giving extremely large output for a very low average anode current. In other words, it is an extremely high efficiency output valve which is capable of giving, with ordinary H.T. battery supply, a power output which is usually associated with mains-driven receivers. The Pentagrid is the most recent example of multi-electrode devices designed to simplify Superheterodyne receivers. It fulfils the two functions of providing the local oscillation and frequency conversion. This is accomplished by a triode oscillator section surrounding the cathode, followed by a tetrode assembly. Since all these electrodes affect the same cathode electron stream, frequency conversion is possible by internal mixing of the local oscillator frequency with the radio frequency input to the modulator grid.

# CHARACTERISTICS

## ANODE CURRENT

All radio valves consist essentially of a cathode or filament surrounded by one or more electrodes and sealed in a highly evacuated envelope. When the cathode is heated to a sufficiently high temperature, electrons leave the surface and if a positive potential is applied to the surrounding electrodes a space current will result. In the case of a triode valve, where the anode is held at a high positive potential and the grid at some small negative potential, the space current or anode current is carried by the high velocity electrons which leave the cathode and shoot through the interstices of the grid and reach the anode. The value of this anode current may be altered by the displacement of the electrodes—opening or closing the grid mesh, and externally by variation of anode and grid potentials.

## AMPLIFICATION FACTOR

Shortly after the invention by Dr. Fleming of the Diode Rectifier the introduction of a grid mesh between electron source and anode led to the possibility of obtaining magnification of incoming signals. The maximum magnification of signals which a valve will give is called its amplification factor. This amplification factor or voltage factor of the valve is measured by the ratio of change in anode volts to change in grid volts in order to produce the same change in anode current. In other words, if we denote the amplification factor by “ $M$ ” we have the relationship  $M = \frac{dV_a}{dV_g}$  where  $V_a =$  anode volts and  $V_g =$  grid volts.

The amplification factor of a valve is the product of its mutual conductance and impedance. Hence where large magnification factors are required as in H.F. valves, these constants are made as great as possible, and since mechanical limitations are set on mutual conductance by virtue of the grid to filament clearance, the impedance is made as high as possible. The H.F. screen grids and H.F. pentodes exemplify this, impedances of 500,000 ohms being a not uncommonly high value.

## IMPEDANCE

The anode impedance of a valve is the differential internal resistance of the valve when operated under certain specified conditions.

Usually, for instance, the impedance is quoted for a certain anode potential and fixed bias. It is then measured as the slope of the anode-current anode-voltage curve at the condition specified. Or, stated mathematically, we have  $R = \frac{dV_a}{dI_a}$  where  $V_a =$  anode volts and  $I_a =$  anode current.

It will always be found that in any particular valve the impedance depends primarily on the anode current. As this current is progressively increased the anode impedance will fall. Although however it is desirable on large output triodes to attain an adequately low impedance, this anode impedance cannot be indefinitely lowered owing to the limiting anode dissipation. Hence, for this class of valve, manufacturers indicate the maximum anode volts and optimum bias compatible with these two factors. On the other hand, where high stage gain is necessary, H.F. valves with very great internal resistance values are employed. Triodes with impedances of 20,000—40,000 ohms were extensively used, but with the development of screened valves these figures have been multiplied tenfold; and since there is the same limit to the obtainable slope in both cases, this means an effective valve magnification multiplied also by a factor of ten.

## MUTUAL CONDUCTANCE,

or more colloquially the “slope” of the valve, signifies the rate of change of plate current with respect to a change in grid voltage. The slope is usually denoted by the letter “ $g$ ” and is expressed mathematically as  $\frac{dI_a}{dV_g}$ . From the foregoing it is also obviously equal to  $\frac{M}{R}$  and is sometimes given as such on standard valve curve characteristics.

It is an advantage in many cases to make the mutual conductance of a valve as large as possible consistent with mechanical safety. As an example of this the L.F. side of a receiver may be



considered. Most valves, triode or pentode, until recently required 12 volts or more input to deliver maximum output power. When a diode detector was employed this necessitated an intermediate L.F. amplifier between detector and output. Now, with the introduction of high sensitivity power pentodes with slopes of the order of 7 m.A./v., this intermediate valve is no longer necessary, since the diode detector can easily deliver the three or four volts required for maximum output from these pentodes.

### **CONVERSION CONDUCTANCE**

This is a term often used in conjunction with the pentagrid valve, which performs the dual operation of providing local oscillation and frequency conversion in superheterodyne receivers. Mathematically, conversion conductance is measured as the ratio of the intermediate frequency current in the primary of the I.F. transformer to the applied signal voltage when, in the limit, the I.F. current and the R.F. voltage approach zero. Hence, when considering the performance of frequency changing devices, conversion conductance is the counterpart of mutual conductance considered for single frequency amplifiers.

### **UNDISTORTED OUTPUT**

The power that the output valve can deliver at a given anode voltage and anode current without serious distortion when fully loaded by the penultimate valve, is termed the maximum undistorted power output of the valve. The limiting distortion permissible has been generally agreed to be not greater than 5% total harmonic distortion. Thus manufacturers when giving data concerning output valves, always quote the optimum load impedance for certain stated running conditions to ensure maximum output with second and third harmonic distortion amounting to not more than 5%.

### **GRID BIAS**

On all valve specifications best working conditions are given which include a stated value of bias. This determines the "working point" of the valve and departure from it may lead to serious distortion or even ruin the valve characteristics.

There are two general methods of applying bias : (a) by the use

of a separate grid bias battery, and (b) self bias obtained across a resistance placed in the cathode circuit of the valve.

In the first case, the positive of the bias battery is taken to one side of the filament and the correct negative point applied to the grid—usually through some form of resistance. Since the positive grid bias and negative H.T. are common, the grid bias need not necessarily be a separate battery. Hence close tappings are often provided on H.T. batteries in order to provide for grid bias. The automatic or self bias method makes use of the voltage drop set up across a resistance by the electron current of the valve. This resistance is usually placed between the cathode of the valve and earth and causes the cathode to be positively biased with respect to ground. Since the grid circuit returns to ground, this is equivalent to a negative bias on the grid itself.

In calculating the value of resistance required, it is essential to consider total cathode current that is passed under the required operating conditions. For instance, in tetrodes and pentodes the screen current must be added to the plate current, and this number of milliamps when divided into the required bias voltage will give the necessary biasing resistance in thousands of ohms.

It must not be forgotten, that this convenient method of obtaining self bias automatically reduces the voltage on the anode with respect to cathode by the same number of volts of bias that are being applied, and allowance must be made for this. In the case of vari- $\mu$  H.F. valves, a variable grid voltage may be used to control stage gain. This is usually effected by means of a variable resistance in the cathode circuit supplemented by a series fixed resistance to ensure that a minimum bias is always maintained.

---

# APPLICATIONS

See also useful circuits section—Page 127, etc.

## THE H.F. STAGE

With the introduction of the H.F. Pentode the choice of an indirectly heated screened grid valve becomes somewhat complicated, there now being four main classes of H.F. amplifiers: (a) ordinary screened grid valves, (b) variable-mu valves, (c) ordinary H.F. pentodes, and (d) variable-mu H.F. pentodes.

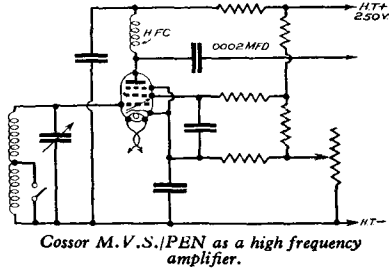

There is little to be said about the ordinary screened grid valve except to emphasize the point that the valve such as M.S.G./L.A. is capable of very high gain when used with suitable coupling; consequently screening and layout become far more important than when battery valves are being used.

As far as the valves themselves are concerned, those of Cossor manufacture are inherently stable owing to the abnormally low anode/control-grid capacity, but naturally good design in the valve cannot overcome bad set design.

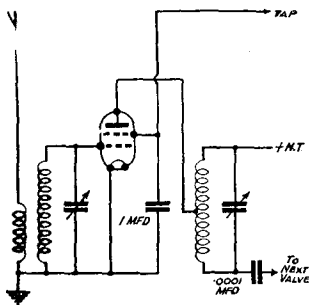

Tapped Tuned Anode.

Considering the four groups separately, attention may be first turned to the variable-mu. The variable-mu valve differs from the ordinary screened grid only in the formation of its grid, resulting in smooth control of gain when grid bias is increased. Thus when an entirely satisfactory form of volume control is

required it should be obtained in the H.F. stage by using the variable-mu valve and its associated volume control.

The H.F. pentodes are available with and without variable-mu characteristics, and the type to be used should be selected purely in accordance with the function it has to fulfil.

Generally speaking, an H.F. pentode will give equal or better results than a screened grid valve, presuming that the coupling employed is equally suitable. The variable-mu variety enjoys the same advantages as the variable-mu screened grid valve, and has the added advantage that the available output is considerably larger.

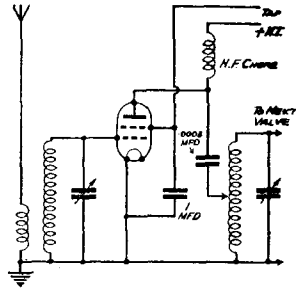

*Tapped Tuned Grid.*

The full advantage of an H.F. pentode is gained when the anode load is exceptionally high. Consequently this valve is particularly suitable for the intermediate stages of a super-heterodyne, where considerable scope for design is offered.

The non-variable-mu screened grid pentode can of course be used in any position where an ordinary screened grid valve could be used, but its chief advantage is in the sphere of a leaky grid detector, where high sensitivity is obtainable.

The Cossor high frequency pentodes are available with seven-pin bases, permitting the metallised coating and the suppressor grid to be brought out to separate pins.

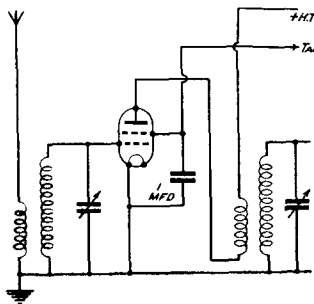

*Tuned Transformer Coupling with S.G. Valve.*

This makes various modifications possible, as any potential may be applied to the suppressor grid. For example, a variable negative potential up to 30 volts will give combined decrease in volume and selectivity, which is extremely useful when it is desired to obtain the very best quality from local stations.

## DETECTION

Triode valves (over 9,000 ohms impedance) will usually be used in the detector stage where almost any triode valve can be used providing circuit conditions are suitable.

As an illustration of the point, the 210 R.C., having an impedance of 50,000 ohms, may be the best possible detector with a particular coupling; on the other hand, the 220 P.A., when followed by any very low impedance coupling, is the valve to use as a power grid detector following two efficient stages of screen grid amplification.

## TRIODE LEAKY GRID DETECTOR

This arrangement is universally known, and generally speaking the Cossor 210 H.F. or H.L. will be found the most satisfactory valves to use, but no hard or fast rules can be laid down, as it is dependent on the particular transformer used and the volume of the signal to be handled.

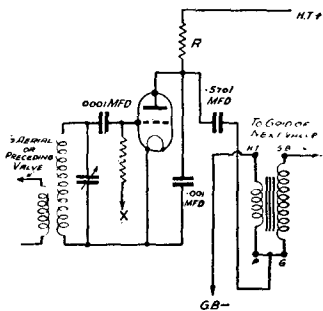

Fig. 1. Resistance Fed Transformer.

## TRIODE POWER GRID DETECTION

For this arrangement the resistance fed transformer circuit at Fig. 1 is recommended, only the grid leak, instead of being 2 megohms, can conveniently be .24 to .5 megohms, and the H.T. at anode somewhat higher.

Cossor H.F. Pentodes are extremely brilliant detectors and may be used most conveniently as leaky grid detectors when transformer coupled, which results in a very large gain in the detector stage, or may be used as anode bend detectors followed by resistance coupling, where the gain will be slightly larger than a triode valve used with transformer coupling.

This method is, however, to be avoided when smooth reaction is required, as it is almost impossible of attainment when using such a valve working at anode bend. Perfectly smooth reaction is, of course, obtainable when using this valve as a leaky grid detector.

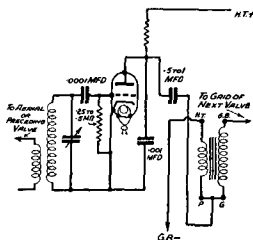

Power Grid Detector.

## OUTPUT TRIODE

The choice of an output valve should be governed by consideration of the exact purpose that it has to fulfil. The duty of an output valve is to accept an A.C. voltage already amplified by the preceding stage or stages, and to act not merely as a voltage amplifier but to supply audio energy to actuate the loudspeaker. No serious distortion must, of course, be introduced.

Distortion in the output stage is caused either by the supply of too large a signal to its grid, or by the use of an incorrect output arrangement whereby the valve is made to work into an impedance that is too widely divergent from its optimum load. While the figure quoted as the optimum load of the valve under any given conditions need not be taken as hard and fast, if the figure is widely divergent very considerable increase in distortion results, far more, in fact, than is generally appreciated.

When exceptional volume is required, two valves may be used in push-pull when greater care than ever should be taken to select suitable output valves, the optimum load of two valves in push-pull being usually twice that of one valve used alone.

From an economic standpoint there is rarely any excuse to use any but the largest valve in a particular class in a push-pull arrangement. In other words, the use of two Cossor 220 P. valves in push-pull would be rather pointless when a somewhat larger output can be more easily obtained by using a single 230 X.P.

## OUTPUT PENTODE

The Pentode valve is usually looked upon as a valve to be used where additional sensitivity is required, but for A.C. working this is perhaps the wrong viewpoint, as sensitivity is usually to be gained elsewhere. It therefore results in a consideration of convenience when a choice has to be made between a triode and a pentode output valve.

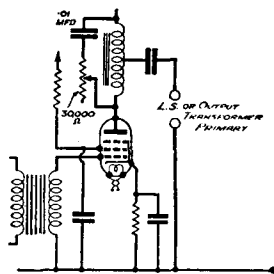

*Auto Transformer Output Filter with Tone Control for indirectly heated pentode.*

The advantages of a pentode as a means of reproducing music with excellent quality are not fully realised, due to the scant attention that is often given to the requirements of such a valve. Owing to inherent characteristics the choice of a loud speaker or the modification of one by a choke output filter is far more critical than with a triode valve. Further, the primaries of many loud speaker transformers have a totally inadequate

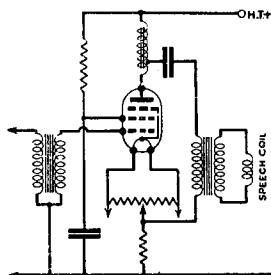

Method of correcting impedance of Moving Coil Speaker for use with Pentodes. The circuit shown is for a directly heated pentode running on A.C. Mains.

as they are dependent rather on the loud speaker used than upon the valve, but .01 mfd. and 10,000 ohms in series across the primary of the speaker transformer will be found reasonably satisfactory in the majority of cases.

There is usually nothing to be gained by using pentodes in push-pull, and this technique is usually avoided except by those who are familiar with it and are willing to devote a reasonable amount of time to experiments. In this direction considerable difficulties are often encountered in producing a loud speaker transformer of sufficiently high ratio without introducing an uneven frequency response.

inductance at the lower frequencies even though the figure may be correct at mean speech frequency, at which figure the impedance of an output transformer is usually quoted.

When using an economy pentode, as Cossor 220 H.P.T., with almost any type of speaker, it is necessary to use tone correction, the exact values of which cannot be prescribed

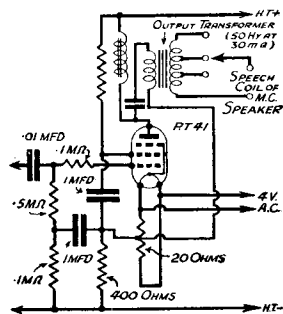

Fully decoupled Output Stage for directly heated pentode.

## OUTPUT—CLASS “B”

There are two Cossor Class “B” Valves. The Cossor 240 B. is the larger, and this valve is capable of giving over twelve times the undistorted output available from a standard power valve. Further, in so doing, the average current taken from the high tension battery is actually less.

The Cossor 220 B. is a little smaller, and for this reason has found widespread favour for ordinary domestic Receivers. It is capable of giving all the volume that can be required for normal home purposes even when a large Moving Coil Loud-speaker is used. Its current consumption is less than the Cossor 240 B. and, of course, less than that required by a standard power valve.

Some idea of the power available from the Cossor 220 B. can be gained by comparing it with a large battery Pentode which would take several times as much high tension current and yet be still incapable of delivering the same volume of undistorted output.

An interesting comparison (Fig. 1) shows diagrammatically the current drained from the H.T. battery by various types of output valve *when the volume available is exactly the same in each case.* The reason for this remarkable economy will be more readily understood if the working of the valve is compared with that of the ordinary output system. The standard output valve draws a definite current from the H.T. battery quite irrespective of the work that it is doing at any particular moment. For example, the H.T. consumption will remain the same during a programme interval as when the output valve is called upon to deliver the full volume of a heavy orchestral

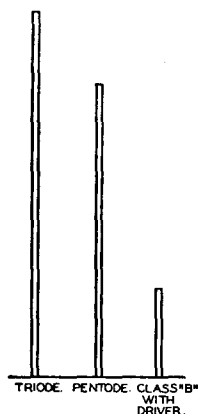
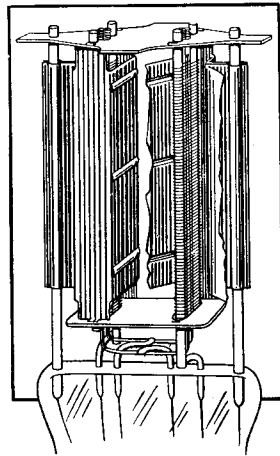

Fig. 1.—Diagram shows current taken by three types of output stages when delivering the same volume.



item. In other words, the current drawn by a normal output stage is regulated by its sufficiency to deal with the loudest passage of music that will be experienced. On the other hand, the average sound level will probably not exceed one-fifth of such volume.

With a Cossor Class "B" valve this waste of high tension current is eliminated because when the set is idle, i.e. during a programme pause, the total current consumption drops to two or three milliamps. When the incoming signal arrives each half cycle causes the anode current to rise in proportion to the magnitude of the signal to be handled. In other words, the high tension current drawn is the minimum at any instant for the work to be done and there is no waste.



**Cossor 220B**

*One anode cut away to show internal construction.*

### General Remarks

It is customary to connect two condensers across the output circuit of a Class "B" Valve as shown at Fig. 2, and reference to the circuit on page 134 will show that it is so equipped. They should be considered an integral part of the output stage and should never be omitted.

### Tone Control

A condenser having a capacity of  $\cdot 01$  mfd. is normally connected across the secondary of the Driver Transformer. If a deeper tone is required this may be increased

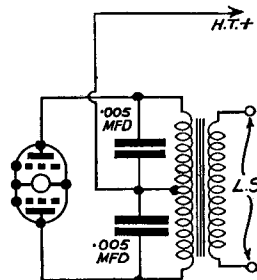

*Fig. 2.—Condensers connected across output circuits.*

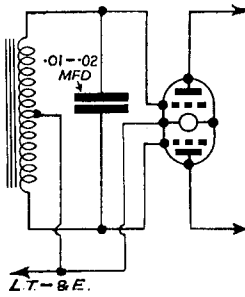

Fig. 3.—It is usual to shunt the driver transformer with a condenser.

heterodyne to cause excess waste of anode current in the Class "B" Valve. A form of variable control is shown in Fig. 4.

### The Driver Transformer

The Driver Transformer is used to couple the Driver Valve to the Class "B" output valve, and obviously it is important that it is of suitable design. The secondary winding must possess low resistance—not more than 300 ohms (total for both halves) for the Cossor 240 B. A slightly higher value is permissible for the Cossor 220 B. The majority of Driver Transformers available on the market have an overall ratio of 1 : 1. These are suitable as far as the ratio is concerned for coupling the Driver Valve to either the Cossor 240 B. or the Cossor 220 B., when the former is a small Power Valve (either Cossor 215 P., 220 P. or 220 P.A.).

### The Output Circuit

In order that it may deliver its maximum undistorted output, any output valve must work into its optimum load. That is to say, the impedance in the anode circuit must be neither too high nor too low.

A Triode output valve of low efficiency is the most tolerant to incorrect loads, but the distortion of Class "B," QPP, and Pentode Valves rises fairly quickly as the optimum load is diverged from. In addition to having the correct

as desired (see Fig. 3). This condenser should never be omitted, unless some other top note limiting device is used, as its absence would allow aninaudible

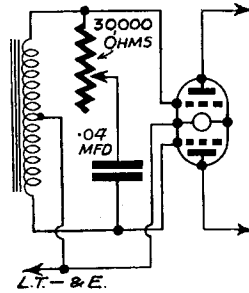

Fig. 4.—Variable tone control in front of Class "B" valve.

impedance, the output choke or transformer must be of low resistance, say, not more than 200 ohms each half.

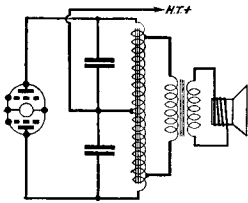

Fig. 6.—Using a speaker without tap and corrected by tapped output choke.

The Table below (Fig. 5) shows at a glance what ratio of output choke will be required to adapt a standard loud speaker for correct working with Cossor Class "B" amplification under various conditions. Fig. 6 shows the correct method of connection.

Speaker Primary Impedance	Ratio of Output Choke (to 1)			
	240 B (H.T. 120)	240 B (H.T. 90)	220 B (H.T. 120)	220 B (H.T. 90)
3,000 ohms	1.6	1.8	2.0	2.6
4,000	1.4	1.6	1.75	2.25
5,000 "	1.3	1.4	1.5	2.0
6,000 "	1.2	1.3	1.4	1.8
7,000 "	1.1	1.2	1.3	1.7
8,000 "	1.0	1.1	1.2	1.6
9,000 "	—	1.0	1.1	1.5
10,000 "	—	1.0	1.1	1.4
11,000 "	—	—	1.0	1.3
12,000 "	—	—	—	1.3
13,000 "	—	—	—	1.25
14,000 "	—	—	—	1.1
15,000 "	—	—	—	1.1

Fig. 5.—This table shows the correct ratio of output choke for use with loud speakers already equipped with transformer; a choke will naturally require a centre tap from H.T. and must be suitable for Class "B" working.

## AUTOMATIC VOLUME CONTROL.

Owing to the large variation in signal strength of the stations which can be received on a sensitive set, the operation of the volume control becomes very critical, and the set is often operated in an overloaded condition, while tuning through a powerful station produces aural discomfort. Moreover, the reception of distant stations is so marred by fading that their programme value becomes negligible. The incorporation of automatic volume control ensures that all stations above a certain minimum strength are received at approximately the same volume, so that the correct operation of the set becomes a simple matter even for a novice, while fading is also eliminated.

Automatic Volume Control is a system whereby the high frequency gain of a receiver is regulated according to the field strength of the signal received ; a small change in the output of the H.F. amplifier is arranged to alter the bias on the preceding valves, and thus cause a considerable reduction in the sensitivity of the receiver. A change in voltage at the aerial of say 10,000 to 1 can be so compensated for in this manner that the input to the detector changes by only one to two decibels—an almost inaudible change.

It will be seen that the control voltage is derived from the high frequency component of the received signal, and is therefore independent of the depth of the modulation.

The simplest method of incorporating A.V.C. uses a double diode, as shown in the diagram :—

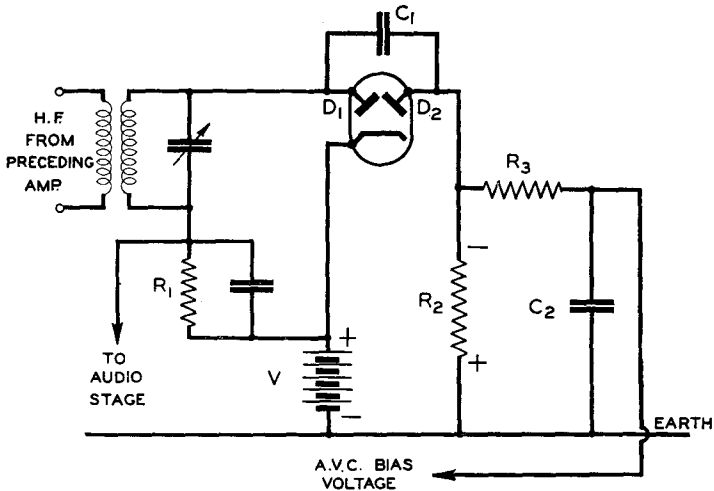

The diode  $D_1$  rectifies the incoming signal, and the audio frequency voltage developed across its load resistance  $R_1$  is passed on to the succeeding audio frequency amplifier. The incoming signal is also applied to the A.V.C. diode  $D_2$  through the condenser  $C_1$ . This diode is biased negatively with respect to its cathode by the voltage  $V$ . When the H.F. voltage exceeds the voltage  $V$ , the diode anode will swing positive and current will flow through the resistance. The voltage thus appearing across  $R_2$  is then fed back to the preceding valves, which should have vari-mu characteristics.



# THE SUPERHETERODYNE

The essential feature of the superhet principle is the conversion of all incoming frequencies to one fixed frequency, which may be higher or lower than the frequency being received, thus high selectivity may be obtained without an unwieldy number of variable tuned circuits. Usually a lower frequency is chosen because (a) by converting the signal to a lower frequency the percentage separation is increased (e.g. the separation between two stations 10 kc./sec. apart on 300 metres is 1% ; if the frequency is converted to 3,000 metres the separation between the same two stations now becomes 10%). (b) The efficiency of the tuned circuits increases at the lower frequencies, and (c) a higher amplification percentage is easily obtainable since capacitative feedback is reduced.

For reception over the 200—2,000 metre band frequencies around 120 kc./sec. or 450 kc./sec. are usually chosen. If the frequency is reduced still further, undesired responses due to second channel interference are difficult to eliminate without excessive pre-selection. The process of frequency changing is carried out in the following manner.

A local oscillation is produced whose frequency differs from that of the wanted signal by the amount chosen for the intermediate frequency amplification. The wanted signal and the local oscillation are now applied to a non-linear device resulting in the production of sum and difference frequencies, one of which is picked out for subsequent amplification. The non-linear device used for mixing consists of two main types. (1) The two frequencies are applied to a thermionic valve which is working on a non-linear part of its characteristic, e.g. to the grid of a screen grid valve so biased that its grid-volts anode-current characteristic obeys a square law over the required working range. (2) The two frequencies are applied to two separate grids of a thermionic valve which is so designed that the mutual conductance of the signal grid is varied by the variation of voltage on the grid to which the local oscillation is applied. Thus the coupling between the two circuits is purely electronic.

It is into the latter class that the Pentagrid falls. This valve has been specially designed as a frequency changer for the superhet. Its chief advantages are : negligible radiation from the aerial of the locally generated oscillation ; the elimination of direct coupling between the signal and oscillator circuits

prevents interaction between them and simplifies the circuit connections; the reduction of undesired responses due to oscillator harmonics and to a non-linear signal grid characteristic; the ability to use the valve for A.V.C., also the considerable latitude allowable in the amplitude of the oscillator voltage, and the elimination of the need for a separate valve to generate that voltage. This latter is simply done in the case of the electronically coupled frequency changer by building into the valve another grid which acts as an anode to the oscillator grid, but is so placed that its effect on the main electron stream is negligible.

The operation of the pentagrid may be visualised in the following way. When the first grid swings negative the mutual conductance of the fourth grid is reduced, and as grid one becomes more positive the mutual conductance increases linearly. Thus the amplification of the signal applied to the fourth grid is alternately increased and decreased at the frequency of the local oscillation voltage on grid one. This results in the production of sum and difference frequencies in the anode circuit. The tuned circuit in the anode behaves as a high impedance to the I.F. frequency and a low impedance to all other frequencies, and thus the desired frequency is selected. Grids three and five, which have not yet been mentioned, serve to accelerate the electron stream and to provide electrostatic screening. They are connected together internally. Grid three screens the oscillator section from the modulator section and grid five

screens the signal grid four from the anode, and by increasing the anode impedance reduces the damping on the anode tuned circuit to a negligible quantity.

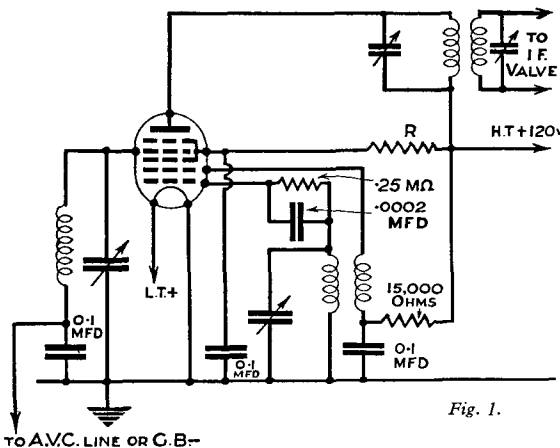

Fig. 1.

Figs. 1 and 2 show the normal and recommended circuit con-

nections for the battery and mains versions of the pentagrid. The recommended oscillator voltage on grid one is approximately 8 v. R.M.S. on the 41 M.P.G., 5 v. on the 210 P.G., and 7 v. on the 13 P.G.A. This voltage, however, is not critical and a variation of plus or minus 25% has no effect on the operation of the valve whatsoever. The conversion conductance, which is the ratio between the intermediate frequency current in the anode circuit and the H.F. voltage applied to the signal grid, is a measure of the efficiency of a frequency changer, in the same way as the mutual conductance is a measure of the efficiency of a valve used as an amplifier. The conversion conductance of the pentagrid is high and compares favourably with that obtained by any other method. Its value is as follows :—41 M.P.G., 1.25 m.A./volt ; 13 P.G.A., 0.75 m.A./volt ; 210 P.G., 0.45 m.A./volt.

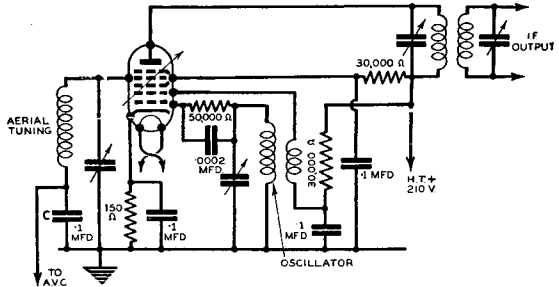

Fig. 2.

The Stage gain can be calculated from the formula :

$$\frac{g_c \times R}{1,000}$$

where  $g_c$  = conversion conductance in m.A. per volt.

$R$  = dynamic impedance of the anode circuit in ohms.

For example, the 41 M.P.G. gives a gain of 200 times with an anode dynamic load impedance of 140,000 ohms ; a figure easily attainable with an ordinary I.F. tuned circuit. With the recommended circuit, undesired responses due to oscillator harmonics beating with unwanted stations are negligible, while those due to curvature of the signal grid characteristics are also inconspicuous since the principle of operation of the pentagrid allows the valve to be worked under linear conditions.

Considerable care in the design of the pentagrid has been taken in order to get the highest possible conversion conductance for a given anode current, in order to obtain an exceedingly favourable signal to noise ratio.



## USEFUL VALVE FORMULAE

**A.C. Resistance (impedance).**  $R_0 = \frac{\text{change in anode volts}}{\text{change in anode current}}$   
 (Grid volts constant). Unit: Ohms.

**Mutual Conductance or Slope.**  $g = \frac{\text{change in anode current}}{\text{change in grid volts}}$   
 (Anode volts constant). Unit: Milliamps.  
 (anode current) per volt (on grid).

**Amplification Factor.**  $\mu = \frac{\text{change in anode volts}}{\text{change in grid volts}}$   
 (Anode current constant). Unit: None,  $\mu$  is a pure number.

These three are related :

$$g = \frac{\mu}{R_0}, \mu = gR_0, \text{ or } R_0 = \frac{\mu}{g}$$

For these to hold,  $g$  must be in amps. per volt.

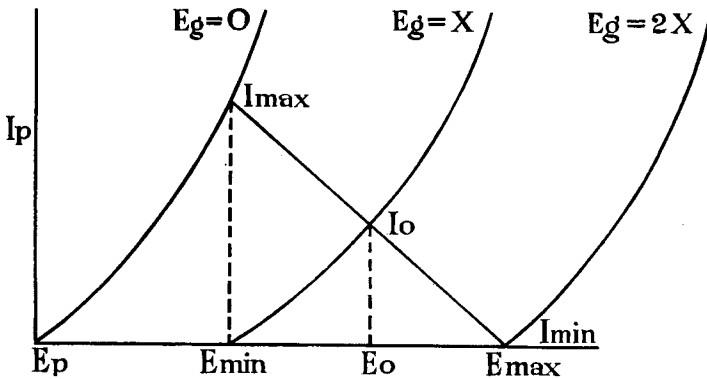

**Output Watts (A.C.).** (See Fig. above).

Five per cent. second harmonic distortion is obtained when the distance  $I_{\max} - I_0$  is  $\frac{1}{9}$  of the distance  $I_0 - I_{\min}$ ,  $I_0$  being the operating point.

A number of load lines fulfilling these conditions can be found by trial and error, of these lines the optimum-load is that which gives the greatest output as calculated by the formula below.

The slope of the load line indicates the external load, i.e., in the latter is termed  $R$

$$R = \frac{E_{\max.} - E_{\min.}}{I_{\max.} - I_{\min.}} \text{ (ohms)}$$

$E$  in volts,  $I$  in amps.

### Percentage of Second Harmonic Distortion.

$$= \frac{\frac{I_{\max.} + I_{\min.}}{2} - I_0}{I_{\max.} - I_{\min.}} = \frac{\frac{E_{\max.} + E_{\min.}}{2} - E_0}{E_{\max.} - E_{\min.}}$$

### Output Watts.

$$= \frac{1}{8}(I_{\max.} - I_{\min.})(E_{\max.} - E_{\min.})$$

### Output Watts (Brain's Formula).

$$W = .041\mu k \left(\frac{Ea}{\mu}\right)^{\frac{5}{2}} \text{ approx.}$$

Where  $Ea$  = Anode Voltage  
 $\mu$  = Amplification Factor

$$k = \frac{Ia}{\left(\frac{Ea}{\mu} - Eg\right)^{\frac{3}{2}}}$$

Where  $Eg$  = Grid Voltage  
 $Ia$  = Anode Current

### Optimum Load ( $R$ ).

$$R = 1.9\frac{\mu}{k} \left(\frac{Ea}{\mu}\right)^{-\frac{1}{2}} \text{ ohms}$$

### Voltage Amplification (Stage Gain).

$$A = \frac{\mu Z}{Z + R_0}$$

Where  $Z$  is the impedance between anode and earth (H.T.+).  $Z$  may be a pure resistance (resistance coupling), a dynamic resistance (tuned anode coupling) or an inductance or capacity. In the latter cases,  $Z$  and  $R_0$  must be added vectorially. For transformers, the ratio must be taken into consideration.

# COSSOR VALVES AND THEIR CONNECTIONS

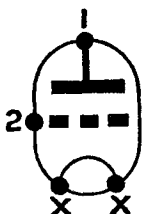

*Directly heated Triode*

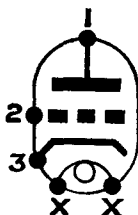

*Indirectly heated Triode*

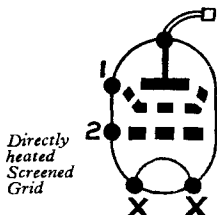

*Directly heated Screened Grid*

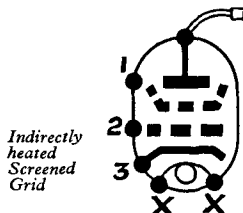

*Indirectly heated Screened Grid*

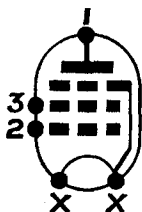

*Directly heated Pentode, 5-pin type*

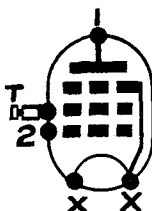

*Directly heated Pentode 4-pin type*

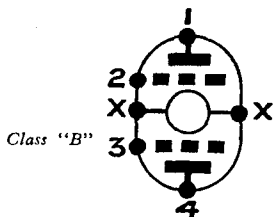

*Class "B"*

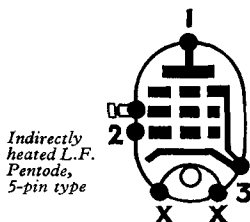

*Indirectly heated L.F. Pentode, 5-pin type*

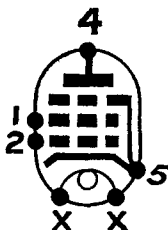

*Indirectly heated L.F. Pentode, 7-pin type*

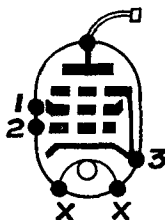

*Indirectly heated H.F. Pentode 5-pin type*

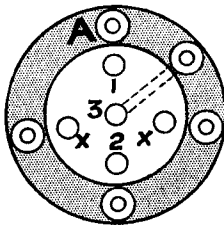
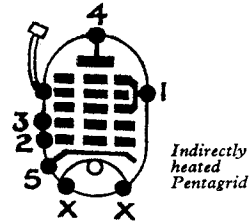
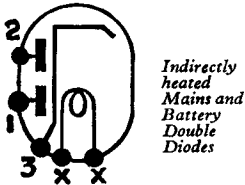
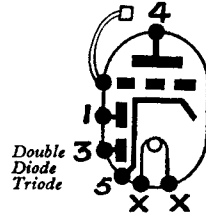
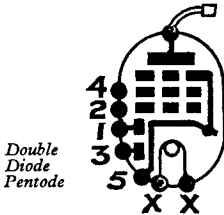
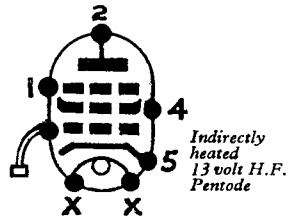
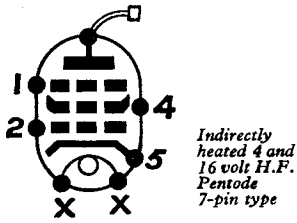

5-pin Valve Holder. This arrangement holds good for 4-pin valves, the centre socket being omitted.

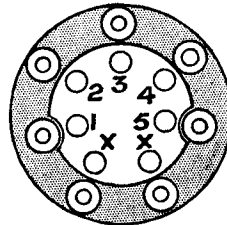

7-pin Valve Holder. This is the standard B.R.V.M.A. arrangement for Valves with 7 pins.

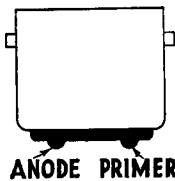

Neon Tuning Indicator. Type 3180 Base The Cathode is connected to cap.

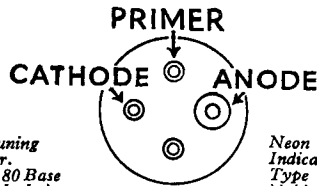

Neon Tuning Indicator. Type 3184 Holder

# COSSOR 210 V.P.T.

## 2-VOLT VARIABLE MU H.F. PENTODE

The Cossor 210 V.P.T. is a variable- $\mu$  screened grid H.F. pentode, and represents the latest advance in the design of H.F. amplifier valves.

It differs from the ordinary screened grid valve inasmuch as there is an extra grid interposed between screening grid and anode, which so modifies the characteristics of the valve that it can deliver a larger output, without risk of rectification, than that available from the ordinary variable- $\mu$  screened grid.

The valve is suited for use as an H.F. amplifier or as an I.F. amplifier in battery superheterodyne receivers. Its variable- $\mu$  characteristic allows automatic volume control to be applied.

### TECHNICAL DATA

Filament Voltage .. .. .	2
Filament Current (Amps.) .. .. .	1
Mutual Conductance .. .. .	1.1 m.a./v.
Maximum Anode Voltage .. .. .	150
Maximum Auxiliary Grid Voltage .. .. .	80
Grid Bias Voltage (Variable) .. .. .	0 to -9
Anode Current for 150 Anode Volts and 0 grid bias	2.9 m.a.
Anode Current for 150 Anode Volts with -1.5 volts grid bias	1.5 m.a.

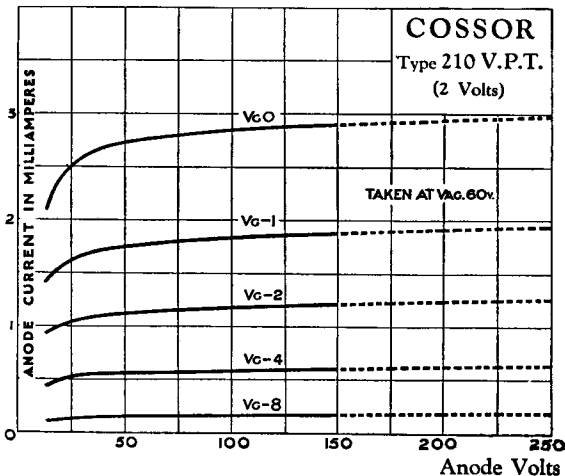

# COSSOR 220 V.S.

## 2-VOLT VARIABLE MU. S.G.

This valve is a screened grid tetrode of the variable-mu type and has a relatively short grid base. For this reason it requires only a 9-volt grid bias battery to give adequate control of stage gain. By virtue of its characteristics this valve has a low high-tension consumption, and is capable of very high stage gain when associated with suitable coils. Like other Cossor screened grid valves, it has a very low grid-anode capacity of the order of .001 micro-microfarads.

### TECHNICAL DATA

For Super H.F. Amplification.

Filament Voltage .. .. .	2
Filament Current (Amps.) .. .	.2
Impedance (Ohms) .. 400,000	} at { $V_a$ . 150 $V_{sg}$ . 60 $V_g$ . 0
Mutual Conductance 1.6 m.a./v. }	
Maximum Anode Voltage .. .. .	
Grid Bias Variable .. .. .	0 to -9 v.
Anode Current for 150 Anode Volts with -1.5 volts Grid Bias (Average) ..	1.6 m.a.
Normal Working Anode Voltage .. ..	120
Positive Voltage on Screen Grid .. ..	60-80

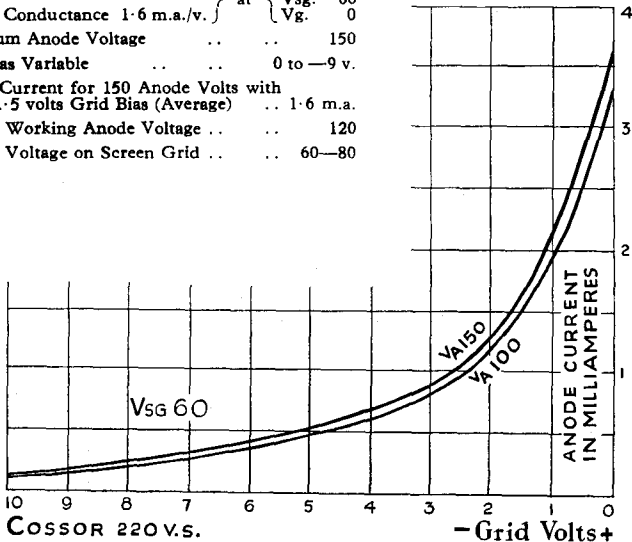

# COSSOR 220 V.S.G.

## 2-VOLT VARIABLE MU S.G.

This is a variable-mu screened grid valve, and was the first of its type to be introduced by Cossor. It differs from the 220 V.S. in that its grid base is considerably longer. Where an 18 volt grid battery can be fitted to a set, variable bias on the grid of this valve gives a very efficient and gradual form of manual volume control.

In a multi-stage receiver, the form of its variable-mu characteristic is such as to reduce cross modulation very considerably owing to the lack of any abrupt changes in its slope.

The inter-electrode capacity is the same as that of the 215 S.G. and 220 S.G., viz. .001 micro-microfarads. A very high stage gain is obtained which will, of course, be decreased as bias is increased, thus providing the set with a perfect volume control capable of enormous variation.

### TECHNICAL DATA

For Super H.F. Amplification.

Filament Voltage	2
Filament Current (Amps.)	2
Impedance (ohms)	110,000
Mutual Conductance	1.6 m.a./v. at
Maximum Anode Voltage	150
Grid Bias Variable (for 1 stage)	0—9 v.
Grid Bias Variable (for 2 stages)	0—15 v.
Anode Current (Va. = 150 and Grid Bias (average)	—1.5 volt
Normal Working Anode Voltage	120
Positive Voltage on Screen Grid	60-80

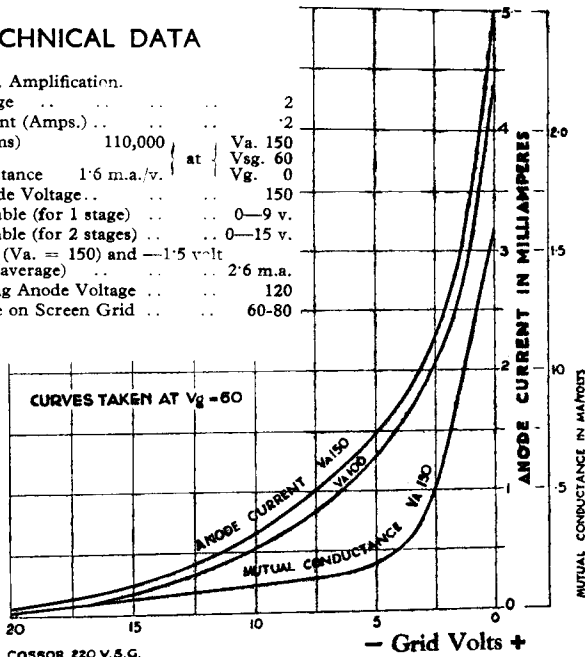

COSSOR 220 V.S.G.

# COSSOR 210 S.P.T.

## 2-VOLT H.F. PENTODE

This high frequency pentode has a normal anode-current grid-voltage curve without the so called variable-mu characteristic. In consequence, when used as an H.F. amplifier, it should be used only in the first position in the set where the signal voltage is small.

The Cossor 210 S.P.T. is an extremely brilliant detector valve, and may be used as a leaky grid detector when transformer coupled, which will result in a very large gain in the detector stage, or it may be used as anode bend detector followed by resistance coupling, where the gain will be slightly larger than a triode valve used with transformer coupling.

This method is, however, to be avoided when smooth reaction is required, as it is almost impossible of attainment when using such a valve working at anode bend. Perfectly smooth reaction is, of course, obtainable when using this valve as a leaky grid detector.

### TECHNICAL DATA

Filament Voltage	.. . . . .	2
Filament Current (Amps.)	.. . . . .	.1
Mutual Conductance	.. . . . .	1.3 m.a./v.
Maximum Anode Voltage	.. . . . .	150
Maximum Auxiliary Grid Voltage	.. . . . .	80
Anode Current for 150 Anode Volts, 0 grid bias	.. . . . .	3 m.a.
Anode Current for 150 Anode Volts and -1.5 volts grid bias	.. . . . .	2 m.a.

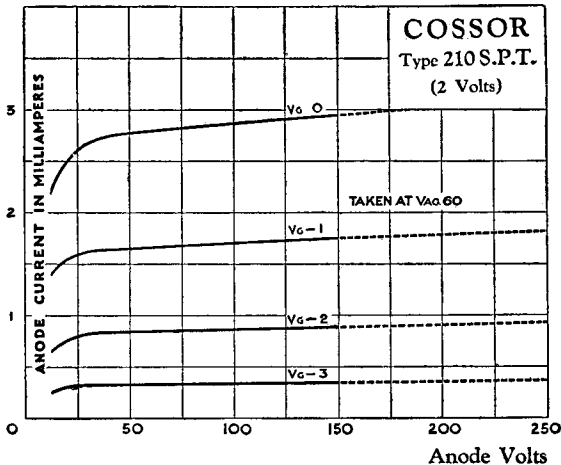



# COSSOR 215 S.G.

## 2-VOLT SCREENED GRID

This valve is a screened grid tetrode valve and was manufactured before the introduction of variable- $\mu$  valves. It has been used in enormous numbers of portable and other battery receivers with conspicuous success. It develops its maximum efficiency when followed by a coupling of high dynamic resistance which possesses no step up.

Special attention is drawn to the unique grid current characteristic. No current flows in the grid circuit with zero applied voltage. This valve may therefore be used without grid bias and the full rated mutual conductance is realised in practice. In spite of the exceptional stage gain thus developed, the valve is inherently stable owing to the very low inter-electrode capacity of the order of  $\cdot 001$  micro-microfarads.

### TECHNICAL DATA

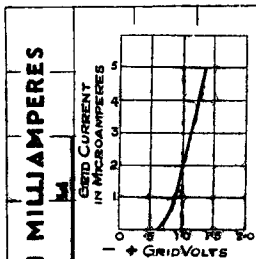

For Super H.F. Amplification.

Filament Voltage	2
Filament Current (Amps.)	$\cdot 15$
Impedance (ohms)	300,000
Amplification Factor	330
Mutual Conductance	$1\cdot 1$ m.a./v.
Maximum Anode Voltage	150
Grid Bias for economy of H.T. current	$-1\cdot 5$ v.
Anode Current for 150 Anode Volts with $-1\cdot 5$ volt Grid Bias (Average)	$\cdot 7$ m.a.
Normal Working Anode Voltage	120
Positive Voltage on Screen Grid	60-80 v.

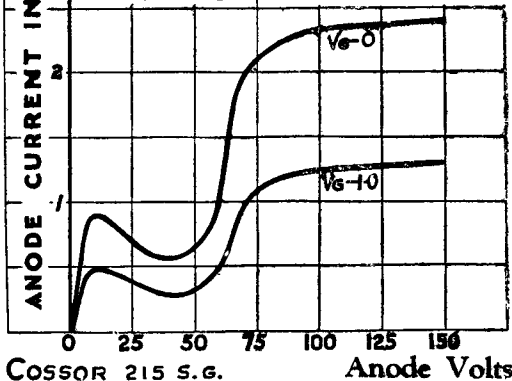

# COSSOR 220 S.G.

## 2-VOLT SCREENED GRID

The 220 S.G. is a very similar valve to the 215 S.G. but has a somewhat lower impedance and a higher mutual conductance. When used in conjunction with ordinary commercial coils, screened grid valves develop a gain which is proportional, in almost all cases, to the mutual conductance. Hence this valve is used in preference to the 215 S.G. where enhanced sensitivity is required. The same limitation applies to this valve and the 215 S.G. as to the 210 S.P.T. in that the signal handling capacity is limited owing to the straight characteristics. As a detector valve, however, it very definitely has its uses and, in addition, has many special laboratory uses. In particular it is very suitable as a dynatron oscillator in wave meters.

### TECHNICAL DATA

For Super H.F. Amplification.

Filament Voltage	.. .. .	2
Filament Current (Amps.)	.. .. .	.2
Impedance (ohms)	.. .. .	200,000
Amplification Factor	.. .. .	320
Mutual Conductance	.. .. .	1.6 m.a./v.
Inter-electrode capacity of the order of	.. .. .	.001 $\mu\mu$ F.
Maximum Anode Voltage	.. .. .	150
Grid Bias for economy of H.T. current*	.. .. .	-1.5 v.
Anode Current (Va. = 150) grid return to L.T.-	.. .. .	3.1 m.a.
Anode Current (Va. = 150) -1.5 volt Grid Bias	.. .. .	.7 m.a.
Normal Working Anode Voltage	.. .. .	120
Positive Voltage on Screened Grid	.. .. .	60-80

\*For maximum amplification use no grid bias.

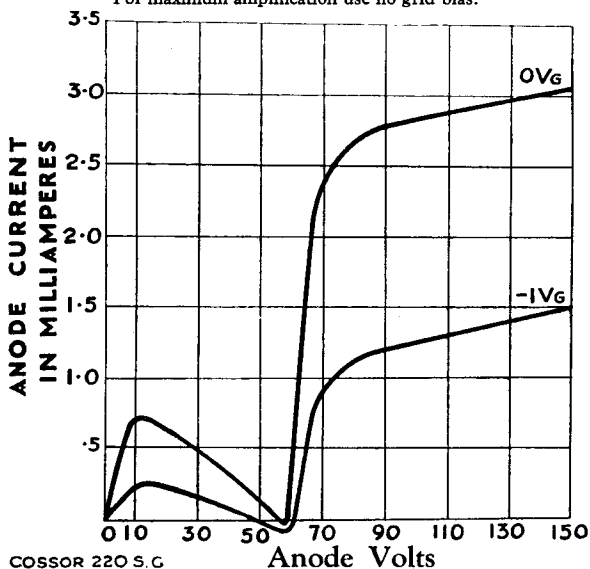

# COSSOR 210 P.G.

## 2-VOLT PENTAGRID

The Cossor 210 P.G. is a 2-volt battery variable-mu pentagrid valve requiring only .1 amp. for filament heating. The valve consists of five grids in addition to the usual filament and anode. It is designed for use as a frequency changer in a superheterodyne receiver.

It provides a very convenient solution to the problem of frequency changing in battery sets. No external coupling is necessary for injecting the oscillator input into the detector circuit and, in addition, the valve can be controlled in an automatic volume control receiver. The filament and anode current consumptions have been kept as low as possible, but in spite of this, the conversion conductance of the valve is of a high order, so that the 210 P.G. is exceptionally efficient.

The valve's inherent freedom from oscillator harmonics gives freedom from the whistles which occur at certain tuning points, unavoidable with certain other frequency changing systems without extremely selective aerial tuning.

### TECHNICAL DATA

Filament Volts	..	..	..	..	2
Filament Current (Amps.)	..	..	..	..	.1
Mod. Anode Voltage (Max.)	..	..	..	..	150
Screen Voltage (Max.)	..	..	..	..	80
Mod. Grid Voltage (Variable)	..	..	..	..	0-9
Osc. Anode Voltage (Max.)	..	..	..	..	150

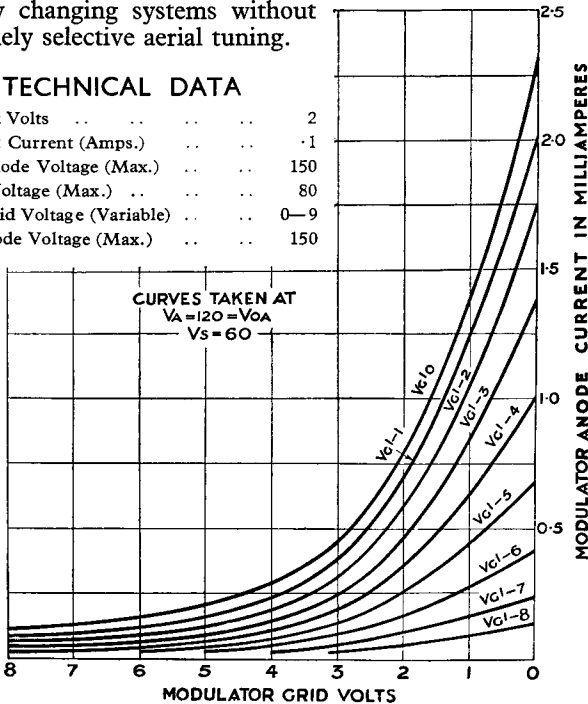

---

---

# COSSOR 220 D.D.

---

---

## 2-VOLT DOUBLE DIODE

The 220 D.D. is a valve designed primarily for use in sets in which automatic volume control is to be provided and is the only battery indirectly heated valve made. It consists of two diodes, one of which is intended for detection of the signal, while the other provides the voltage necessary for A.V.C. These derive their electron current from the same cathode. The 220 D.D. in many cases should be followed by a stage of L.F. amplification which precedes the output valve ; for this purpose the user has a wide choice of valves (e.g. triode, variable- $\mu$  screened pentode, etc.) to suit the particular conditions imposed by the output valve. If the diode is used in combination with the high sensitivity Cossor output pentode 220 H.P.T., however, the L.F. stage may be dispensed with and the 220 H.P.T. may be fed directly from the diode. This method is particularly recommended. By using one of the diodes to provide the A.V.C. voltage, it becomes possible to prevent the A.V.C. System from coming into operation unless the signal would overload the output valve in its absence. In this way the sensitivity of the receiver is in no way impaired by adding automatic volume control to it. Such a system, in which A.V.C. only comes into use on a signal exceeding some pre-arranged strength, is called "delayed A.V.C."

In the 220 D.D., voltage delay is arranged by a small positive voltage on the cathode obtained from a high resistance potentiometer across the H.T. supply. No current will flow until the peak voltage of the signal exceeds the delay voltage, after which rectification will take place in the normal way, providing a D.C. voltage change which can be passed back to the grids of the preceding variable- $\mu$  amplifier valves to control the sensitivity of the set. The return circuit for the signal diode is made to cathode so that it is not affected by the delay voltage.

It is to be noted that no useful purpose is served in fitting automatic volume control to sets with inadequate H.F. gain as no L.F. overloading will occur in these cases.

# COSSOR 210 R.C.

## 2-VOLT TRIODE

Essentially a valve of very high impedance, the 210 R.C. is somewhat restricted in its application. It has, however, a wide application as a replacement in sets designed a year or two ago, where valves of very high impedance were very popular in the detector stage.

The high amplification factor makes this valve very suitable for use where the input is rather small. If followed by a transformer, which must have a very high primary impedance, the overall stage gain is high. When the input to the detector is relatively large, the 210 H.L. is preferable.

### TECHNICAL DATA

For Resistance Capacity Coupling.	
Filament Voltage .. .. .	2
Filament Current (Amps.) .. .	.1
Impedance (ohms) .. . . .	50,000
Amplification Factor .. . . .	40
Mutual Conductance .. . . .	8 m.a./v.
Maximum Anode Voltage .. . .	150
Grid Bias for 150 Anode Volts ..	-1.5 v.
Anode Current for 150 Anode Volts with -1.5 volt Grid Bias (Average) ..	85 m.a.
Normal Anode Working Voltage (approx.)	120

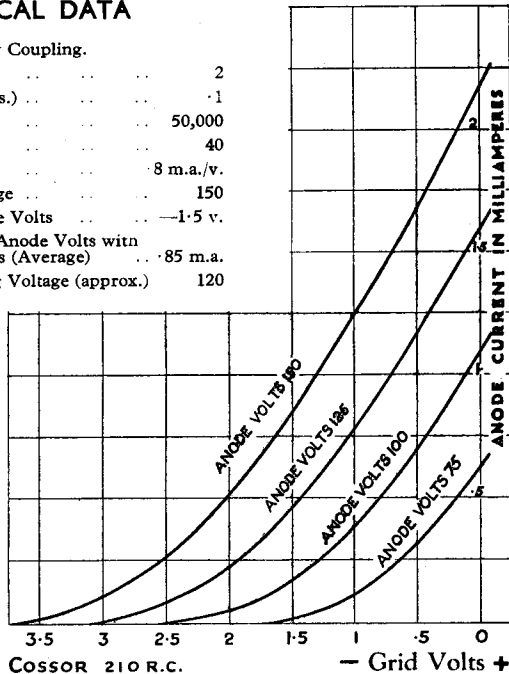

# COSSOR 210 H.L.

## 2-VOLT TRIODE

This valve is probably the most popular Cossor valve in the battery series for use in the detector stage. Its characteristics are such as to suit it for use as a leaky grid detector in combination with small L.F. transformers. Under these conditions sufficient output is obtained to load a small output pentode or triode before overload occurs. In addition, the anode consumption is small, a consideration in receivers using H.T. batteries.

The valve, in common with most other Cossor battery valves for use as H.F. or I.F. amplifiers, or as detectors, is fitted with seven point filament suspension. No microphony need therefore be feared as filament vibration is completely damped.

### TECHNICAL DATA

Filament Voltage	2
Filament Current (Amps.)	.1
Impedance (ohms)	22,000
Amplification Factor	24
Mutual Conductance	1.1 m.a./v.
Maximum Anode Voltage	150
Grid Bias for 150 Anode Volts	-3 v.
Anode Current for 150 Anode Volts with -3 volts Grid Bias (Average)	1.6 m.a.
Normal Working Anode Voltage (approx)	50-120

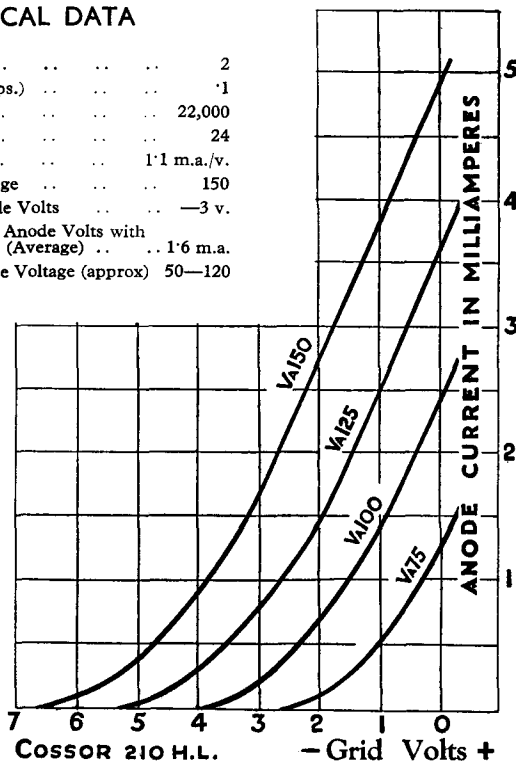

# COSSOR 210 H.F.

## 2-VOLT TRIODE

This valve is very similar to the 210 H.L. with the exception that the mutual conductance is somewhat higher. In consequence its sensitivity is somewhat greater, a quality which may be of advantage in sets with only moderate H.F. gain.

As in the case of the 210 H.L., special precautions have been taken to ensure that no microphonic noise is present.

### TECHNICAL DATA

Filament Voltage .. .. .	2
Filament Current (Amps.) .. .. .	.1
Impedance (ohms) .. .. .	15,800
Amplification Factor .. .. .	24
Mutual Conductance .. .. .	1.5 m.a./v.
Maximum Anode Voltage .. .. .	150
Grid Bias for 150 Anode Volts .. .. .	-3 v.
Anode Current for 150 Anode Volts with -3 volts Grid Bias (Average) .. .. .	1.6 m.a.
Normal Anode Working Voltage (approx.)	50—120

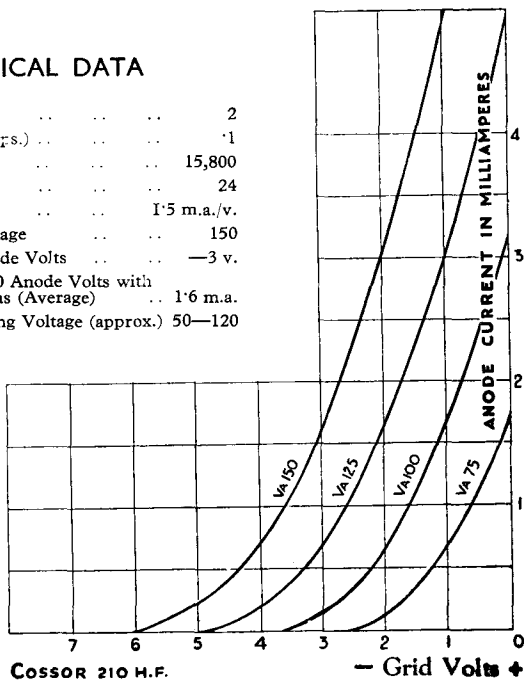

# COSSOR 210 DET.

## 2-VOLT SPECIAL DETECTOR

The 210 DET. has been specially designed for those battery sets in which it is essential that the detector will accept a fairly large signal before overload commences. It will be noted that its impedance at the conventional  $V_a$  100,  $V_g$  0, is 13,000 ohms, somewhat lower than the usual 20,000—25,000 ohms.

The valve is fitted with all precautions against microphonic noise and will be found to be a good general purpose detector valve. In addition it is suitable for use as a small L.F. amplifier.

### TECHNICAL DATA

For Detector Stage.

Filament Voltage	2
Filament Current (Amps.)	.1
Impedance (ohms)	13,000
Amplification Factor	15
Mutual Conductance	1.15 m.a./v.
Maximum Anode Voltage	150
Normal Anode Working Voltage (approx.):	
Grid Leak Rectification	50—90
Anode Bend Rectification	120—150

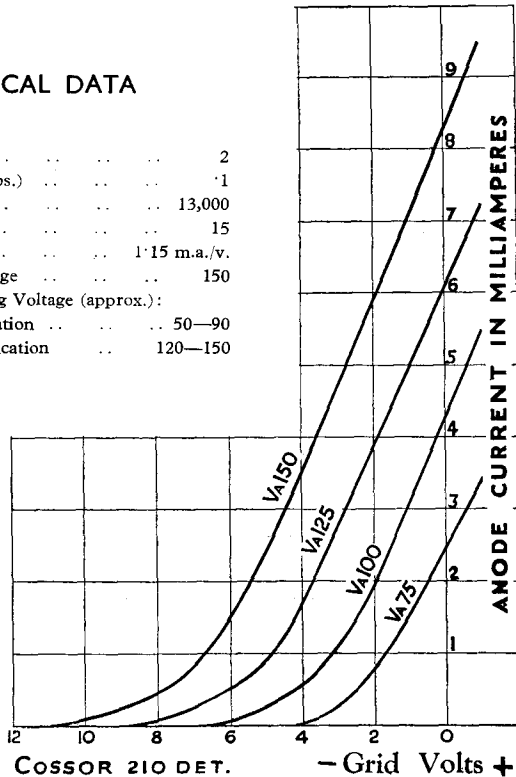



# COSSOR 210 L.F.

## 2-VOLT TRIODE

This valve is primarily intended for use in the first low frequency stage, but it has many other useful applications. The 210 L.F. is recommended as being a useful valve as the driver for a Class "B" Stage in combination with the 220 B.

Full output from the Class "B" valve must not be expected when the 210 L.F. is used as a driver, but the highest economy in anode current is obtained, combined with adequate volume for all domestic purposes.

### TECHNICAL DATA

For First L.F. Amplifier.

Filament Voltage .. .. .	2
Filament Current (Amps) .. .. .	.1
Impedance (ohms) .. .. .	10,000
Amplification Factor .. .. .	14
Mutual Conductance .. .. .	1.4 m.a./v.
Maximum Anode Voltage .. .. .	150
Grid Bias for 150 Anode Volts .. .. .	-4½ v.
Anode Current for 150 Anode Volts with -4½ volts Grid Bias (Average) .. .. .	4.8 m.a.
Normal Anode Working Voltage (approx.)	100—120

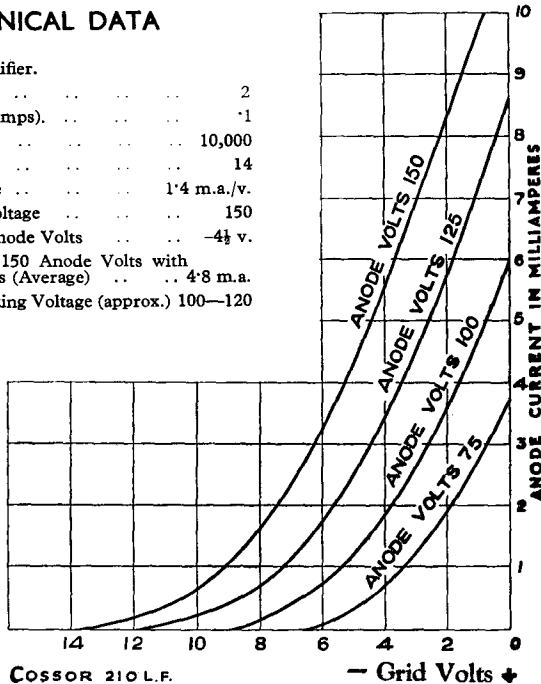

# COSSOR 215 P.

## 2-VOLT POWER VALVE

The Cossor 215 P. is a power valve designed for use in the output stage of receivers operating with high resistance speakers of the reed or balanced armature type. Under these conditions, it will provide good volume for an H.T. consumption of 6—10 m.a. Choke filter output is unnecessary under these conditions. When used with medium or low resistance speakers, a condenser having a value between .002 and .01 mfd. should be connected between the anode of the valve and H.T. — in order to maintain an even frequency response.

### TECHNICAL DATA

For Normal Power Work.

Filament Voltage .. .. .	2
Filament Current (Amps.) .. .. .	.15
Impedance (ohms) .. .. .	4,000
Amplification Factor .. .. .	9
Mutual Conductance .. .. .	2.25 m.a./v.
Maximum Anode Voltage .. .. .	150
Grid Bias for 150 Anode Volts .. .. .	7½ v.
Anode Current for 150 Anode Volts with -7½ volts Grid Bias (Average) .. .. .	10 m.a.
Normal Anode Working Voltage (approx.)	120
Optimum Load .. .. .	9,000 ohms

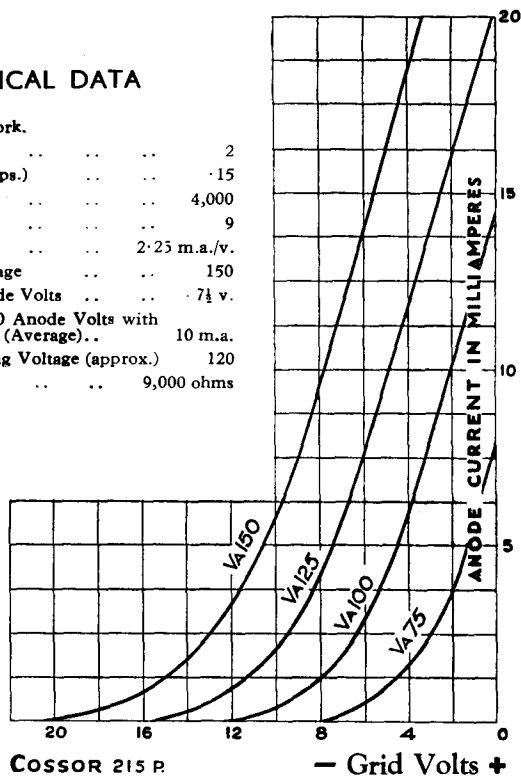

# COSSOR 220 P.

## 2-VOLT POWER VALVE

The 220 P. is a valve very similar to the 215 P. with the exception that its dynamic curve shows a mutual conductance slightly better maintained than in the 215 P., consequently the efficiency is a little improved.

The valve may be used as an output valve with reed or balanced armature speakers, or as the driver in a Class "B" stage in combination with the 220 B or 240 B. Full volume may be obtained from both these valves using the 220 P. as a driver.

### TECHNICAL DATA

For Normal Power Work.

Filament Voltage .. .. .	2
Filament Current (Amps.) .. .. .	.2
Impedance (ohms) .. .. .	4,000
Amplification Factor .. .. .	9
Mutual Conductance .. .. .	2.25 m.a./v.
Maximum Anode Voltage .. .. .	150
Grid Bias for 150 Anode Volts .. .. .	-7.5 v.
Anode Current for 150 Anode Volts with -7.5 volts Grid Bias (Average)	11 m.a.
Normal Anode Working Voltage (approx.)	120
Optimum Load .. .. .	9,000 ohms

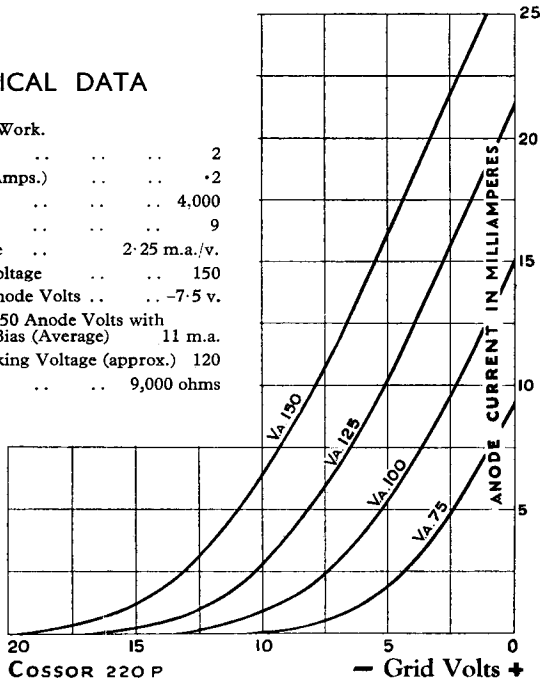

# COSSOR 220 P.A.

## 2-VOLT HIGH SLOPE POWER VALVE

This valve develops approximately the same A.C. output as the 220 P. It is, however, much more sensitive owing to its high value of mutual conductance. It should be used when full volume is not attained with a 220 P. due to low sensitivity.

Attention is drawn to the fact that the 220 P.A. is very strongly recommended as the best battery valve for both power-grid and anode-bend detection when adequate anode current and voltage are available. For the former purpose the transformer should be shunt fed, using a 15,000 ohm resistance with a condenser of .5 to 1 mfd.

### TECHNICAL DATA

For Normal Power Work.	
Filament Voltage	2
Filament Current (Amps.)	.2
Impedance (ohms)	4,000
Amplification Factor	16
Mutual Conductance	4 m.a./v.
Maximum Anode Voltag.	150
Grid Bias for 150 Anode Volts	-4.5 v.
Anode Current for 150 Anode Volts with -4.5 volts Grid Bias (Average)	10 m.a.
Normal Anode Working Voltage (approx.)	120
Optimum Load	9,000 ohms

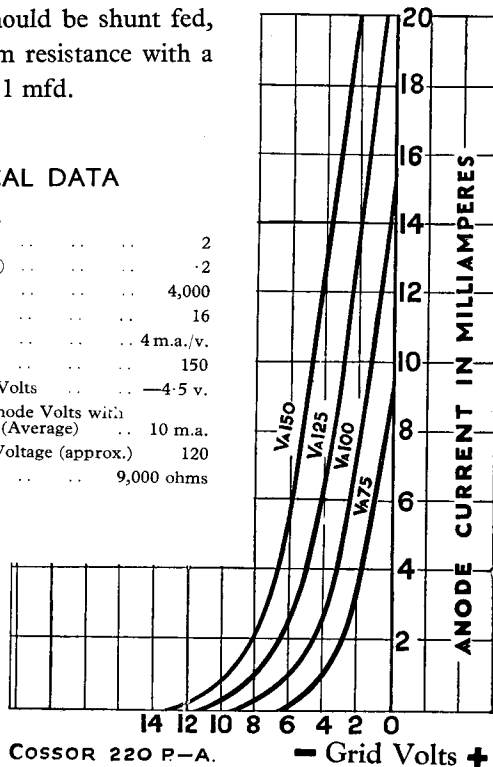

# COSSOR 230 X.P.

## 2-VOLT SUPER POWER

The 230 X.P. is a super-power valve, and has the lowest impedance and highest undistorted output of its class. It has a high standing anode current and requires a large signal voltage. In consequence, its main use is found in receivers or amplifiers using H.T. eliminators and which have a preceding L.F. amplifier. The volume and quality of the reproduction under these conditions is, however, extremely good. The valve may be used with a small moving coil permanent magnet speaker.

Two 230 X.P. valves may be used with advantage in a push-pull stage when considerably greater volume can be obtained than with two valves in parallel.

### TECHNICAL DATA

For Extra Power Use.	
Filament Voltage . . . . .	2
Filament Current (Amps) . . . . .	.3
Impedance (ohms.) . . . . .	1,500
Amplification Factor . . . . .	4.5
Mutual Conductance . . . . .	3 m.a./v.
Maximum Anode Voltage . . . . .	150
Grid Bias for 150 Anode Volts . . . . .	-18 v.
Anode Current for 150 Anode Volts with -18 volts Grid Bias (Average) . . . . .	22 m.a.
Normal Working Anode Voltage (approx.)	120-150
Optimum Load . . . . .	3,500 ohms

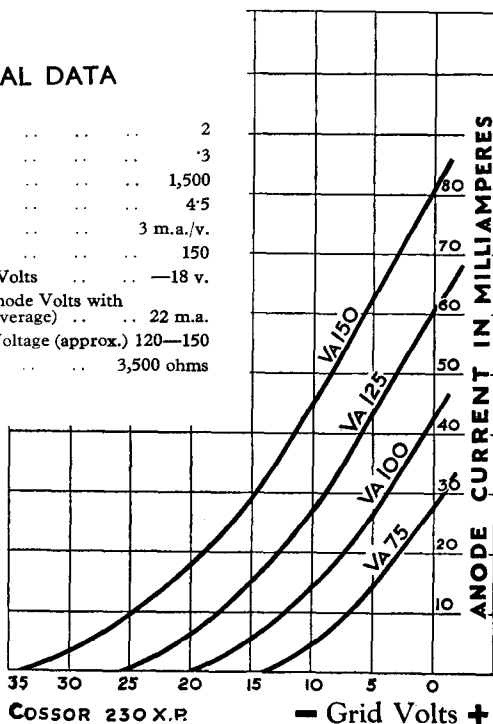

# COSSOR 240 B

## 2-VOLT CLASS B

The Cossor 240 B. is a special valve comprising two separate triodes in one bulb for use in the output stage of a receiver. When used with a driver valve in the manner described on page 33, it is capable of giving very large output for small average High Tension consumption, the reason being that this special form of output, Class B, draws only sufficient current for the actual work to be done at any instant, and practically nothing during programme intervals.

### TECHNICAL DATA.

Filament Volts	.. ..	2.0
Filament Amps. (Total)	.. ..	.4
Anode Volts (Normal)	.. ..	120
Max. Anode Current Swing	.. ..	50 m.a.
Max. Peak Applied Signal (Grid to Grid)	.. ..	40 v.
Average Anode Current when working with 120 volts on anode:		
Without Driver	.. ..	8.5 m.a.
With 215 P. Driver	.. ..	11 m.a.
Static Anode Current at		
Va. 100, Vg. 0 (each half)	.. ..	1.5 m.a.
Anode to Anode Load :		
90 volts anode	.. ..	10,000 ohms
120 volts anode	.. ..	8,000 ohms

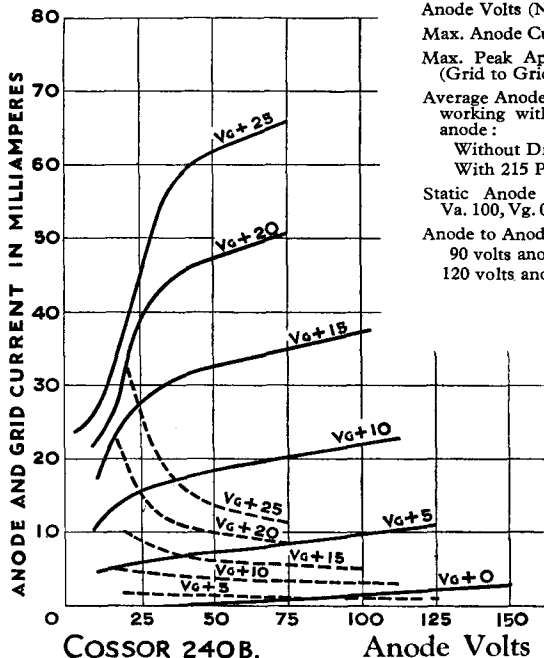

# COSSOR 220 B.

## 2-VOLT CLASS B

The 220 B. is very similar to the 240 B., but has a lower filament consumption and somewhat smaller output. When filament consumption is a consideration, this valve should be chosen unless very great volume is required. The 220 B. will give volume somewhere about 8 times that available from a standard power valve, while consuming less H.T. current. The 215 P. will be found convenient as a driver, although the 210 L.F. may be used.

### TECHNICAL DATA

Filament Volts	.. .. .	2.0
Filament Amps. (Total)	.. .. .	.2
Anode Volts (Normal)	.. .. .	120
Max. Anode Current Swing	.. .. .	35 m.a.
Max. Peak Applied Signal (Grid to Grid)		40 v.

Average Anode Current when working with 120 volts on anode:

Without Driver	..	6 m.a.
With 215 P. Driver	..	7.5 m.a.

Static Anode Current at } (each half) 1.25 m.a.  
 $V_a$  100  $V_g$  0 }

Anode to Anode Load:

90 volts anode	..	20,000 ohms
120 volts anode	..	12,000 ohms

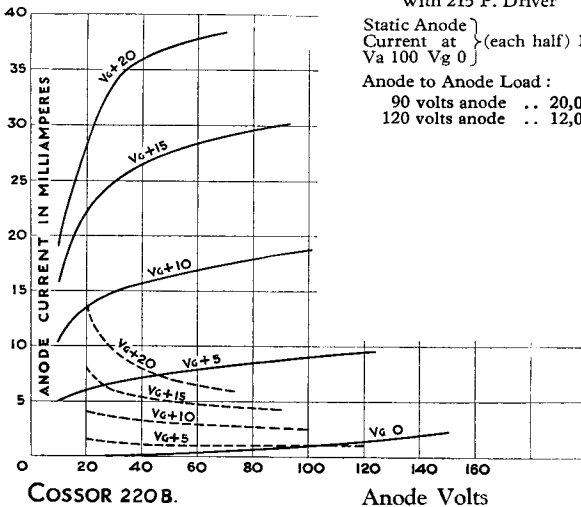

# COSSOR 220 H.P.T.

## 2-VOLT ECONOMY PENTODE

The 220 H.P.T. is a pentode valve that will give a generous output for a very small value of high tension current.

The sensitivity of the valve is of a high order, and it is therefore particularly suitable for use when the input is small.

By a suitable adjustment of screen and grid bias voltages, this valve may be adjusted to work with very small anode current. Even when the anode current is cut down as low as 4 m.a., the undistorted output available is much greater than that obtainable from an ordinary power valve consuming twice as much current. This is due to the high efficiency of a correctly designed pentode.

### TECHNICAL DATA

For Pentode Power Output.

Filament Voltage .. .. .	2
Filament Current (Amps.) .. .. .	·2
Mutual Conductance .. .. .	2·5 m.a./v.
Maximum Anode Voltage .. .. .	150
Maximum Screen Voltage .. .. .	150
Grid Bias for Maximum Anode and Screen Voltage .. .. .	- 4·5
Anode Current for Maximum Anode and Screen Volts with - 4·5 volts bias .. .. .	8·0 m.a.
Optimum Load .. .. .	17,000 ohms

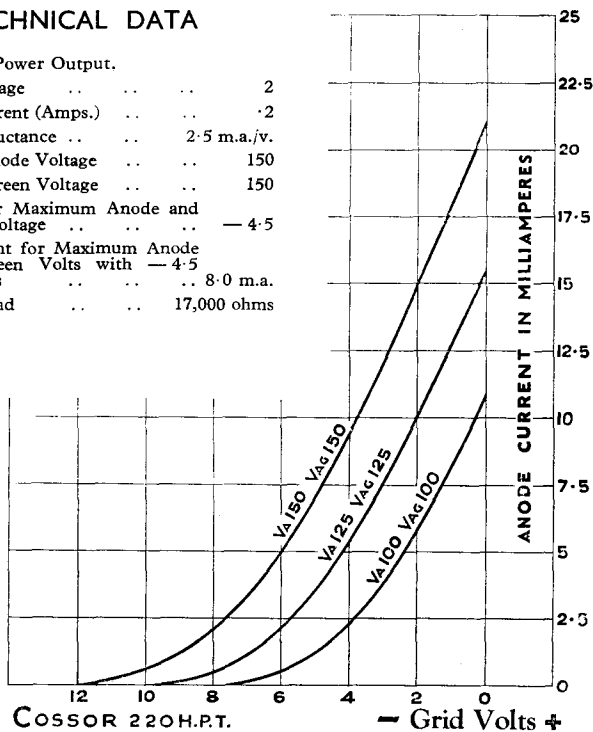



# COSSOR 220 P.T.

## 2-VOLT POWER PENTODE

The 220 P.T. has an exceptionally high value of undistorted output, and is therefore very suitable for using with a moving-coil loud speaker. Care should be taken to match correctly the speaker to the valve if the former is not specially designed for use with a pentode valve.

To obtain the full advantage of a pentode valve with the average moving-iron loud speaker a "Corrector Circuit" should be used. This circuit is very simple, consisting only of a condenser of 0.01 mfd. and resistance of 10,000 ohms, joined in series across the speaker terminals. The exact values cannot be prescribed, because they depend on the make of loud speaker; those given are reasonably satisfactory in most cases.

### TECHNICAL DATA

For Pentode Power Output.

Filament Voltage .. .. .	2
Filament Current (Amps.) .. .. .	0.2
Mutual Conductance .. .. .	2.5 m.a./v.
Maximum Anode Voltage .. .. .	150
Maximum Screen Voltage .. .. .	150
Grid Bias for Maximum Anode and Screen Voltage .. .. .	- 9 volts
Anode Current for Maximum Anode and Screen Volts with - 9 volts bias .. .. .	19 m.a.
Optimum Load .. .. .	7,500 ohms

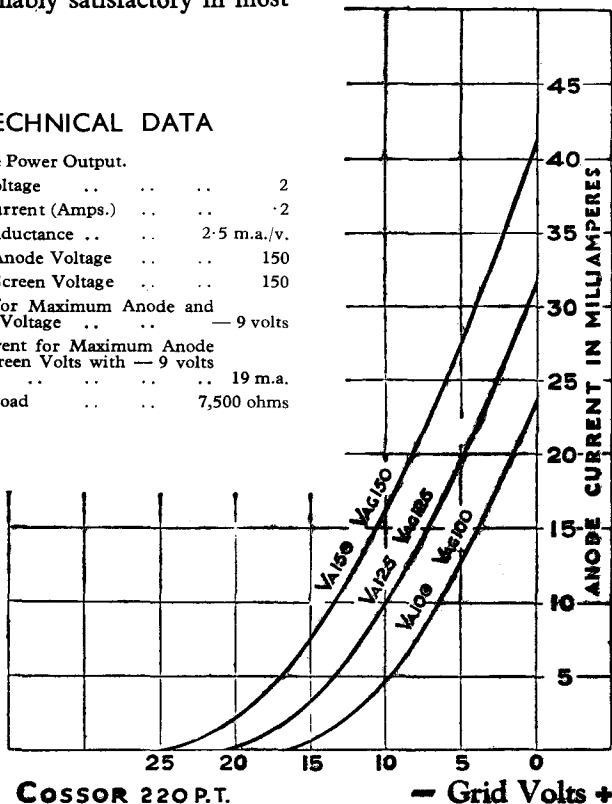

---

# COSSOR

## Indirectly Heated Mains Valves

---

4-VOLT 1 AMP. SERIES

The valves in this series have indirectly heated cathodes and incorporate heaters suitable for use at 4 volts, and these valves are, therefore, particularly suitable for use in A.C. receivers, and may be used as replacements in any A.C. mains set using indirectly heated valves.

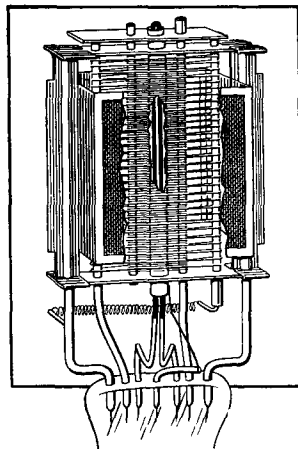

**Cossor  
41 M.H.**

Cathode cut  
away showing  
heater.

# COSSOR M.V.S./PEN.

4-VOLT 1 AMP. INDIRECTLY HEATED  
VARIABLE MU. H.F. PENTODE.

The Cossor M.V.S./PEN. is a variable-mu high frequency screened pentode. It is particularly useful as a high frequency or intermediate frequency amplifier. Its variable-mu characteristic permits of manual volume control by means of variation of grid bias, or of the application of automatic volume control. The suppressor grid is brought out to a separate pin in the seven-pin base type, which makes possible the use of the valve in various special ways, such as for frequency changing. In addition, negative potential applied to this grid will greatly decrease the impedance—a function that may be used in special sets for simultaneously decreasing the gain and flattening the tuning, permitting the most perfect quality from the local station. The valve is also available with five-pin base where the suppressor grid is connected to cathode.

## TECHNICAL DATA

Heater Voltage .. .. .	4
Heater Current (Amps.) .. .. .	1
Maximum Anode Voltage .. .. .	200
Maximum Auxiliary Grid Voltage .. .. .	100
Mutual Conductance at Va. 200, Vag. 100, Vg. 0 .. .. .	3.0 m.a./v.
At Va. 200, Vag. 100, Vg. -1.5 .. .. .	2.2 m.a./v.
Grid Voltage (Variable) .. .. .	.0 to -20

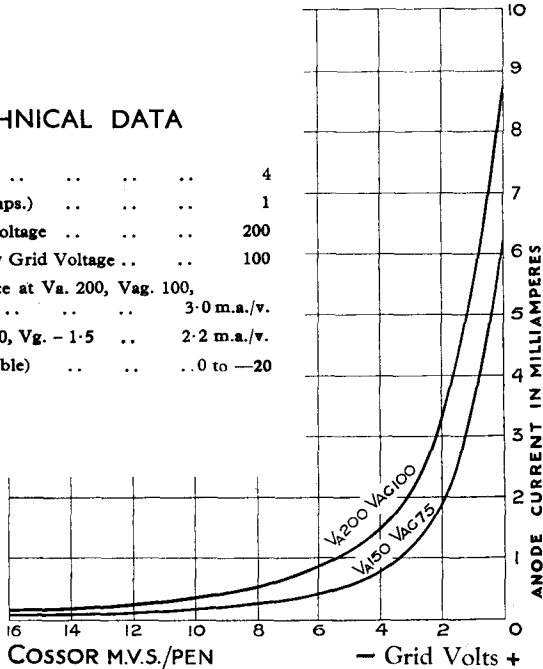

# COSSOR M.V.S.G.

## 4-VOLT 1 AMP. INDIRECTLY HEATED VARIABLE $\mu$ . SCREENED GRID

This is a specialised type of screened valve which, when correctly used, has several important advantages over the ordinary type. The special form of its grid-volts anode-current characteristic is such as to permit of volume control by means of a variation of grid bias—a system which is convenient in application and has no adverse effect upon tuning or quality.

### TECHNICAL DATA

Heater Voltage .. .. .	4						
Heater Current (Amps.) .. .	1						
Maximum Anode Voltage .. .	200						
Maximum Screened Voltage .. .	100						
Impedance .. .	200,000						
	<table border="0" style="margin-left: 20px;"> <tr> <td><math>V_a</math></td> <td>200</td> </tr> <tr> <td>at <math>V_{sg}</math></td> <td>80</td> </tr> <tr> <td><math>V_g</math></td> <td>-1.5</td> </tr> </table>	$V_a$	200	at $V_{sg}$	80	$V_g$	-1.5
$V_a$	200						
at $V_{sg}$	80						
$V_g$	-1.5						
Mutual Conductance 2.5 m.a./v.							
Inter-electrode Capacity of the order of .. .	.001 $\mu\mu$ F						
Anode Current for Anode Volts 200, Screen Volts 80, Grid Bias -1.5	7.8 m.a.						
Normal Screen Grid Voltage .. .	80						
Grid Bias (Variable) .. .	-1.5 to -35 v.						

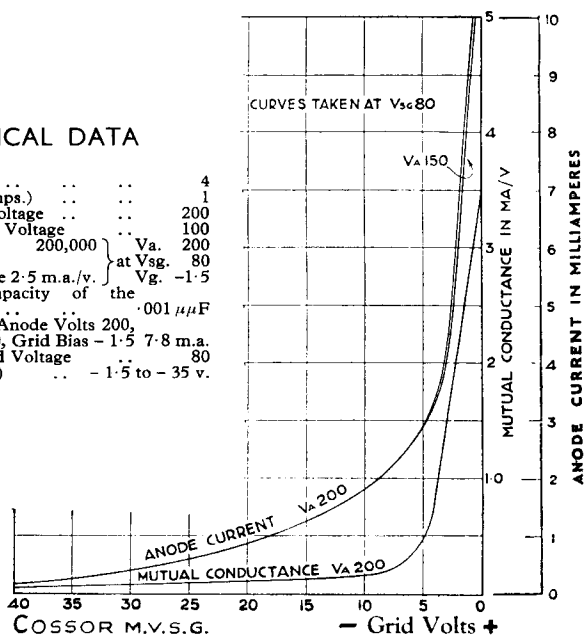

# COSSOR M.S./PEN.

## 4-VOLT 1 AMP. INDIRECTLY HEATED H.F. PENTODE

This valve is similar to the M.V.S./PEN., but has no variable-mu characteristics. It may be used in place of an ordinary screen grid valve, or may be used for any of the functions suggested for the M.V.S./PEN. where bias volume control is not required, and where the signal voltage to be amplified is not large. Another use for this valve is in the detector stage, where it offers possibilities of very high gain combined with complete stability. The suppressor grid of this valve is brought out to a separate pin in the case of the seven-pin base type; in the case of the five-pin base type, the suppressor grid is connected to cathode. The metallised coating is also brought out to a separate pin, which is often very convenient.

### TECHNICAL DATA

Heater Voltage .. .. .	4
Heater Current (Amps.) .. .. .	1
Maximum Anode Voltage .. .. .	200
Maximum Auxiliary Grid Voltage .. .. .	100
Mutual Conductance at $V_a$ 200, $V_{g_2}$ 100, $V_{g_3}$ 0	3.5 m.a./v.
At $V_a$ 200, $V_{g_2}$ 100, $V_{g_3}$ -1.5	2.8 m.a./v.

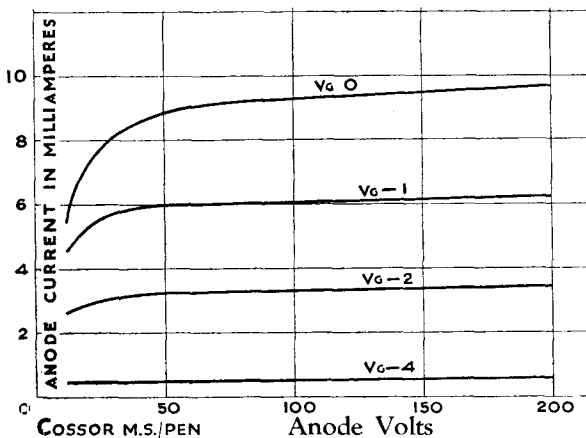

# COSSOR M.S.G./H.A.

## 4-VOLT 1 AMP. INDIRECTLY HEATED SCREENED GRID

This valve is a screened grid valve having a high amplification factor. It has been very largely used as an H.F. amplifier, and is well suited for this purpose providing that the signal to be amplified is small.

The inter-electrode capacity is the same as that of the battery valve, which is of the order of .001 micro-microfarads, which permits the valve when used in conjunction with suitable coils to develop a high stage gain, stability being perfectly maintained. For maximum stage gain this valve should be used with a coupling having the equivalent to a ratio of 1 : 1, which may take the form of a tuned transformer of this ratio, or alternatively untapped tuned grid or untapped tuned anode coupling.

### TECHNICAL DATA

For Super H.F. Amplification.

Heater Voltage .. .. .	..	..	
Heater Current (Amps.) ..	..	1	
Maximum Anode Voltage ..	..	200	
Maximum Screen Voltage ..	..	100	
Impedance .. 500,000	} at Vsg. 80	Va. 200	Vg. -1.5
Amplification Factor 1000			
Mutual Conductance .. .			

Anode Current for Anode Volts	150, Screen Volts 80, Grid	
Bias -1.5 .. .. .	..	2.1 m.a.
Normal Working Anode Voltage	..	150
Screen Grid Voltage (normal)	..	60-80
Grid Bias (Bias Resistance 600 ohms)	.. .. .	-1.5 v.

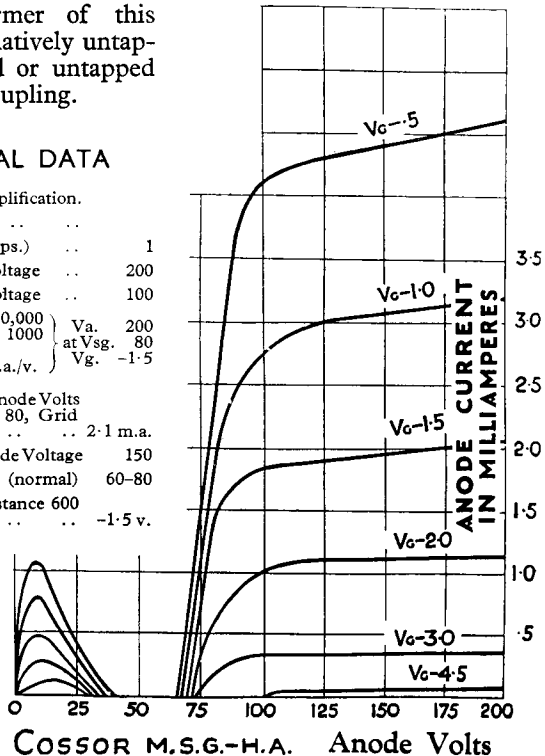

# COSSOR M.S.G./L.A.

## 4-VOLT 1 AMP. INDIRECTLY HEATED SCREENED GRID

This valve has a considerably lower amplification factor than the M.S.G./H.A., but has a very high value of mutual conductance for such a valve. Its gain, therefore, will be even larger than the M.S.G./H.A. if the correct coupling is used. Here again, the valve is not suited for the amplification of large signals.

The M.S.G./L.A. permits considerable scope and latitude in design, as for both maximum stage gain and selectivity a step-up ratio of several times is desirable in the coupling. The inter-electrode capacity is very low, of the order of .001 micro-microfarads, which with the step-up coupling makes it impossible for the point of instability to be reached if the set is correctly screened.

### TECHNICAL DATA

For Super H.F. Amplification.			
Heater Voltage	..	..	4
Heater Current (Amps.)	..	..	1
Maximum Anode Voltage	..	..	209
Maximum Screen Voltage	..	..	100
Impedance	..	200,000	} at Vg. 80
Amplification Factor	750	Va. 200	
Mutual Conductance	3.75 m.a./v.	Vg. -1.5	
Anode Current for Anode Volts			
150, Screen volts 80, Grid Bias -1.5	..	..	5.2 m.a.
Normal Anode Working Voltage	..	..	150
Screen Grid Voltage (normal)	..	..	60-80
Grid Bias (Bias Resistance 250 ohms)	..	..	-1.5 v.

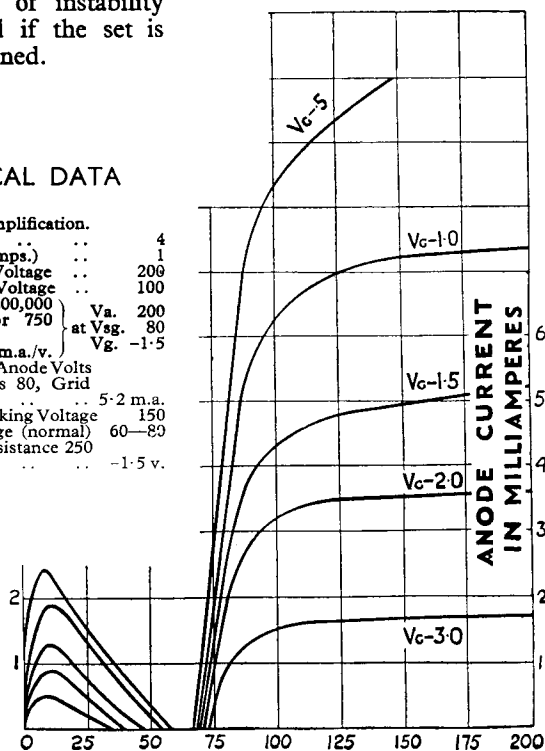

COSSOR M.S.G.-L.A. Anode Volts

# COSSOR 41 M.P.G.

## 4-VOLT 1 AMP. INDIRECTLY HEATED PENTAGRID FREQUENCY CHANGER

The Cossor 41 M.P.G. is a variable-mu pentagrid valve, and is intended for frequency changing in a superheterodyne receiver, in which position it takes the place of the first detector and oscillator. The valve derives its nomenclature from the fact that it has five grids in addition to anode, cathode and heater.

Up to the introduction of this valve the problem of single valve frequency changing had been solved with only partial success, but the Cossor Pentagrid provides a complete and efficient solution devoid of the drawbacks of previous methods. The Cossor Pentagrid is distinguished by its high conversion conductance and inherent freedom from oscillator harmonics, two factors of vital importance in the design of the modern Superheterodyne Receiver.

### TECHNICAL DATA

Heater Voltage	.. .. .	4
Heater Current (Amps.)	.. .. .	1
Mod. Anode Voltage (Max.)	.. .. .	250
Mod. Screen Voltage (Max.)	.. .. .	100
Mod. Grid Voltage (Under recommended working conditions)	.. .. .	-1.5 to -10
Osc. Anode Voltage (Max.)	.. .. .	100

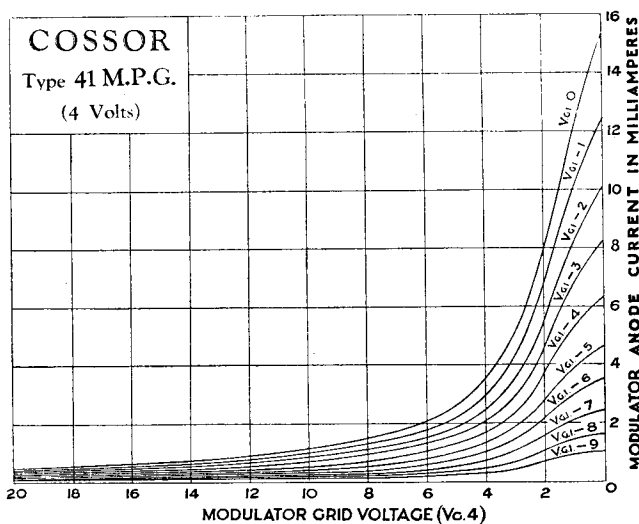



---

---

# COSSOR D.D.4.

---

---

## 4 VOLT 75 AMP. INDIRECTLY HEATED DOUBLE DIODE

The D.D.4 is a valve designed primarily for use in sets in which automatic volume control is to be provided. It consists of two diodes, one of which is intended for detection of the signal, while the other provides the voltage necessary for A.V.C. These derive their electron current from the same cathode. The D.D.4 in many cases should be followed by a stage of L.F. amplification which precedes the output valve ; for this purpose the user has a wide choice of valves (e.g. triode, variable- $\mu$  screened pentode, etc.) to suit the particular conditions imposed by the output valve. If the diode is used in combination with the high sensitivity Cossor output pentode 42 M.P./Pen, however, the L.F. stage may be dispensed with and the 42 M.P./Pen may be fed directly from the diode. This method is particularly recommended. By using a separate diode to provide the A.V.C. voltage, it becomes possible to prevent the A.V.C. System from coming into operation unless the signal would overload the output valve in its absence. In this way the sensitivity of the receiver is in no way impaired by adding automatic volume control to it. Such a system, in which A.V.C. only comes into use on a signal exceeding some pre-arranged strength, is called "delayed A.V.C." In the D.D.4 voltage delay is arranged by a small negative voltage on the anode of the diode which is being used for A.V.C. No current will flow until the peak voltage of the signal exceeds the delay voltage, after which rectification will take place in the normal way, providing a D.C. voltage change which can be passed back to the grids of the preceding variable- $\mu$  amplifier valves to control the sensitivity of the set.

It is to be noted that automatic volume control should only be fitted to receivers having adequate H.F. or I.F. gain. No purpose is served in fitting it to receivers of low sensitivity.

# COSSOR D.D.T.

## 4-VOLT 1 AMP. INDIRECTLY HEATED DOUBLE DIODE TRIODE

The Cossor D.D.T. is intended for Automatic Volume Control, and takes the form of a triode valve with two diodes all sharing the same cathode. One diode is usually used as a normal detector, its rectified output being passed to the grid of the D.D.T. for amplification. The other diode is used to provide a D.C. voltage for use in the amplification control of the preceding valves. Delay may be applied to this diode by supplying a small negative D.C. voltage to its anode. Used in this way, the sensitivity of the set is not impaired, as A.V.C. will not come into play until the incoming signal reaches values greater than the delay voltage.

### TECHNICAL DATA.

Heater Voltage .. .. .	4
Heater Current (Amps.) .. .. .	1
Maximum Anode Voltage .. .. .	200
Impedance (ohms) .. 17,000	} at { $V_a$ 100 $V_g$ 0
Mutual Conductance 2.4m.a./v	
Amplification Factor .. 41	

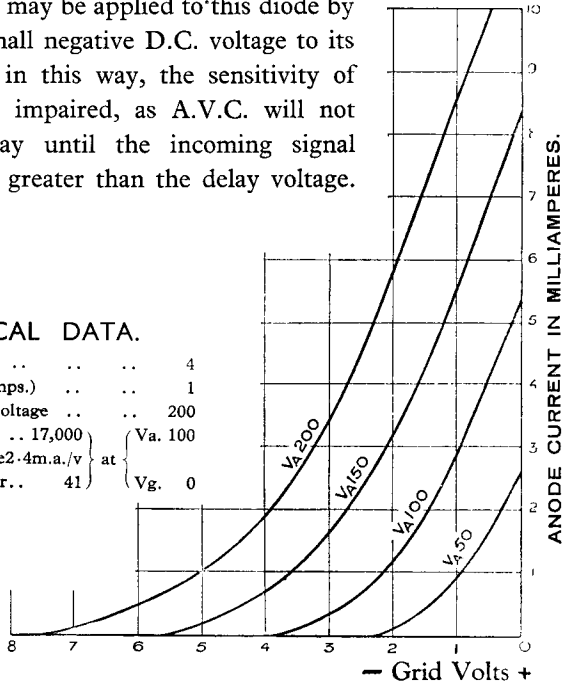

# COSSOR D.D./PEN

## 4-VOLT 1 AMP. INDIRECTLY HEATED DOUBLE DIODE PENTODE

This valve is a special variable-mu L.F. pentode with two small diode valves all sharing a common cathode. This valve is intended for corrected Automatic Volume Control, the gain being varied both in preceding stages and on the pentode portion. This system ensures a very level and perfect control of volume, correcting for the inevitable changes in voltage to the output valve given by more simple systems. Care should be taken, however, to use the values indicated in the instruction slip which accompanies each valve, as variations of coupling will spoil the linearity of volume control.

### TECHNICAL DATA.

Heater Voltage .. .. .	4
Heater Current (Amps.) .. .. .	1
Maximum Anode Voltage .. .. .	250
Maximum Screen Voltage .. .. .	200
Maximum Space Current (Anode + Screen) .. .. .	15 m.a.
Mutual Conductance .. 2.7 m.a./v. } at {	V <sub>a</sub> 200
	V <sub>g</sub> 100
	V <sub>g</sub> 0

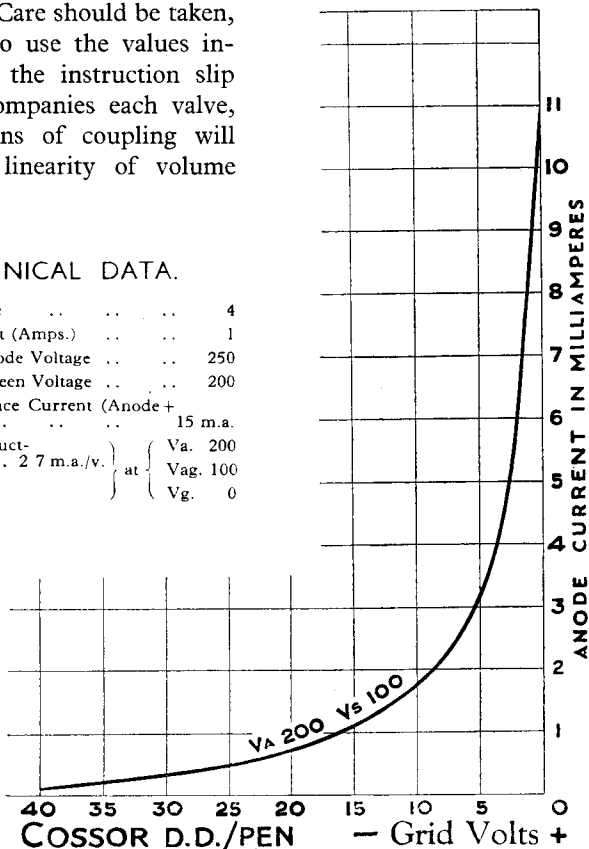

# COSSOR 41 M.H.

## 4-VOLT 1 AMP. INDIRECTLY HEATED TRIODE

The 41 M.H. possesses a relatively high impedance, and a very high value of mutual conductance. Its principle use is as a detector valve, the high value of mutual conductance giving great sensitivity.

Anode bend rectification employing the 41 M.H. is very satisfactory, as the sharp cut-off gives sensitivity well above the average. A coupling resistance of 100,000 ohms is recommended, a condenser of .0002 mfd. being suitable as an anode bypass.

The 41 M.H. is also exceptionally suitable as a power grid detector, when a high value of stage gain is required in this stage.

### TECHNICAL DATA

For Detector.

Heater Voltage .. .. .	4
Heater Current (Amps.) .. .. .	1
Impedance .. .. .	18,000
Amplification Factor .. .. .	72
Mutual Conductance .. .. .	4 m.a./v.
Maximum Anode Voltage .. .. .	200
*Grid Bias for 200 Anode Volts .. .. .	-1.5
Anode Current for 200 Anode Volts with -1.5 volts Grid Bias (Average) .. .. .	3.2 m.a.
Normal Working Anode Voltage .. .. .	150

\* Grid Bias when used as L.F. amplifier.

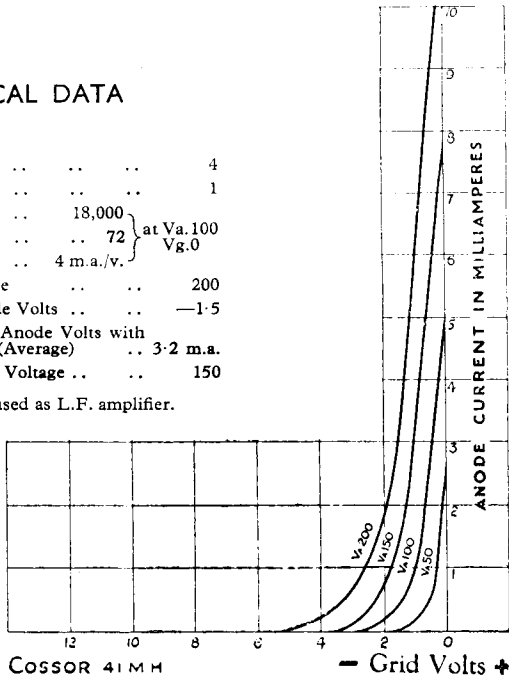

# COSSOR 41 M.H.L.

## 4-VOLT 1 AMP. INDIRECTLY HEATED TRIODE

The 41 M.H.L. has a relatively low impedance and a very high value of mutual conductance. It is admirably suited to work in the detector position when the preceding amplification makes necessary a detector valve of rather low impedance.

As a power grid detector it will be found very sensitive, and in addition will permit of high stage gain. It is recommended that if a transformer follows this valve it should be shunt fed with 30,000 ohms and a coupling condenser of 1 mfd.

When using this valve as an anode bend detector, either resistance capacity coupling or transformer coupling may follow.

### TECHNICAL DATA

For Detector or H.F.				
Heater Voltage .. .. .	..	..	..	4
Heater Current (Amps.) .. .. .	..	..	..	1
Impedance .. .. .	..	..	11,500	} at $V_a.100$ $V_g.0$
Amplification Factor .. .. .	..	..	52	
Mutual Conductance ..	4.5	m.a./v.		
Maximum Anode Voltage .. .. .	..	..	200	
*Grid Bias for 200 Anode Volts .. .. .	..	..	-3 v.	
Anode Current for 200 Anode Volts with -3 volts Grid Bias (Average) .. .. .	..	..	4 m.a.	
Normal Working Anode Voltage .. .. .	..	..	150	
Bias Resistance .. .. .	..	..	750 ohms.	

\* Grid Bias when used as L.F. amplifier.

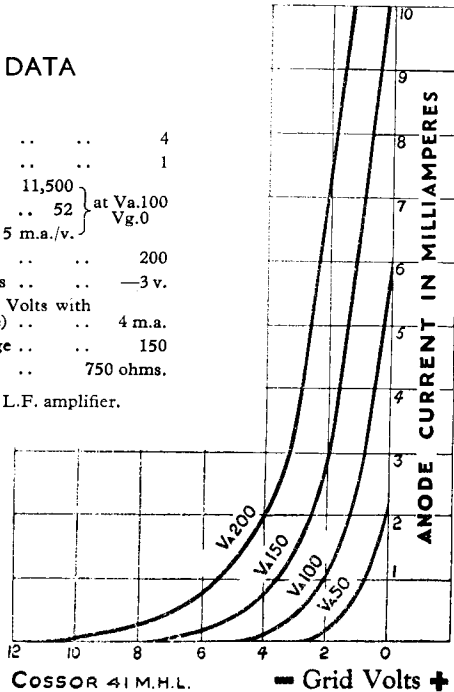

COSSOR 41 M.H.L.

- Grid Volts +

# COSSOR 4 X.P.

## 4-VOLT 1 AMP. DIRECTLY HEATED MAINS POWER OUTPUT

The 4 X.P. is a modern super-power valve capable of supplying considerable output. The efficiency of the valve is good for a triode and the sensitivity, as evidenced by the mutual conductance of 7 m.a./v., is also high. The maximum allowable dissipation at the anode is 12 watts, and this must not be exceeded.

The valve is of the directly heated type and, if automatic bias is used, care must be taken that the resistance across the filament terminals is truly centre tapped, otherwise hum will result. No hum need be feared, however, due to lack of thermal inertia of the filament.

For large radiogram receivers or amplifiers, two of these valves in push-pull give an output adequate for almost all purposes. A large energised speaker should be used.

### TECHNICAL DATA

For Extra Power Use.

Filament Voltage .. .. .	4	
Filament Current (Amps.) .. .. .	1.0	
Impedance (ohms) .. .. .	900	} at $V_a$ 100
Amplification Factor .. .. .	6.3	
Mutual Conductance .. .. .	7 m.a./v.	} at $V_g$ 0
Maximum Anode Voltage .. .. .	250	

WITH A.C. HEATED FILAMENT.

Grid Bias for 250 Anode Volts .. .. .	-28.5 v.
Anode Current for 250 Anode Volts with -28.5 volts Grid Bias (Average)	48 m.a.
Optimum Load (for above conditions)	3,000 ohms
Bias Resistor .. .. .	600 ohms

Should the filament be supplied from a D.C. source the bias values should be decreased by 2 volts, the H.T. and Grid Bias returns being made to the negative L.T.

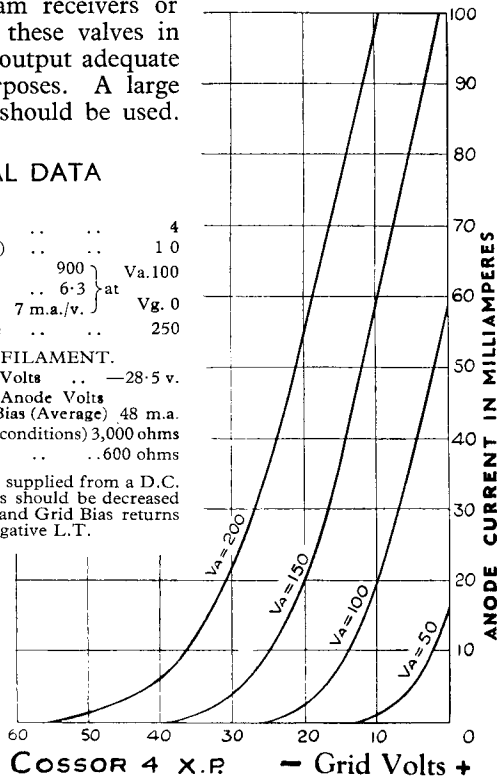

# COSSOR 41 M.P.

## 4-VOLT 1 AMP. INDIRECTLY HEATED POWER OUTPUT

The 41 M.P. is a small triode output valve with an exceptionally high mutual conductance. It is very suitable for use in receivers where a large output is not required but where sensitivity is of primary importance. In these circumstances, the valve is a very convenient one and very pleasing quality is obtained.

The 41 M.P. is very suitable as a power grid or anode bend detector when the amplification of the preceding stages is such that the voltage developed across the grid-cathode circuit of the detector valve has too high an amplitude to allow a valve of higher impedance to be used. Distortion resulting from overload is avoided if this valve is used.

### TECHNICAL DATA

For Normal Power Use.

Heater Voltage .. .. .	4
Heater Current (Amps.) .. .. .	1
Impedance .. .. .	2,500
Amplification Factor .. .. .	18.7
Mutual Conductance .. 7.5 m.a./v.	
	} at $V_g = 0$
Maximum Anode Voltage .. .. .	200
Grid Bias for 200 Anode Volts .. .. .	-7.5
Bias Resistance (ohms) .. .. .	320
Anode Current for 200 Anode Volts with	
-7½ volts Grid Bias .. .. .	24 m.a.
Normal Working Anode Voltage .. .. .	150
Optimum Load (ohms) .. .. .	3000

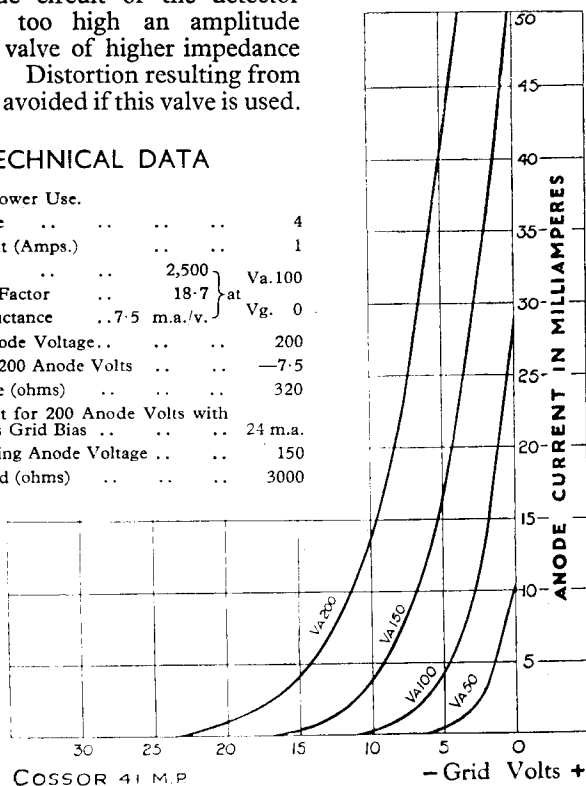

# COSSOR 41 M.X.P.

4-VOLT 1 AMP. INDIRECTLY HEATED  
SUPER POWER OUTPUT

The 41 M.X.P. possesses the same high value of mutual conductance as the 41 M.P., but has a somewhat lower impedance and a relatively larger value of undistorted output. Used under suitable conditions this valve will provide sufficient volume for all domestic purposes.

The sensitivity of the valve is very high, a signal of approximately 8 volts R.M.S. being sufficient to load the valve completely. Owing to the large mutual conductance it is advisable to use a grid stopper resistance and, in some cases, a small resistance in the anode circuit. Both resistances should be as close to the valveholder as possible.

## TECHNICAL DATA

For Extra Power Use.

Heater Voltage .. .. .	4
Heater Current (Amps.) .. .	1
Impedance .. .. .	1,500
Amplification Factor .. .	11.2
Mutual Conductance .. .	7.5 m.a./v.
Maximum Anode Voltage .. .	200
Grid Bias for 200 Anode Volts .. .	-12.5 v.
Normal Working Anode Voltage .. .	150
Anode Current for max. Anode Volts and -12.5 volts Grid Bias .. .	40 m.a.
Bias Resistance (ohms) .. .	300
Optimum Load (ohms) .. .	2,000

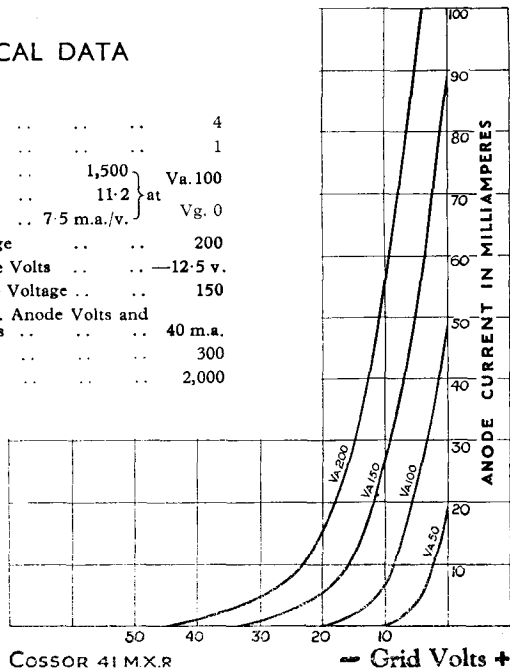



# COSSOR M.P./PEN.

## 4-VOLT 1 AMP. INDIRECTLY HEATED PENTODE

The M.P./PEN. is a medium sensitivity indirectly heated output pentode having a maximum anode dissipation of 8 watts. Such pentode valves have one great advantage as compared with triodes of the same class; this lies in the fact that their efficiency is very much higher. For a given anode voltage, the ratio of watts given out to watts of high tension energy expended is very much higher. Very much larger volume is to be obtained from the M.P./Pen., therefore, than from the 41 M.X.P.

The quality to be obtained from such pentodes has sometimes been adversely criticised. This criticism usually has its origin in the use of an inadequate corrector circuit. This corrector circuit is very simple, consisting only of a condenser of .01 mfd. and a resistance of 10,000 ohms joined in series across the speaker terminals. The exact values depend on the characteristics of the loud speaker, but those given are reasonably satisfactory in all cases.

### TECHNICAL DATA

Heater Voltage	.. ..	4	
Heater Current (Amps.)	.. ..	1	
Mutual Con-	}	Va. 100 Vag. 100 Vg. 0	
ductance			3.5 m.a./v. at
Maximum Anode Voltage	.. ..	250	
Maximum Screen Voltage	.. ..	250	
Grid Bias for 250 Screen Volts	.. ..	-16 v.	
Grid Bias for 200 Screen Volts	.. ..	-10 v.	
Bias Resistance for 250 Screen Volts	.. ..	450 ohms	
Anode Current for 250 Volts with 250 Screen Volts and -16 Volts Grid Bias	.. ..	30 m.a.	
Optimum Load	.. ..	10,000 ohms	

(The Screen Voltage should never exceed the Anode Voltage).

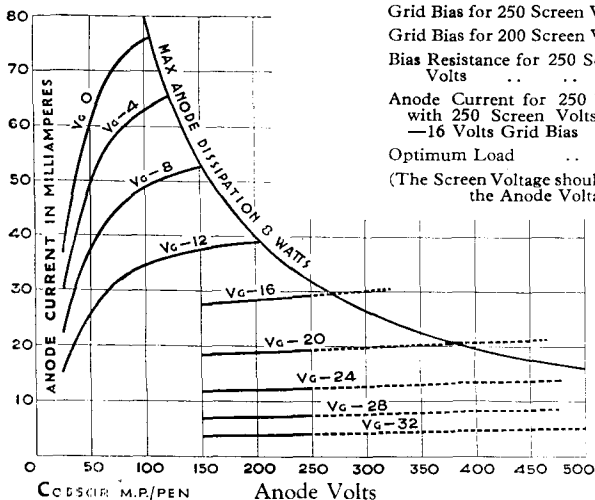

# COSSOR 42 M.P./PEN.

## 4-VOLT 2 AMP. INDIRECTLY HEATED HIGH SLOPE PENTODE

This valve is an indirectly heated pentode output valve capable of giving very large undistorted volume. It is characterised by an exceptionally high slope, which enables it to deliver full output for a very small input. For this reason it may be fed directly from a double diode detector such as the Cossor D.D.4, when the latter is preceded by adequate H.F. amplification as in a Superheterodyne Receiver.

### TECHNICAL DATA

Heater Voltage .. .. .	4
Heater Current (Amps.) .. .. .	2
Mutual Conductance .. .. .	7.0 m.a./v.
Maximum Anode Voltage .. .. .	250
Maximum Screen Voltage .. .. .	250
Grid Bias for 250 volts on Anode and Screen ..	- 5.5 v.
Grid Bias for 200 volts on Anode and Screen ..	- 4 v.
Anode Current for 250 volts on Anode and Screen	32 m.a.
Anode Current for 200 volts on Anode and Screen	28 m.a.
Bias Resistance for 250 volts on Screen and Anode	140 ohms
Bias Resistance for 200 volts on Screen and Anode	120 ohms
Optimum Load .. .. .	8,000 ohms

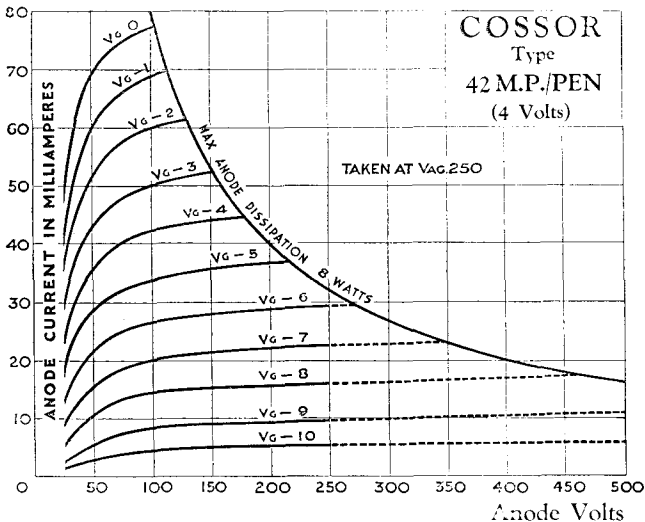

# COSSOR P.T.41

## 4-VOLT 1 AMP. DIRECTLY HEATED PENTODE

The P.T. 41 is a directly heated pentode valve capable of delivering a volume of undistorted output sufficient for all domestic purposes ; at the same time the sensitivity is sufficiently high to permit it to be fully loaded by a detector with transformer coupling.

It is very similar to the M.P./Pen., but may have advantages in certain receivers by virtue of its directly heated filament. Automatic bias is obtained in the usual manner for directly heated valves by the use of a small centre tapped resistance across the filament terminals.

In common with other pentodes the correct anode load should be used if the full value of undistorted output is to be reached.

### TECHNICAL DATA

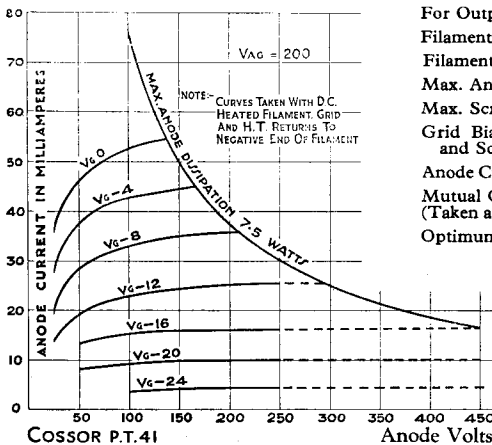

For Output.	
Filament Voltage .. ..	4
Filament Current (Amps.)..	1.0
Max. Anode Volts .. ..	250
Max. Screen Volts .. ..	200
Grid Bias for Max. Anode and Screen Volts ..	-12.5
Anode Current for above (m.a.)	30
Mutual Conductance	3 m.a./v.
(Taken at $V_a$ . 100, $V_{ag}$ . 100, $V_g$ . 0.)	
Optimum Load ..	8,000 ohms

# COSSOR P.T. 41 B.

## 4-VOLT 1 AMP. DIRECTLY HEATED PENTODE

Where large values of undistorted output are required, a high voltage pentode is a very useful valve. One reason for this is the high efficiency of this type of valve from the point of wattage dissipation against output delivered.

The P.T. 41 B. is a directly heated heavy duty valve which takes a rated anode voltage of 400, and has a maximum anode dissipation of 12 watts. In general, a stage of low frequency amplification will be necessary to precede this valve, as an input of approximately 40 volts peak is required for full output.

### TECHNICAL DATA

For Output.

Filament Voltage .. .. .	4
Filament Current (Amps.) .. .. .	1.0
Maximum Anode Volts .. .. .	400
Maximum Screen Volts .. .. .	300
Grid Bias for Maximum Anode and Screen Volts .. .. .	-40
Anode Current for above .. .. .	30 m.a.
Mutual Conductance (at $V_a$ . 100, $V_{g2}$ . 100, $V_{g1}$ . 0.)	2.25 m.a./v.
Optimum Load .. .. .	8,000 ohms

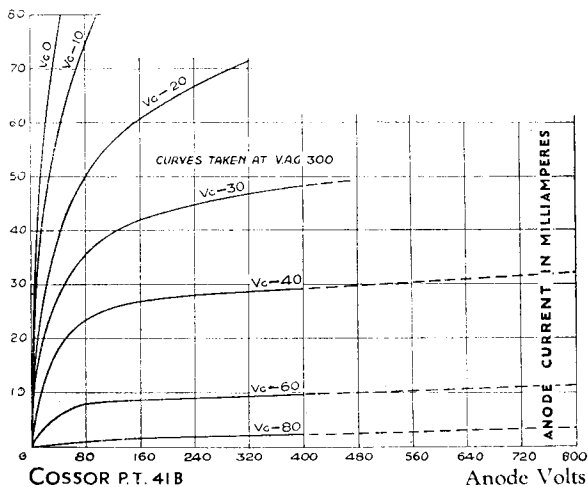

---

---

# COSSOR

## Indirectly Heated Mains Valves

---

---

·2 AMP. SERIES

This series of mains valves has been expressly designed for series-running receivers, either D.C. or Universal (i.e. A.C./D.C.) All valves in the series have a heater current at operating cathode temperature of 0·2 ampere. The heater voltages stated are approximate, and have been chosen to give an adequate cathode wattage referred to the purpose of the valve in question.

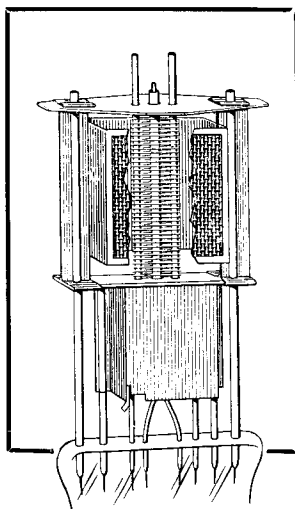

**Cossor**  
13 D.H.A.

# COSSOR 13 V.P.A.

## 13-VOLT ·2 AMP. INDIRECTLY HEATED VARIABLE MU H.F. PENTODE

The Cossor 13 V.P.A. is a variable-mu high frequency screened pentode. It is particularly useful as a high frequency or intermediate frequency amplifier. Its variable-mu characteristic permits of manual volume control by means of variation of grid bias or of the application of automatic volume control.

The suppressor grid is brought out to a separate pin in the seven-pin base type, which makes possible the use of the valve in various special ways, such as for frequency changing. In addition, negative potential applied to this grid will greatly decrease the impedance—a function that may be used in special sets for simultaneously decreasing the gain and flattening the tuning, permitting the most perfect quality from the local station. The valve is also available with five-pin base, where the suppressor grid is connected to cathode.

### TECHNICAL DATA

Heater Voltage (approx) .. .. .	13
Heater Current (Amps.) .. .. .	·2
Maximum Anode Voltage .. .. .	200
Maximum Auxiliary Grid Voltage .. .. .	100
Mutual Conductance at Va. 200, Vag. 100, Vg. 0	1·8 m.a./v.
Grid Voltage (Variable) .. .. .	0 to —30

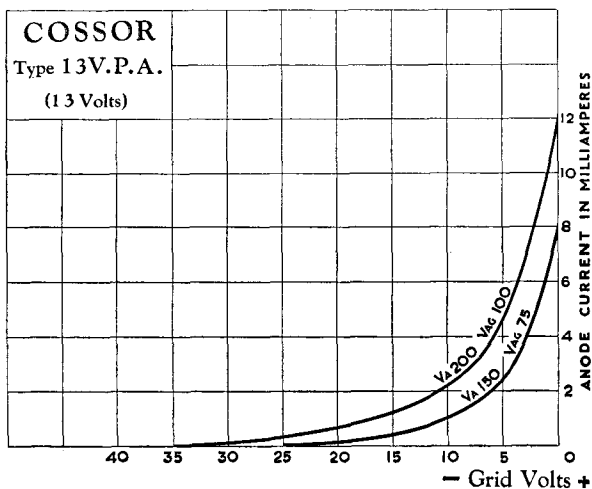

# COSSOR 13 S.P.A.

## 13-VOLT ·2 AMP. INDIRECTLY HEATED H.F. PENTODE

The Cossor 13 S.P.A. has a ·2 amp. heater and is designed for use with others of the series for series running, such as in A.C./D.C. or D.C. receivers. It is a high frequency pentode having general application in two directions: (a) as a high frequency amplifier, (b) as a detector of relatively high sensitivity.

The stage gain under normal conditions for the 13 S.P.A. is rather less than that given by a corresponding A.C. valve. This lower gain is deliberately introduced so that adequate stability can be attained in A.C./D.C. and certain other receivers, where perfect screening is rarely possible. Care should be taken, however, to ensure as good screening as possible, and for the same reason an anode decoupling resistance is usually desirable.

### TECHNICAL DATA

Heater Voltage (approx.) .. .. .	13
Heater Current (Amps.) .. .. .	·2
Maximum Anode Voltage .. .. .	200
Maximum Auxiliary Grid Voltage .. .. .	100
Mutual Conductance at Va. 200, V <sub>g</sub> . 100,	
V <sub>g</sub> - 0 .. .. .	2·5 m.a./v.

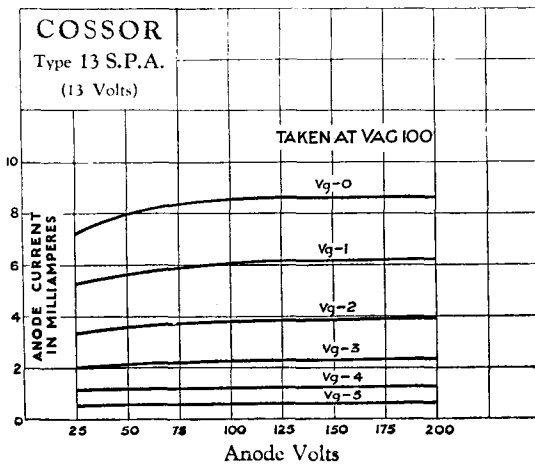

# COSSOR 13 P.G.A.

## 13-VOLT ·2 AMP. INDIRECTLY HEATED PENTAGRID FREQUENCY CHANGER

The Cossor 13 P.G.A. is an indirectly heated mains variable-mu Pentagrid valve and is one of the Cossor series with ·2 amp. heaters intended, among other uses, for series running in A.C./D.C. or D.C. receivers. It is used for frequency changing in a Superheterodyne receiver.

The Cossor Pentagrid provides what is, at the present time, the ideal single valve frequency changer, obviating the external coupling, in the two valve system, for injecting the oscillator output into the detector circuit.

The conversion conductance of the 13 P.G.A. is of such a value as to give satisfactory performance in any of the normal modern A.C./D.C. receivers. The value of this constant is not quite as high as that of the 4-volt, 1-amp. counterpart, 41 M.P.G., as the type of receiver for which the 13 P.G.A. is designed does not readily accommodate too high a value of conversion conductance. The Cossor 13 P.G.A. is distinguished by an inherent freedom from the whistles at various tuning points, that are unavoidable with certain other systems without extremely selective aerial tuning.

### TECHNICAL DATA

Heater Voltage (approx.)	.. .. .	13
Heater Current (Amps.)	.. .. .	·2
Mod. Anode Voltage (Max.)	.. .. .	250
Mod. Screen Voltage (Max.)	.. .. .	100
Mod. Grid Voltage (Variable)	.. .. .	-1·5 to -20
Osc. Anode Voltage (Max.)	.. .. .	200

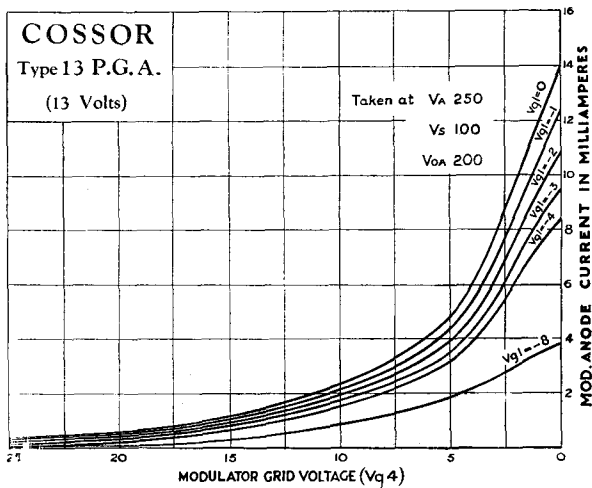



# COSSOR 13 D.H.A.

## 13-VOLT ·2 AMP. INDIRECTLY HEATED DOUBLE DIODE TRIODE

The Cossor 13 D.H.A. is an indirectly heated Double Diode Triode valve in the Cossor ·2 amp. series which may be used in A.C./D.C. or D.C. receivers where the heaters are run in series. This valve is intended for Automatic Volume Control and takes the form of a triode valve with two diodes all sharing the same cathode. The second diode makes it possible to apply delay when using this valve, the extent of which can be regulated as desired by a small negative potential applied to the controlling diode. Used in this way, the sensitivity of the set is not impaired, as A.V.C. will not come into play until the incoming signal reaches a value greater than the delay voltage.

It is to be noted that the Amplification Factor of the Triode portion of the 13 D.H.A. is very large, and the valve is therefore suited for sets in which the preceding H.F. or I.F. gain is only just adequate to provide satisfactory A.V.C.

### TECHNICAL DATA

Heater Voltage (approx.)	.. .. .	13
Heater Current (Amps.)	.. .. .	·2
Maximum Anode Voltage	.. .. .	250
Impedance, at Va. 100, Vg. 0	.. .. .	83,300 ohms
Mutual Conductance, at Va. 100, Vg. 0	.. .. .	1·5 m.a./v.
Amplification Factor, at Va. 100, Vg. 0	.. .. .	125

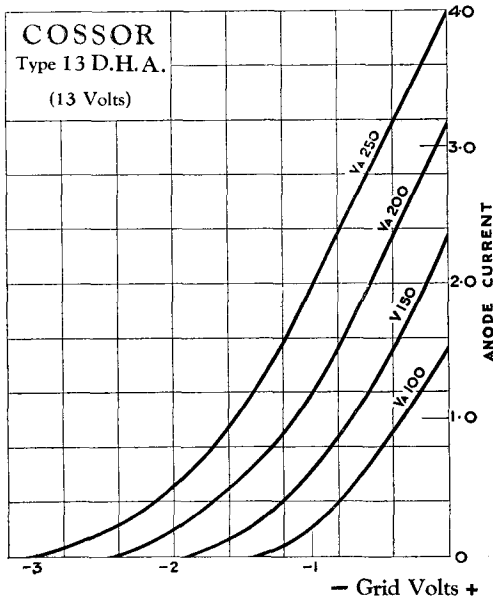

# COSSOR 402 P.

## 40-VOLT ·2 AMP. INDIRECTLY HEATED TRIODE

The Cossor 402 P. is an indirectly heated output Triode of the super power class, designed for series running as in A.C./D.C. receivers. In common with others of the same Cossor range it requires a heater current of ·2 amp., the approximate heater voltage being 40 volts.

The valve is designed for a maximum anode voltage of 200 volts since, in general, no greater voltage can be obtained in the type of receiver for which it is intended, but for other applications this voltage must not be exceeded, while the maximum anode dissipation is 8 watts.

In many circumstances the anode voltage will be of the order of 150 volts and under these conditions the undistorted output available is adequate for domestic purposes.

The Cossor 402 P. has the 7-pin base standard to the range, although only 4-pins are actually used. The control grid is connected to the top cap with a view to avoiding the introduction of A.C. hum which might be present with so sensitive a valve.

### TECHNICAL DATA

Heater Voltage (approx.)	.. ..	40	
Heater Current (Amps.)	.. ..	·2	
Mutual Conductance	.. 7·5 m.a./v.		} At Va 100 Vg 0
Impedance (ohms)	.. .. 1330		
Amplification Factor	.. .. 10		
Maximum Voltage	.. ..	200	
Grid Bias (Anode Volts 150)	.. ..	-9·5 v.	
Anode Current for 150 Anode Volts and -9·5 volts Grid Bias	.. ..	30 m.a.	
Optimum Load	.. .. (ohms)	2,000-2,500	

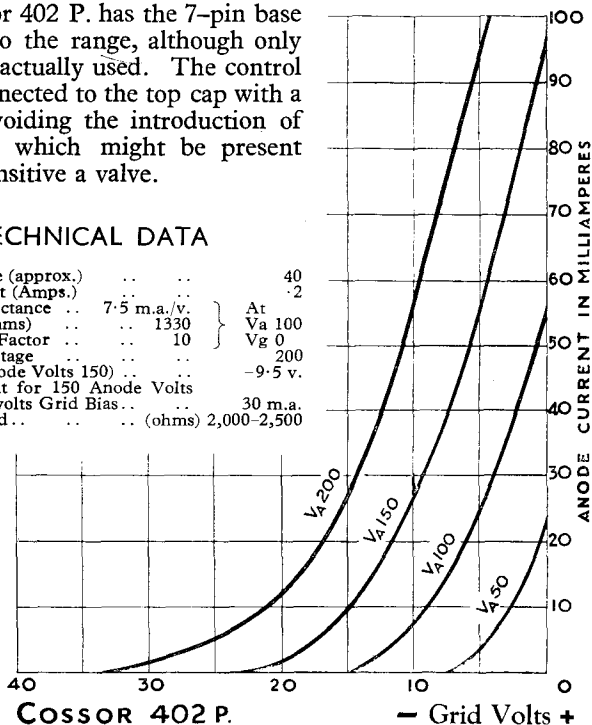

# COSSOR 40 P.P.A.

## 40-VOLT ·2 AMP. INDIRECTLY HEATED OUTPUT PENTODE

The Cossor 40 P.P.A. is a L.F. pentode valve of the indirectly heated cathode type and its undistorted output is adequate for all domestic uses; in common with the others of the range it requires a heater current of ·2 amp., and is designed for series running such as in A.C./D.C. or D.C. receivers.

It will be noted that the valve is designed for a maximum anode and screen voltage of 150 volts owing to the fact that in general, no greater voltage can be obtained in the type of receivers in which it is used. These values must never be exceeded.

### TECHNICAL DATA

Heater Voltage (approx.)	.. .. .	40
Heater Current (Amps.)	.. .. .	·2
Mutual Conductance at Va. 100, Vag. 100, Vg. - 0	.. .. .	4·0 m.a./v.
Maximum Anode Voltage	.. .. .	150
Maximum Screen Voltage	.. .. .	150
Grid Bias (Anode and Screen Volts 150)	.. .. .	-25 v.
Anode Current for 150 Anode and Screen Volts and -25 volts Grid Bias	.. .. .	36 m.a.
Maximum Anode Dissipation	.. .. .	8 watts.
Optimum Load	.. .. .	4000 ohms.

(The Screen Voltage should never exceed the Anode Voltage).

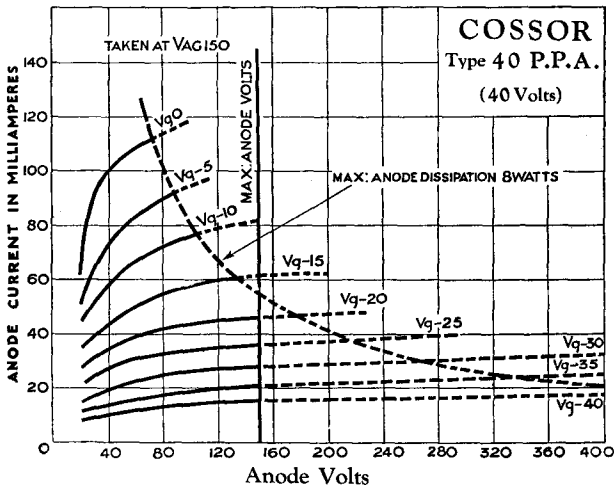

---

# COSSOR

## Indirectly Heated Mains Valves

---

16 VOLTS ·25 AMP. SERIES

The 16-volt series is primarily intended for use in D.C. receivers that are intended for use on D.C. current only.

All the valves in this series have the same heater current, ·25 amp., and consequently are ideal for series running.

These valves will be found useful for D.C. receivers using standard 16-volt D.C. valves, but when a receiver is contemplated for use on either A.C. or D.C., the Cossor ·2 amp. series mains valves will be found more convenient, as the range includes an indirectly heated rectifier especially for this purpose.

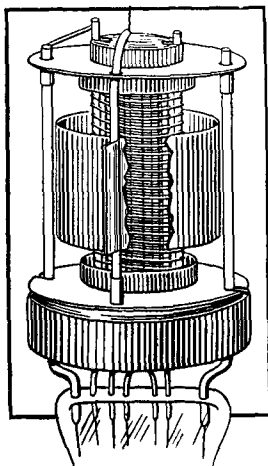

**Cossor**  
**D.S./Pen**  
Anode cut  
away to  
show grids.

# COSSOR D.V.S./PEN.

## 16 VOLT ·25 AMP. INDIRECTLY HEATED VARIABLE MU H.F. PENTODE

The Cossor D.V.S./Pen. is a variable-mu high frequency screened pentode, and generally speaking it may be used in place of any reasonably equivalent screened grid valve, when it will give results equal to or better than previously experienced, according to the coupling used. The suppressor grid is brought out to a separate pin in the seven-pin base type, which makes possible the use of the valve in various special ways, such as for frequency changing; negative potential applied to this grid will greatly decrease the impedance—a function that may be used in special sets for simultaneously decreasing the gain and flattening the tuning, permitting the most perfect quality from the local station. The valve is also available with five-pin base, where the suppressor grid is connected to cathode.

### TECHNICAL DATA

Heater Voltage	..	..	..	..	..	..	..	16
Heater Current (Amps.)	..	..	..	..	..	..	..	·25
Maximum Anode Voltage	..	..	..	..	..	..	..	200
Maximum Auxiliary Grid Voltage	..	..	..	..	..	..	..	100
Mutual Conductance at Va. 200, Vag. 100, Vg. 0	..	..	..	..	..	..	..	3·0 m.a./v.
At Va. 200, Vag. 100, Vg. —1·5	..	..	..	..	..	..	..	2·0 m.a./v.
Negative Grid Voltage (Variable)	..	..	..	..	..	..	..	—1·5 to —20

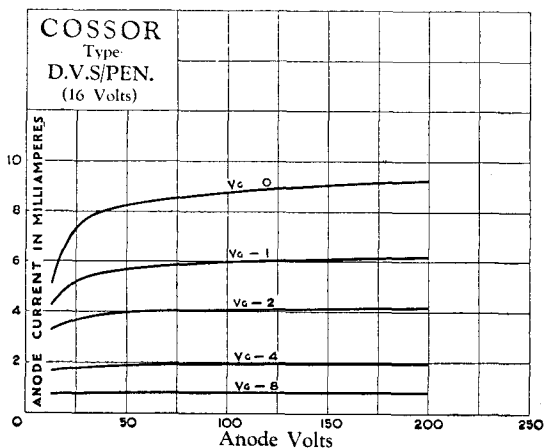

# COSSOR D.V.S.G.

## 16-VOLT ·25 AMP. MAINS INDIRECTLY HEATED VARIABLE MU SCREENED GRID

This valve is a special type of indirectly heated D.C. Mains screened grid valve, having variable-mu characteristics giving important advantages over ordinary types. The valve is so constructed that variation of grid bias permits what is unquestionably the most efficient form of volume control; this system is very convenient and has no adverse effect upon tuning or quality.

As a variation in bias causes a variation in screen current, the screening grid should be fed by some form of potentiometer of correct value to keep the voltage appreciably constant.

### TECHNICAL DATA.

For H.F. Amplification with Bias Volume Control.

Heater Voltage	.. .. .	16
Heater Current (Amps.)	.. .. .	0.25
Maximum Anode Voltage	.. .. .	200
Maximum Screen Voltage	.. .. .	100

Mutual Conductance	2.8 m.a./v. at	{	Va. 200
			Vsg. 80
			Vg. 0
Mutual Conductance	2.5 m.a./v. at	{	Va. 200
			Vsg. 80
			Vg. -1.5

Anode Current at Anode Volts 200, Screen Volts 80 and G.B. — 1.5 .. 7.5 m.a.

Grid Bias (variable) .. — 1.5 to — 35 volts

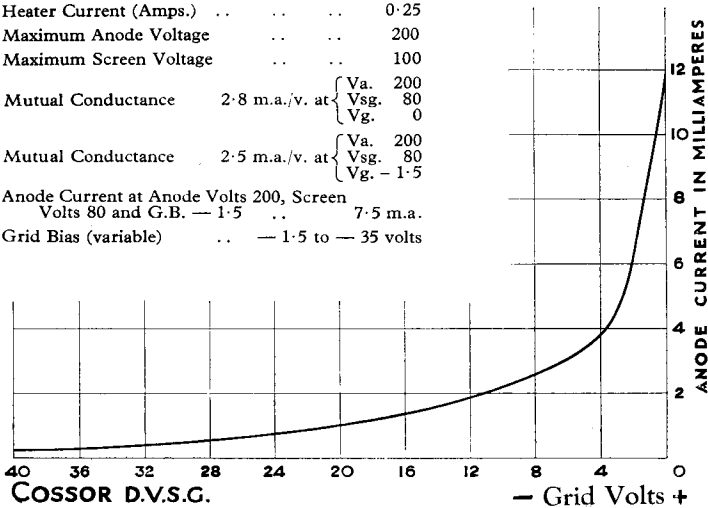

# COSSOR D.S./PEN.

16 VOLT ·25 AMP. INDIRECTLY HEATED  
MAINS H.F. SCREENED PENTODE

This valve is similar to the D.V.S./Pen., but has no variable- $\mu$  characteristics. It may be used in place of an ordinary screen grid valve, or may be used for any of the functions suggested for the D.V.S./Pen. where bias volume control is not required. Another use for this valve is in the detector stage, where it offers possibilities of very high gain combined with very low damping on the preceding tuned circuit. The suppressor grid of this valve is brought out to a separate pin in the case of the seven-pin base type; in the case of the five-pin base type the suppressor grid is connected to cathode. The metallised coating is also brought out to a separate pin, which is often very convenient.

## TECHNICAL DATA

Heater Voltage .. .. .	16
Heater Current (Amps.) .. .. .	·25
Maximum Anode Voltage .. .. .	200
Maximum Auxiliary Grid Voltage .. .. .	100
Mutual Conductance at $V_a$ . 200, $V_{g_2}$ 100, $V_{g_3}$ 0	3·0 m.a./v.
At $V_a$ . 200, $V_{g_2}$ 100, $V_{g_3}$ - 1·5	2·3 m.a./v.

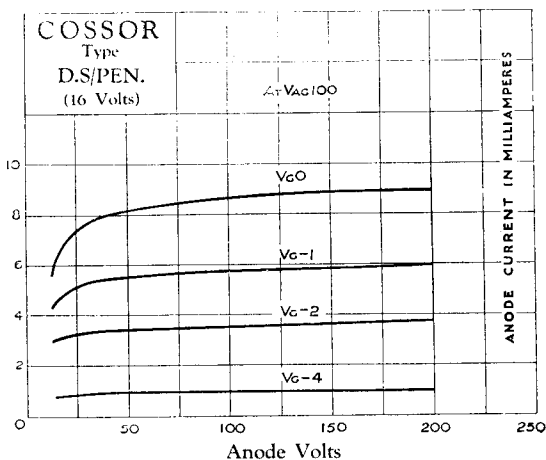

# COSSOR D.D.T. 16

## 16-VOLT ·25 AMP. INDIRECTLY HEATED DOUBLE DIODE TRIODE

The Cossor D.D.T.16 is intended for Automatic Volume Control, and takes the form of a triode valve with two diodes all sharing the same cathode. The second diode makes it possible to apply delay when using this valve, the extent of which can be regulated as desired by a small negative potential applied to the controlling diode. Used in this way, the sensitivity of the set is not impaired, as A.V.C. will not come into play until the incoming signal reaches a value greater than the delay voltage.

### TECHNICAL DATA

Heater Voltage .. .. .	16
Heater Current (Amps.) .. .. .	.25
Maximum Anode Voltage .. .. .	200
Impedance (ohms) at Va. 100, Vg. 0 .. .. .	16,000
Mutual Conductance at Va. 100, Vg. 0 .. .. .	2.5 m.a./v.
Amplification Factor at Va. 100, Vg. 0 .. .. .	40
Bias Resistance (ohms) .. .. .	1,000—1,250

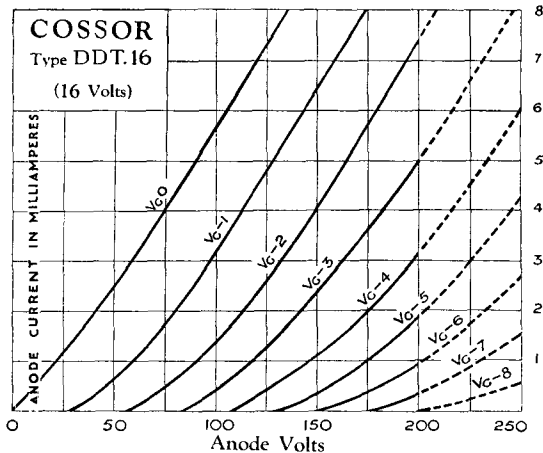



# COSSOR D.H.L.

## 16 VOLT ·25 AMP. INDIRECTLY HEATED MAINS TRIODE

The D.H.L. has relatively low impedance and a high value of mutual conductance. It is therefore highly suitable to work in the detector position of a D.C. mains set, and is capable of handling large input.

As a power grid detector it will be found very sensitive, and will also permit of high stage gain.

It is recommended that if a transformer follows this valve, it should be shunt fed in the usual manner.

### TECHNICAL DATA.

For Detector or H.F.		
Heater Voltage	.. .. .	16
Heater Current (Amps.)	.. .. .	0·25
Maximum Anode Volts	.. .. .	200
Impedance (ohms)	13,000	} at $\left. \begin{array}{l} V_a. 100 \\ V_g. 0 \end{array} \right\}$
Mutual Conductance	.. 4·5 m.a./v.	
Amplification Factor	58	

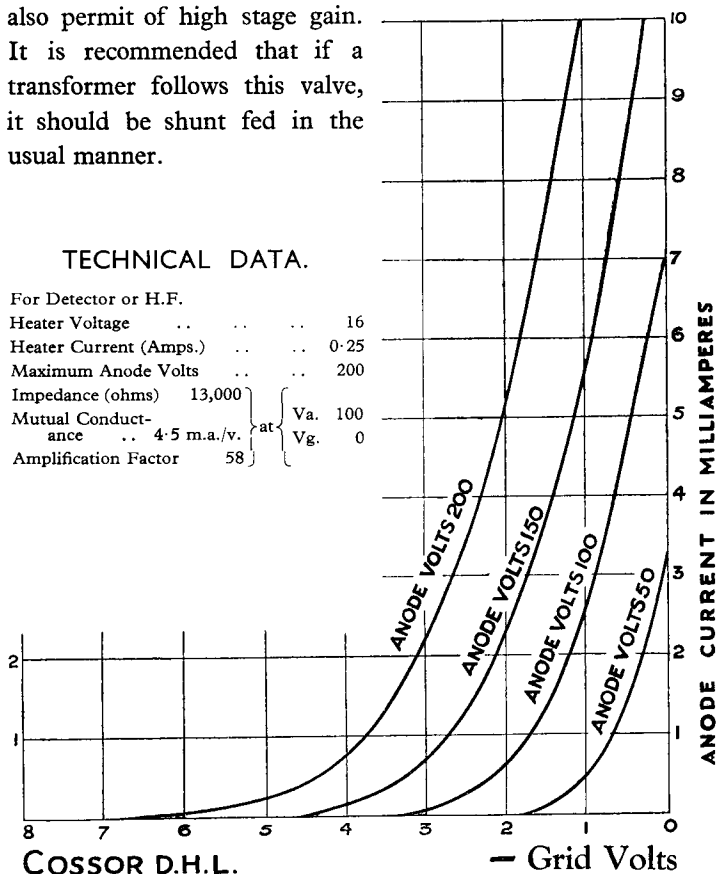

# COSSOR D.P.

## 16-VOLT ·25 AMP. INDIRECTLY HEATED MAINS POWER OUTPUT

The Cossor D.P. is characterised by an exceptionally high value of mutual conductance, which reaches the high figure of 6·0 ; consequently the valve possesses a degree of sensitivity that is very high for a triode valve.

The D.P. is very suitable as a power grid or anode bend detector when the amplification of the preceding stages is such that the voltage developed across the grid-cathode circuit of the detector valve has too high an amplitude to allow a valve of higher impedance to be used and thus avoiding distortion resulting from overload.

### TECHNICAL DATA

For Normal Power Use.

Heater Voltage .. .. .	16
Heater Current (Amps.) .. .	0·25
Impedance (ohms) .. .	2,800
Amplification Factor .. .	17
Mutual Conductance 6·0 m.a./v.	
	} at $V_a$ . 100
	} $V_g$ . 0
Maximum Anode Voltage .. .	200
Grid Bias for 200 Anode Volts ..	-7·5
Anode Current for 200 Anode Volts	
with $-7\frac{1}{2}$ volts Grid Bias ..	25·0 m.a.
Optimum Load .. .	3,500 ohms
Bias Resistance .. .	300 ohms

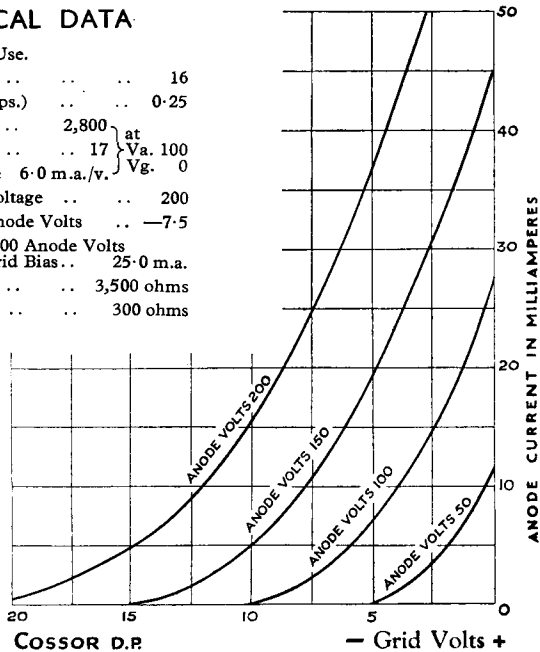

# COSSOR D.P./PEN.

## 16 VOLT ·25 AMP. INDIRECTLY HEATED MAINS OUTPUT PENTODE

For operating moving coil loud speakers, the Cossor D.P./PEN. is supreme among mains indirectly heated D.C. pentodes. It is capable of delivering big, undistorted volume with perfect quality. When occasion arises for using this valve with moving iron loud speakers, a tone corrector should be employed, which is true of any pentode, whether battery or mains operated. The heaters are, of course, intended to be wired in series with a suitable series dropping resistance, so that the current passing through the heater is ·25 amps.

### TECHNICAL DATA

Heater Voltage .. .. .	16	
Heater Current (Amps.) .. .. .	0·25	
Mutual Conductance .. 3·5 m.a./v. } at	$\left\{ \begin{array}{l} V_a. 10 \\ V_{ag}. 100 \\ V_g. 0 \end{array} \right.$	
Maximum Anode Voltage .. .. .		250
Maximum Screen Voltage .. .. .		250
Grid Bias (Anode & Screen Volts 200) ..	-10v.	
Anode Current for 200 Anode Volts and 200 Screen Volts and -10 volts Grid Bias .. .. .	30 m.a.	
Optimum Load .. .. .	10,000 ohms	
Bias Resistance .. .. .	300 ohms	

(The Screen Voltage should never exceed the Anode Voltage).

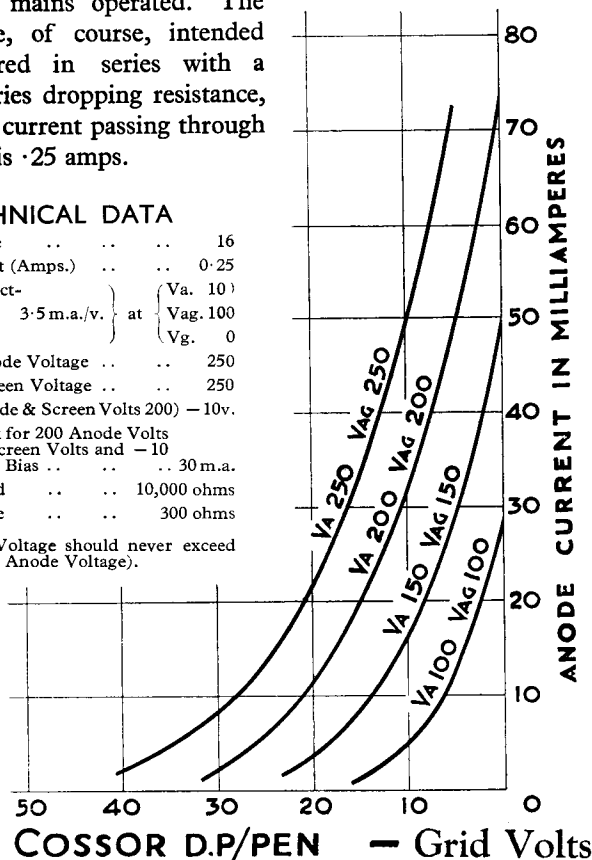

# COSSOR

## Neon Tuning Indicators

Catalogue Nos. 3180 and 3184

The Cossor 3-electrode Neon Tuning Indicator consists of three electrodes—two short and the other long—in an atmosphere of neon.

It may be used in an A.V.C. receiver, where it gives, in the form of a glow spreading up the cathode (long electrode), a visual indication of the correct tuning point, which point is indicated by the maximum height and intensity of the glow.

It is actuated by the rise and fall of the anode currents of A.V.C. controlled variable-mu

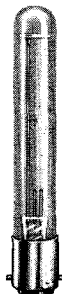

*The Cossor Neon Tuning Indicator Type 3180.*

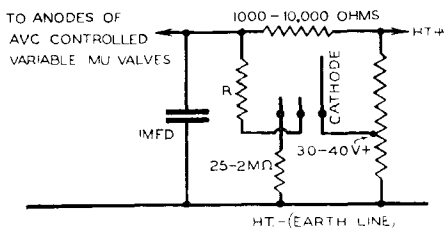

valves. In use, a steady voltage of 145-160 is required to maintain the striking of the tube, and this will rise when the receiver is correctly tuned.

## COSSOR NEON TUBE

VOLTAGE STABILIZER. S.130

The S.130 is a 2-electrode gas-filled tube, adjusted so that a voltage placed across the electrodes causes a discharge through the gas.

It is designed to be placed across the output of any eliminator capable of an output of approximately 130 volts that is required to provide a voltage that does not change appreciably when the current drawn is varied within wide limits. Its chief application is to stabilize the voltage from an eliminator used with a receiver employing a Cossor Class B Output Valve or a Quiescent Push-Pull Output Stage, as both these systems draw an anode current varying widely with the loudness of received signals.

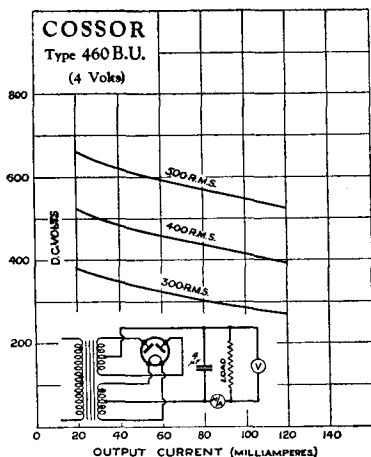

# COSSOR RECTIFIERS

DIRECTLY HEATED  
STANDARD (FULL WAVE)  
**COSSOR 460 B.U.**

The 460 B.U. is a full wave rectifier, similar to the 442 B.U., but giving sufficient voltage for 400-500 volt valves.

### Technical Data.

Filament Voltage .. 4  
 Filament Current (Amps.) .. 2.5  
 Maximum Anode Voltage  
 (R.M.S.) .. 500-0-500  
 Maximum Rectified Current .. 120 m.a

## COSSOR 506 B.U.

The 506 B.U. is a full wave rectifying valve of moderate dissipation, and may be allowed to give up to 60 m.a. with an anode voltage not exceeding 250 R.M.S. on each anode.

### Technical Data.

Filament Voltage .. 4  
 Filament Current (Amps.) .. 1.0  
 Maximum Anode Voltage  
 (R.M.S.) .. 250-0-250  
 Maximum Rectified Current 60 m.a.

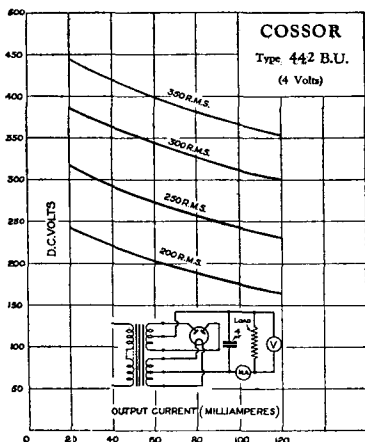
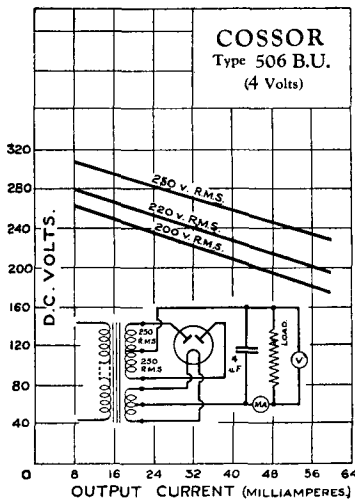

## COSSOR 442 B.U.

The 442 B.U. is a full wave rectifying valve very suitable for sets that require 200 volts at the anode of each valve. 442 B.U. is the rectifier valve in most general use.

### Technical Data.

Filament Voltage .. 4  
 Filament Current (Amps.) .. 2.5  
 Maximum Anode Voltage  
 (R.M.S.) .. 350-0-350  
 Maximum Rectified Current .. 120 m.a

All the above ratings are based on the assumption that a condenser of not less than 4 mfd. is placed across the load.

# COSSOR RECTIFIERS

INDIRECTLY HEATED  
HALF WAVE

## COSSOR 40 S.U.A.

The Cossor 40 S.U.A. valve is a half-wave indirectly heated rectifier intended for series running with the Cossor 13-volt ·2 amp. series of indirectly heated mains valves. This valve is suitable for A.C./D.C. receivers.

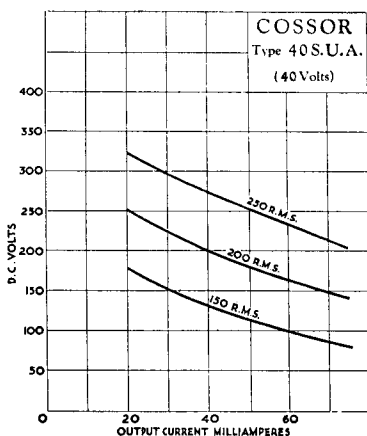

### TECHNICAL DATA

Heater Voltage	.. .. .	40
Heater Current (Amps.)	.. .. .	·2
Maximum Anode Voltage (R.M.S.)	.. .. .	250
Maximum Rectified Current	.. .. .	75 m.a.

The Cossor 40 S.U.A. is an indirectly heated rectifier having a heater current of ·2 amp., and is primarily introduced as a rectifier to be used in conjunction with the Cossor ·2 amp. series of mains valves, either to make possible the use of the receiver on D.C. or A.C. mains or to do away with the mains transformer in the set required for A.C. working only.

It is a single wave rectifier and has a maximum D.C. output of 75 m.a. at 210 volts when a potential of 250 r.m.s. is applied.

This particular valve enjoys the same robust constructional features as the directly heated Cossor rectifiers described on the preceding page.

# COSSOR RECTIFIERS

DIRECTLY HEATED FULL AND HALF WAVE  
(NON-STANDARD TYPES) FOR REPLACEMENT

Type	Rectification	Filament Volts	Filament Amps.	Max. Anode Volts (R.M.S.)	Max. Rectified Current (m.a.)	Max. D.C. Volts at Max. D.C. Current
408 B.U.	Full-wave	4	1	250-0-250	30	270
412 B.U.	" "	4	1	250-0-250	70	250
612 B.U.	" "	6	0·4	250-0-250	50	280
624 B.U.	" "	6	2	500-0-500	60	610
825 B.U.	" "	7·5	2	500-0-500	120	570
44 S.U.	Half-wave	4	0·4	200	20	230
412 S.U.	" "	4	1	250	70	190
660 S.U.	" "	6	4 to 4·5	1000	150	150

# COSSOR H.F. PENTODES

	Heater Voltage	Heater Current	Max. Anode Voltage	Max. Aux. Grid Voltage	Mutual Conductance	Grid Bias (Var.)	Average Anode Current	Bias Resistance
	volts	amps.	volts	volts	m.a./v.	volts	m.a.	ohms
<b>BATTERY OPERATED TYPES</b>								
210 V.P.T.	2.0	0.1	150	80	1.1	0—9	2.9	—
210 S.P.T.	2.0	0.1	150	80	1.3	—	3.0	—
<b>MAINS OPERATED TYPES (Indirectly heated cathodes)</b>								
M.S./PEN.	4.0	1.00	200	100	3.5*	—	—	—
M.V.S./PEN.	4.0	1.00	200	100	3.0*	0—20	—	—
M.S./PEN.-A.	4.0	1.00	200	150	4.0†	—	9	200
D.S./PEN.	16.0	0.25	200	100	3.0*	—	—	—
D.V.S./PEN.	16.0	0.25	200	100	3.0*	0—20	—	—
13 V.P.A.	13.0	0.2	200	100	1.8*	0—30	—	—
13 S.P.A.	13.0	0.2	200	100	2.5*	—	—	—

\* At Va 100, Vag 100, Vg 0.

\* At Va 200, Vag 100, Vg 0.

# COSSOR SCREENED GRID VALVES

	Fil. or Heater Voltage	Fil. or Heater Current	Max. Anode Voltage	Max. Screen Voltage	Working Grid Bias	Average Anode Current	Anode Impedance	Mutual Conductance	Amplification Factor	Bias Resistance
	volts	amps.	volts	volts	volts	m.a.	ohms	m.a./v.		ohms

## BATTERY OPERATED TYPES

215 S.G.	2.0	0.15	150	80	0	2.4	300,000	1.1	330	—
220 S.G.	2.0	0.20	150	80	0	3.1	200,000	1.6	320	—
220 V.S.G.	2.0	0.20	150	80	0—15	2.6†	110,000*	1.6*	—	—
220 V.S.	2.0	0.20	150	80	0—9	1.6†	400,000*	1.6*	—	—
410 S.G.	4.0	0.10	150	80	0	1.2	800,000	1.0	800	—
610 S.G.	6.0	0.10	150	80	0	4.1	200,000	1.0	200	—

\* At Va 150, Vsg 60, Vg 0. † At Va 150, Vsg 60, Vg — 1.5.

## MAINS OPERATED TYPES (Indirectly heated cathodes)

41 M.S.G.	4.0	1.00	200	80	— 1.5	.8	400,000**	2.5**	1,000**	1,500
M.V.S.G.	4.0	1.00	200	100	— 1.5 to — 35	7.8†	200,000†	2.5†	—	—
M.S.G./H.A.	4.0	1.00	200	100	— 1.5	2.1	500,000†	2.0†	1,000†	600
M.S.G./L.A.	4.0	1.00	200	100	— 1.5	5.2	200,000†	3.75†	750†	250
D.V.S.G.	16.0	0.25	200	100	— 1.5 to — 35	7.5†	—	2.5†	—	—

† Va 200, Vsg 80, Vg — 1.5. \*\* At Va 150, Vsg 60, Vg 0.



# COSSOR FREQUENCY CHANGERS & A.V.C. VALVES

	Heater Voltage	Heater Current (amps.)	Max. Anode volts	Max. Screen volts	Average Space Current	Mutual Conductance m.a./v.	Impedance ohms	Amp. Factor	
<b>BATTERY OPERATED FREQUENCY CHANGER</b>									
210 P.G. . . . .	2.0	0.1	150	80	2.0	—	—	—	
<b>MAINS OPERATED FREQUENCY CHANGERS (Indirectly heated cathodes)</b>									
41 M.P.G. . . . .	4.0	1.0	250	100	10.0	—	—	—	
13 P.G.A. . . . .	13.0	0.2	250	100	10.0	—	—	—	
<b>BATTERY OPERATED DIODE</b>									
220 D.D. . . . .	2.0	0.2	—	—	—	—	—	—	
<b>MAINS OPERATED DIODES (Indirectly heated cathodes)</b>									
D.D./PEN. . . . .	4.0	1.0	250	200	—	2.7*	—	—	
D.D.T. . . . .	4.0	1.0	200	—	3.0	2.4†	17,000†	41†	
D.D.4 . . . . .	4.0	0.75	—	—	—	—	—	—	
13 D.H.A. . . . .	13.0	0.2	250	—	0.2	1.5†	83,300†	125†	
D.D.T. 16 . . . .	16.0	0.25	200	—	3.0	2.5†	16,000†	40†	
			* At Va 200, Vs 100, Vg 0.						
<b>BATTERY OPERATED BIGRID</b>									
210 D.G. . . . .	2	0.1	—	—	—	.19	27,000	5.1	
			Taken at Va 100. Vg <sub>2</sub> 0 and Vg <sub>1</sub> to L. T. positive.						
<b>MAINS OPERATED BIGRID</b>									
41 M.D.G. . . . .	4	1.0	200	—	—	0.25	40,000	10	
			Taken at Va 100. Vg <sub>2</sub> 0 and Vg <sub>1</sub> connected to Cathode.						

# COSSOR TRIODES (over 7,000 ohms impedance)

	Fil. Voltage	Heater Current	Max. Anode Voltage	Working Grid Bias	Average Anode Current	Anode Impedance	Mutual Conductance	Amplification Factor	Bias Resistance
	volts	amps.	volts	volts	m.a.	ohms	m.a./v.		ohms
<b>2-VOLT BATTERY TYPES</b>									
210 R.C.	2-0	0-1	150	1-5	0-85	50,000	0-80	40	—
210 H.L.	2-0	0-1	150	3-0	1-60	22,000	1-10	24	—
210 H.F.	2-0	0-1	150	3-0	1-60	15,800	1-50	24	—
210 DET.	2-0	0-1	150	—	—	13,000	1-15	15	—
210 L.F.	2-0	0-1	150	4-5	4-80	10,000	1-40	14	—
410 R.C.	4-0	0-1	150	1-5	0-60	50,000	0-80	40	—
410 H.F.	4-0	0-1	150	3-0	1-20	20,000	1-10	22	—
410 L.F.	4-0	0-1	150	3-0	4-50	10,000	1-70	17	—
610 R.C.	6-0	0-1	150	1-5	0-75	50,000	0-80	40	—
610 H.F.	6-0	0-1	150	3-0	3-00	20,000	1-00	20	—
610 L.F.	6-0	0-1	150	3-0	6-20	7,500	2-00	15	—
<b>MAINS OPERATED TYPES (Indirectly heated cathodes)</b>									
41 M.H.C.	4-0	1-0	200	1-5	3-20	18,000	4-00	72	—
41 M.R.C.	4-0	1-0	200	2-0	2-70	19,000	2-60	50	750
41 M.H.F.	4-0	1-0	200	3-0	3-00	14,500	2-80	41	1000
41 M.H.L.	4-0	1-0	200	3-0	4-00	11,500	4-50	52	750
41 M.L.F.	4-0	1-0	180	5-5	9-00	7,900	1-90	15	600
D.H.L.	16-0	0-25	200	2-0	5-00	13,000	4-50	58	400

# COSSOR OUTPUT TRIODES

	Heater Voltage	Heater Current	Max. Anode Voltage	Working Grid Bias	Average Anode Current	Anode Impedance	Mutual Conductance	Amplification Factor	Bias Resistance	Optimum Load
	volts	amps.	volts	volts	m. a.	ohms	m. a./v.		ohms	ohms
<b>BATTERY OPERATED TYPES</b>										
215 P.	2.0	0.15	150	7.5	10.00	4,000	2.25	9	—	9,000
220 P.	2.0	0.2	150	7.5	11.00	4,000	2.25	9	—	9,000
220 P.A.	2.0	0.2	150	4.5	10.00	4,000	4.00	16	—	9,000
230 X.P.	2.0	0.3	150	18.0	22.00	1,500	3.00	4.5	—	3,500
410 P.	4.0	0.1	150	9.0	11.00	4,000	2.00	8	—	9,000
415 X.P.	4.0	0.15	150	18.0	22.00	1,500	3.00	4.5	—	3,500
425 X.P.	4.0	0.25	150	10.5	20.00	2,000	3.50	7	—	5,000
610 P.	6.0	0.1	150	7.5	11.00	3,500	2.28	8	—	8,000
610 X.P.	6.0	0.1	150	15.0	23.00	2,000	2.50	5	—	4,500
625 P.	6.0	0.25	200	12.0	25.00	2,500	2.80	7	—	6,000
<b>MAINS OPERATED TYPES (Indirectly heated cathodes)</b>										
41 M.P.	4.0	1.0	200	7.5	24.00	2,500	7.50	18.7	320	3,000
41 M.X.P.	4.0	1.0	200	12.5	40.00	1,500	7.50	11.2	300	2,000
402 P.	40.0	0.2	200	9.5	30.00	1,330	7.5	10	320	2,500
*4 X.P.	4.0	1.0	250	22.0	37.00	1,200	4.0	4.8	600	2,800
D.P. . . .	16.0	0.25	200	7.5	25.00	2,800	6.0	17.0	300	3,500

\* Directly heated.

# COSSOR OUTPUT PENTODES

	Fil. or Heater Voltage	Fil. or Heater Current	Max. Anode Voltage	Max. Screen Voltage	Working Grid Bias	Average Anode Current	Anode Impedance	Mutual Conductance	Amplification Factor	Bias Resistance	Optimum Load
	volts	amps.	volts.	volts.	volts	m.a.	ohms	m.a./v.		ohms	ohms
220 P.T.	2-0	0-2	150	150	9-0	19-0	—	2-5	—	—	7,500
220 H.P.T.	2-0	0-2	150	150	4-5	8-0	—	2-5	—	—	17,000
230 P.T.	2-0	0-3	150	150	15-0	14-0	—	2-0	—	—	10,000
410 P.T.	4-0	0-10	150	150	9-0	17-0	—	2-5	—	—	7,500
415 P.T.	4-0	0-15	150	150	15-0	14-0	—	2-0	—	—	10,000
615 P.T.	6-0	0-15	150	150	15-0	14-0	—	2-0	—	—	10,000

## BATTERY OPERATED TYPES

220 P.T.	2-0	0-2	150	150	9-0	19-0	—	2-5	—	—	7,500
220 H.P.T.	2-0	0-2	150	150	4-5	8-0	—	2-5	—	—	17,000
230 P.T.	2-0	0-3	150	150	15-0	14-0	—	2-0	—	—	10,000
410 P.T.	4-0	0-10	150	150	9-0	17-0	—	2-5	—	—	7,500
415 P.T.	4-0	0-15	150	150	15-0	14-0	—	2-0	—	—	10,000
615 P.T.	6-0	0-15	150	150	15-0	14-0	—	2-0	—	—	10,000

## MAINS OPERATED TYPES (Indirectly Heated Cathodes)

M.P./PEN.	4-0	1-0	250	250	16-0	30-0	—	3-5*	—	450	10,000
42 M.P./PEN.	4-0	2-0	250	250	5-5	32-0	—	7-0*	—	140	8,000
D.P./PEN.	16-0	0-25	250	250	10-0	30-0	—	3-5*	—	300	10,000
40 P.P.A.	40-0	.2	150	150	25-0	36-0	—	4-0	—	—	4,000

## MAINS OPERATED TYPES (Directly heated)

P.T. 41	4-0	1-0	250	200	12-5	30-0	—	3-0*	—	350	8,000
P.T. 41B.	4-0	1-0	400	300	40-0	30-0	—	2-25*	—	1,200	8,000

\* Va 100, Vag 100, Vg 0.

# COSSOR CLASS "B" VALVES

	Fil. Voltage	Fil. Current	Max. Anode Voltage	Max. An. Current Swing	Max. Peak Applied Signal	Average Anode Current	Static Anode Current	Anode to Anode Load at 90 v. at 120 v.
	volts	amps.	volts	m.a.	volts	m.a.	m.a.	ohms ohms
220 B .. ..	2-0	0-2	120	35	40	6	1-25*	20,000 12,000
240 B. .. ..	2-0	0-4	150	50	40	8-5	1-50*	10,000 8,000

\* At Va 100, Vg 0.

# COSSOR RECTIFIERS

	Filament Voltage	Filament Current	A.C. Volts per anode RMS	Max. D.C. Volts developed at Max. D.C. Current	Max. D.C. Output m.a.	Type of Rectification
<b>STANDARD TYPES</b>						
506 B.U. .. ..	4-0	1-0	250	230	60	Full wave
442 B.U. .. ..	4-0	2-5	350	350	120	" "
460 B.U. .. ..	4-0	2-5	500	520	120	" "
40 S.U.A. .. ..	40-0	0-2	250	—	75	Half wave
<b>NON-STANDARD TYPES (available for replacement purposes only)</b>						
44 S.U. .. ..	4-0	0-4	200	230	20	Half wave
412 S.U. .. ..	4-0	1-0	250	190	70	" "
660 S.U. .. ..	6-0	4/4-5	1,000	1,500	150	" "
408 B.U. .. ..	4-0	1-0	250	270	30	Full wave
412 B.U. .. ..	4-0	1-0	250	250	70	" "
612 B.U. .. ..	6-0	0-4	250	280	50	" "
624 B.U. .. ..	6-0	2-0	500	610	60	" "
825 B.U. .. ..	7-5	2-0	500	570	120	" "

# **COSSOR VALVE EQUIVALENTS**

---

**While the characteristics of equivalents given are not always identical, the Cossor types recommended are based on Service Tests and Retailer's reports on actual performance in Receivers**

# COSSOR VALVE EQUIVALENTS

## BATTERY VALVE Equivalents.

Cossor	Marconi and Osram	Mazda	Mullard
215 S.G.	S.21, S.23	S.G.215	P.M. 12
220 S.G.	S.22, S.24	S.215 B.	P.M. 12A.
220 V.S.G.	V.S.2	—	P.M. 12V.
220 V.S.	V.S.24	S.215 V.M.	P.M. 12M.
210 S.P.T.	—	S.P.215	S.P.2
210 V.P.T.	V.P.21	V.P.215	V.P.2
210 P.G.	X.21	—	—
210 D.G.	D.G.2	—	P.M.1 D.G.
220 D.D.	—	—	—
210 R.C.	H.2, H.210	H.2, H.210	P.M. 1A
210 H.L.	H.L.210	H.L.2	P.M. 1H.F.
210 H.F.	H.L.2	H.L.210	P.M. 1H.L.
210 DET.	L.210	—	P.M. 2D.X.
210 L.F.	L.21	L.2	P.M. 1L.F.
215 P.	P.215	P.215	—
220 P.	—	—	P.M. 2
220 P.A.	L.P.2	P.220	P.M. 2A.
230 X.P.	P.2, P.240	P.220A., P.240	P.M. 202, P.M. 252
220 H.P.T.	P.T.2	Pen. 220	P.M. 22A.
220 P.T.	—	Pen. 220A.	P.M. 22
230 P.T.	P.T. 240	Pen. 230	—
220 B.	—	P.D.220	P.M. 2B.
240 B.	—	—	—

## RECTIFIER VALVE Equivalents.

Cossor	Marconi & Osram	Mazda	Mullard	Philips
506 B.U.	U.10	U.U.2	D.W.2	1821, 506K.
442 B.U.	U.12	U.U.120/350	D.W.3	1807
460 B.U.	U.14	U.U.120/500	D.W.4	1561
40 S.U.A.	—	U.4020	—	—
44 S.U.	—	—	—	—
412 S.U.	—	U.30/250	D.U.10	373
408 B.U.	—	—	D.W.1	—
612 B.U.	—	—	—	—
412 B.U.	U.9	—	D.U.2	1801
624 B.U.	—	—	—	—
825 B.U.	U.8	—	D.W.30	—

### A.C. MAINS VALVE Equivalents

Cossor	Marconi & Osram	Mazda	Mullard
M.S.G./H.A.	M.S.4	A.C./S.G.	S.4 V.A.
41 M.S.G.	—	—	S.4 V.
M.S.G./L.A.	M.S.4 B.	—	S.4 V.B.
M.V.S.G.	V.M.S.4, V.M.S.4 B.	A.C./S.1 V.M.	M.M.4 V.
M.S./PEN.	M.S.P.4	A.C./S.2 Pen.	S.P.4
M.S./PEN-A.	—	—	—
M.V.S./PEN.	V.M.P.4	A.C./V.P.1	V.P.4
41 M.P.G.	M.X.40	—	—
41 M.D.G.	—	—	A.C./D.G.
41 M.R.C.	—	—	484 V.
41 M.H.	M.H.41	A.C.2/H.L.	904 V.
41 M.H.F.	M.H.4	A.C./H.L.	354 V.
41 M.H.L.	M.H.4	A.C./H.L.	354 V.
41 M.L.F.	M.H.L.4	—	244 V, 164 V.
DD.4	—	V.914	2D. 4A.
D.D.T.	M.H.D.4	A.C./HL.DD.	T.D.D.4
D.D./PEN.	—	—	—
41 M.P.	M.L.4	A.C./P.	104 V.
41 M.X.P.	—	A.C./P.1	054 V.
M.P./PEN.	M.P.T.4	A.C./Pen.	Pen. 4 V., Pen. 4 V.A.
42 M.P./PEN.	M.P.T.41, N.41	A.C.2/Pen.	Pen. 4 V.B.
4 X.P.	P.X.4	P.P.3/250	A.C. 044
P.T. 41	P.T.4	—	P.M. 24M.
P.T. 41 B.	P.T.16	—	P.M. 24 B.

### D.C. MAINS VALVE Equivalents

Cossor	Marconi & Osram	Mazda	Mullard
D.V.S.G.	V.D.S., V.D.S.B.	—	—
D.S./PEN.	D.S.P. 1	—	—
D.V.S./PEN.	V.D.P. 1	—	—
D.D.T.16	D.H.D.	—	—
D.H.L.	D.H.	—	—
D.P.	D.L.	—	—
D.P./PEN.	D.P.T.	—	—

### A.C./D.C. MAINS VALVE Equivalents

Cossor	Mazda	Mullard
13 S.P.A.	S.P. 1320	S.P. 13C.
13 V.P.A.	V.P. 1320	V.P. 13C.
13 P.G.A.	—	—
13 D.H.A.	H.L./D.D. 1320	T.D.D. 13.C
402 P.	—	—
40 P.P.A.	—	—
40 S.U.A.	U. 4020	—



# COSSOR VALVES

for

## COSSOR KITS AND RECEIVERS

TO ENSURE MAXIMUM RESULTS THE  
SPECIFIED TYPES MUST BE USED

*Figures in brackets so—(5)—indicate the number of pins in valve base.*

### COSSOR KITS—BATTERY

Melody Maker, 1927-8 .. ..	210 RC, 210 HF, 220 P
B.K. 229 Melody Maker, 1928-9 .. ..	215 SG, 210 RC, 215 P
B.K.4 Melody Maker, 1929-30 .. ..	215 SG, 210 RC, 220 P
B.K.631, 4-valve Battery Kit .. ..	215 SG, 210 RC, 210 LF, 220 P
B.K.531 Empire Melody Maker .. ..	215 SG, 210 RC, 220 P
Model 234 Empire Melody Maker .. ..	*220 SG, 210 HL, 220 P
Models 333/4/5 Melody Maker .. ..	*220 VSG, *210 HL, 220 P
Model 340 Melody Maker .. ..	220 VS, 210 HL (or 210 HF), 220 P
Models 341/2 Melody Maker .. ..	220 VS, 210 HL (or 210 HF), 220 HPT (5)
Model 344 Melody Maker .. ..	220 VS, 210 HL (or 210 HF), †215 P, 220 B
Model 352 Melody Maker .. ..	*220 VS, 210 HL (or 210 HF), 220 HPT (5)
Model 362 Melody Maker .. ..	*210 VPT (7), 210 SPT (7), 220 HPT (5)

### COSSOR RECEIVERS—BATTERY

2-valve Battery Receiver .. ..	210 HF, 220 PT (4)
3-valve S.G. Receiver .. ..	215 SG, 210 RC, 220 PT (4)
Model 731 Commander .. ..	215 SG, 215 SG, 210 HF, 220 P
Model 221, 2-valve .. ..	210 HL, 220 P
Model 732, 4-valve .. ..	*220 VSG, *220 VSG, *210 HL, 220 P
Model 732M, 4-valve .. ..	*220 VSG, *220 VSG, 210 HL, 220 PT (5)
Models 322/323, 2-valve .. ..	210 HL (or 210 HF), 220 P
Model 3456 Console .. ..	220 VS, 210 HL (or 210 HF), †215 P, 220 B
Model 735 Console .. ..	*220 VS, 220* VS, *210 HL (or *210 HF) †210 LF, 220 B
Models 634 and 634A Superhet .. ..	220 PT (5), *220 VS, *210 HL (or *210 HF), †210 LF, 220 B
Model 350, Table Model .. ..	*220 VS, 210 HL (or 210 HF), 220 P
Model 353, Table Model .. ..	*220 VS, 210 SPT (7), 220 HPT (5)
Model 435B, Table Model .. ..	*220 VS, 210 SPT (7), †215 P, 220 B
Model 3455 Console .. ..	*220 VS, 210 SPT (7), 220 HPT (5)
Model 355 Console .. ..	*220 VS, 210 SPT (7), 220 HPT (5)
Model 360, Table Model .. ..	*210 VPT (7), 210 SPT (7), 220 P
Model 363, Table Model .. ..	*210 VPT (7), 210 SPT (7), 220 HPT (5)
Model 436B, Table Model .. ..	*210 VPT (7), 210 SPT (7), †220 PA, 220 B
Model 366A, Superhet .. ..	*210 PG, *210 VPT (7), 220 DD, 220 HPT (5)
Model 3535 Console .. ..	*220 VS, 210 SPT, 220 HPT. (5)

\* Metallised.

† Driver Valve.

COSSOR RECEIVERS continued.

**COSSOR KITS—A.C. MAINS**

M.K.530 Melody Maker, 1929-30 ..	41 MSG, 41 MRC, 410 P, 612 BU (or 412 BU)
Model 235 Empire Melody Maker ..	*MSG/LA, *41 MH, 41 MP, 442 BU
Models 336/7/8 Melody Maker ..	*MVSG, *41 MH, 41 MP, 442 BU
Model 347 Melody Maker ..	*MVSG, *41 MH, 41 MP, 442 BU
Model 357 Melody Maker ..	*MVSG, *MS/Pen (7), 41 MP, 442 BU
Model 361 Melody Maker ..	*MVS/Pen (7), *MS/Pen (7), 41 MP, 442 BU

**COSSOR RECEIVERS—MAINS**

2-valve A.C. .. .. .	41 MRC, 410 P, 44 SU
2-valve A.C. All In .. .. .	41 MRC, 410 P, 44 SU
Model M.R.331, 3-valve A.C. ..	41 MH, 41 MHL, 415 XP, 44 SU (or 412 BU)
3-valve S.G., A.C. .. .. .	41 MSG, 41 MRC, 410 P, 612 BU (or 412 BU)
Model M.R.130, 2-valve A.C. ..	41 MRC, 415 PT (4), 44 SU
Model M.R.133, 2-valve Oak Cabinet	41 MRC, 415 PT (4), 44 SU
Model M.R.230, 2-valve A.C. ..	41 MRC, 415 PT (4), 44 SU
Model 233, 2-valve A.C. .. ..	*41 MHL, 41 MP, 442 BU
Models 222 and 222A, 2-valve A.C.	*41 MH, 41 MXP, 442 BU
Models 533 and 533A, 4-valve A.C.	*MVSG, *MVSG, *41 MH, 41 MXP, 442 BU
Model 833 Super-Selective .. ..	*41 MSG, *41 MSG, *41 MSG, *41 MDG, MSG/HA, 41 MXP, 442 BU, 506 BU
Model 3468 Console A.C. .. ..	*MVSG, *41 MH, 41 MP, 442 BU
Model 3469 Console D.C. .. ..	*DVSG, *DHL, DP
Model 435 A.C. .. .. .	*MVSG, *MS/Pen (7), MP/Pen (7), 442 BU
Model 635 Superhet .. .. .	*MVS/Pen (7), 41 MP, *MVS/Pen (7), MSG/HA, MP/Pen (5), 442 BU
Model 635 (L) .. .. .	*MVS/Pen (7), 41 MP, *MVS/Pen (7), *MS/Pen (7), MP/Pen (5), 442 BU
Model 358, Table Model .. .. .	*MVSG, *MS/Pen (7), 41 MP, 442 BU
Model 435A, Table Model .. ..	*MVSG, *MS/Pen (7), PT 41, 442 BU
Model 356, Console .. .. .	*MVSG, *MS/Pen (7), PT 41, 442 BU
Model 536, Radiogramophone	*MVSG, *MS/Pen (7), PT 41, 442 BU
Model 535, Superheterodyne ..	*41 MPG, *MVS/Pen (7), DD4, 42 MP/Pen, 442 BU
Model 368, Table Model .. .. .	*MVS/Pen (7), *MS/Pen (7), 41 MP, 442 BU
Models 369 and 369A, Universal ..	*13 VPA, 13 SPA, 402 P, 40 SUA
Model 367, Table Model .. .. .	*MVS/Pen (7), *MS/Pen (7), PT 41, 442 BU
Model 364, Superheterodyne ..	*41 MPG, *MVS/Pen (7), DD4, 42 MP/Pen, 442 BU
Model 365, Superheterodyne ..	*41 MPG, *MVS/Pen (7), *DDT, 4 XP, 442 BU
Model 736, Table Radiogram ..	*41 MPG, *MVS/Pen (7), DD4, 42 MP/Pen, 442 BU

\* Metallised.

# COSSOR VALVES

## Recommended for COMMERCIAL RECEIVERS

### SPECIAL NOTE.

Valves are marked with an asterisk whenever it is definitely known that a metallised valve should be used. There may be one or two instances where a valve not so marked should be metallised. When replacing a metallised valve by a type recommended below the replacement should also be metallised.

In cases of Receivers other than those listed herein our Technical Service Department will gladly give every possible assistance in selecting the most suitable valves to ensure complete satisfaction to the user.

SET.

COSSOR VALVES.

### Aeonic Radio, Ltd.

Aeonic Portable .. .. 210 LF, 210 LF, 210 Det., 210 R.C., 215 P

### Aerodyne Radio

Swift .. .. 210 HF, 210 HF, 220 PA  
 Kestrel .. .. 210 HF, 210 LF, 220 B  
 Finch .. .. 220 SG, 210 HF, 220 PA  
 Eagle .. .. 215 SG, 210 HF, 210 HF, 220 HPT  
 Swan .. .. MVSG, 41 MHL, MP/Pen  
 Falcon .. .. 220 SG, 220 VS, 210 HF, 215 P, 240 B  
 Raven .. .. \*210 HF, 210 LF, 220 PA  
 Cardinal .. .. \*41 MPG, \*MVS/Pen, \*DDT, MP/Pen  
 Blackbird .. .. \*220 VS, \*210 HF, 210 LF, 220 B  
 Silver King .. .. MS/Pen, MVS/Pen, DDT, MP/Pen  
 Aerodyne Hawk .. .. 220 VS, 210 HF, 220 PT (2)  
 Aerodyne Mains 2 .. .. 41 MH, MP/Pen  
 V.M.U. Battery 3 S.G. .. .. 220 VS, 210 HF, 230 XP  
 Table Radiogram .. .. MVSG, 41 MH, MP/Pen  
 Pedestal de Luxe .. .. 220 VS, 210 HF, 230 XP  
 Superhet Cardinal .. .. MS/Pen, MVS/Pen, DDT, MP/Pen  
 Wren .. .. \*210 VPT, 210 HF, 220 PA  
 Wren De Luxe .. .. \*210 VPT, 210 HF, 220 HPT  
 Drake .. .. \*MVS/Pen, \*MS/Pen, MP/Pen  
 Swallow .. .. ———, \*MVS/Pen, \*DDT, MP/Pen  
 Merlin .. .. \*210 VPT, \*210 HF, 220 HPT  
 Robin .. .. \*MS/Pen, MP/Pen  
 A.C. Kingfisher .. .. \*MVS/Pen, \*MS/Pen, MP/Pen  
 Thrush .. .. \*210 VPT, \*210 HF, 220 HPT  
 Nightingale .. .. \*210 VPT, 210 HF, 220 HPT  
 Silverwing .. .. ———, \*MVS/Pen, \*DD4, 42 MP/Pen

### Alba (A. J. Balcombe, Ltd.)

Alba Tudor Radiogram .. .. \*210 SPT, \*210 HF, 220 HPT  
 Alba 21 .. .. \*210 SPT, \*210 HF, 220 HPT  
 Alba 22 .. .. 215 SG, 210 HF, 220 HPT  
 Alba 23 .. .. 220 HPT, \*220 VS, \*210 HF, 210 LF, 220 B  
 Alba 33 .. .. 215 SG, 210 HF, 220 HPT  
 Alba 34 .. .. 220 HPT, \*220 VS, \*210 HF, 210 LF, 220 B  
 Alba 43 .. .. \*210 SPT, \*210 HF, 220 HPT  
 Alba 44 Radiogram .. .. 215 SG, 210 HF, 220 HPT  
 Alba 45 Radiogram .. .. 220 HPT, \*220 VS, \*210 HF, 210 LF, 220 B  
 Alba 50 .. .. MVSG, MSG/LA, PT 41, 506 BU

**Alba (A. J. Balcombe, Ltd.)—contd.**

Alba 52 .. .. .	*MVS/Pen, MS/Pen, PT 41, 442 BU
Alba 54 A.C. .. .. .	MS/Pen, *MVS/Pen, *MSG/LA, PT 41
Alba 55 .. .. .	MSG/LA, 41 MH, MP/Pen
Alba 56 .. .. .	MS/Pen, *MVS/Pen, MSG/LA, PT 41
Alba 66 A.C. .. .. .	MSG/LA, 41 MH, MP/Pen, 506 BU
Alba 67 A.C. .. .. .	MS/Pen, *MVS/Pen, MSG/LA, PT 41
Alba 70 A.C. 3 Radiogram .. .. .	MVSG, MSG/LA, PT 41, 506 BU
Alba 72 .. .. .	*MVS/Pen, MS/Pen, PT 41, 442 BU
Alba 77 A.C. .. .. .	MSG/LA, 41 MH, MP/Pen, 506 BU
Alba 78 .. .. .	MS/Pen, *MVS/Pen, MSG/LA, PT 41
Alba 88 A.C. .. .. .	MSG/LA, 41 MH, MP/Pen
Alba 222 .. .. .	*220 VS, *210 HF, 210 LF, 220 B
Alba 444 .. .. .	*220 VS, *210 HF, 210 LF, 220 B
Alba Q.A.V.C. Superhet .. .. .	*MVS/Pen, MS/Pen, *MVS/Pen, DDT, 41 MRC MP/Pen
Alba 57/68 .. .. .	————, ———, *DD4, ———, MP/Pen
Alba 79 (A.C.5) .. .. .	————, ———, *DD4, ———, MP/Pen
Alba 212 and 201 .. .. .	*210 SPT, *210 HF, 220 HPT
Alba 501 A.C. .. .. .	————, *MS/Pen, 42 MP/Pen
Alba 701 A.C. .. .. .	————, *MS/Pen, 42 MP/Pen

**Amplion (1932) Ltd.**

Amplion Suitcase Portable .. .. .	215 SG, 215 SG, 210 HL, 230 PT
Amplion 6-valve Mains .. .. .	MSG/LA, MSG/LA, 41 MHL, 625 P (2), 442 BU
Radiolux Table Model .. .. .	————, *41 MPG, *MVS/Pen, MP/Pen
Radiolux Radiogram .. .. .	————, *41 MPG, *MVS/Pen, MP/Pen
Radiolux Autogram .. .. .	————, *41 MPG, *MVS/Pen, MP/Pen

**Beethoven Radio Ltd.**

Q.C.R. Attache Portable .. .. .	210 HL, 210 HL, 210 HL, 210 LF, 215 P
Self Tuning Portable .. .. .	210 HL, 210 HL, 210 HF, 210 LF, 215 P
S.G. Portable .. .. .	215 SG, 210 HF, 210 LF, 215 P
All-Electric Twin S.G.3 .. .. .	MSG/HA, MSG/HA, MP/Pen
S.G. 4 Battery Transportable .. .. .	215 SG, 210 HF, 210 HF, 220 HPT
S.G. Major Portable .. .. .	215 SG, 210 HF, 210 HF, 220 HPT
S.G. Minor Portable .. .. .	215 SG, 210 HF, 210 HF, 220 P
All-Electric Superhet .. .. .	————, MVS/Pen, DD4, MVS/Pen, MP/Pen
Model 54 M/C .. .. .	*210 VPT, *210 HF, *210 HF, 220 HPT
Model 53 S.G.3 M/C .. .. .	*210 VPT, *210 HF, 220 HPT
Model 56 .. .. .	————, *MVS/Pen, *DD4, ———, MP/Pen
Model P.85 .. .. .	*220 VS, *210 HF, *210 HF, 220 HPT
Model P.75 .. .. .	*220 VS, *210 HF, *210 HF, 220 PA

**Botolph Radio, Ltd.**

Quest Battery 3 .. .. .	215 SG, *210 HF, 220 P
Botolph 5 .. .. .	210 HF, 210 HF, *210 HF, 210 HF, 220 P
Imperator 4 (1933) .. .. .	MP/Pen, MVSG, *MSG/LA, MP/Pen
Imperator 4 (1934) .. .. .	MS/Pen, MVSG, MVSG, MP/Pen
Imperator 4 Radiogram .. .. .	MS/Pen, MVSG, MVSG, MP/Pen
The Chummy .. .. .	210 HF, 210 HF, 220 P
Botolph Car Set .. .. .	MS/Pen, MVSG, MVSG, MP/Pen
Battery 4 .. .. .	215 SG, *210 HF, 210 HF, 220 P
Botolph Clock Set .. .. .	MS/Pen, MVSG, MVSG, MP/Pen

**British Blue Spot**

Blue Spot 4-valve Battery .. .. .	220 VSG, 210 HF, 215 P, 220 B
-----------------------------------	-------------------------------

**British Clarion Co.**

Clarion Battery 3 .. .. .	*210 HL, 210 LF, 220 P
Clarion S.G. Mains 4 .. .. .	MSG/LA, *41 MH, MP/Pen
Clarion 5-valve Mains Sup'het .. .. .	*MVS/Pen, MS/Pen, DDT, MP/Pen
Clarion Bivox 5-valve Mains .. .. .	————, ———, ———, ———, ———, ———
Superhet .. .. .	*MVS/Pen, MS/Pen, DDT, MP/Pen
Clarion 2 S.G. All-Electric .. .. .	*MVSG, *MVSG, *41 MH, MP/Pen
Clarion Bivox Junior All-Electric .. .. .	*MVSG, *MVSG, *41 MH, MP/Pen
Clarion All-Electric Radiogram .. .. .	*MVSG, *MVSG, *41 MH, MP/Pen
Clarion Superhet Radiogram .. .. .	*MVS/Pen, MS/Pen, DDT, MP/Pen

**Brownie Wireless Co.**

Baby Grand 2-valve Battery .. .. .	210 HF, 215 P
Baby Grand Mains .. .. .	41 MHL, 415 PT
Dominion Console .. .. .	210 HF, 210 LF, 220 P
Dominion Grand (Battery) .. .. .	215 SG, 210 HF, 230 PT
Dominion Grand (Mains) .. .. .	MSG/LA, 41 MHL, 415 PT

**Burgoyne Wireless Ltd.**

Popular 3	210 HF, 210 LF, 215 P
Popular 3 De Luxe	210 HF, 210 LF, 220 PT
Olympic 3	*210 HF, 210 LF, 220 P
Portable 5	210 HL, 210 HF, 210 HF, 210 LF, 220 P
Class B 3	210 HL, 210 LF, 220 B
Dreadnought 3	220 SG, 210 LF, 220 HPT
Battery Superhet	*210 SPT, *210 VPT, *210 HL, *210 Det, 220 B
Class B De Luxe	*210 HF, 210 LF, 220 B
Two Pentode 3	*210 SPT, *210 Det, 220 HPT
S.G. Portable 4	*210 SPT, *210 HF, 210 Det, 220 HPT
Improved Portable 5	210 HL, 210 HF, *210 HF, 210 LF, 220 P
2-F Comet	*210 SPT, *210 HF, 220 PT

**Burndep, Ltd.**

Ethophone S.G. 3	215 SG, 210 Det, 230 PT
Screened Portable	215 SG, 210 RC, 210 HL, 230 XP
Super Screened Portable	215 SG, 210 RC, 210 HL, 230 XP
A.C. Merrymaker	41 MH, 41 MP
Supermains Merrymaker	41 MH, 41 MP
Wandering Minstrel	MVSG, 41 MH, MP/Pen
Superhet 4	MS/Pen, *MVS/Pen, MSG/LA, PT 41
Battery 5	220 HPT, 220 VS, 210 HF, 210 LF, 220 B
Merrymaker Battery 2	210 HF, 220 HPT
Merrymaker 3	210 HF, 210 HF, 230 XP
Ethophone A.C. 3	MSG/LA, 41 MH, MP/Pen
Ethodyne 201/6/8/9	MS/Pen, *MVS/Pen, *MS/Pen, PT 41
214	————, ———, *DD4, *41 MH, 4 X P
209	————, ———, *DD4, MP/Pen
226 (Jubilee)	————, ———, *DD4, 42 MP/Pen
225	————, ———, *DD4, 42 MP/Pen

**C. F. & H. Burton**

Straight Three	210 HF, 210 LF, 230 XP
Class B Straight Three	210 HF, 210 LF, ———
3-valve Mains Special	*MVS/Pen, 41 MH, 42 MP/Pen, 460 BU
A.C. 2	41 MH, 42 MP/Pen, ———
Console A.C. 3	*MVS/Pen, 41 MH, 42 MP/Pen, 460 BU
A.C. Radiogram	*MVS/Pen, 41 MH, 42 MP/Pen, 460 BU
Class B.4	220 SG, 210 HF, 210 LF, ———

**Bush Radio, Ltd.**

Bush Bushranger	
A.C. Superhet	MS/Pen, MVS/Pen, 41 MH, PT 41
Bush A.V.C. Superhet	MS/Pen, MVS/Pen, MSG/LA, 41 MH, PT 41
Bush A.C. S.G.3	MSG/HA, MSG/HA, PT 41, 442 BU
Bush 5-valve Battery	220 VS, 210 HF, 210 LF, 220 HPT (2)
Bush Radiogram	*MSG/HA, *MSG/HA, PT 41, 442 BU
Bush S.B.1	*210 SPT, *210 VPT, 220 HPT
Bush S.A.C.O.	*MSG/LA, MS/Pen, MVS/Pen, 41 MH, PT 41
Bush Q.P.P.5	*215 SG, *210 HF, 210 LF, 220 HPT (2)
Bush Batt. Superhet, S.B.1	210 SPT, 210 VPT, 220 HPT
Bush S.A.C.5	————, *MVS/Pen, 41 MH, MP/Pen
Bush S.A.C.7	*MVS/Pen, ———, *MVS/Pen, *41 MH, MP/Pen
Bush S.A.C.1	————, *MVS/Pen, ———
Bush Upright Grand	————, *MVS/Pen, ———
Bush S.B.4	————, *210 VPT, ———, 220 HPT
Bush S.B.21	————, *210 VPT, 220 HPT
Bush Superhet S.A.C. 21	————, MVS/Pen, DD4, 42 MP/Pen, 442 BU
Bush Upright Grand Superhet	————, MVS/Pen, ———, 442 BU

**City Accumulator Co.**

Pentagrid Superhet	MVS/Pen, DD/Pen, MP/Pen
Austin A.C. Super	41 MPG, MVS/Pen, DDT, MP/Pen
Austin Battery Super	210 PG, 210 VPT, ———, 220 P, ———
Austin Radiogramophone	41 MPG, MVS/Pen, DDT, MP/Pen

**H. Clarke & Co.  
(Manchester) Ltd.**

Atlas A4	MVS/Pen, MS/Pen, PT 41, 442 BU
Atlas B4	220 VS, *210 HL, 220 P, 220 B
Atlas Lambda	220 VS, 210 HL, 220 PA, 220 PT
Atlas 334	MVSG, 41 MHL, 41 MP
Atlas A.C. 2	41 MH, 41 MP

SET.	COSSOR VALVES.
------	----------------

Atlas Battery 2 .. .. .	210 HF, 220 HPT
Atlas 7-5-8 .. .. .	———, *MVS/Pen, DDT, 4 XP
Atlas 345 .. .. .	*210 VPT, *210 SPT, 220 HPT

### Climax Radio Electric, Ltd.

Mains 33a .. .. .	MSG/HA, 41 MH, MP/Pen, 442 BU
M.22 .. .. .	41 MHF, 410 P
M.22a .. .. .	41 MH, MP/Pen, 442 BU
M.C.3 .. .. .	*215 SG, 210 HF, 220 HPT
S.4 .. .. .	MS/Pen, MVSG, 41 MH, MP/Pen, 442 BU
T.C.3 .. .. .	MVSG, 41 MH, MP/Pen, 442 BU
Band Pass 3, B.P. III .. .. .	*MS/Pen, 41 MH (or 41 MHL), MP/Pen
Radiogram A.C. 3 .. .. .	*MS/Pen, 41 MH (or 41 MHL), MP/Pen
B.111 and B.111 M/C .. .. .	*210 HF, 210 LF, 220 PA
B.H.111 (Class B) .. .. .	*220 SG, 210 HF, 210 LF, 220 B
B.H.111 .. .. .	*220 SG, 210 HF, 220 HPT
S.5/U and S.5/H .. .. .	———, MVSG, *41 MH, 42 MP/Pen, 442 BU
Sports S.5/W .. .. .	———, *MVSG, *41 MH, 42 MP/Pen
Sports R.G./S.5 .. .. .	———, *MVSG, *41 MH, 42 MP/Pen
All-wave Superhet, Model 534 .. .. .	———, *MVS/Pen, ——, 42 MP/Pen

### E. K. Cole, Ltd. (See Ekco)

### Columbia Graphophone Co.

303, Twin Station A.C. .. .. .	41 MHF, 415 PT
303, Twin Station D.C. .. .. .	410 LF, 415 PT
331 A.C. .. .. .	41 MSG, 41 MLF, 415 PT
Model 351 .. .. .	210 HF, 220 PA
Model 350 A.C. .. .. .	41 MHL, 410 PT
Model 350 D.C. .. .. .	410 LF, 415 PT
Model 307 A.C. .. .. .	41 MSG, 41 MLF, 415 PT
Model 303 Portable .. .. .	210 HL, 210 HL, 210 RC, 210 LF, 220 P
Model 352 A.C. .. .. .	MSG/LA, MSG/LA, 41 MHL, MP/Pen, 442 BU
Model 604 A.C. .. .. .	MSG/HA, MSG/HA, 41 MHL, MP/Pen, 442 BU
Model 331 A.C. .. .. .	41 MSG, 41 MLF, 415 PT, 506 BU
640 .. .. .	41 MLF, *MVSG (3), MSG/LA, 41 MP, 4 XP (2), 460 BU
631 .. .. .	*MVSG (2), *41 MHL (2), *MSG/HA, 4 XP 442 BU
620 .. .. .	MSG/LA, 41 MHL, MP/Pen, 442 BU
1003 C.Q.A. .. .. .	220 VSG, 210 HF, 220 HPT (2)
355 A.C. .. .. .	MSG/LA, 41 M.H.L., MP/Pen, 442 BU
355 D.C. .. .. .	DVSG, DHL, DP/Pen
1001 C.Q.A. .. .. .	220 VSG, 210 HF, 220 HPT (2)
353 .. .. .	210 HF, 220 PA
1005 .. .. .	215 SG, 210 HF, 220 HPT

### Consolidated Radio Co., Ltd.

Ranger Battery 3 .. .. .	*220 VS, *210 HF, 220 HPT
Ranger Trans. 4 .. .. .	*220 VS, *210 HF, 210 LF, 220 PT
Ranger De Luxe Batt. Superhet .. .. .	———, *210 VPT, *210 VPT, ——, 210 LF, ——

### COSSOR

Kits and Receivers .. .. See Pages 112, 113

### Cromwell (Southampton) Ltd.

Cromwell B 34 .. .. .	210 Det, 210 HF, 220 PA
Cromwell A.C./D.C. .. .. .	DVSG, DHL, DP/Pen
Cromwell 404 .. .. .	MVSG, MVSG, *MSG/HA, PT 41, 506 BU
Cromwell 404 Radiogram .. .. .	MVSG, MVSG, MSG/HA, PT 41, 506 BU
Cromwell B34B .. .. .	210 Det, 210 LF, ——
Cromwell R4FB .. .. .	*220 VS, 210 Det, 220 HPT, ——
Cromwell SH8A .. .. .	MVSG, *MVS/Pen, 41 MH, *MVS/Pen, ——, *DDT, MP/Pen, 442 BU

### C.W.S.

Defiant B.3434 .. .. .	*210 HF, 210 LF, 220 P (or 220 HPT)
Defiant B.4434 .. .. .	*210 SPT, *210 HF, 220 HPT
Defiant B.5434 .. .. .	*210 VPT, *210 HF, ——
Defiant SHB.6434 .. .. .	*210 VPT, *210 PG, *210 VPT, ——, ——
Defiant M.234 .. .. .	*MVS/Pen, *MS/Pen, 42 MP/Pen
Defiant MSH.434 .. .. .	———, *MVS/Pen, *DD4, 42 MP/Pen

SET.	COSSOR VALVES.
Defiant MSH.534 .. ..	*MVS/Pen, ———, *MVS/Pen, *DD4, 42 MP/Pen
Defiant MSH.634 .. ..	*MVS/Pen, ———, *MVS/Pen, *MVS/Pen, *DD4, *DDT, 42 MP/Pen
Defiant RG.734 .. ..	*MVS/Pen, *MS/Pen, 42 MP/Pen
Defiant RG.834 .. ..	*MVS/Pen, ———, *MVS/Pen, *DD4, 42 MP/Pen

### Edge Radio, Ltd.

Drummer B.4 .. ..	220 VS, 210 HF, 210 LF, 220 B
Drummer M.S.6 .. ..	MVS/Pen (2), MS/Pen, DDT, MP/Pen
Battery 3 .. ..	220 SG, 210 HF, 220 HPT (2)
Drummer R.B.4 .. ..	*220 VS, *210 HF, 210 LF, 220 B
Drummer R.M.S.6 .. ..	*MVS/Pen, *MS/Pen, *MVS/Pen, DDT, MP/Pen
Drummer M.S.5 .. ..	*MS/Pen, *MVS/Pen, *41 MH
Drummer M.45 .. ..	————, *MVS/Pen, *DD4, 42 MP/Pen, ———.
Drummer M.55, M.55M and M.55C .. ..	————, *MVS/Pen, *DDT, MP/Pen, ———
Drummer B.44 .. ..	————, *210 VPT, ———, 220 PT
Drummer R.G.8 .. ..	*MVS/Pen, *41 MPG, *DDT, 41 MHF, 4 XP, 4 XP
Drummer B.3 .. ..	*220 VS, *210 HF, 220 HPT

### Edison Swan-Electric Co. Ltd.

Ediswan Threesome.. ..	210 RC, 210 HL, 215 P
Ediswan 3 .. ..	215 SG, 210 Det, 220 P
Ediswan 3-valve Battery .. ..	215 SG, 210 HF, 220 P
Ediswan Power Pentode 3 .. ..	MSG/HA, 41 MHL, MP/Pen
Ediswan Regional Pentogram .. ..	MSG/HA, 41 MHL, MP/Pen

### Ekco (E. K. Cole, Ltd.)

Ekco 2-valve Mains Model 312 .. ..	41 MHL, 415 PT
Ekco 3-valve Mains Consolette (R.S.2) .. ..	MSG/HA, 41 MHL, PT 41B
Ekco Model 313 .. ..	MSG/HA, 41 MHL, PT 41 B
Ekco 4-valve Mains Consolette (R.S.3) .. ..	MSG/HA, MSG/LA, 41 MHL, PT 41B
Ekco R.G.4 Console .. ..	MSG/HA, MSG/LA, 41 MHL, PT 41B
Ekco R.G.5 Radiogram .. ..	MSG/HA, MSG/LA, 41 MHL, PT 41B
Ekco A.C. 74 .. ..	MS/Pen, MVS/Pen, DDT, MP/Pen
Ekco D.C. 74 .. ..	DS/Pen, DVS/Pen, DDT 16, DP/Pen
Ekco B.74 .. ..	215 SG, 220 VS, 210 HF, 210 LF, 220B
Ekco S.H.25 .. ..	MSG/LA, MVSG, 41 MH, 41 MHL, PT 41
Ekco M.23 A.C. .. ..	MSG/HA, 41 MHL, PT 41
Ekco M.23, D.C. .. ..	410 SG, 410 LF, 410 PT
Ekco B.54 .. ..	*210 SPT, *210 RC, 210 LF, 220 B
Ekco R.G. 25 .. ..	MSG/LA, MVSG, 41 MH, 41 MHL, PT 41
Ekco A.C. 85 .. ..	————, *MVS/Pen, DD4, 41 MHF, MP/Pen, 506 BU
Ekco R.G.84 A.C. .. ..	MS/Pen, *MVS/Pen, *DDT, MP/Pen
Ekco A.C. 86 .. ..	————, MVS/Pen, DD4, 41 MHL, MP/Pen, ———
Ekco R.G. 86 .. ..	————, MVS/Pen, DD4, 41 MHL, MP/Pen, ———
Ekco A.C. 76 .. ..	————, MVS/Pen, DD4, 42 MP/Pen, ———
Ekco A.C.T. 96 .. ..	MVS/Pen, ———, MVS/Pen, DD4, MP/Pen, ———

### Electrical Radio Products, Ltd.

Belgrave and Claremont Portables .. ..	215 SG, 210 RC, 210 RC, 220 HPT
Gainsborough A.C.4 and Radiogram .. ..	MVSG, MVSG, MSG/LA, 41 MXP, 442 BU
Mayfair Superhet Radiogram .. ..	MSG/LA, 41 MH, MVSG (3), MP/Pen, 442 BU
E.R.P. A.C.4 .. ..	MS/Pen, MVS/Pen, MS/Pen, MP/Pen
E.R.P. A.C.3 .. ..	MVS/Pen, 41 MH, MP/Pen

### Ever Ready Radio, Ltd.

5001 .. ..	*220 VS, ———, *210 VPT, 210 LF, 220 B
------------	---------------------------------------

**Ferranti, Ltd.**

Ferranti 21 .. .. .	41 MHF, 625 P
Ferranti 22 .. .. .	41 MHF, 625 P
Ferranti Model 31 .. .. .	MSG/HA, 41 MHL, 625 P, 506 BU
Ferranti Inductor Console .. .. .	MSG/HA, 41 MHL, 625 P, 506 BU
Ferranti Model 32 .. .. .	MSG/HA, 41 MHL, 625 P
Ferranti M.C. Console .. .. .	MSG/HA, 41 MHL, 625 P
Ferranti Gloria Consolette .. .. .	41 MHL, MVS/Pen (3), DDT, 41 MP, 442 BU
A.C. B.P. Superhet Console .. .. .	MVS/Pen (3), 41 MH (2), 4 XP, 442 BU
Gloria A.C. Receivers .. .. .	MVS/Pen (3), DDT, 41 MH, 41 MXP, 442 BU
Lancastria and Arcadia A.C. Receivers (Parva, Magna, and R.G.) .. .. .	41 MPG, MVS/Pen, DDT, 41 MXP, 442 BU
The Lancastria Consolette .. .. .	41 MPG, MVS/Pen, ———, 442 BU
The Arcadia Consolette .. .. .	41 MPG, *MVS/Pen, DDT, ———, 442 BU
The Arcadiagram .. .. .	41 MPG, MVS/Pen, DDT, ———, 442 BU
The Gloria Consolette .. .. .	MVS/Pen (2), 41 MPG, DDT, ———, 442 BU
Lancastria Battery Portable .. .. .	210 PG, 220 VS, 220 VS, ———, 220 PA, 220 B
Una Consolette .. .. .	MVS/Pen, MHL, ———, 442 BU
Nova .. .. .	41 MPG, MVS/Pen, ———, 442 BU
Gloria Radiogram .. .. .	41 MPG, MVS/Pen, DDT, ———, 4 XP (2), 442 BU

‡ Note.—Cossor MVS/Pen suitable only for Models so marked at rear.

**General Electric Co., Ltd.**

Gecophone 6-valve Superhet .. .. .	215 SG (3), 210 RC (2), 230 XP
G.E.C. Osram Music Magnet Kit .. .. .	215 SG, 215 SG, 210 HL, 220 PA
G.E.C. Osram Music Magnet 3 .. .. .	215 SG, 210 RC, 220 P
G.E.C. Gecophone 3 .. .. .	215 SG, 210 Det., 220 P
G.E.C. Victor 3 .. .. .	210 RC, 210 HF, 220 P
G.E.C. A.C. 4 .. .. .	41 MSG, 41 MSG, 41 MHF, 4 XP
G.E.C. Portable S.G. 4 .. .. .	215 S.G., 210 HL, 210 HF, 230 XP
G.E.C. Superhet 5 Table Mod. .. .. .	MSG/LA (2), MVSG, MP/Pen, 442 BU
G.E.C. Battery M.C. 3 .. .. .	210 HF, 210 HF, 230 XP
G.E.C. Osram 33 Music Magnet .. .. .	215 SG, 215 SG, 220 PA
G.E.C. Compact 3 (BC 3536) .. .. .	*210 HL, *210 HL, 230 XP
G.E.C. Superhet D.C. 5 .. .. .	DVSG (3), DP/Pen
G.E.C. Overseas 7 .. .. .	*MVS/Pen (3), 41 MP, DDT, MP/Pen, 442 BU
G.E.C. CB4 .. .. .	220 VS, 210 VPT, 210 LF, ———
G.E.C. Superhet AVC.6 .. .. .	220 VS, 210 PG, 220 VS, ———, 210 LF, ———
G.E.C. A.C. 4 Superhet .. .. .	41 MPG, MVS/Pen, ———, 442 BU
G.E.C. S.G. 3 .. .. .	*220 VS, *210 VPT, 220 HPT
G.E.C. Fidelity A.C. 5 .. .. .	41 MPG, MVS/Pen, ———, MP/Pen, 442 BU
G.E.C. Fidelity Radiogram 5 .. .. .	41 MPG, MVS/Pen, ———, MP/Pen, 442 BU

**J. G. Graves, Ltd.**

Graves 2 .. .. .	210 HF, 220 P
Graves 3 .. .. .	215 SG, 210 RC, 230 XP
Graves A.C. 3 .. .. .	MSG/HA, 41 MH, PT 41, 442 BU
Graves S.G. 3 .. .. .	210 VPT, 210 HF, 220 HPT
National 3 .. .. .	210 HF (2), 230 XP
Mercury .. .. .	215 SG, 210 HF, 220 HPT (2)
Mercury Pedestal .. .. .	220 VS, 210 HF, 230 XP
Astoria Band Pass 3 .. .. .	MSG/HA, 41 MH, PT 41, 442 BU
National Mains 3 .. .. .	*MVS/Pen, *MSG/LA, PT 41, 442 BU
Graves Superhet .. .. .	MS/Pen, MVS/Pen, 41 MH, MP/Pen
Pluto S.G. 3 .. .. .	220 SG, 210 HF, 220 PA
Practica .. .. .	210 HF, 220 PA
Astoria .. .. .	*MVS/Pen, *MSG/LA (or *MS/Pen), PT 41
Battery Superhet .. .. .	*210 SPT, *210 VPT, 215 SG, 220 HPT
Mains Superhet .. .. .	*MS/Pen, *MVS/Pen, *MSG/LA, PT 41
Mimerva Battery 3 .. .. .	210 HF, 210 HF, 230 XP
National All Mains 3 .. .. .	*MVS/Pen, *MS/Pen, 42 MP/Pen

**The Gramophone Co.**

H.M.V. 532 .. .. .	*MVSG (3), 41 MLF, *41 MHL, MSG/LA, 41 MP, 4 XP (2), 460 BU
H.M.V. 524 & 467 .. .. .	*MVSG (3), *41 MHL (2), 4 XP, 442 BU
H.M.V. 523 .. .. .	MVSG (2), 41 MHL (2), MSG/HA, 4 XP, 442 BU
H.M.V. 470 A.C. .. .. .	*MVSG (2), *41 MHL (2), *MSG/HA, 4 XP, 442 BU



**The Gramophone Co.—contd.**

H.M.V. 470 D.C. . . . .	*DVSG (3), *DHL (2), DP/Pen (2),
H.M.V. 438 & 512 . . . . .	MSG/LA, MVSG, 41 MHL, MP/Pen, 442 BU
H.M.V. 146 . . . . .	*210 PG, *220 VS, _____
H.M.V. 436 . . . . .	MSG/LA, 41 MHL, MP/Pen, 442 BU
H.M.V. Superhet Portable 6 (459) . . . . .	*215 SG (3), *210 HF (2), 220 HPT
H.M.V. Radiogram A.C.5 (521 & 522) . . . . .	MSG/LA (2), *41 MH, 615 PT, 506 BU
H.M.V. 436 D.C. . . . .	DVSG, DHL, DP/Pen
H.M.V. 501 A.C. and 435 . . . . .	*MSG/LA, 41 MHL, MP/Pen, 506 BU
H.M.V. 520 A.C. . . . .	*MSG/LA, 41 MHL, 41 MLF, 4 XP, 506 BU
H.M.V. 467 D.C. . . . .	*DVSG, *DHL, _____, *DVSG, *DHL, DP/Pen (2)
H.M.V. 442 . . . . .	41 MPG, *MVSG, *DDT, 4 XP, 442 BU
H.M.V. 463 . . . . .	*MVSG, MSG/LA, *MVSG, *DDT, MP/Pen
H.M.V. Superhet 540 & 542 A.C. . . . .	MSG/LA, MVSG, 41 MH, MP/Pen, 442 BU
H.M.V. Superhet 540 D.C. . . . .	*DVSG (2), *DHL, DP/Pen
H.M.V. 570 A.C. . . . .	41 MPG, MVSG, DDT, 4 XP, 442 BU
H.M.V. 580 A.C., Duo- diffusion R.G. . . . .	MVSG, 41 MPG, MVSG, MSG/LA, DDT (2), 4 XP (2)
H.M.V. High Fidelity 800 A.C. . . . .	*MVSG, 41 MHL, *41 MHL, *MVSG, *MVSG, MSG/LA, MS/Pen, *DDT, *DDT, *41 MHL, MVS/Pen, _____, 460 BU
H.M.V. 462 . . . . .	215 S.G. (2), 220 V.SG, 210 HF, 220 HPT (2)
H.M.V. 440 A.C. . . . .	MSG/LA, MVSG, 41 MHL, MP/Pen, 442 BU
H.M.V. 440 D.C. . . . .	DVSG (2), DHL, DPT
H.M.V. Battery S.G. 3, 148 . . . . .	*215 SG, *210 HF, 220 HPT

**Halcyon Radio Ltd.**

Superhet Portable . . . . .	215 SG (2), 210 DG, 210 LF, 230 PT
Battery 3 . . . . .	220 SG, 210 HF, 220 PT
Battery 4 . . . . .	220 SG, 210 HF, 210 LF, 220 B
Superhet 7 . . . . .	41 MH, MVS/Pen (3), DDT, MP/Pen
6701, Table Model . . . . .	*MS/Pen, *MVS/Pen, 41 MH, *MVS/Pen, *DDT, MP/Pen
6701C, Console . . . . .	*MS/Pen, *MVS/Pen, 41 MH, *MVS/Pen, *DDT, MP/Pen
6701G and 6701GE . . . . .	*MS/Pen, *MVS/Pen, 41 MH, *MVS/Pen, *DDT, MP/Pen
301 . . . . .	220 VS, 210 Det, 220 PA
401 . . . . .	220 VS, 210 Det, 210 LF, _____

**H.S.P. Wireless Co.**

H.S.P. Battery 4 . . . . .	220 SG, 210 HF, 210 LF, 230 XP
H.S.P. B.P.3 . . . . .	MSG/LA, 41 MH, MP/Pen
H.S.P. D.B.P.3 . . . . .	MVSG, 41 MH, MP/Pen, 442 BU
H.S.P. C.B.5 . . . . .	220 SG, 210 HF, 210 RC, 215 P, 220 B
H.S.P. D.B.P.4 . . . . .	MSG/LA (2), MP/Pen
H.S.P. S.H.5 . . . . .	MP/Pen, MVS/Pen, *41 MH, MP/Pen
H.S.P. R.G.4 . . . . .	MSG/LA (2), MP/Pen
H.S.P. R.G.S.5 . . . . .	MP/Pen, MVS/Pen, *41 MH, MP/Pen
H.S.P. Superhet A.C. . . . .	_____, *MVS/Pen, *DDT, 42 MP/Pen
H.S.P. Radiogram A.C. . . . .	_____, *MVS/Pen, *DDT, 42 MP/Pen

**Kendic Super Radio**

Kendic Battery Three . . . . .	*210 SPT, *210 HL, 220 HPT (5-pin).
Kendic Class "B" Four . . . . .	*210 VPT, *210 HL, 215 P, 220 B
Kendic Mains Four . . . . .	MS/Pen, 41 MHL, MP/Pen, 442 BU
Kendic Super Six . . . . .	*41 MPG, *MVS/Pen, *DD4, *MVS/Pen, MP/Pen, 442 BU
Kendic Super S.G.3 . . . . .	*220 VS, *210 HL, 220 PA
Kendic Super S.G.4 . . . . .	*220 VS, *210 HL, 215 P, 220 B
Kendic 3 V.S. . . . .	210 HL, 210 HL, 220 PA
Kendic Super S.G.4M . . . . .	*DVSG, *DHL, DP/Pen

**Kolster Brandes, Ltd.**

K.B. Portable 5 . . . . .	210 HL, 210 HL, 210 RC, 210 LF, 220 P
K.B. 156 . . . . .	210 RC, 210 HF, 220 P
K.B. 163 . . . . .	215 SG, 210 HF, 230 XP
K.B. 242 . . . . .	410 SG, 410 HF, 410 P, 425 XP
K.B. A.C.2 . . . . .	41 MHF, 415 PT

**Kolster Brandes, Ltd.—contd.**

K.B. A.C.3	.. .. .	41 MSG, 41 MHF, 415 PT
K.B. Kitten	.. .. .	210 HL, 220 PA
K.B. Pup	.. .. .	210 HL, 220 PA
K.B. 252	.. .. .	41 MHL, 41 MP, 506 BU
K.B. 253	.. .. .	41 MHL, 41 MP, 506 BU
K.B. 291 (Kobra)	.. .. .	210 HF, 210 HF, 220 P
K.B. 274	.. .. .	210 HF, 210 HF, 220 P
K.B. 281	.. .. .	215 SG, 210 HF, 220 HPT
K.B. 279	.. .. .	MSG/LA, 41 MHL, PT 41B, 442 BU
K.B. 286	.. .. .	MSG/LA (3), 41 MHL (2), MP/Pen
K.B. 888	.. .. .	MS/Pen, MVS/Pen (2), DDT, MP/Pen, 442 BU
K.B. 666	.. .. .	MS/Pen, MVS/Pen, (2) DDT, MP/Pen 442 BU
K.B. 444	.. .. .	MS/Pen, MS/Pen, MP/Pen, 442 BU
K.B. 333	.. .. .	220 VS, 220 SG, 220 HPT
K.B. 321	.. .. .	MSG/LA, 41 MH, PT 41, 442 BU
K.B. 320	.. .. .	MVSG, MVSG, 41 MH, PT 41, 442 BU
K.B. 333A, B.P.S.G.3	.. .. .	*220 VS, *215 SG, 220 PT
K.B. 362 New Pup	.. .. .	*210 HF, *210 Det, 220 PT
K.B. 363 Class B	.. .. .	220 VS, *210 HL, 215 P, 240 B
K.B. 364 de Luxe	.. .. .	*220 VS, *215 SG, 220 PT
K.B. 365	.. .. .	MS/Pen (2), MP/Pen, 442 BU
K.B. 366	.. .. .	*MVS/Pen, *MS/Pen, *MVS/Pen, *DDT, ———, MP/Pen (2)
K.B. 378	.. .. .	MS/Pen, MVS/Pen (2), DDT, MP/Pen, 442 BU
K.B. 381	.. .. .	13 PGA, 13 VPA, 13 DHA, 40 PPA
K.B. 393 S.G.3	.. .. .	*220 VS, *210 HF, 220 HPT
K.B. 397 A.C. Pup	.. .. .	41 MHL, 42 MP/Pen
K.B. 398	.. .. .	210 VPT, 210 VPT, 210 VPT, 220 DD, 215 P, 240 B
K.B. 393	.. .. .	210 HF, 210 HL, 220 HPT
K.B. Hika	.. .. .	215 SG, 210 HF, 210 HF, 220 HPT
K.B. Short-wave Converter	.. .. .	*MS/Pen
K.B. 402	.. .. .	*MS/Pen (2), MP/Pen, ———
K.B. 396	.. .. .	*220 VS, *210 HF, 220 PA, 220 B
K.B. 935	.. .. .	*MVS/Pen, *MS/Pen, *DDT, MP/Pen, ———
K.B. 405	.. .. .	*13 VPA, *13 PGA, 13VPA, 13DHA, 40PPA, 40 SUA
K.B. 425	.. .. .	13 VPA, 13PGA, 13 VPA, 13 DHA, 40 PPA, 40 SUA
K.B. 426	.. .. .	13 PGA, 13 VPA, ———, ———, 40 SUA
K.B. 429	.. .. .	*210 VPT, *210 HF, 220 HPT
K.B. 430	.. .. .	13 VPA ———, ———, 40 SUA
K.B. 431	.. .. .	210 HF, 210 HF, 220 HPT
K.B. 433	.. .. .	41 MH, 42 MP/Pen, 442 BU

**Lissen, Ltd.**

S.G.3	.. .. .	215 SG, 210 HF, 220 P
Colossus	.. .. .	210 HL, 220 P
Popular	.. .. .	210 HL, 220 HPT
A.C.2	.. .. .	41 MHL, 415 PT, 612 BU
Band Pass 3	.. .. .	MSG/LA, 41 MHL, MP/Pen, 506 BU
Portable Five de Luxe	.. .. .	210 RC, 210 HL, 210 HL, 210 LF, 220 P
Portable	.. .. .	210 HL, 210 HL, 210 RC, 210 LF, 220 P
Competition Portable Five	.. .. .	210 RC, 210 HL, 210 HL, 210 LF, 220 P
Salon Four Transportable	.. .. .	215 SG, 210 HF, 210 LF, 220 P
Salon A.C. Transportable	.. .. .	MSG/HA 41 MHF, 410 P, 425 XP
Trans portable Three	.. .. .	210 HL, 210 HL, 220 P
Trans portable Two	.. .. .	210 RC, 220 HPT
Transportable Four	.. .. .	MSG/LA, MSG/LA, 41 MHL, 425 XP
Transportable Two, A.C.	.. .. .	41 MHF, 415 PT
Model 8051	.. .. .	MVSG, 41 MH, 410 PT
Model 8033	.. .. .	*215 SG, 210 HL, 220 HPT
Model 8020	.. .. .	210 HL, 220 HPT
Model 8019	.. .. .	*215 SG, 210 HL, 220 HPT
Model 8030	.. .. .	210 HL, 210 Det, 220 P
Skyscraper 3 Kit	.. .. .	*215 SG, 210 HL, 220 HPT
Skyscraper A.C. Kit	.. .. .	MVSG, 41 MH, 410 PT
Skyscraper All-wave Kit	.. .. .	*220 VS, *215 SG, 220 PT (2)
Skyscraper B.P.3	.. .. .	*220 VS, 210 Det, 220 HPT
Skyscraper All Wave 4	.. .. .	*220 VS, 215 SG, 220 PT (2)
Models 8093 and 8095	.. .. .	MVSG, 41 MH, MP/Pen
Model 8073	.. .. .	220 VS, 210 Det, 220 HPT
Model 8044	.. .. .	210 HL, 220 PT (2)
Model 8099	.. .. .	*215 SG, 210 HL, 220 HPT
Model 8098	.. .. .	*215 SG, 210 HL, 220 HPT
Model 8100	.. .. .	210 HF (2), 220 HPT
Model 8109	.. .. .	———, 210 VPT, ———, 220 HPT or 220 PT
A.C. Band Pass Superhet	.. .. .	———, MVS/Pen, DD4, 42 MP/Pen, ———

**Lotus Radio, Ltd.**

3-valve All Mains	.. .. .	MSG/LA, 41 MHL, 41 MP
3-valve Battery	.. .. .	215 SG, 210 HF, 220 PA
3-valve Kit	.. .. .	210 HL, 210 LF, 220 P
Long Range 4	.. .. .	MVSG (2), 41 MH, MP/Pen
A.C. Band Pass 3	.. .. .	MVSG, *41 MH, MP/Pen
Band Pass Battery 3	.. .. .	*220 SG, *210 HF, 220 HPT
Landmark Kit	.. .. .	210 RC, 210 HF, 220 PA
Bud A.C.2	.. .. .	*41 MH, 41 MP

**Marconiphone Co., Ltd.**

Marconi Portable 55	.. .. .	210 HL, 210 HL, 210 HL, 210 LF, 215 P
4-valve Portable	.. .. .	215 SG, 210 HF, 210 HF, 220 HPT
Model 47	.. .. .	41 MSG, 41 MHF, 41 MRC, 4 XP
Model 39	.. .. .	41 MSG, 41 MHF, 425 XP
Model 220	.. .. .	41 MHF, 41 MP
Model 221	.. .. .	210 HL, 230 PT
Super Power 2 (246 A.C.)	.. .. .	41 MHL, MP/Pen, 506 BU
Model 42	.. .. .	MSG/LA, 41 MHL, MP/Pen, 506 BU
Model 39 A.C.	.. .. .	MSG/LA, 41 MHL, 425 XP
Battery Model 39	.. .. .	215 SG, 210 HF, 220 PA
Radiogram Model 330	.. .. .	MSG/LA, 41 MHL, MP/Pen, 506 BU
Model 248	.. .. .	*210 HF, 220 PA
Model 283	.. .. .	*215 SG 210 HF 220 HPT
Model 260	.. .. .	*220 VSG, 210 HF, 220 HPT (2)
Model 255	.. .. .	*215 SG (3), *210 HF (2), 220 HPT
Model 253	.. .. .	MSG/LA, 41 MHL, MP/Pen, 442 BU
Models 272 and 274	.. .. .	*MVSG, MSG/LA, *41 MHL, MP/Pen, 442 BU
Models 276 and 290	.. .. .	*MVSG (2), *MSG/LA, 41 MHL (2), 4 XP, 442 BU
Model 271	.. .. .	MSG/LA, 41 MHL, MP/Pen, 442 BU
Model 292 A.C.	.. .. .	*MVSG, *41 MPG, *MVSG, *MSG/LA, *DDT, *DDT, 4 XP (2)
Model 291 A.C.	.. .. .	*MVSG, *MSG/LA, *41 MH, *MVSG, *41 MH, 4 XP, 442 BU
Model 286 A.C.	.. .. .	MSG/LA, *MVSG, *41 MH, MP/Pen, 442 BU
Model 289	.. .. .	—, *MVSG, DDT, 4 XP, 442 BU
Model 269M, Battery Portable	.. .. .	215 SG, *215 SG, *220 VSG, *210 HF, 220 HPT (2)
Model 273M, Battery Superhet	.. .. .	*220 VS, 215 SG, *220 VSG, —, —
Models 284M and 284A, Battery 3-valve	.. .. .	*215 SG, 210 HF, 220 HPT
Model 276 A.C.	.. .. .	*MVSG (2), *MSG/LA, *41 MH (2), 4 XP, 442 BU
Model 296 A.C.	.. .. .	41 MPG, *MVSG, DDT, 4 XP, 442 BU
Model 262 A.C.	.. .. .	MSG/LA, *MVSG, *41 MH, MP/Pen, 442 BU
Model 262 D.C.	.. .. .	*DVSG, *DVSG, *DHL, DP/Pen
Model 279 A.C.	.. .. .	*MVSG (2), MSG/LA, DDT, MP/Pen
Model 66	.. .. .	215 SG, 210 HF, 210 HL, 220 HPT
Model 560	.. .. .	41 MSG, 41 MSG, 41 MHL, 615 PT, 506 BU
Model 285	.. .. .	220 VS, 210 HF, 220 HPT (2)
Model Q286 Lucerne Special	.. .. .	—, MVSG, DDT, MP/Pen, 442 BU
Model 288 A.C.	.. .. .	MSG/LA, MVSG, 41 MHL, MP/Pen, 442 BU
Model 257	.. .. .	210 PG, 220 VS, —, —
Model 276 (D.C.)	.. .. .	*DVSG, *DVSG, *DVSG, *DHL, *DHL, DP/Pen
Model 286 (D.C.)	.. .. .	*DVSG, *DVSG, *DHL, DP/Pen
Model 288 (D.C.)	.. .. .	*DVSG, *DVSG, *DHL, DP/Pen
Model 264, Table	.. .. .	—, *MVSG, *DDT, MP/Pen
Model 297, Console	.. .. .	—, *MVSG, *DDT, MP/Pen
Model 287, Radiogram	.. .. .	—, *MVSG, *DDT, MP/Pen

**McMichael Radio, Ltd.**

Battery 3	.. .. .	215 SG, 210 HL, 230 PT
Dimic 3	.. .. .	215 SG, 210 HL, 230 PT
Moving Coil Mains 3	.. .. .	MSG/LA, 41 MHL, MP/Pen, 442 BU
3-valve Radiogram	.. .. .	MSG/LA, 41 MHL, MP/Pen, 442 BU
Colonial S.W. Super	.. .. .	215 SG, 215 SG, 210 HL, 220 P
4-valve Super Range Portable	.. .. .	215 SG, 210 HL, 210 HL, 220 P
Super Range 4	.. .. .	220 SG, 210 HL, 210 HL, 220 PA
Super Range Transportable	.. .. .	215 SG, 210 HL, 210 HL, 220 PA
Twin Supervoxx	.. .. .	*MSG/LA, *MSG/LA, 41 MHF, MP/Pen
Lodex 5	.. .. .	215 SG, 215 SG, 210 HF, 215 P, 240 B
Super 5, Class B	.. .. .	215 SG, 210 HF (2), 215 P, 240 B
Duplex Mains 4	.. .. .	MSG/LA, MS/Pen, 41 MHL, MP/Pen
Duplex Suitcase Portable	.. .. .	215 SG, 210 HL, 210 HL, 220 HPT
Superhet Mains Transportable	.. .. .	MVS/Pen (2), —, DD/Pen, MP/Pen
A.C. Superhet	.. .. .	—, MVSG, DDT, MP/Pen
Transportable Mains	.. .. .	—, MVSG, DDT, MP/Pen

**Mullard Wireless Service Co. and Radio for the Million**

Master 3 .. .. .	210 RC, 210 LF, 220 P
Master 3 Star .. .. .	210 Det, 210 LF, 230 XP
Orgola 3 .. .. .	215 SG, 210 Det, 230 PT
Orgola 4 .. .. .	215 SG, 215 SG, 210 HL, 230 PT
Toreador .. .. .	210 HF, 215 P
S.G.P. M.3 .. .. .	215 SG, 210 Det, 220 PT
Orgola A.C. .. .. .	41 MSG, 41 MH, 410 PT
Orgola Senior .. .. .	220 SG (2), 210 HF, 210 LF, 230 XP (2)
Orgola Senior A.C. .. .. .	41 MSG (2), 41 MH, 4 XP (2)
Master Super .. .. .	41 MHL, MSG/LA, MVSG, MSG/HA, MP/Pen
Stationmaster 3 .. .. .	215 SG, 210 HF, 220 PA
Stationmaster 3 A.C. .. .. .	MSG/LA, 41 MH, MP/Pen, 506 BU
Stationmaster 34 .. .. .	220 SG, 210 HF, 220 HPT
Stationmaster 34, Class B .. .. .	220 VS, 210 Det, 220 PA, 220 B
Mullard M.B.3 .. .. .	*210 VPT, *210 SPT, 220 HPT
Mullard M.B.4 .. .. .	210 VPT, 210 SPT, 210 LF, ———
Mullard M.B.3A .. .. .	210 VPT, 210 SPT, 220 HPT, ———

**Murphy Radio, Ltd.**

A.3 .. .. .	MSG/HA, 41 MHL, MP/Pen, 506 BU
B.4 .. .. .	215 SG, 210 Det, 210 LF, 220 P (or 230 XP)
A.4 .. .. .	MP/Pen (2), *MVSG, 41 MHL, 442 BU
B.5 .. .. .	220 PT, 220 VS, 210 HL, 210 LF, 220 B
A.8 .. .. .	*MVSG (4), 41 MHL, DD4, MP/Pen, MVSG, 442 BU
B24 .. .. .	*210 VPT, ———, *210 VPT, ———, ———
A24 .. .. .	————, *MVS/Pen, *DDT, MP/Pen
A24 Console .. .. .	————, *MVS/Pen, *DDT, MP/Pen
A24 Radiogram .. .. .	————, *MVS/Pen, *DDT, MP/Pen

**Ormond Engineering Co., Ltd.**

Suitcase "5" .. .. .	210 LF, 210 HL, 210 HL, 210 HL, 215 P
Suitcase "4" .. .. .	215 SG, 210 RC, 210 HF, 215 P
Cabinet Transportable A.C. .. .. .	MSG/HA, 41 MHF, 415 PT
Model R.404 .. .. .	215 SG, 210 RC, 210 HF, 215 P
Model R.405 .. .. .	215 SG, 210 RC, 210 HF, 215 P
Model R.408 .. .. .	MSG/HA, 41 MHL, 415 PT, 408 BU
Model 601 .. .. .	*210 HF, 210 LF, 220 B
Model 602 .. .. .	*210 HF, 210 LF, 220 B
Model 603 (Dual Speakers) .. .. .	*210 HF, 210 LF, 220 B
Model 605 .. .. .	*210 VPT, *210 Det, 220 HPT

**Orr Radio (United Radio Mnftrs. Ltd.)**

Invicta 635 A.C. Superhet .. .. .	————, MVS/Pen, *DD4, 41 MH, MP/Pen
Invicta Duovox 635 D Sup/het .. .. .	————, MVS/Pen, *DD4, 41 MH, MP/Pen
Invicta Band Pass T .. .. .	*210 VPT, *210 SPT, 220 HPT
Invicta D.3 Series .. .. .	*210 HF (2), 220 PA
Orr A.F. .. .. .	*MVS/Pen, *41 MH, MP/Pen, 506 BU
Orr S.F. .. .. .	*MS/Pen, MVS/Pen*, *41 MH, MP/Pen, 442 BU
Orr T.2B .. .. .	*220 SG, *210 HF, 220 PA, 220 B
Orr D.2 .. .. .	210 HF (2), 220 PA
Orr T.S.G. .. .. .	*220 SG, 210 HF, 220 HPT
Radiogram Superhet 635 .. .. .	————, *MVS/Pen, *DD4, *41 MH, MP/Pen
Invicta Battery Superhet .. .. .	————, *210 VPT, ———, 220 HPT
Invicta A.C./45 .. .. .	————, ———, DD4, 42 MP/Pen

**Phillips Lamps, Ltd.**

215 A.C. .. .. .	41 MHF, 415 PT
2502 Battery .. .. .	410 SG, 410 LF, 415 PT
2514 A.C. .. .. .	41 MSG, 41 MLF, 415 PT
3-valve Mains (930a) .. .. .	41 MHL, 41 MHL, 415 PT, 506 BU
4-valve Short Wave .. .. .	410 SG, 410 LF, 410 LF, 415 PT
Model 834A .. .. .	*MVSG, *MSG/LA, 41 MHL, PT 41, 506 BU
Model 832B .. .. .	*215 SG, *215 SG, *210 HF, 210 Det, 220 HPT
Model 636A .. .. .	*MVSG (2), MSG/LA, ———, *41 MH (2), MP/Pen, 506 BU
Model 274A .. .. .	*41 MH, *MSG/LA, *MVSG, PT 41, 506 BU
Models 588A & 538A, R.G. .. .. .	————, *MVS/Pen, *DD4, *MS/Pen, PT 41, 506 BU

**Phillips Lamps, Ltd.—contd.**

Model 372B .. .. .	*220 VS, *220 SG (2), *210 HF, 210 LF, 220 B
Model 472A .. .. .	*MVS/Pen (2), —, *MS/Pen, MP/Pen, 506 BU
Models 830B & 834B .. .. .	*220 SG (2), *210 HF, 210 Det, 220 HPT
Model 2511 .. .. .	*41 MSG, *41 MSG, 41 MLF, —, 506 BU
Model 2515 .. .. .	41 MHL, 415 PT, 506 BU
Model 2522 .. .. .	215 SG, 210 Det, 210 LF, 220 PT
Model 2531 .. .. .	41 MSG, 41 MHL, —, 506 BU
Model 2532 .. .. .	410 SG, 410 HF, 415 PT
Models 2534 & 2634 .. .. .	41 MSG, 41 MHL, 415 PT, 506 BU
Model 2802 .. .. .	410 SG, 410 HF, 410 LF, 415 PT
Model 2811 .. .. .	41 MSG, 41 MSG, 41 MLF, —, 506 BU, 460 BU
Model 2601 .. .. .	41 MSG, 41 MSG, 41 MHL, —, 506 BU
Models 730A, 720A & 630A .. .. .	*MSG/LA, *MSG/LA, 41 MHL, 41 MHL, —, 506 BU
Model 44 .. .. .	41 MSG, 41 MSG, 41 MHL, —, 506 BU
Models 870A & 830A .. .. .	*MSG/LA (2), 41 MHL, —, 506 BU
Model 634A .. .. .	*MSG/LA (2), —, —, 506 BU
1934/5	
Model 372B .. .. .	*220 VS, *220 SG, *210 HF, *220 SG, 210 LF, 220 B
Model 274A .. .. .	*41 MHL, MSG/LA, *MVSG, 415 PT, 506 BU
Model 580 .. .. .	—, *MVS/Pen, DD4, *MS/Pen, PT 41, 442 BU
Model 584 .. .. .	—, *MVS/Pen, DD4, *MS/Pen, PT 41, 506 BU

**Portadyne Radio, Ltd.**

Atlantic .. .. .	*215 SG, *210 HF, *210 HF, 220 PA
4-valve Portable .. .. .	215 SG, 210 HF, 210 HF, 220 PA
F.B. Battery Portable .. .. .	220 SG, 210 Det, 210 Det, 210 LF, 220 B
Model B.M.C.4 .. .. .	*220 SG, *210 HF (2), 220 HPT
Challenger .. .. .	*220 SG, *210 HF (2), 220 PA
Model A.B.5 .. .. .	*215 SG, *220 SG, *210 Det, 210 LF, 220 B
Model F.B.5 .. .. .	*220 SG, *210 Det (2), 210 LF, 220 B
Model M.C.2 .. .. .	*210 HF, 220 HPT
Model M.C.4 .. .. .	*215 SG, *220 SG, *210 HF, 220 HPT
Model P.A.6 .. .. .	*MVS/Pen, —, *MVS/Pen, *DDT, 42 MP/Pen, —
Model P.B.6 .. .. .	*210 VPT, *210 SPT, *210 VPT, —, 210 LF, 220 B
Model A.37 .. .. .	—, *MVS/Pen, *DDT, 42 MP/Pen, —
Masterset SSTM .. .. .	*MVS/Pen, *41 MP, *MVS/Pen, *DDT, 42 MP/Pen
Masterset SSTB .. .. .	*210 VPT, *210 SPT, —, 210 LF, 220 B
Masterset SSM .. .. .	—, *MVS/Pen, *DDT, 42 MP/Pen
Masterset SSB .. .. .	—, *210 VPT, —, 210 LF, 220 B
Model B.3 .. .. .	210 VPT, 210 HF, 220 HPT
Jubilee Battery 5 .. .. .	—, *210 VPT, —, 210 LF, 220 B
Model A.C.5 .. .. .	—, *MVS/Pen, *DDT, 42 MP/Pen

**Pye Radio, Ltd.**

A.C. (AC4D) .. .. .	MSG/HA, MSG/HA, 41 MHL, 41 MP
Q Portable .. .. .	215 SG, 210 HF, 210 HF, 220 HPT
4-valve Portable Twin Triple (B.D.4) .. .. .	215 SG, 215 SG, 210 HF, 220 P
Twin Triple A.C. .. .. .	41 MSG, 41 MSG, 41 MHL, 41 MP
Straight Five .. .. .	210 HL, 210 HL, 210 HF, 210 HF, 220 P
2-valve Battery .. .. .	210 HF, 215 P
All Mains M.M. .. .. .	MSG/LA, 41 MHL, MP/Pen
Model E/B .. .. .	220 VS (3), 210 LF, 220 B
Model P/B Portable .. .. .	220 VS (3), 210 LF, 220 B
Model E/AC .. .. .	MS/Pen, MVSG (2), DDT, 4 XP
Model G .. .. .	MVSG, 41 MH, MP/Pen
Model K .. .. .	41 MH, MP/Pen
Model P/AC .. .. .	*MVS/Pen, *MVSG (2), DDT, MP/Pen
Model S .. .. .	*MVSG, 41 MH, MP/Pen
Model O.B. .. .. .	*220 VS, *210 HF (2), 220 PT
Models G/AC & G/AC/RG .. .. .	MVSG, 41 MH, MP/Pen
Models S & S/RG .. .. .	*MVSG (2), MSG/LA, 41 MH (2), MP/Pen
Model G.B. .. .. .	*220 VS, *210 HF, 220 HPT (2)
Cambridge Radiograms .. .. .	MVS/Pen (2), MS/Pen, DDT, 42 MP/Pen
Models CR/AC & E/RG/AC .. .. .	MVS/Pen (2), MS/Pen, DDT, 4 XP
Model T.7 .. .. .	—, MVS/Pen, DD4, 42 MP/Pen, 442 BU
Model T.9 .. .. .	—, MVS/Pen, DDT, 4 XP, 442 BU

**Radio Gramophone Development Co.**

R.G.D. Popular Radiogram ..	MSG/LA (2), 41 MHL (2), 41 MP (2)
R.G.D. De Luxe ..	MSG/LA (2), 41 MHL (2), 41 MP (2)
RGD 901 Radiogram ..	MVSG (2), 41 MLF, MSG/HA, 41 MP, 41 MH, 4 XP (2), 460 BU
RGD 701 Radiogram ..	MSG/HA, 41 MLF, MVSG (2), 41 MH, 4 XP
RGD 1201 ..	*MVSG (3), *41 MHL (3), 41 MLF, DDT, 41 MH, 4 XP (2)
Model 700 ..	MVSG, MVSG, 41 MHL, MVSG, DDT, 4 XP, 460 BU
Model 703 ..	*MVSG, *MVSG, 41 MHL, *MVSG, *DDT, 4 XP, 442 BU
Model 1202 ..	*MVSG, *MVSG, 41 MHL, *MVSG, *DDT, MSG/HA, 41 MH, 41 MH, 41 MH, 4 XP (2), 460 BU
Model 1203 ..	*MVSG, *MVSG, *MS/Pen, *MVSG, *DDT, *MS/Pen, 41 MH, 41 MH, 41 MH, 4 XP (2), 460 BU

**Radio Instruments, Ltd.**

R.I. Madrigal 3 ..	MSG/HA, 41MHL, PT 41 B, 442 BU
R.I. Madrigal A.C.3 ..	MSG/LA, 41 MHL, MP/Pen
R.I. Madrigal Class B 4 ..	220 VS, 210 Det, 210 LF, 220 B
R.I. Madrigal Superhet Radiogram ..	*MSG/HA, MVS/Pen, 41 MHL (2), MP/Pen, 442 BU
R.I. Receiver with Cocktail Bar	MSG/LA, 41 MH, MP/Pen
Micrion Battery 3 ..	*210 VPT, *210 HF, 220 HPT
Ritz Mains Superhet ..	_____, *MVS/Pen, _____, MP/Pen
Ritz Airflo. A.C. ....	_____, *MVS/Pen, _____, MP/Pen
Ritz Twin Speaker ..	_____, *MVS/Pen, _____, MP/Pen
R.I. Micrisonic ..	_____, *MS/Pen, 42 MP/Pen, 442 BU

**Ready Radio.**

Meteor 3 ..	210 HL, 210 LF, 220 P
Mains Radio G ..	41 MH, 41 MHL, 41 MXP
Model AY35, A.C.4 ..	*MVS/Pen, 41 MH, MP/Pen
303 Kit ..	210 Det, 210 LF, 220 P
Meteor S.G.3 ..	*215 SG, 210 HF, 220 P
S.G.4 Kit ..	*215 SG, 210 HL, 210 Det, 220 P
Everyman 4 ..	MVS/Pen, *41 MH, MP/Pen
Everyman Plus 4 ..	*220 SG, 210 HL, 210 Det, 230 XP

**Regent Radio Supply Co.**

Regentone 4-valve A.C. ..	41 MSG, 41 MSG, 41 MHF, 41 MP
Regentone 2-valve A.C. ..	41 MH, 41 MP
Regentone Quadradyne Band Pass 4 ..	MVS/Pen, 41 MH, MP/Pen
Regentone Quadradyne 5 ..	MVS/Pen, MVS/Pen, MS/Pen, MP/Pen
Regentone Superhet 5 ..	MS/Pen (2), MVS/Pen, MP/Pen
Regentone Quadradyne Class B 5 ..	220 VS, 210 HL, 220 PA, 220 B
Regentone Battery 3 ..	*220 VS, *210 HF, 220 HPT
Regentone Straight 3 ..	MVSG, *41 MH, PT 41
Regentone Super 3 ..	MVSG, *41 MH, MP/Pen
Regentone Quadradyne ..	MVSG (2), MSG/HA, MP/Pen
Regentone Quadradyne 4 ..	MVSG (2), *MS/Pen, MP/Pen
Regentone Quadradyne 5 ..	MS/Pen, *MS/Pen, MVS/Pen, MP/Pen
Battery Superhet ..	210 SPT, 210 VPT, _____, 220 HPT

**Rolls Radio (Consolidated Radio Co., Ltd).**

Rolls Super Phantom Portable	215 SG, 215 SG, 210 RC, 230 PT
Rolls Baby Phantom Portable	215 SG, 210 RC, 210 HF, 230 XP
Rolls-Caydon S.G.4 ..	220 SG, 210 HF (2), 220 PA
Ranger S.G.3 ..	*220 VS, *210 HF, 220 HPT
Ranger Junior Suitcase 4 ..	*220 VS, *210 HF, 210 LF, 220 PA
Cam. A.C. Radiogram ..	*MSG/HA, 41 MH, MP/Pen
Gnome Portable ..	215 SG, 210 HF (2), 220 PA
Ranger Junior ..	210 HL, 210 LF, 220 B
Rees-Mace Table R.G. ..	*MSG/LA, *41 MH, MP/Pen
Rolls-Caydon Transportable S.G. 4 ..	215 SG, 210 HF (2), 220 PA
Rolls-Caydon A.C. Band Pass 3 ..	MSG/HA, 41 MH, MP/Pen
Rolls-Caydon A.C. 3 ..	MSG/LA, 41 MH, MP/Pen

**Scottish C.W.S.**

Unitone B.95	..	..	*210 HF, 210 LF, 220 PA
Unitone B.110	..	..	*210 HF, 210 LF, 220 HPT
Unitone B.147	..	..	*220 SG, *210 HF, 220 HPT
Unitone B.160	..	..	*220 SG, *210 HF, 220 HPT
Unitone B.261	..	..	*210 VPT, *210 PG, *210 VPT, _____, _____
Unitone A.210	..	..	*MVS/Pen, *MS/Pen, 42 MP/Pen
Unitone A.252	..	..	_____, _____, *MS/Pen, MP/Pen
Unitone A.273	..	..	_____, _____, *MS/Pen, MP/Pen

**Standard Telephones & Cables, Ltd.**

Standard 40	..	..	MS/Pen, MVS/Pen, MP/Pen
Standard 30B	..	..	215 SG, 210 HL, 220 HPT
Standard S322	..	..	41 MH, MP/Pen
Standard S328	..	..	210 HL, 220 HPT
Standard 60	..	..	MS/Pen, MVS/Pen (2), DDT, MP/Pen
Standard 30 MC	..	..	220 SG, 210 HF, 220 HPT

**Telsen Electric Co., Ltd.**

Victor 3	..	..	*210 HF, 210 LF, 230 XP
Air-Marshall 3	..	..	210 HL, 210 LF, 230 XP
Models 464, 470, 474	..	..	MS/Pen, 41 MHF, MP/Pen
Class B Kit	..	..	220 SG, 210 HL, 220 PA, 220 B
Astrala 3 Kit	..	..	*210 HF, 210 LF, 220 PA
Conqueror 3	..	..	210 HF, 210 LF, 220 P
Short-Wave 3	..	..	210 Det, 210 LF, 220 P
Triple 3	..	..	*210 HF, 210 Det, 220 P (or 230 XP)
Ajax 3	..	..	210 HF, 210 LF, 220 P
Astrala 3	..	..	210 HF, 210 LF, 220 P
Commodore 3	..	..	*220 SG, 210 Det, 220 PA (or 220 HPT or 220 PT)
Jupiter 3	..	..	*220 SG, *210 HF, 220 HPT (or 220 PT)
Empire Four	..	..	*220 SG, 210 HF, 210 Det, 220 P, 230 XP
Super Selective Four	..	..	*215 SG (2), 210 HF, 220 HPT (or 220 PT)
Air Marshall Four	..	..	*220 SG, *210 HF, 210 Det, 220 P (or 230 XP)
Super Six	..	..	*220 VSG (2), 215 SG, 210 HF (2), 220 HPT (or 220 PT)
Models S91, S92 & S93	..	..	*210 HF, 210 Det, 220 P (or 230 XP)
Macnamara	..	..	*MSG/HA, *41 MH, MP/Pen, 442 BU
Short Wave 3 (1934)	..	..	*220 SG, *210 HL, 220 HPT (or 220 PT)
3-valve Economy Receiver	..	..	*220 SG, *210 HL, 220 PT
Model 3435/MV	..	..	MVS/Pen, _____, MVS/Pen, DD4, 42 MP/Pen, _____
Model 3435/MH	..	..	MVS/Pen, _____, MVS/Pen, DD4, 42 MP/Pen, _____
Model 1240 R.G.	..	..	MS/Pen, MS/Pen, 42 MP/Pen, _____
Models 3550 R.G. & R.G.A.	..	..	MVS/Pen, _____, MVS/Pen, DD4, 42 MP/Pen, _____
Model 3435/BV	..	..	210 VPT, 210 PG, 210 VPT, _____, 210 LF, _____
Model 3435 BH	..	..	210 VPT, 210 PG, 210 VPT, _____, 210 LF, _____
Model 474 A.C.	..	..	MS/Pen, 42 MP/Pen, _____

**Ultra Electric, Ltd.**

Twin Cub	..	..	41 MHL, 415 PT, 408 BU
Tiger 3	..	..	MSG/LA, MSG/LA, MP/Pen, 442 BU
Portable 5	..	..	210 HL, 210 HL, 210 HL, 210 HL, 215 P
Lynx	..	..	MVSG, MSG/LA, MP/Pen
Tiger ..	..	..	MSG/LA (2), MVSG, MP/Pen
Panther	..	..	MSG/LA (2), MVSG (2), DDT, MP/Pen
Tiger, Class B	..	..	215 SG, 220 VS, 210 HL, 210 LF, 220 B
66 A.C.	..	..	MVS/Pen, MS/Pen, 42 MP/Pen, _____
77	..	..	210 VPT, 210 SPT, 220 HPT

**Varley Radio.**

Junior D.C.	..	..	610 LF, 610 P, 610 XP
Junior A.C.	..	..	41 MHF, 41 MP, 412 SU
Senior D.C.	..	..	MSG/HA, 41 MHF, 41 MXP
Senior A.C.	..	..	MSG/HA, 41 MHF, 41 XP
Square Peak 3	..	..	MSG/HA, 41 MH, MP/Pen, 442 BU
Square Peak 4	..	..	MS/Pen, MVS/Pen, 41 MH, MP/Pen, 442 BU
Square Peak Mains Superhet	..	..	MS/Pen, MVS/Pen (2), 41 MH, MP/Pen, 442 BU

# USEFUL CIRCUITS

The following pages of useful circuits can be divided into several classes, sections of circuits illustrating some fundamental principles, couplings, and complete circuits.

It is particularly emphasized that these schematic circuits contain various tentative values which in all probability will not hold good in practice as the values of components are largely influenced by the actual layout and components selected.

## H.F. CIRCUITS

### AERIAL COUPLING

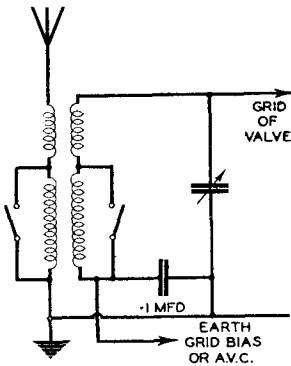

(1) **Aerial Transformer** (Standard arrangement). Input to grid is considerably smaller at upper end of each waveband than at lower.

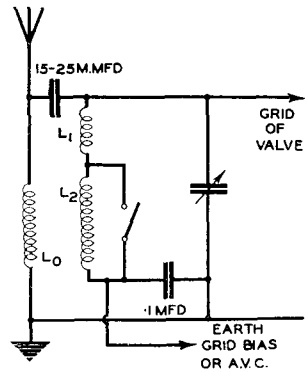

(2) **Combined Coupling.**  $L_0$  has about two-third turns of  $L_1$ , is closely coupled to  $L_1$  and very loosely coupled to  $L_2$ . Gives roughly level response over M.W. band. Note absence of primary switching.

### TYPES OF FILTER

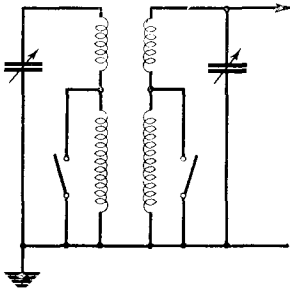

(1) **Coupled by mutual inductance between coils.** Satisfactory, but difficult to design.

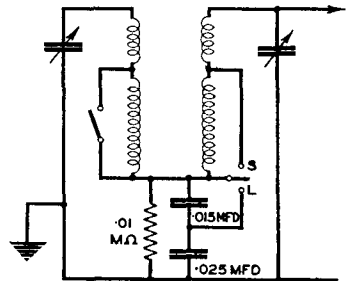

(2) **Coupled by common capacity.** Note that a change-over switch is used to cut out upper condenser on long waves. Exact values of condensers depend on coil resistances.



# H.F. CIRCUITS (continued)

## H.F. COUPLINGS

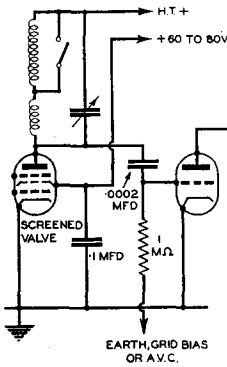

(1) Tuned Anode. (Standard form).

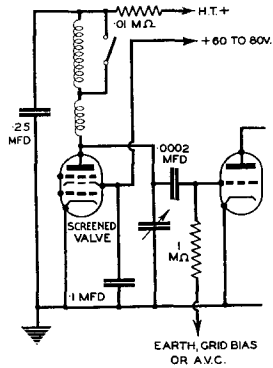

(2) Tuned Anode. Re-arranged for gang condenser, where moving plates must be earthed.

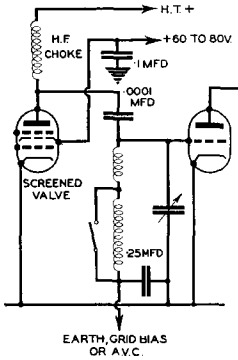

(3) Tuned Grid Circuit. Provided the H.F. Choke is a good one, all these three circuits give practically identical results.

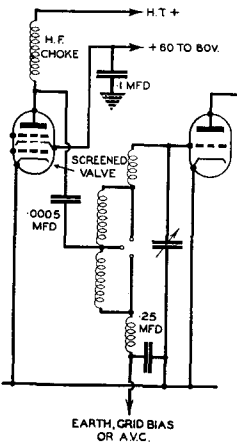

(4) Tuned Grid, tapped independently on both wave bands. May readily be adapted to tuned anode, either standard or as circuit 2. The tap improves selectivity at the cost of amplification.

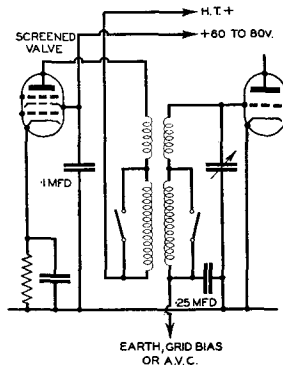

(5) Transformer Coupling. This is generally more free from unwanted feed-back, whether at high or low frequencies, than any other coupling.

There are innumerable variations, in detail, of all these circuits.

# FREQUENCY CHANGERS

(1) A particularly satisfactory 2-valve frequency changer suitable for all wavelengths. C1 and C2 are padding condensers.

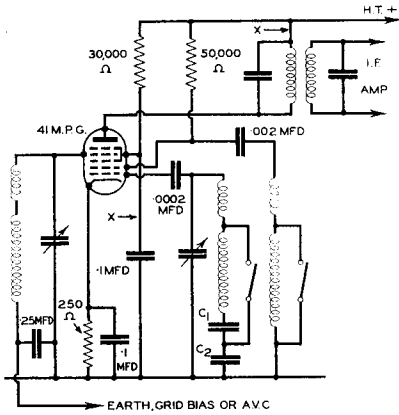
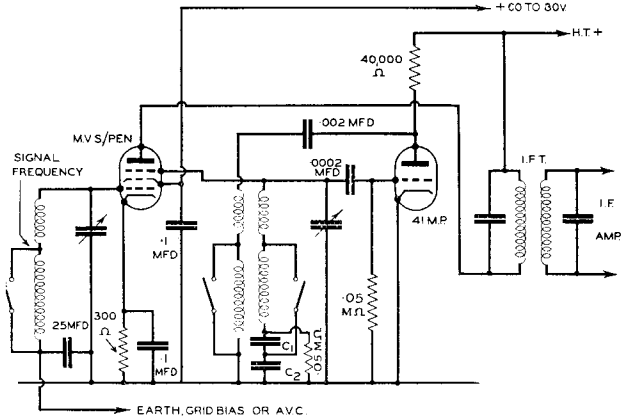

(2) Single-valve frequency changer using a pentagrid. To prevent parasitic oscillation, it is often found desirable to insert a short-wave choke (12 turns of wire,  $\frac{3}{8}$ " diameter) at each of the two points X.

Except that a single valve is used, the circuit is in all essentials identical with (1).

Not suitable for ultra-short waves.

(3) Frequency-changer for ultra-short waves. Consists, fundamentally, of a pentagrid as mixer valve and a 41 M.P. as a separate oscillator.

It is extremely satisfactory also on medium and long waves, but for this use the .01 mica bypass condensers should be replaced by 0.1 paper condensers. Both types, in parallel, should be used in an all-wave set.

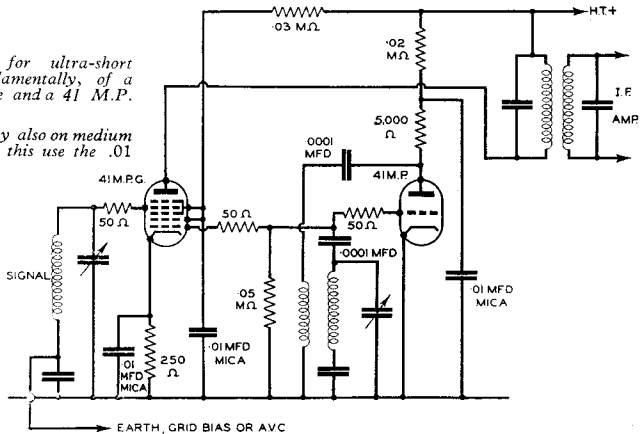

# DETECTION

## A—IN STRAIGHT SETS

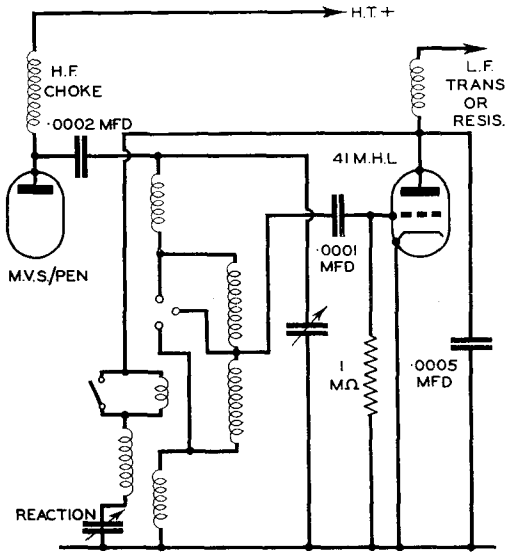

(1) This is probably the best input circuit to a grid detector. Note that the grid is taken to a tap in the tuned coil—half-tap is about right with an average coil. Tuned-grid circuit is shown, but tuned-anode or transformer is equally suitable. Reaction-turns, as always, must be found by experiment. A screened valve which must be resistance coupled, gives roughly the same sensitivity as a triode followed by a 3 : 1 transformer.

## B—IN SUPERHETS or where large signals are available for detection.

(1) Is suitable for "straight" sets, where tuning condenser must be earthed. H.F. choke may often be replaced with 0.1 megohm resistance.

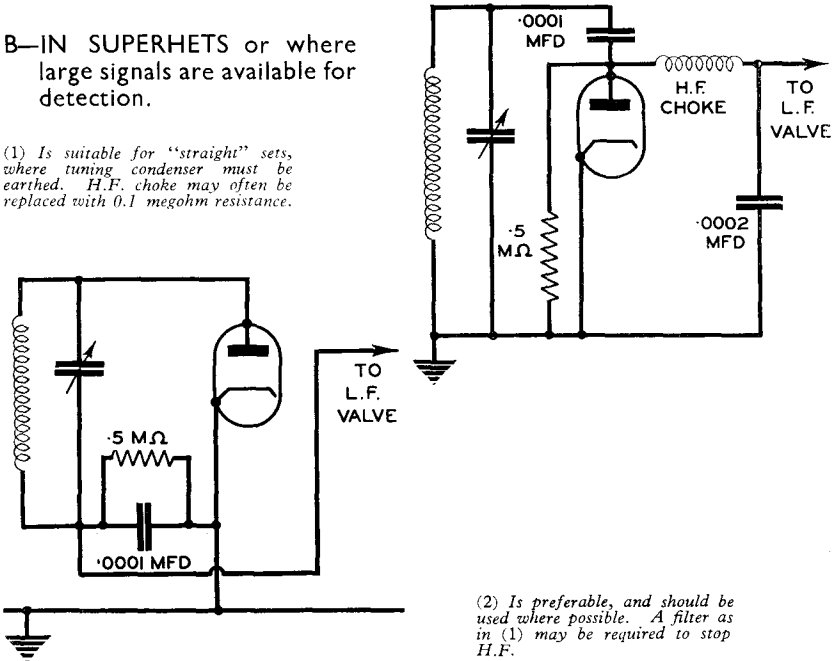

(2) Is preferable, and should be used where possible. A filter as in (1) may be required to stop H.F.

# DETECTION with A.V.C.

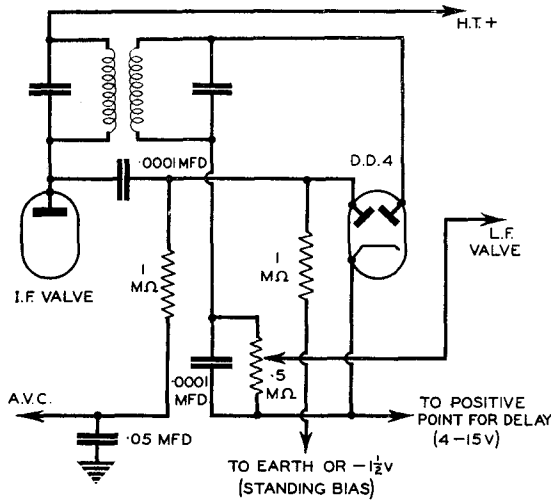

(1) Simple circuit for delayed A.V.C. and detection. Delay voltage should be adjusted so that output valve is just overloaded (on fairly distant station) with volume control at maximum.

(2) Circuit as (1) for detection and A.V.C., but using D.D.T. to provide L.F. amplification in addition. Delay,  $1\frac{1}{2}$  to 2 volts only. Extra delay, if required, may be had by taking leak A to point negative with respect to earth, or by raising entire system, except A, a few volts positive.

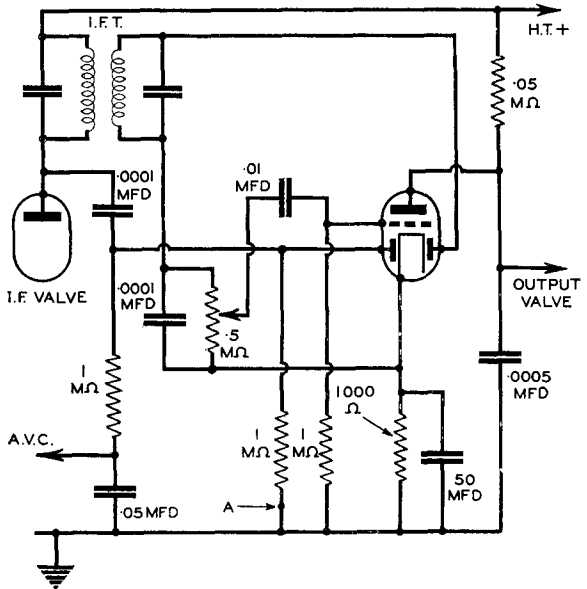

## DETECTION with A.V.C. (continued)

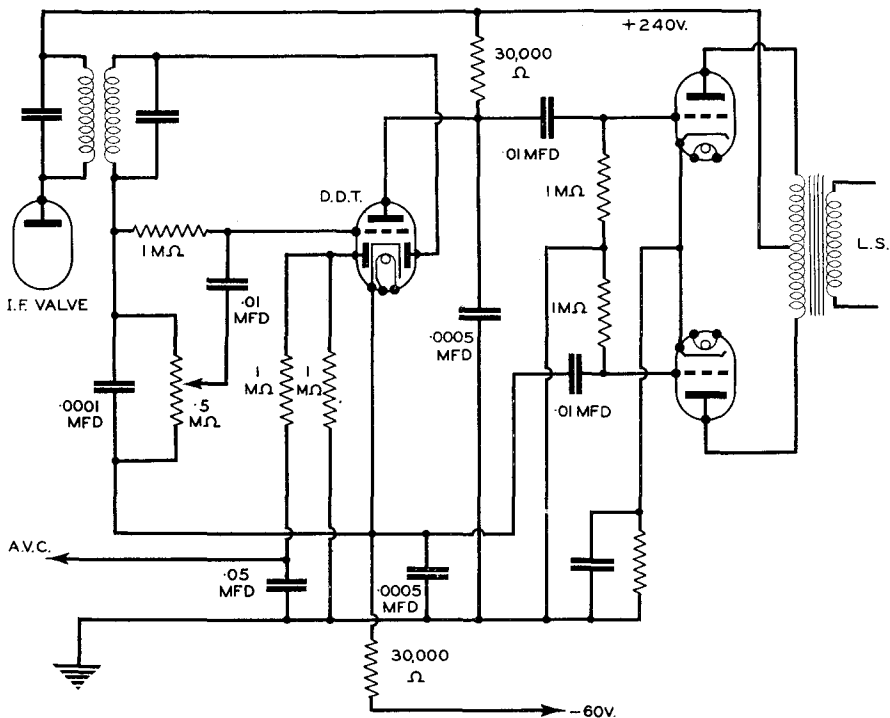
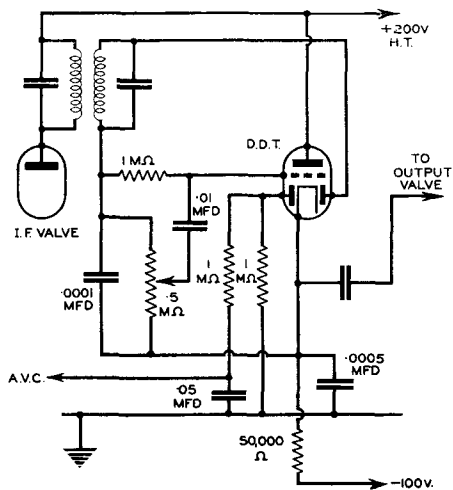

(4) As circuit (3), but with "split" output to feed a pair of valves in push-pull. Note that A.V.C. is a little less perfect, since half the A.V.C. voltage is lost.

# COMPLETE CIRCUIT OF 4-VALVE SUPERHET WITH DELAYED A.V.C.

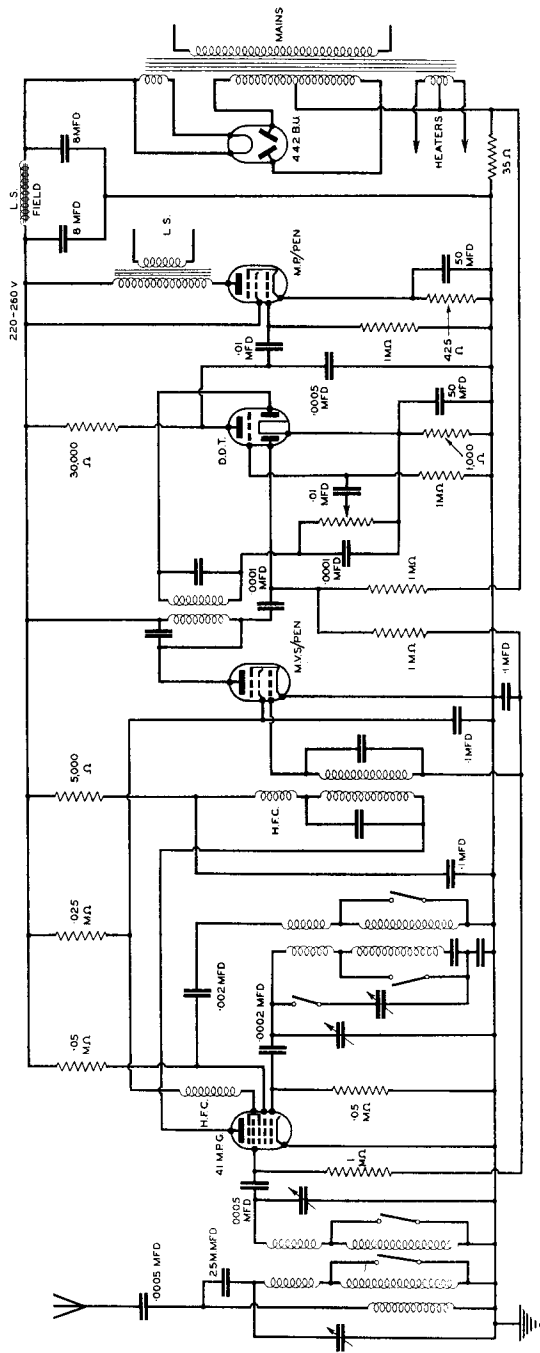

*Chokes "H.F.C." in anode and screen circuits of 41 M.P.C. are each 12 turns of wire,  $\frac{3}{8}$ " diameter.*







# COMPLETE 6-WATT AMPLIFIER FOR GRAMOPHONE RECORDS

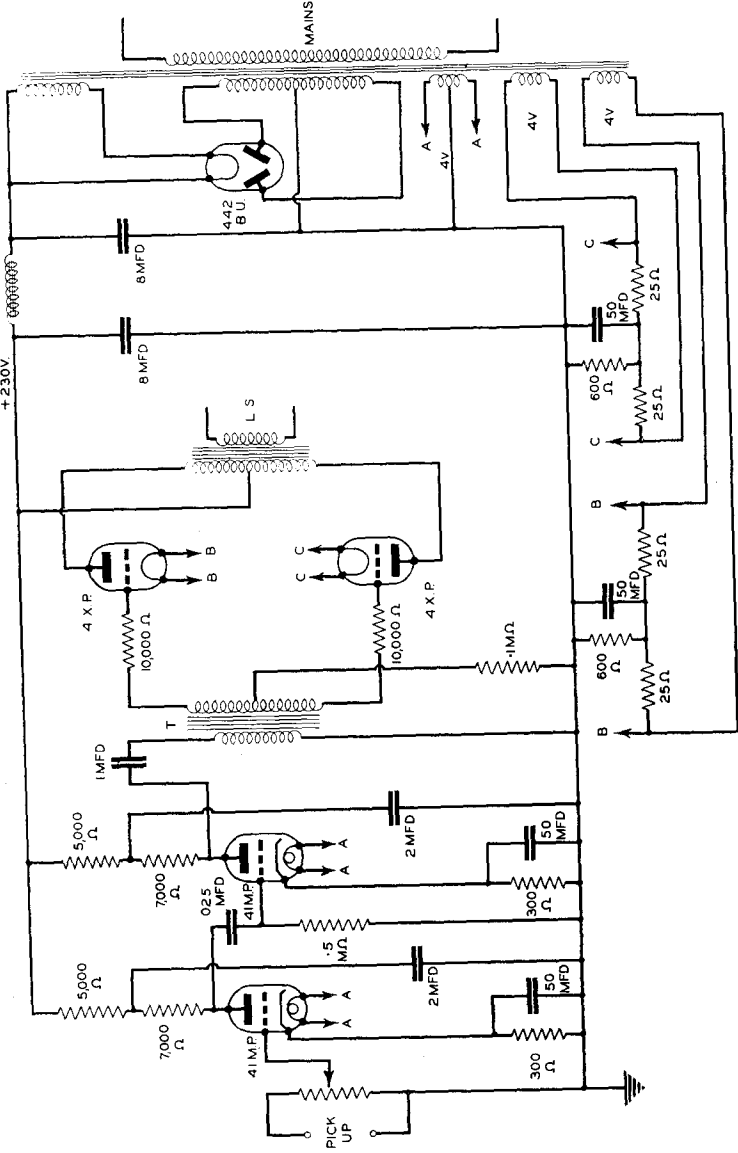

Note separate bias on output valves. Transformer must not be metal type; choose a 3:1 alloy-cored transformer of reliable quality and fair size.

**PRICE LIST**

**OF**

**COSSOR  
VALVES**

Oct., 1935

# PRICE LIST OF

Type	Bulb	Pins	Purpose	Price	Page
<b>2-VOLT TYPES</b>					
215 S.G.	Clear	4	Screened Grid .. .. .	12/6	48
	Metallised	4	do. .. .. .		
220 S.G.	Clear	4	Screened Grid .. .. .	12/6	49
	Metallised	4	do. .. .. .		
220 V.S.G.	Clear	4	Variable- $\mu$ Screened Grid .. .. .	12/6	46
	Metallised	4	do. .. .. .		
220 V.S.	Clear	4	Variable- $\mu$ Screened Grid .. .. .	12/6	45
	Metallised	4	do. .. .. .		
210 V.P.T.	Metallised	4	Variable- $\mu$ H.F. Pentode .. .. .	13/6	44
	Clear	7	do. .. .. .	"	"
	Metallised	7	do. .. .. .	"	"
210 S.P.T.	Metallised	4	H.F. Pentode .. .. .	13/6	47
	Clear	7	do. .. .. .		
210 P.G.	Metallised	7	Pentagrid .. .. .	18/6	50
220 D.D.	Clear	4	Double Diode .. .. .	5/6	51
210 D.G.	Clear	5	Bigrid .. .. .	20/-	104
210 R.C.	Clear	4	R.C.C. or Detector .. .. .	5/6	52
210 H.L.	Clear	4	H.F. or Detector .. .. .	5/6	53
	Metallised	4	do. .. .. .		
210 H.F.	Clear	4	H.F. Detector, or L.F. .. .. .	5/6	54
	Metallised	4	do. .. .. .		
210 DET.	Clear	4	Special Detector .. .. .	5/6	55
	Metallised	4	do. .. .. .		
210 L.F.	Clear	4	First L.F. Stage .. .. .	5/6	56
215 P.	Clear	4	Normal Power Use .. .. .	7/-	57
220 P.	Clear	4	do. .. .. .	7/-	58
220 P.A.	Clear	4	do. .. .. .	7/-	59
230 X.P.	Clear	4	Extra Power .. .. .	12/-	60
220 P.T.	Clear	4	Output Pentode .. .. .	13/6	64
	Clear	5	do. .. .. .		
220 H.P.T.	Clear	4	Economy Output Pentode .. .. .	13/6	63
	Clear	5	do. .. .. .		
230 P.T.	Clear	4	Output Pentode .. .. .	16/6	107
	Clear	5	do. .. .. .		
220 B.	Clear	7	Class "B" Output .. .. .	14/-	62
240 B.	Clear	7	do. .. .. .	14/-	61
<b>4-VOLT TYPES</b>					
410 S.G.	Clear	4	Screened Grid .. .. .	20/-	103
410 R.C.	Clear	4	R.C.C. or Detector .. .. .	8/6	105
410 H.F.	Clear	4	H.F. Detector, or L.F. .. .. .	8/6	"
410 L.F.	Clear	4	First L.F. Stage .. .. .	8/6	"
410 P.	Clear	4	Normal Power Use .. .. .	10/6	106
415 X.P.	Clear	4	Extra Power .. .. .	13/6	"
425 X.P.	Clear	4	do. .. .. .	13/6	"
415 P.T.	Clear	4	Output Pentode .. .. .	17/6	107
	Clear	5	do. .. .. .		
410 P.T.	Clear	4	Output Pentode .. .. .	17/6	"
	Clear	5	do. .. .. .		
<b>6-VOLT TYPES</b>					
610 S.G.	Clear	4	Screened Grid .. .. .	20/-	103
610 R.C.	Clear	4	R.C.C. or Detector .. .. .	8/6	105
610 H.F.	Clear	4	H.F., Detector, or L.F. .. .. .	8/6	"
610 L.F.	Clear	4	First L.F. Stage .. .. .	8/6	"
610 P.	Clear	4	Normal Power Use .. .. .	10/6	106
610 X.P.	Clear	4	Extra Power .. .. .	13/6	"
625 P.	Clear	4	Super Power .. .. .	13/6	"
615 P.T.	Clear	4	Output Pentode .. .. .	17/6	107
<b>NEON STABILIZER</b>					
S.130	Clear	4	Voltage Stabilizer .. .. .	7/6	99
<b>NEON TUNING INDICATOR</b>					
3180	S.B.C. Base		Tuning Indicator .. .. .	4/-	99
3184	Miniature 4-pin Base		do. .. .. .	4/-	"
<b>SPECIAL POWER VALVES</b>					
680 H.F.	Clear	4	First L.F. Amplifier .. .. .	25/-	—
680 P.	Clear	4	Power Amplifier .. .. .	25/-	—
680 X.P.	Clear	4	do. .. .. .	25/-	—
620 T.	Clear	4	do. .. .. .	30/-	—
4 X.P.	Clear	4	do. .. .. .	16/6	77
660 T.	Clear	4	do. .. .. .	105/-	—

*Prices subject to*

# COSSOR VALVES

Type	Bulb	Pins	Purpose	Price	Page
<b>INDIRECTLY HEATED MAINS VALVES</b>					
<b>(4-volt 1.0 amp. Series)</b>					
M.S.G./H.A.	Clear	5	Super H.F. Amplification .. ..	17/6	69
"	Metallised	5	do.	"	"
41 M.S.G.	Clear	5	Super H.F. Amplification .. ..	17/6	103
"	Metallised	5	do.	"	"
M.S.G./L.A.	Clear	5	Super H.F. Amplification .. ..	17/6	70
"	Metallised	5	do.	"	"
M.V.S.G.	Clear	5	Variable-mu Screened Grid .. ..	17/6	67
"	Metallised	5	do.	"	"
M.S./Pen.	Clear	5	H.F. Pentode .. ..	17/6	68
"	Metallised	5	do.	"	"
"	Metallised	7	do.	"	"
M.V.S./Pen.	Metallised	5	Variable-mu H.F. Pentode .. ..	17/6	66
"	Metallised	7	do.	"	"
M.S./Pen.-A.	Metallised	5	H.F. Pentode .. ..	17/6	102
41 M.P.G.	Metallised	7	Pentagrid .. ..	20/-	71
41 M.D.G.	Clear	5	Bigrid .. ..	19/-	104
"	Metallised	5	do.	"	"
41 M.R.C.	Clear	5	R.C.C. or Detector .. ..	14/-	105
41 M.H.	Clear	5	Detector .. ..	13/6	75
"	Metallised	5	do.	"	"
41 M.H.F.	Clear	5	H.F. or Detector .. ..	14/-	105
"	Metallised	5	do.	"	"
41 M.H.L.	Clear	5	Detector or L.F. .. ..	13/6	76
"	Metallised	5	do.	"	"
41 M.L.F.	Clear	5	Low Frequency .. ..	14/-	105
D.D.4	Clear	5	Double Diode (Heater .75 amp.) ..	5/6	72
D.D.T.	Metallised	7	Double Diode Triode (A.V.C.) ..	15/6	73
D.D./Pen.	Metallised	7	Double Diode Pentode (A.V.C.) ..	20/-	74
41 M.P.	Clear	5	Normal Power .. ..	14/-	78
41 M.X.P.	Clear	5	Extra Power .. ..	16/6	79
M.P./Pen.	Clear	5	Pentode Power Output .. ..	18/6	80
"	Clear	7	do.	"	"
42 M.P./Pen.	Clear	7	(2 amps. heater) Pen. Power Output	18/6	81
<b>(16-volt .25 amp. Series)</b>					
D.V.S.G.	Metallised	5	Variable-mu Screened Grid .. ..	17/6	93
D.H.L.	Metallised	5	Detector or L.F. .. ..	13/6	96
D.P./Pen.	Clear	7	Pentode Power Output .. ..	18/6	98
D.P.	Clear	5	Triode Power Output .. ..	14/-	97
D.V.S./Pen.	Metallised	5	Variable-mu H.F. Pentode .. ..	17/6	92
D.S./Pen.	Clear	5	H.F. Pentode .. ..	17/6	94
"	Metallised	5	do.	"	"
D.D.T. 16	Metallised	7	Double Diode Triode (A.V.C.) ..	15/6	95
<b>(.2 amp. Series)</b>					
13 D.H.A.	Clear	7	Double Diode Triode .. ..	15/6	88
13 V.P.A.	Clear	7	Variable-mu H.F. Pentode .. ..	17/6	85
"	Metallised	7	do.	"	"
13 S.P.A.	Clear	7	H.F. Pentode .. ..	17/6	86
"	Metallised	7	do.	"	"
13 P.G.A.	Clear	7	Pentagrid .. ..	20/-	87
40 P.P.A.	Clear	7	Pentode Power Output .. ..	18/6	90
402 P.	Clear	5	Output Triode .. ..	16/6	89
40 S.U.A.	Clear	5	Half Wave Rectifier .. ..	12/6	101
<b>DIRECTLY HEATED MAINS VALVES</b>					
<b>(4-volt 1.0 amp. Series)</b>					
P.T. 41	Clear	5	Power Pentode Output .. ..	18/6	82
P.T. 41B.	Clear	5	do.	22/6	83
4X.P.	Clear	4	Power Amplifier .. ..	16/6	77
<b>STANDARD RECTIFIERS</b>					
506 B.U.	Clear	4	Full Wave .. ..	12/6	100
442 B.U.	Clear	4	do.	15/-	"
460 B.U.	Clear	4	do.	20/-	"
40 S.U.A.	Clear	5	Half Wave .. ..	12/6	101
<b>RECTIFIERS (for Replacements)</b>					
44 S.U.	Clear	4	Half Wave .. ..	15/-	101
412 S.U.	Clear	4	do.	15/-	"
660 S.U.	Clear	4	do.	63/-	"
408 B.U.	Clear	4	Full Wave .. ..	12/6	"
612 B.U.	Clear	4	do.	20/-	"
412 B.U.	Clear	4	do.	20/-	"
624 B.U.	Clear	4	do.	20/-	"
825 B.U.	Clear	4	do.	22/6	"

alteration without notice.