

ELECTRONIC SYSTEMS

ADDITIONAL INFORMATION

The JOSLYN Story

During the early and middle 1950's, the Protective Equipment Department of Joslyn Mfg. and Supply Co., Chicago, Illinois, manufactured a product which at that time was little more than a laboratory curiosity. This product is the airborne hf antenna lightning arrester. Joslyn protection engineers, working with Lightning and Transient Research Institute of Minneapolis and also the electronic engineers of several airlines, created this prototype product to protect various airplane antennae and associated communications equipment which are very vulnerable to lightning strikes.

During the period 1953-1957, the annual sales of this product were extremely modest. By 1958, however, industry developments in avionics and related antenna technology created sufficient growth potential in the product area to warrant an investment of human and financial resources. On April 11, 1958, Mr. P. W. Lotz, then President of Joslyn Mfg. and Supply Co., announced the formation of the Aircraft Lightning Arrester Department which continued as a part of the Protective Equipment Division of Joslyn.

On January 1, 1964, this Department became a Division of Joslyn, now known as Joslyn Electronic Systems. On February 1, 1965, the Division moved its equipment and personnel from Chicago to Goleta, California, to pursue its business in a new 17,000 square foot plant and laboratory building in the Santa Barbara Research Park, lo-

cated eight miles west of downtown Santa Barbara. A 42,000 square foot addition to our present facilities was completed in September 1969 providing for expanded operations in production, engineering and administration.

Basically, our business is the design and manufacture of sophisticated transient suppression devices wherever they are required in electrical and electronic circuits. Known the world over as the leading supplier of aircraft lightning protection, Joslyn Electronic Systems is rapidly gaining a similar reputation for electrical surge and transient protection in the fields of power, communications, transportation and industrial process control.

Laboratory Facilities

The Joslyn laboratory facilities include a series of high-voltage and high-current surge generators capable of: simulating lightning stroke currents far in excess of MIL-A-9094D requirements, standard and special voltage and current wave shapes and heavy coulomb discharge. Other laboratory facilities include a 1.25 megajoule capacitor bank; environmental test chamber; high-voltage RF and DC power supplies; 8,000 A. 100-1000 V, 3 ϕ , 60 Hz power system; 50 kW, 120/208 V, 3 ϕ , 400 Hz power system; mass spectrometer leak detection equipment, and oscillographic equipment for measuring and recording fast rise time, high voltages and currents.



MSP® applies to two-element miniature surge protectors.



TRIGARD® applies to three-element precision spark gaps.

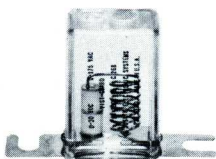

VISI-GUARD® applies to communication and signal protectors incorporating as one of the components a three-element precision spark gap.

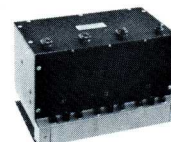

SURGITRON® applies to AC and DC power systems surge protectors.

TRADE NAMES

ELECTRONIC SYSTEMS DIVISION

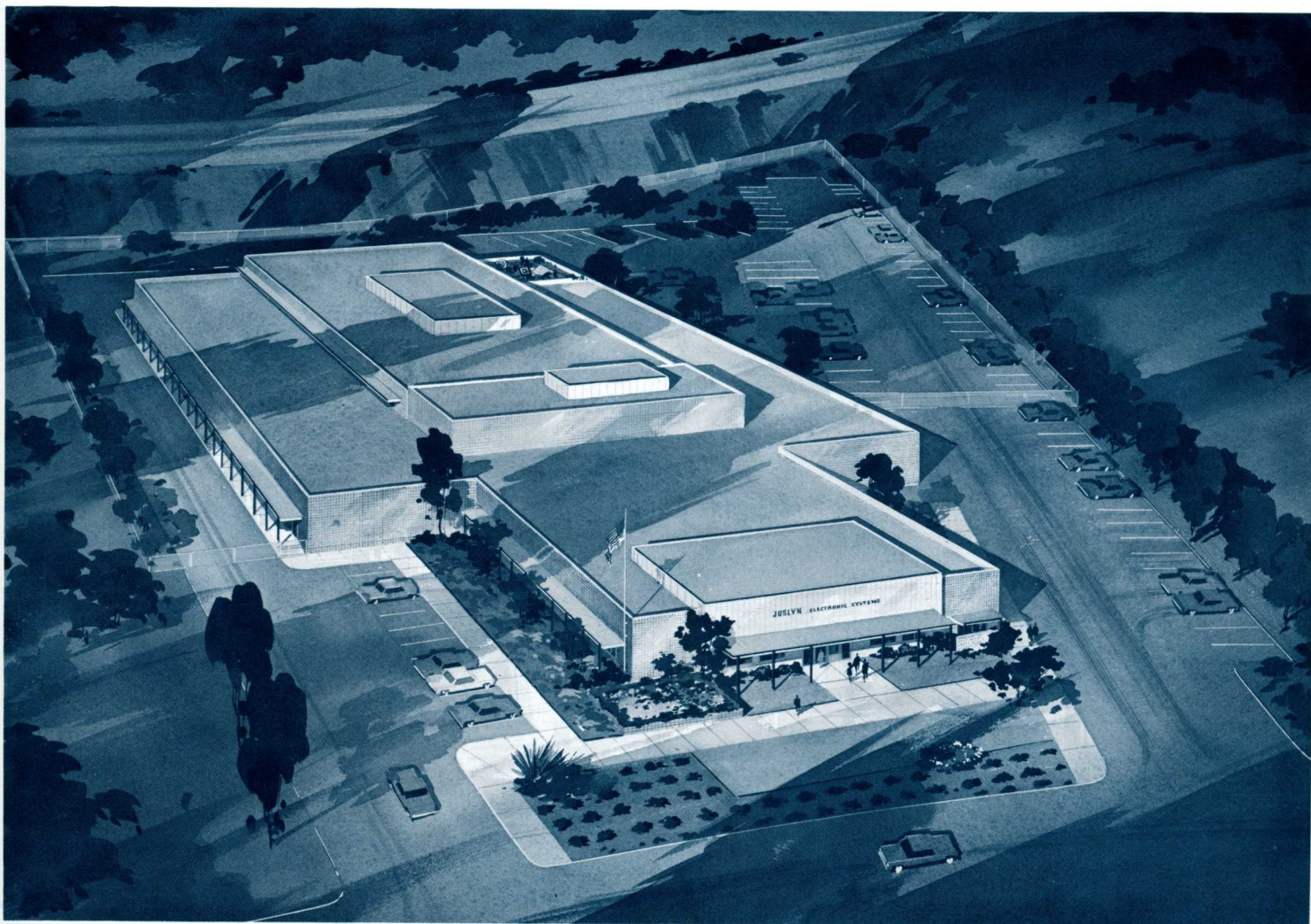

Systems protection in nuclear and space age environments

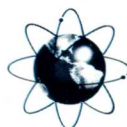

ELECTRONIC SYSTEMS DIVISION

Division of Joslyn Manufacturing and Supply Co.

6868 Cortona Drive, Santa Barbara Research Park
Post Office Box 817, Goleta, California 93017
Phone: (805) 968-3551, Telegram: Joslectron, Goleta

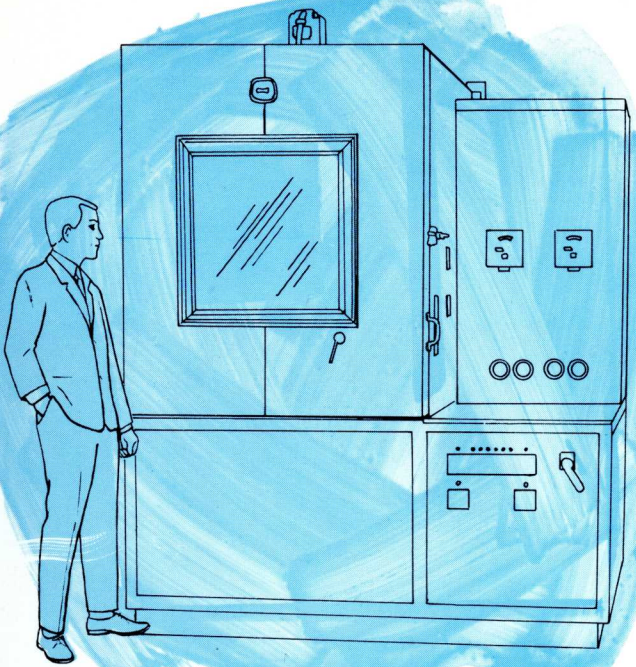

The environmental chamber is used for the testing of Joslyn products under extremes of temperature and humidity.

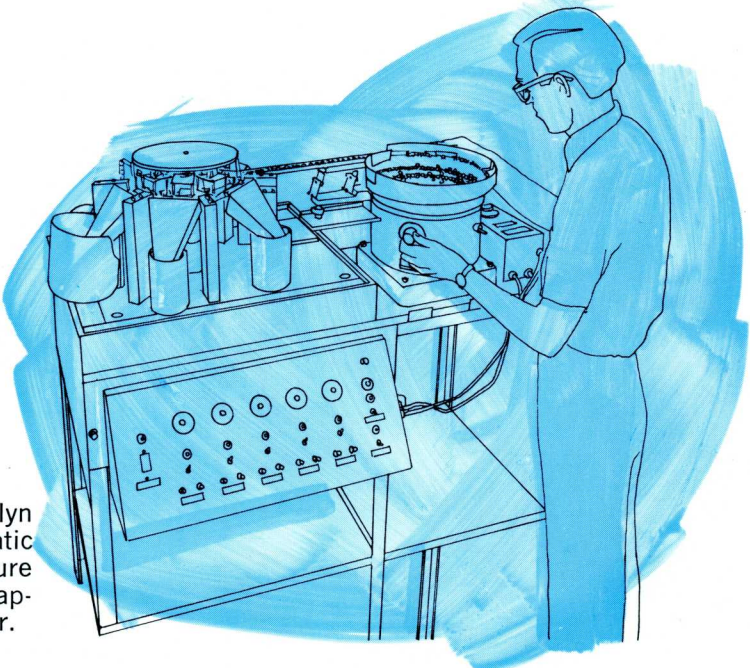

The "merry-go-round" is a Joslyn designed device for the automatic testing and sorting of miniature surge protectors. Its capacity is approximately 2,500 MSP's per hour.

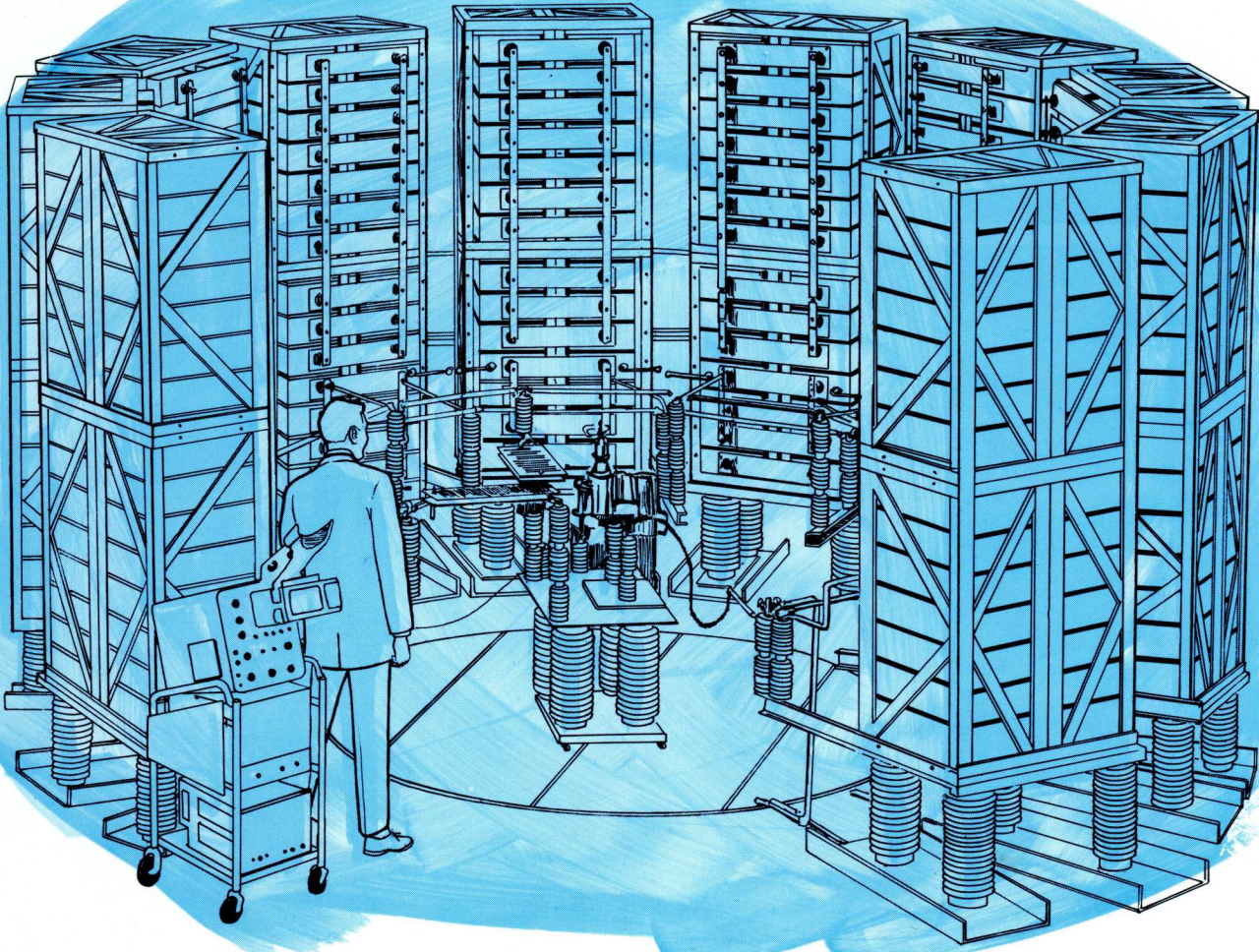

The 1.25 megajoule capacitor bank is the heart of the Joslyn surge generator capable of testing in excess of MIL-A-9094D. This surge generator also includes a Q-bank and a battery bank (not pictured) for the extended tail portions of the lightning stroke. The present maximum rating is 400,000 peak amperes at 460,000 peak volts.



JOSLYN ELECTRONIC SYSTEMS

Division of Joslyn Mfg. and Supply Co.

PRICE LIST • 1 December 1970

Model Number DC PROTECTORS

	1-24 Pieces	25-49 Pieces	50-99 Pieces	100-499 Pieces
1012-01	\$ 68.00 each	\$ 58.00	\$ 50.00	\$ 44.00
1013-01	350.00	330.00	310.00	290.00
1013-02	350.00	330.00	310.00	290.00
1013-03	350.00	330.00	310.00	290.00
1014-01	350.00	330.00	310.00	290.00
1014-02	350.00	330.00	310.00	290.00
1014-03	350.00	330.00	310.00	290.00
1015-01	350.00	330.00	310.00	290.00
1015-02	350.00	330.00	310.00	290.00
1015-03	350.00	330.00	310.00	290.00
1016-01	350.00	330.00	310.00	290.00
1016-02	350.00	330.00	310.00	290.00
1016-03	350.00	330.00	310.00	290.00
1017-01	350.00	330.00	310.00	290.00
1017-02	350.00	330.00	310.00	290.00
1017-03	350.00	330.00	310.00	290.00

AC PROTECTORS SINGLE PHASE

	1-24 Pieces	25-49 Pieces	50-99 Pieces	100-499 Pieces
1201-02	\$ 330.00 each	\$ 310.00	\$ 295.00	\$ 285.00
1230-01	150.00	140.00	130.00	125.00
1235-01	250.00	235.00	220.00	210.00
1240-01	500.00	465.00	440.00	425.00
1245-01	900.00	850.00	810.00	775.00
1250-01	25.00	23.50	22.00	21.00

AC PROTECTORS THREE PHASE

	1-24 Pieces	25-49 Pieces	50-99 Pieces	100-499 Pieces
1405-02	\$ 300.00 each	\$ 280.00	\$ 265.00	\$ 250.00
1414-02	1,100.00	1,030.00	970.00	930.00
1414-06	1,100.00	1,030.00	970.00	930.00
1414-08	1,350.00	1,275.00	1,200.00	1,150.00
1414-09	1,350.00	1,275.00	1,200.00	1,150.00
1414-10	1,350.00	1,275.00	1,200.00	1,150.00
1420-01	1,100.00	1,030.00	970.00	930.00

COMMUNICATIONS AND SIGNAL PROTECTORS BALANCED LINE PAIR

	1-24 Pieces	25-49 Pieces	50-99 Pieces	100-499 Pieces
1602-01	\$ 200.00 each	\$ 190.00	\$ 180.00	\$ 170.00
1603-01	200.00	190.00	180.00	170.00
1615-01	200.00	190.00	180.00	170.00
1615-02	200.00	190.00	180.00	170.00
1615-03	200.00	190.00	180.00	170.00
1617-02	225.00	210.00	200.00	190.00
1622-01	45.00	42.00	39.00	36.00
1623-01	120.00	110.00	105.00	100.00
1624-01	120.00	110.00	105.00	100.00
1625-01	120.00	110.00	105.00	100.00
1626-01	120.00	110.00	105.00	100.00
1633-01	50.00	44.00	38.00	34.00
1634-01	50.00	44.00	38.00	34.00

cont.

Model Number

COMMUNICATIONS AND SIGNAL PROTECTORS

BALANCED LINE PAIR

	1-24 Pieces	25-49 Pieces	50-99 Pieces	100-499 Pieces
1635-01	50.00	44.00	38.00	34.00
1636-01	50.00	44.00	38.00	34.00
1637-01	50.00	44.00	38.00	34.00
1640-01	50.00	42.00	35.00	28.00

**ANTENNA ARRESTERS
RECEIVING ONLY**

	1-24 Pieces	25-49 Pieces	50-99 Pieces	100-499 Pieces
1705-01	\$ 120.00 each	\$ 100.00	\$ 85.00	\$ 72.00
1705-02	120.00	100.00	85.00	72.00
1705-03	120.00	100.00	85.00	72.00
1705-04	120.00	100.00	85.00	72.00
1705-05	120.00	100.00	85.00	72.00
1705-06	120.00	100.00	85.00	72.00
1705-07	120.00	100.00	85.00	72.00
1705-08	120.00	100.00	85.00	72.00
1705-09	120.00	100.00	85.00	72.00

ANTENNA LIGHTNING ARRESTERS

	1-9 Pieces	10-49 Pieces	50-99 Pieces	100-299 Pieces
AD969-AJB (1901-02)	\$ 525.00 each	\$ 480.00	\$ 440.00	\$ 410.00
AD969-AJB-A (1901-03)	435.00	400.00	375.00	350.00
AD969-CG (1903-01)	95.00	95.00	85.00	75.00
1903-02	95.00	95.00	85.00	75.00
1903-04	95.00	95.00	85.00	75.00
1903-05	95.00	95.00	85.00	75.00
1903-11	95.00	95.00	85.00	75.00
AD969-DGA (1905-01)	300.00	285.00	270.00	255.00
AD969-DL (1906-01)	375.00	375.00	350.00	330.00
AD969-DMA (1908-01)	250.00	237.50	225.00	212.50
AD969-DMAC (1908-04)	290.00	275.00	260.00	245.00
(1908-05)	290.00	275.00	260.00	245.00
AD969-DTA (1910-01)	275.00	262.50	250.00	237.50
AD969-DW (1912-01)	350.00	350.00	335.00	325.00
AD969-ER (1913-01)	525.00	500.00	475.00	400.00
AD969-ERC (1914-01)	1,050.00	975.00	925.00	875.00
AD969-ETA (1916-01)	275.00	262.50	250.00	237.50
AD969-LAB (1917-01)	490.00	490.00	350.00	250.00
AD969-LAH (1918-01)	250.00	225.00	225.00	200.00
AD969-TB (1919-01)	1,425.00	1,425.00	1,425.00	1,425.00
1919-02	1,200.00	1,200.00	1,200.00	1,200.00
1919-03	1,200.00	1,200.00	1,200.00	1,200.00
1919-04	2,000.00	1,900.00	1,750.00	1,500.00
AD969-TC (1920-01)	2,000.00	1,850.00	1,750.00	1,690.00
1920-02	2,000.00	1,850.00	1,750.00	1,690.00
1920-03	2,000.00	1,850.00	1,750.00	1,690.00
AD969-TG (1921-01)	1,400.00	1,400.00	1,400.00	1,400.00
1921-02	1,600.00	1,600.00	1,600.00	1,600.00
AD969-TR (1922-01)	2,150.00	2,150.00	2,150.00	2,150.00
AD969-TRS (1922-03)	2,150.00	2,150.00	2,150.00	2,150.00
AD1000-BC (1927-01)	400.00	400.00	375.00	350.00
AD1000-FG (1928-01)	250.00	250.00	237.50	225.00
AD1000-FGA (1928-02)	275.00	275.00	262.50	250.00
AD1000-FGS (1930-01)	230.00	230.00	230.00	200.00
AD1211 (1931-01)	700.00	700.00	675.00	650.00
AD1211-A (1931-02)	700.00	700.00	675.00	650.00

LORAN COUPLERS

	1-9 Pieces	10-49 Pieces	50-99 Pieces	100-299 Pieces
AD969-LCB (2101-01)	\$ 110.00 each	\$ 110.00	\$ 105.00	\$ 100.00
AD969-LCH (2102-01)	110.00	110.00	105.00	100.00

Model Number

ANTENNA CONNECTORS

		1-9 Pieces	10-49 Pieces	50-99 Pieces	100-299 Pieces
AD1210	(1922-99)	\$ 50.00 each	\$ 50.00	\$ 50.00	\$ 50.00
AD1453	(1919-99)	50.00	50.00	50.00	50.00

PRECISION SPARK GAPS

	1-24 Pieces	25-49 Pieces	50-99 Pieces	100-499 Pieces
2001-01	\$ 1.45 each	\$ 1.25	\$ 1.25	\$ 1.00
2001-02	1.45	1.25	1.25	1.00
2001-03	1.45	1.25	1.25	1.00
2001-04	1.45	1.25	1.25	1.00
2001-05	1.45	1.25	1.25	1.00
2001-06	1.60	1.40	1.40	1.15
2001-07	1.60	1.40	1.40	1.15
2001-08	1.60	1.40	1.40	1.15
2001-09	1.60	1.40	1.40	1.15
2001-10	1.60	1.40	1.40	1.15
2001-11	26.00	23.00	23.00	21.00
2001-12	26.00	23.00	23.00	21.00
2001-13	26.00	23.00	23.00	21.00
2001-14	26.00	23.00	23.00	21.00
2001-20	26.00	23.00	23.00	21.00
2001-27	60.00	55.00	50.00	42.00
2001-28	60.00	55.00	50.00	42.00
2001-29	60.00	55.00	50.00	42.00
2001-30	60.00	55.00	50.00	42.00
2001-31	35.00	30.00	30.00	25.00
2001-32	35.00	30.00	30.00	25.00
2001-33	35.00	30.00	30.00	25.00
2001-34	35.00	30.00	30.00	25.00
2001-36	35.00	30.00	30.00	25.00
2001-37	18.00	15.00	15.00	13.00
2001-40	4.35	3.75	3.75	3.00
2001-46	4.35	4.00	4.00	3.65
2001-47	4.35	4.00	4.00	3.65
2001-48	4.35	4.00	4.00	3.65
2001-50	18.00	15.00	15.00	13.00
2001-51	18.00	15.00	15.00	13.00
2001-52	18.00	15.00	15.00	13.00
2001-53	18.00	15.00	15.00	13.00
2001-54	18.00	15.00	15.00	13.00
2001-61	8.50	7.50	7.50	6.75
2001-67	60.00	55.00	50.00	42.00
2001-82	17.00	15.25	15.25	13.75
2001-83	8.00	7.00	7.00	6.35
2001-89	4.75	4.40	4.40	4.00
2001-90	4.75	4.40	4.40	4.00
2001-93	4.75	4.40	4.40	4.00
2001-94	4.80	4.20	4.20	3.45
2002-01	50.00	44.00	39.00	36.00
2002-02	50.00	44.00	39.00	36.00
2002-03	50.00	44.00	39.00	36.00
2002-04	50.00	44.00	39.00	36.00
2002-05	50.00	44.00	39.00	36.00
2002-06	50.00	44.00	39.00	36.00
2003-01	95.00	80.00	70.00	65.00
2003-02	95.00	80.00	70.00	65.00
2008-02	68.00	50.00	50.00	47.00
2008-03	80.00	65.00	65.00	60.00
2009-03	70.00	60.00	60.00	50.00
2009-05	70.00	60.00	60.00	50.00
2009-09	40.00	35.00	35.00	30.00
2010-02	30.00	26.00	26.00	23.00
2011-01	70.00	60.00	60.00	50.00
2011-02	70.00	60.00	60.00	50.00

Model Number

COMMUNICATIONS AND SIGNAL PROTECTORS

	1-24 Pieces	25-49 Pieces	50-99 Pieces	100-499 Pieces	500-999 Pieces
2301-01	\$ 8.00 each	\$ 7.50	\$ 7.25	\$ 7.00	\$ 6.75
2301-05	65.00	56.00	48.00	39.00	33.00

USE OF JESD LABORATORY FACILITIES

1. General surge testing including use of second and third component equipment only (per MIL-A-9094C), including two technicians; including set-up time; (minimum billing period one day) . . . at \$ 500.00 per day
2. General surge testing involving first, second, and third components (per MIL-A-9094C), including two technicians and one engineer; including set-up time; (minimum billing period one day) .. at 1,000.00 per day
3. Use of leak detection equipment, including one operator technician; including set-up time; (minimum billing period one day) at 200.00 per day
4. We require a written test plan of what the customer proposes to do. We will provide a firm price quotation based on that test plan. If during the actual testing there is a significant deviation from the test plan involving the use of more equipment or extended time periods, actual billing will reflect the original quotation plus the tests or testing time which exceeded the original test plan.
5. The above quoted prices include test reports. The exact reporting requirements are to be spelled out in the test plan. If there will be any unusual expense for oscillographic records; color or black and white photographs; other unusual and relatively expensive test reporting, actual billing will reflect the unusual expenses.

TERMS OF SALE

1. F.O.B. shipping point, Goleta, California.
2. Terms: Net 30 days.
3. Export or preservation packing is extra. Price on application.
4. MIL-SPEC requirements as applicable require special quotation.
5. Qualification testing as required will be quoted as a separate item.
6. Delivery: Usually 30-90 days after receipt of order.
Specific delivery quotation will be made on request.
7. Minimum Order \$15.00.
8. Prices are subject to change without notice.



JOSLYN ELECTRONIC SYSTEMS

Division of Joslyn Mfg. and Supply Co.

6868 Cortona Drive, Santa Barbara Research Park
P. O. Box 817, Goleta, California 93017
Telephone: 805-968-3551

Systems Protection in a Nuclear and Space Age Environment



JOSLYN

ELECTRONIC SYSTEMS

1200 SERIES

AC PROTECTORS

1 PHASE, 60 Cy.

250 VOLTS RMS MAX.

LIGHTNING AND ELECTRICAL SURGE PROTECTOR

GROUNDING SYSTEMS ONLY

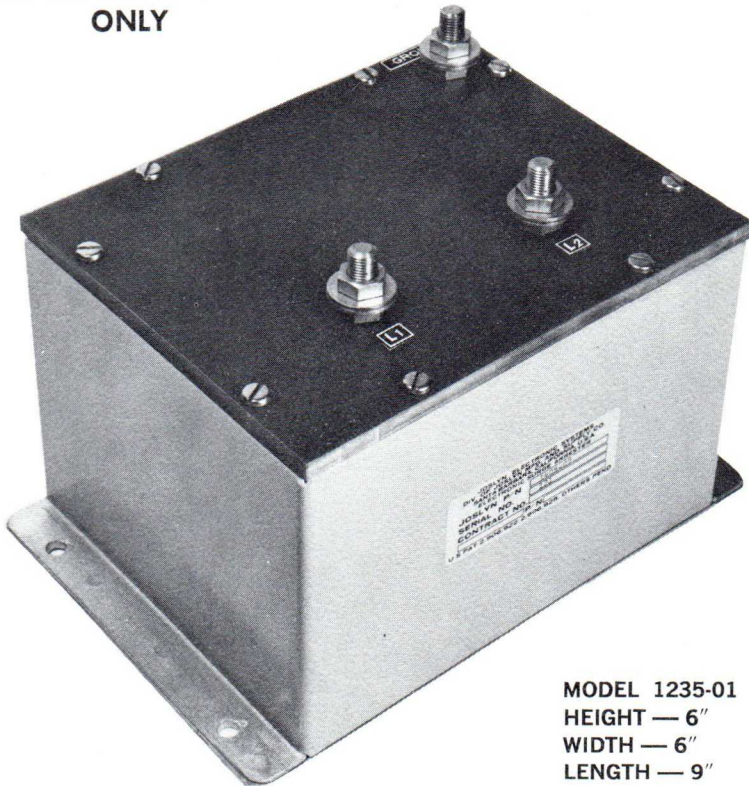

MODEL 1235-01
HEIGHT — 6"
WIDTH — 6"
LENGTH — 9"

Photo illustrates the two element device 120/240 v. mid point ground.

DESCRIPTION

The Joslyn lightning and electrical surge protectors, model 1200 series, are designed for use on power systems of any kva rating, 1 phase, 120 and 120/240 volts 60 cycles. The purpose of these protectors is to limit surge voltages and prevent damage to electrical and electronic equipment by discharging or bypassing the harmful transients.

The protectors also prevent the continued flow of follow current by the use of special techniques. The follow current is extinguished on the first current zero point of the 60-cycle wave. The protector also offers very low clamping levels and an unusually long service life.

EXCLUSIVE FEATURES

ULTRAFAST PRECISION RESPONSE:
Less than 0.4 microsecond time required to clamp a transient voltage with a ramp of 10 kv per microsecond to a safe value of less than 175 volts.

PROVIDES MAXIMUM EQUIPMENT PROTECTION:
Precision response and high surge current carrying capacity guarantee maximum protection for all sensitive electronic circuits, particularly those employing solid-state components (diodes, transistors, SCR's, etc.).

SLOW-RISING WAVE RESPONSE:
Maximum reliability in the sensing and clamping of switching transients or overvoltage surges. On slow-rising waves the voltage clamping begins at 175v rms.

DIRECT STROKE LIGHTNING CAPACITY:
The protector will take direct strokes in excess of 65,000 amperes (10 x 20 microsecond waveshape) followed by a 75 ampere square wave surge of 1000 microseconds duration.

**EXCLUSIVE
FEATURES**
(Continued)

LINE INSERTION LOSS:
No loss or power consumption as the device is passive and contains no moving parts.

**OPERATIONAL LIFE
EXPECTANCY:**

A minimum of 2,000 operations. A single operation is defined as a 10,000 ampere discharge current with a 10 x 20 microsecond waveshape plus the resulting system power-follower.

MAINTENANCE:

No inspection or maintenance is required.

**VENT-FREE
CONSTRUCTION:**

The protector discharge device is hermetically sealed. All gases and other arcing phenomena are contained within the sealed enclosure.

SPECIAL ENCLOSURES

Special enclosures are available. Prices on request.

OTHER AC MODELS

See descriptive bulletins on the 1200 Series Single Phase and 1400 Series Three Phase Protectors.

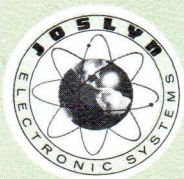

APPLICATIONS

The 1200 Series, models 1230-01 and 1235-01 will protect the following types of circuits and equipment against surge conditions.

- AC-powered equipment in microwave installations, telemetry stations, supervisory control networks.
- Solid-state electronic equipment using semiconductors.
- Critical power control circuits at military installations involving missile firing and guidance control.
- AC-power instrumentation and numerical control circuits.
- Low-insulation level electrical and electronic equipment, including vulnerable fine-wire relay coils.
- Computers.
- Standby power systems, inverters, and static relays.

CONNECTION DESCRIPTION

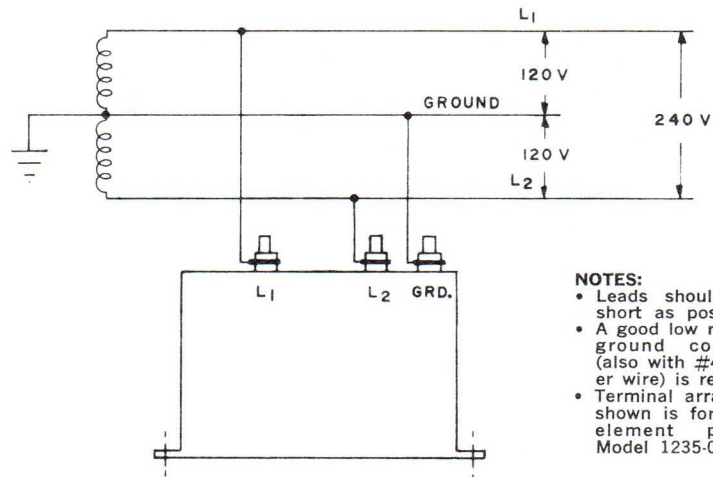

OUTLINE DIMENSIONS

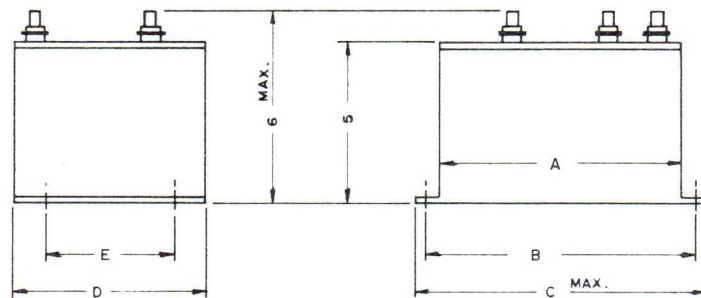

VARIABLE DIMENSIONS AND WEIGHTS

MODEL	A	B	C	D	E	WEIGHT
1230-01 1 ELEMENT	4"	4 ⁷ / ₈ "	5 ¹ / ₂ "	6"	4"	7 LBS. MAX.
1235-01 2 ELEMENT	7 ¹ / ₂ "	8 ³ / ₈ "	9"	4"	2 ¹ / ₂ "	10 LBS. MAX.

POSSIBLE SOURCES OF DAMAGING SURGES OR TRANSIENTS

1. Voltage spikes from lightning strokes, both direct hits and induced effects. The model 1200 Series is able to handle repeated transients from lightning strokes.
2. Inductive or capacitive switching will produce damaging transients. For example, the switching to standby generators, the starting of large industrial or air-conditioning motors, or the resumption of service after a main power outage or "blackout" will cause damaging surges.
3. Miscellaneous sources of transients could also be found in industrial locations where arc welding is used as well as fluorescent-type lighting, etc.

TECHNICAL SPECIFICATIONS

SPECIFICATION CATEGORY	MODEL 1230-01	MODEL 1235-01
Nominal operating voltage (rms)	120v	120/240v
System circuit	Two wires: 1 wire energized 1 wire ground	Three wires midpoint ground: 2 wires energized 1 wire ground
AC sparkover voltage (rms)	175v rms line-to-ground	175v rms line-to-ground
Impulse sparkover voltage (peak) (Note #1)	<2 kv maximum Line-to-ground	<2 kv maximum Line-to-ground
Discharge voltage (peak) (Note #2)	<2 kv maximum Line-to-ground	<2 kv maximum Line-to-ground
Rated number of operations (Note #3)	2,000 operations minimum	2,000 operations minimum
Number of elements per protector (Note #4)	One element total	Two elements total

- Note #1 The impulse sparkover voltage breakdown is taken from front of wave with a rate-of-rise of 10 kv per microsecond of either polarity.
- Note #2 The discharge voltage is determined from a flow of 10,000 ampere crests on a 10 x 20 microsecond waveshape.
- Note #3 A single operation consists of a 10,000 ampere discharge current (10 x 20 microsecond waveshape) and the resulting power follow-current which automatically extinguishes at first current zero.
- Note #4 Each element consists of two passive components as follows:
1. A follow-current limiting resistive element mounted in a rigid holder.
 2. A hermetically sealed high-power precision discharge device. No semiconductor or silicon carbide materials are used.

MODE OF OPERATION: Automatic and self-restoring. The unit is on duty at all times. There is no loss of duty during the one-half cycle restoring period and it will effectively operate on any surge occurrence with either slow or very fast rate-of-rise conditions.

EXTREME DUTY DISCHARGE CAPACITY: 65,000 amperes (10 x 20 microsecond waveshape) followed by a 75 ampere square wave surge of 1,000 microseconds duration.

EXTENDED TEMPERATURE RANGE: The unit will operate with full efficiency throughout a temperature range of -40°F to 160°F.

ALTITUDE RANGE: Maximum operational altitude of 12,000 feet.

ZERO INSERTION LOSS: The protector is a passive device. No energy-consuming components are used.

ENCLOSURE DETAILS: A sheet metal enclosure is provided with an insulated terminal board. Special enclosures are available.

KVA RATING LIMITATION: This device is not limited to low kva rated distribution systems. However, in the case of unusually high-rated systems, 100 kva and up, we recommend consideration be given to our model 1240 Series for heavy-duty applications.

OSCILLOGRAMS OF PROTECTOR RESPONSE

Fig. 1 IMPULSE VOLTAGE

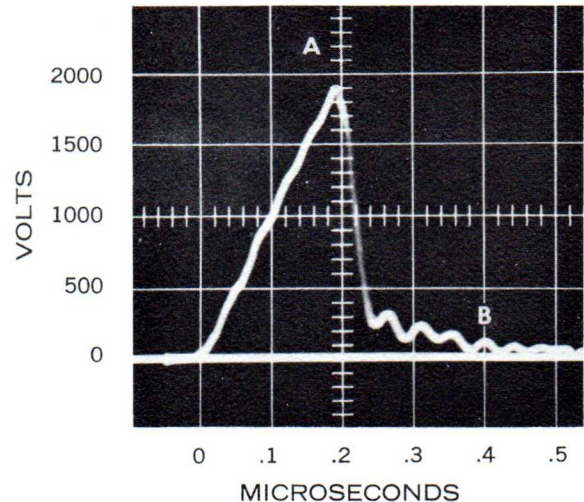

THE IMPULSE VOLTAGE oscillogram (unretouched) illustrates the fast response of the protector. For example, an impulse voltage applied at a 10,000 volt per microsecond rate of rise will result in the breakdown voltage shown at point "A." This voltage clamping at less than 2000 volts occurs in less than 0.2 microseconds. The voltage spike is further reduced to less than 175 volts as shown at point "B" within 0.4 microseconds.

Fig. 2 DISCHARGE VOLTAGE

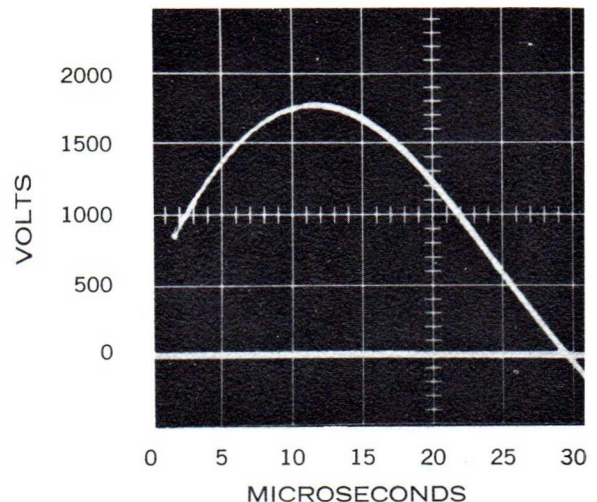

THE DISCHARGE VOLTAGE oscillogram (unretouched) illustrates the effective clamping action of the protector. Less than 2000 volts appears across the protector terminals when a discharge current of 10,000 amps, with a wave shape of 10 x 20 microseconds, flows through the protector.

DEFINITIONS

LIGHTNING AND ELECTRICAL SURGE PROTECTOR

A protective device for limiting surge voltages on equipment by discharging or bypassing surge current. It prevents continued flow of follow current to ground and is capable of repeating these functions.

SURGE

A surge in an electrical circuit is a transient wave of current, potential, or power.

WAVESHAPES DESIGNATION OF A SURGE

The waveshape of a surge of current or voltage is designated by a combination of two numbers. The first number is an index of the wavefront expressed in microseconds from zero to the peak of the wave. The second number is an index of the wavetail also expressed in microseconds from zero to the instant that the wavetail reaches one-half of the crest or peak value. Example: 10 x 20 microsecond wave.

POWER FREQUENCY SPARKOVER VOLTAGE

The power-frequency sparkover voltage of a protector (arrester) is the rms value of the lowest power-frequency sine-wave voltage that will cause sparkover when applied across its terminals.

IMPULSE SPARKOVER VOLTAGE

The impulse sparkover voltage of a protector (arrester) is the highest value of voltage attained by an impulse of a designated waveshape and polarity applied across its terminals prior to the flow of discharge current.

DISCHARGE CURRENT

The discharge current of a protector (arrester) is the surge current which flows through the protector when sparkover occurs.

DISCHARGE VOLTAGE

The discharge voltage of a protector (arrester) is the voltage that appears across its terminals during passage of discharge current.

FOLLOW (POWER) CURRENT

The follow current of a protector (arrester) is the current from the connected power source which flows through the protector during and following the passage of discharge current.

INFORMATION REQUIRED FOR SPECIAL APPLICATIONS

- 1. SOURCE OF TRANSIENT OR SURGE:**
Lightning strikes, switching surges, over-voltages, etc.
- 2. DESCRIPTION OF THE TRANSIENT**
Peak voltage or current?
Single or repetitive pulses?
Interval between peaks?
- 3. TRANSIENT WAVEFORM INFORMATION**
Are oscillograms available for our analysis?
- 4. DESCRIPTION OF THE EQUIPMENT TO BE PROTECTED**
Advise the maximum voltage tolerance of the equipment
What is the environment of the installation?
- 5. DESCRIPTION OF THE NORMAL LINE POWER SOURCE**
Single or three phase?
Grounded or ungrounded systems?
Voltage, frequency, and KVA rating of the load?
Short circuit current available?
Circuit impedance to limit fault current?
- 6. MISCELLANEOUS APPLICABLE SPECIFICATIONS**
Vibration, shock, humidity, temperature, etc.

HOW TO ORDER

Specify the full model number of the protector and, as a double-check, give the full details of use. We also recommend a review of the adjacent list of questions for SPECIAL APPLICATIONS.

JOSLYN QUALITY CONTROL POLICY

Quality control procedures in force at Joslyn Electronic Systems meet the rigorous requirements of MIL-Q-9858A and Boeing D1-8000A.

JOSLYN

ELECTRONIC SYSTEMS

SANTA BARBARA RESEARCH PARK
P. O. BOX 817
GOLETA, CALIFORNIA 93017
TELEPHONE: 805 968-3551



JOSLYN

ELECTRONIC SYSTEMS

1200 SERIES
EXTRA PROTECTION
A C PROTECTORS
1 PHASE, 60 Cy.
250 VOLTS RMS MAX.

LIGHTNING AND ELECTRICAL SURGE PROTECTOR

GROUNDING SYSTEMS
ONLY

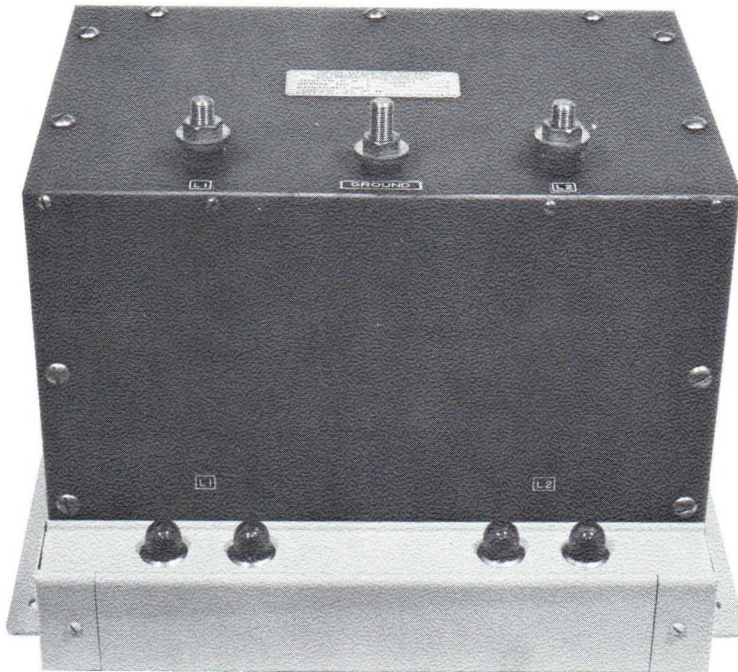

MODEL 1245-01 HEIGHT — 10" WIDTH — 8" LENGTH — 11¼"
THREE WIRE CENTER TAP GROUND

DESCRIPTION

The Joslyn "extra protection" model 1245-01 surge protector is designed for application on 120/240v single-phase center tap, 60-cycle power systems of any kva rating. It is particularly recommended for applications where transients must be limited to values of 1,000v peak or less.

Model 1245-01 is equipped with a special triggering circuit and pilot light which monitors condition at all times.

Joslyn's proven engineering design techniques offer the user unusually long service life (more than 3,000 operations); and precision interruption of 60-cycle power-follow current at first current zero. Users of Joslyn protectors are reporting long trouble-free, maintenance-free service life.

Joslyn has a growing list of satisfied military and industrial clients throughout the aerospace, communications, and transportation industries.

EXCLUSIVE FEATURES

ULTRAFAST PRECISION RESPONSE:
Less than 0.1 microsecond time required to clamp a transient voltage with a ramp of 10 kv per microsecond to a safe value of less than 1000 volts.

PROVIDES MAXIMUM EQUIPMENT PROTECTION:
Precision response and high surge current capacity guarantee maximum protection for all sensitive electronic circuits, particularly those employing solid-state components (diodes, transistors, SCR's, etc.).

SLOW-RISING WAVE RESPONSE:
Maximum reliability in the sensing and clamping of switching transients or overvoltage surges. On slow-rising waves the voltage clamping begins at approximately 300% of the rms line-to-ground voltage.

LINE INSERTION LOSS:
The device is passive and contains no moving parts. Power consumption is negligible. Neon pilot lamps consume less than 2 watts.

**EXCLUSIVE
FEATURES**
(Continued)

**OPERATIONAL
LIFE EXPECTANCY:**

A minimum of 3,000 operations, at a magnitude of 10,000 amperes (10 x 20 microsecond waveshape) surge current discharge and resulting power follow current per phase.

MAINTENANCE

No routine inspection or maintenance is required.

**VENT-FREE
CONSTRUCTION:**

The discharge device is hermetically sealed. All gases and other arcing phenomena are contained within the device.

OPTIONAL FEATURES:

**SPECIAL CLAMPING
VOLTAGE:**

On special application, voltage ramps of slower rates-of-rise can be clamped at approximately 250 volts peak.

**SPECIAL
ENCLOSURES:**

Special enclosures per user's requirements are available. Prices on request.

OTHER AC MODELS

See descriptive bulletins on the 1200 Series Single Phase and 1400 Series Three Phase Protectors.



APPLICATIONS

The 1200 Series, model 1245-01 will protect the following types of circuits and equipment against surge conditions.

- Solid-state electronic equipment using semi-conductors.
- AC-powered instrumentation.
- AC input power supplies to microwave stations as well as other telephone, railroad, pipeline, or communication base stations.
- Low insulation level electrical and electronic equipment, including vulnerable fine-wire relay coils.
- Critical power control circuits at military installations involving missile firing and guidance control.

CONNECTION DIAGRAM

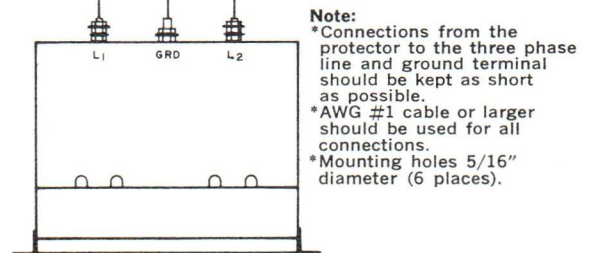
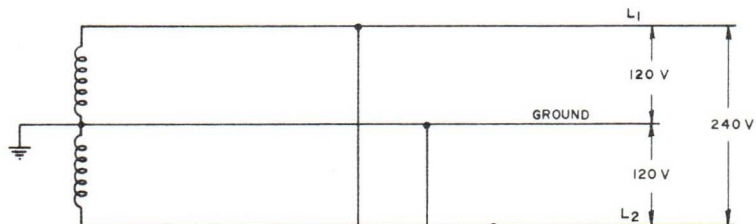

Note:
*Connections from the protector to the three phase line and ground terminal should be kept as short as possible.
*AWG #1 cable or larger should be used for all connections.
*Mounting holes 5/16" diameter (6 places).

OUTLINE DIMENSIONS

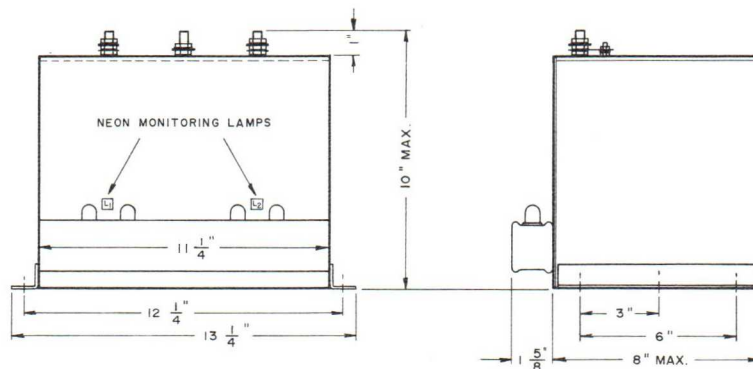

WEIGHT: 33 lbs. max.

OSCILLOGRAMS OF PROTECTOR RESPONSE

Fig. 1 IMPULSE VOLTAGE

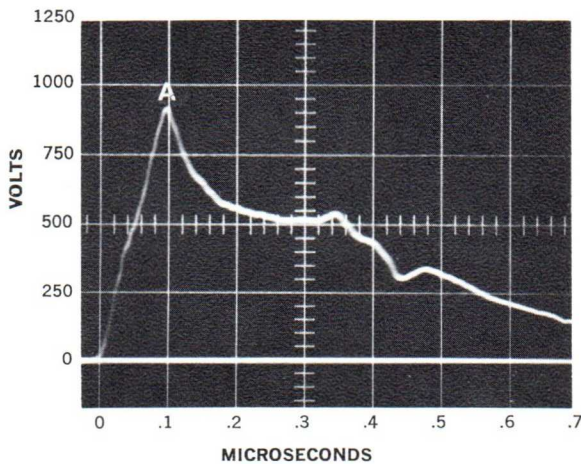

IMPULSE VOLTAGE oscillogram illustrates the voltage breakdown on front of wave of 10,000 volts per microsecond rate of rise. The breakdown occurs at less than 1000 volts (point A) in less than 0.10 microseconds. The voltage is further clamped to less than 400 volts in less than 0.5 microseconds.

Fig. 2 DISCHARGE VOLTAGE

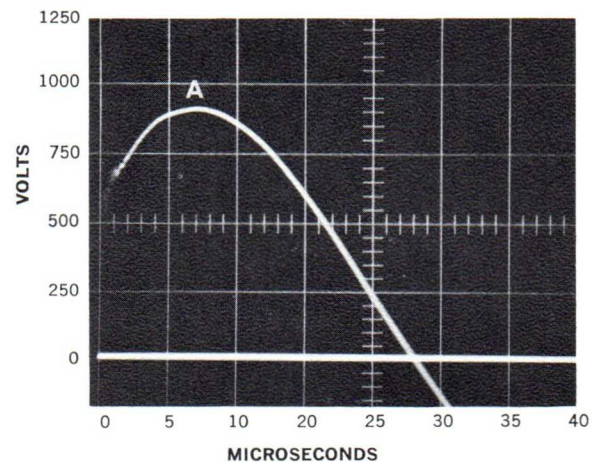

DISCHARGE VOLTAGE oscillogram demonstrates the maximum value of voltage across the protector terminals of less than 1000 volts (point A) with 10,000 ampere (10 x 20 microsecond waveshape) discharge current flowing through the protector.

TECHNICAL SPECIFICATIONS

- AC SPARKOVER VOLTAGE:** 360 volts rms \pm 15%, line-to-ground.
On surges with slow rates-of-rise clamping begins at approximately 500 volts peak.
- IMPULSE SPARKOVER VOLTAGE:** Less than 1.0 kv in less than 0.1 microsecond.
On a rate-of-rise surge of 10 kv per microsecond of either polarity.
- DISCHARGE VOLTAGE:** Less than 1.0 kv with an applied discharge current of 10,000 amperes on a 10 x 20 microsecond waveshape.
- RATED NUMBER OF OPERATIONS:** Minimum of 3,000 per phase
A single operation consists of a 10,000 ampere discharge current (10 x 20 microsecond waveshape) and the resulting power-follow current which automatically extinguishes at first current zero (within one half-cycle).
- EXTREME DUTY DISCHARGE CAPACITY:** 100,000 amperes (10 x 20 microsecond waveshape) followed by a 150 ampere square wave surge of 2,000 microseconds duration.
- MODE OF OPERATION:** Automatic and self-restoring
The unit is on duty at all times. There is no loss of duty during the one-half cycle restoring period and it will effectively operate on any surge occurrence of either slow or very fast rate-of-rise.
- NEGLIGIBLE INSERTION LOSS:**
The protector is a passive device. Neon pilot lamps consume less than 2 watts.
- EXTENDED TEMPERATURE RANGE:**
The unit will operate with full efficiency throughout a temperature range of -40°F to 160°F .
- ALTITUDE RANGE:** Maximum operational altitude of 12,000 feet.
- ENCLOSURE DETAILS:**
Sheet metal enclosure with insulating terminal board. Special enclosures are available.

DEFINITIONS

LIGHTNING AND ELECTRICAL SURGE PROTECTOR

A protective device for limiting surge voltages on equipment by discharging or bypassing surge current. It prevents continued flow of follow current to ground and is capable of repeating these functions.

SURGE

A surge in an electrical circuit is a transient wave of current, potential, or power.

WAVESHAPES DESIGNATION OF A SURGE

The waveshape of a surge of current or voltage is designated by a combination of two numbers. The first number is an index of the wavefront expressed in microseconds from zero to the peak of the wave. The second number is an index of the wavetail also expressed in microseconds from zero to the instant that the wavetail reaches one-half of the crest or peak value. Example: 10 x 20 microsecond wave.

POWER FREQUENCY SPARKOVER VOLTAGE

The power-frequency sparkover voltage of a protector (arrester) is the rms value of the lowest power-frequency sine-wave voltage that will cause sparkover when applied across its terminals.

IMPULSE SPARKOVER VOLTAGE

The impulse sparkover voltage of a protector (arrester) is the highest value of voltage attained by an impulse of a designated waveshape and polarity applied across its terminals prior to the flow of discharge current.

DISCHARGE CURRENT

The discharge current of a protector (arrester) is the surge current which flows through the protector when sparkover occurs.

DISCHARGE VOLTAGE

The discharge voltage of a protector (arrester) is the voltage that appears across its terminals during passage of discharge current.

FOLLOW (POWER) CURRENT

The follow current of a protector (arrester) is the current from the connected power source which flows through the protector during and following the passage of discharge current.

INFORMATION REQUIRED FOR SPECIAL APPLICATIONS

- 1. SOURCE OF TRANSIENT OR SURGE:**
Lightning strikes, switching surges, over-voltages, etc.
- 2. DESCRIPTION OF THE TRANSIENT**
Peak voltage or current?
Single or repetitive pulses?
Interval between peaks?
- 3. TRANSIENT WAVEFORM INFORMATION**
Are oscillograms available for our analysis?
- 4. DESCRIPTION OF THE EQUIPMENT TO BE PROTECTED**
Advise the maximum voltage tolerance of the equipment
What is the environment of the installation?
- 5. DESCRIPTION OF THE NORMAL LINE POWER SOURCE**
Single or three phase?
Grounded or ungrounded systems?
Voltage, frequency, and KVA rating of the load?
Short circuit current available?
Circuit impedance to limit fault current?
- 6. MISCELLANEOUS APPLICABLE SPECIFICATIONS**
Vibration, shock, humidity, temperature, etc.

HOW TO ORDER

Specify the full model number of the protector and, as a double-check, give the full details of use. We also recommend a review of the adjacent list of questions for SPECIAL APPLICATIONS.

JOSLYN QUALITY CONTROL POLICY

Quality control procedures in force at Joslyn Electronic Systems meet the rigorous requirements of MIL-Q-9858A and Boeing D1-8000A.

*ALL DATA SUBJECT TO CHANGE
WITHOUT NOTICE*

JOSLYN

ELECTRONIC SYSTEMS

SANTA BARBARA RESEARCH PARK
P. O. BOX 817
GOLETA, CALIFORNIA 93017
TELEPHONE: 805 968-3551

JOSLYN

'FULL-LINE' SURGE PROTECTION YOUR COMPLETE SOURCE OF TOP PERFORMANCE PROTECTORS . . . FOR PROTECTING ELECTRICAL/ELECTRONIC EQUIPMENT FROM: VOLTAGE TRANSIENTS · CURRENT TRANSIENTS · DIRECT LIGHTNING STRIKES · OVER-ILLUMINATION

PRECISION SPARK GAPS

Typical applications: used to protect against surges due to switching, breakers closing-opening, static, reflected waves, capacitive discharge, corona, system faults, contact with foreign circuits, EMP, fuse blowing, lightning (induced or conducted), ionization, motor starting, arc welding.

They protect solid state circuitry, computers, carrier circuits, relay coils, telephone circuits, microwave and radio equipment, sensitive equipment, open wire carriers, fire alarms, traffic controllers, rectifiers, modulators, traveling wave tubes, pyrotechnic devices.

They replace carbon block arresters, light sensitive gaps, open air gaps, high maintenance protection devices, fragile gaps, mechanically incompatible gaps, radioactivated gaps.

They may be used as activation devices in pyrotechnic devices, lamp starting circuits, laser pulsers.

msp® (miniature surge protector)

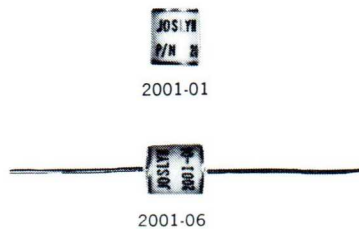

MSP® Model No.	Nominal DC Sparkover Voltage ±15%	Impulse Sparkover Voltage* at 10 kv/μs rate-of-rise	Impulse Sparkover Voltage* at 500 v/μs rate-of-rise	Minimum Holdover Voltage	Wire Leads	SIZE dia. x length
2001-01	230	730	540	115	none	5/16" x 11/32"
2001-02	350	870	670	175	none	5/16" x 11/32"
2001-03	470	1030	810	235	none	5/16" x 11/32"
2001-04	800	1390	1140	400	none	5/16" x 11/32"
2001-06	230	730	540	115	yes	5/16" x 11/32"
2001-07	350	870	670	175	yes	5/16" x 11/32"
2001-08	470	1030	810	235	yes	5/16" x 11/32"
2001-09	800	1390	1140	400	yes	5/16" x 11/32"

*Taken from volt-time curves below.

Note: Other ratings, terminal mountings, and configurations made to order. Consult factory.

response curves for msp® gaps

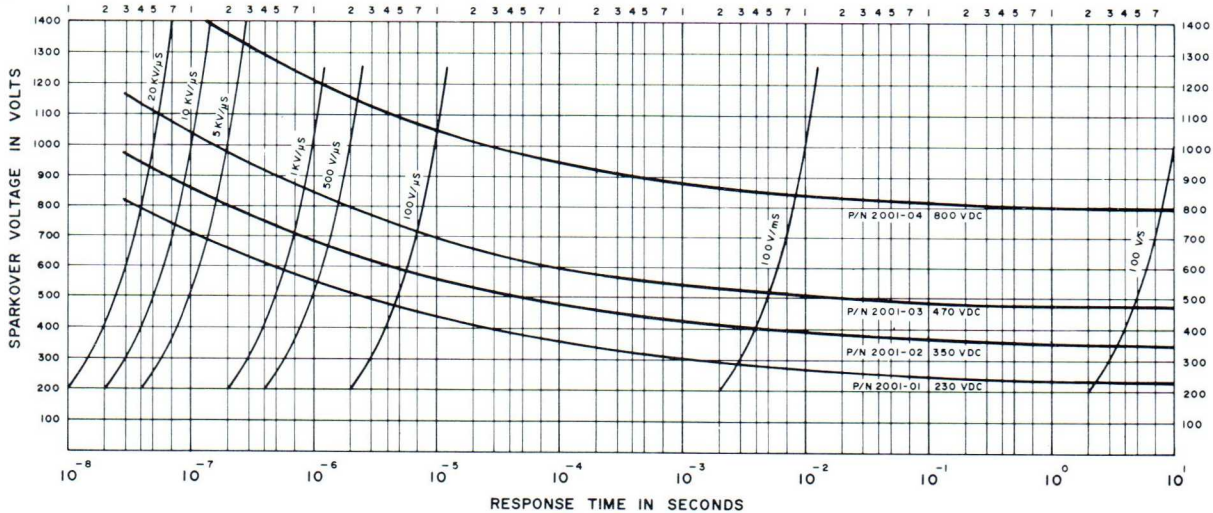

® Registered U.S. Patent Office, Joslyn Electronic Systems.



Standard Model No.	Max. Surge Current ka 10 x 20 / μs	DC Breakdown Volts ±15%	Impulse Sparkover Typical 10 kv/μs	Inter-Electrode Capacitance pf	Insulation Resistance m Ω	Max. space envelope dia. — h.
2001-28	1	> 750	< 2000*	< 2	> 10,000	1/2" x 1 3/16"
2001-29	1	> 1100	< 2000*	< 2	> 10,000	1/2" x 1 3/16"
2001-30	1	> 450	< 1200*	< 2	> 10,000	1/2" x 1 3/16"
2001-31	5	230	875	3.5 max.	> 1000	1/2" x 1/2"***
2001-32	5	350	1100	3.5 max.	> 1000	1/2" x 1/2"***
2001-33	5	470	1300	3.5 max.	> 1000	1/2" x 1/2"***
2001-34	5	800	1600	3.5 max.	> 1000	1/2" x 1/2"***
2001-35	5	1000	2000	3.5 max.	> 1000	1/2" x 1/2"***
2002-01	40	250	—	< 8	> 1000	7/8" x 2 1/2"
2002-06	40	2000	—	< 8	> 1000	7/8" x 2 1/2"
2003-01	40	L-L220 L-g400	—	L-L < 5 L-g < 8	> 1000	7/8" x 2 1/2"
2003-02	40	L-L230 L-g275	—	L-L < 5 L-g < 8	> 1000	7/8" x 2 1/2"
2008-02	20	250	—	< 4	> 1000	1 3/8" x 2 3/8"
2008-03	20	250	—	< 4	> 1000	1 3/8" x 2 3/8"

*50 kv/μs

**with 6-32 gnd. stud., 5/16/g.

Note: Other voltage ratings up to 3000 v DC, terminal mountings, and configurations made to order. Consult factory.

SURGITRON[®] PROTECTORS

surgitron[®] dc protectors

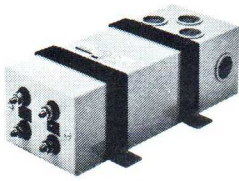

1001-01

surgitron[®] ac protectors single phase, 60 cycles



1201-02

surgitron[®] ac protectors three phase, 60 cycles

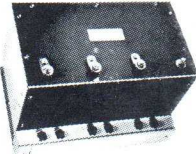

1414-06

communication protectors

balanced pair*
frequency range—dc to 1 mhz

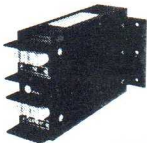

1603-01

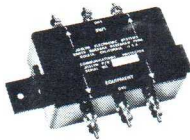

1623-01

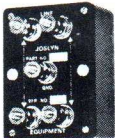

1633-01

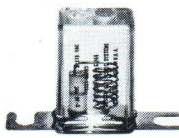

VISI-GUARD[®]
2301-01



1705-03

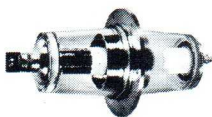

1908-01
(AD969-DMA)

TYPICAL APPLICATIONS: used to eliminate transients on battery circuits; protect critical equipment on railroads, at microwave sites and public utilities.

Joslyn Model Number	Nominal Input DC Volts*	System Polarity	Max. Load Current	Voltage Drop at 20 amp	Max. Surge Current	Clamping Voltage	Max. Size H-W-L
1001-03	28	Neg. Gnd.	20 amp	1.5V	5,000 amp	45-50	3 3/8" x 4 3/8" x 11 1/4"
1001-04	28	Pos. Gnd.	20 amp	1.5V	5,000 amp	45-50	3 3/8" x 4 3/8" x 11 1/4"
1003-03	48	Neg. Gnd.	20 amp	1.5V	5,000 amp	70-80	3 3/8" x 4 3/8" x 11 1/4"
1003-04	48	Pos. Gnd.	20 amp	1.5V	5,000 amp	70-80	3 3/8" x 4 3/8" x 11 1/4"
1005-05	72	Neg. Gnd.	20 amp	1.5V	5,000 amp	95-105	3 3/8" x 4 3/8" x 11 1/4"
1005-06	72	Pos. Gnd.	20 amp	1.5V	5,000 amp	95-105	3 3/8" x 4 3/8" x 11 1/4"
1010-01	12	Neg. Gnd.	20 amp	1.0V	5,000 amp	15-22	3 3/8" x 4 3/8" x 11 1/4"
1010-02	12	Pos. Gnd.	20 amp	1.0V	5,000 amp	15-22	3 3/8" x 4 3/8" x 11 1/4"

*Other voltages available — consult factory.

TYPICAL APPLICATIONS: used to protect critical equipment operating from commercial power such as at missile installations, industrial plants, microwave repeater sites.

Joslyn Model No.	Voltage Rating rms	Power Rating kva	Extreme Discharge Capacity ka	Clamping Begins at rms Volts ±15%	Transient into Protector		Max. Output Volts	Max. Space Envelope L-W-H
					Peak ka 1 1/2 x 40 μs Wave	Peak ka 10 x 20 μs		
1201-02	120	1	65	175	23	20	250	11 1/2" x 6" x 5 3/4"
1202-01	120	5	100	193	10	10	1750	10 3/4" x 8" x 7 3/4"
1230-01	120	not restricted	65	175	10	10	2000	5 1/2" x 4" x 6"
1235-01	120/240	not restricted	65	175 L-g	10	10	2000	9" x 6" x 6"
1245-01	120/240	not restricted	100	360 L-g	10	10	1000	13 1/4" x 9 5/8" x 10"

TYPICAL APPLICATIONS: same as for single-phase protectors. These units will limit voltage rise on a power distribution system counteracting effects of lightning and EMP.

1405-02	120/208	not restricted	65	175	10	10	2000	9" x 6" x 6"
1414-02	277/480	not restricted	100	372	10	10	—	14 1/4" x 8" x 10"
1414-06	277/480	not restricted	100	425	10	10	1000	14 1/4" x 9 5/8" x 10"
1420-01	120/208	not restricted	65	175	10	10	1000	14 1/4" x 9 5/8" x 10"

Note: Consult factory for full-line information.

TYPICAL APPLICATIONS: used along railroad right-of-ways, in process control instrumentation, in conjunction with telephone and telemetry applications.

Joslyn Model No.	Max. Signal Peak Volts	Insertion Loss at Max. Signal db	Discharge Rating ka 10x20 μs	Transient into Protector		Max. Output Volts	Max. Space Envelope L-W-H
				Peak kv	Peak ka 10x20 μs		
1601-01	0.224	<1	40	10	10	<100 @ 1 μs	7" x 2" x 5"
1602-01	0.388	<1	40	10	10	<100 @ 1 μs	7" x 2" x 5"
1603-01	0.775	<1	40	10	10	<100 @ 1 μs	7" x 2" x 5"
1623-01	1	<0.5	40	10	10	<120 @ 0.2 μs	8.8" x 6.4" x 2.2"
1624-01	2	<0.5	40	10	10	<120 @ 0.2 μs	8.8" x 6.4" x 2.2"
1625-01	10	<0.5	40	10	10	<120 @ 0.2 μs	8.8" x 6.4" x 2.2"
1626-01	50	<0.5	40	10	10	<120 @ 0.2 μs	8.8" x 6.4" x 2.2"
1633-01	1	<0.5	10	10	5	<120 @ 0.2 μs	4" x 2.9" x 3"
1634-01	2	<0.5	10	10	5	<120 @ 0.2 μs	4" x 2.9" x 3"
1635-01	10	<0.5	10	10	5	<120 @ 0.2 μs	4" x 2.9" x 3"
1636-01	50	<0.5	10	10	5	<120 @ 0.2 μs	4" x 2.9" x 3"
2301-01	—	0	5	10	—	<200 @ 0.25 μs	3" x 0.9" x 1.4"

*For single-ended units contact factory. Note: Consult factory for full-line information.

® Registered trademark of Joslyn Electronic Systems.

ANTENNA ARRESTERS

receive only

Used in conjunction with precision spark gaps on receivers, to attenuate voltage spikes to negligible levels. Available in many models and frequencies. Consult factory for full listing.

ANTENNA LIGHTNING ARRESTERS

receive and/or transmit

Used on commercial and military aircraft for direct lightning diversion. Qualified per Mil-A-9094 (as amended). Frequency range from 40 kc/s to 36 mc/s. Consult factory for full-line offering and complete device specifications.

LOOK TO JOSLYN FOR ALL YOUR SURGE PROTECTION NEEDS

6868 Cortona Drive, Santa Barbara Research Park
Goleta, Calif., Phone (805) 968-3551 • Reply to:
P.O. Box 817, Goleta, California 93017



JOSLYN

ELECTRONIC SYSTEMS

A DIVISION OF JOSLYN MFG. AND SUPPLY CO.

Reprinted from eem — Electronic Engineers Master — 1969-70 Edition

PRINTED
IN
U.S.A.



JOSLYN PRECISION SPARK GAPS

FEATURING THE 2001 MSP® SERIES

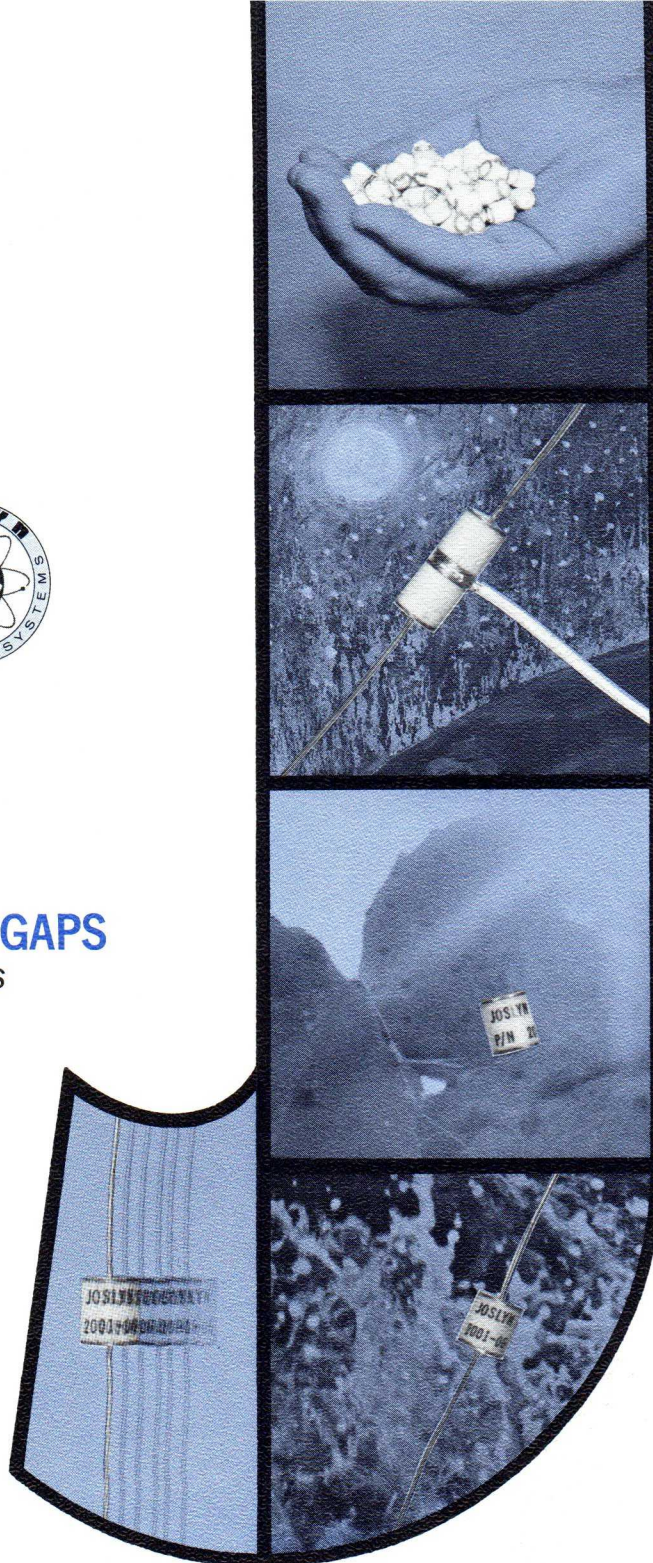

THE JOSLYN MSP® (Miniature Surge Protector) IS A PRECISION OPERATING SPARK GAP DESIGNED FOR RUGGED ELECTRICAL AND ENVIRONMENTAL DUTY. THE SPARK GAP IS CONSTRUCTED OF CERAMIC BODY AND HERMETICALLY SEALED ELECTRODES. IT IS GAS FILLED TO GIVE DC VOLTAGE BREAKDOWN IN 230 V, 350 V, 470 V, 800 V, AND OTHER RANGES.

THIS SEALED UNIT IS NOT INFLUENCED BY HUMIDITY, ALTITUDE, TEMPERATURE, SAND OR DUST, SALT SPRAY, INSULATING OILS, OR POTTING COMPOUNDS. THE UNIT WILL WITHSTAND HEAVY SHOCK AND VIBRATION, AND SEVERE THERMAL CYCLING. JOSLYN LOW-LEVEL CLAMPING MSP® SPARK GAPS POSSESS UNEQUALLED AND EXTREMELY FAST RESPONSE TO SURGES (SEE VOLT-TIME CURVES). THEY PERFORM WITH REPEATABILITY, AND WITH A HIGH LEVEL OF RELIABILITY AND LONG LIFE.



®Registered U.S. Patent Office
Joslyn Electronic Systems

EXCLUSIVE FEATURES

- GAS FILLED.
- HERMETICALLY SEALED AT HIGH TEMPERATURE.
- RUGGED HIGH ALUMINA CERAMIC BODY.
- PRECISION METAL ELECTRODES.
- NO MAINTENANCE.
- NO OBSTRUCTING TUBULATION.
- NO RADIOACTIVE PROMPTING.
- EXTREMELY FAST RESPONSE, MINIMUM OVERSHOOT (SEE FIG. 1).
- INSENSITIVE TO LIGHT.
- 10,000 AMPERE SURGE CAPABILITY.
- INTERELECTRODE CAPACITANCE < 0.5 pf (BASIC BODY).
- INSULATION RESISTANCE GREATER THAN ONE MILLION MEGOHMS TYPICAL.
- BILATERAL OPERATION, INSENSITIVE to POLARITY.
- SMALL SIZE: 5/16" DIA. X 11/32" LONG.
- SHELF LIFE TESTED.
- 100% VOLTAGE BREAKDOWN TESTED.
- DELIVERY FROM STOCK.
- WEIGHT: 0.05 OUNCES.

APPLICATIONS

THE JOSLYN MSP® SPARK GAPS ARE USED TO PROTECT AGAINST SURGES DUE TO:

- SWITCHING
- STATIC
- CORONA
- EMP
- IONIZATION
- BREAKERS CLOSING
- REFLECTED WAVES
- SYSTEM FAULTS
- FUSE BLOWING
- MOTOR STARTING
- ARC WELDING
- BREAKERS OPENING
- CAPACITIVE DISCHARGE
- CONTACT WITH FOREIGN CIRCUITS
- LIGHTNING (INDUCED OR CONDUCTED)

THE MSP® UNITS ARE USED TO PROTECT:

- SOLID STATE CIRCUITRY
- RELAY COILS
- SENSITIVE EQUIPMENT
- TRAFFIC CONTROLLERS
- RAILROAD CIRCUITRY
- COMPUTERS
- TELEPHONE CIRCUITS
- OPEN WIRE CARRIERS
- RECTIFIERS
- TRAVELING WAVE TUBES
- CARRIER CIRCUITS
- MICROWAVE AND RADIO EQUIPMENT
- FIRE ALARMS
- MODULATORS
- PYROTECHNIC DEVICES

THEY MAY BE USED TO REPLACE:

- CARBON BLOCK ARRESTERS
- OPEN AIR GAPS
- FRAGILE GAPS
- RADIOACTIVATED GAPS
- LIGHT SENSITIVE GAPS
- HIGH MAINTENANCE PROTECTIVE DEVICES
- MECHANICALLY INCOMPATIBLE GAPS
- MECHANICAL SWITCHES

THEY MAY BE USED AS ACTIVATION DEVICES IN:

- PYROTECHNIC DEVICES
- LAMP STARTING CIRCUITS
- LASER PULSERS

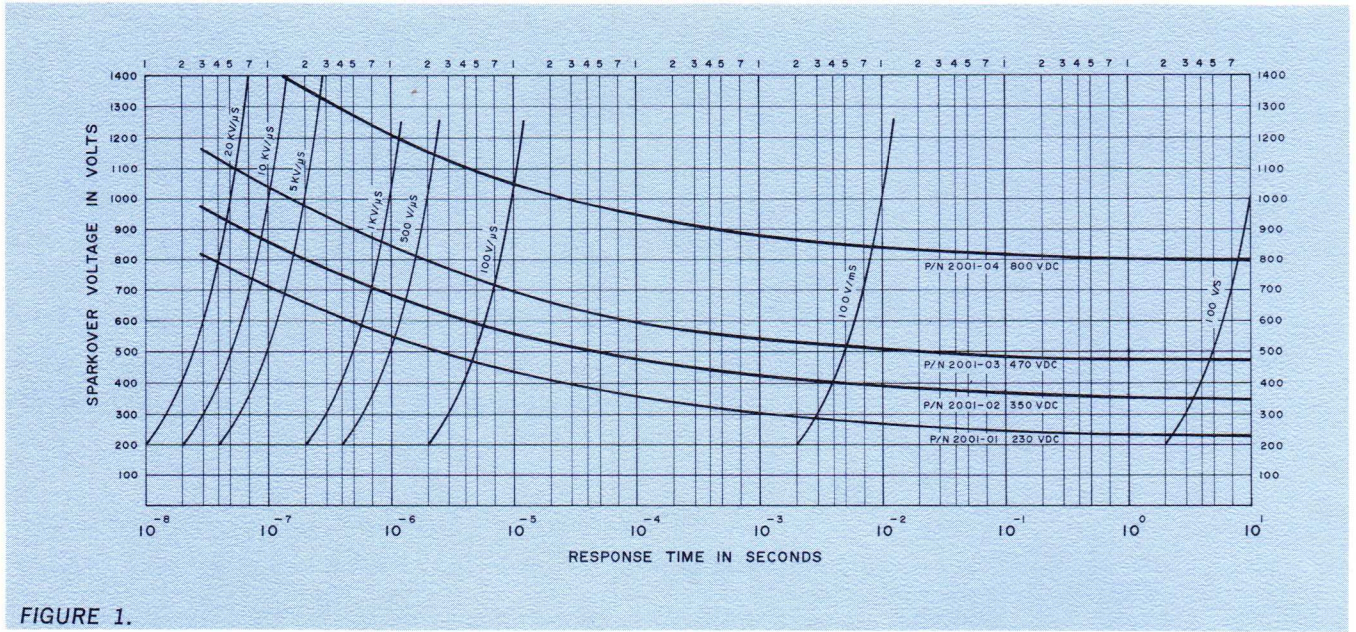
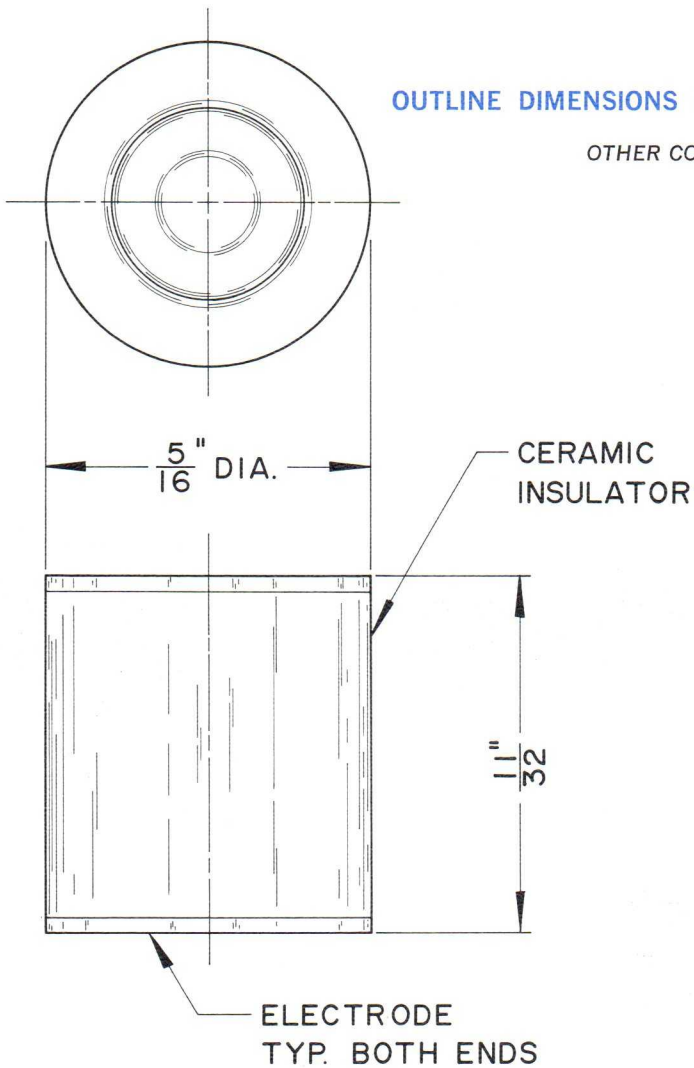

FIGURE 1.



OUTLINE DIMENSIONS FOR BASIC MSP®

OTHER CONFIGURATIONS AVAILABLE

SPECIALS THE MSP® SPARK GAP IS AVAILABLE WITH VARIOUS TERMINALS, CONFIGURATIONS, AND VOLTAGE RATINGS UP TO 3000 V DC. CONSULT FACTORY.

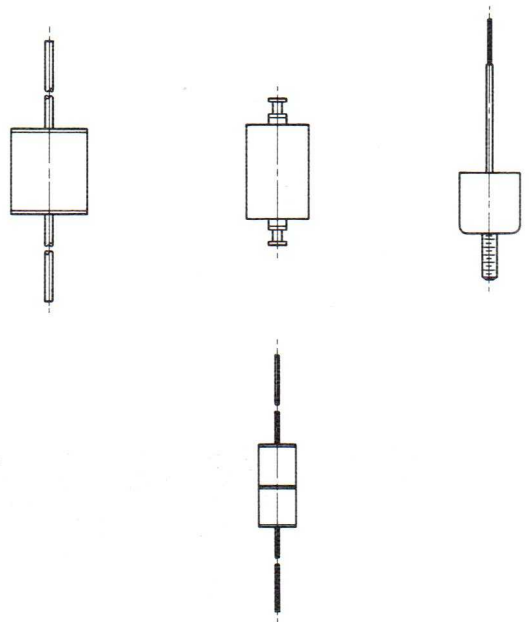

RESPONSE CURVES FOR MSP® GAPS THESE VOLT-TIME CURVES SHOW FRONT-OF-WAVE BREAKDOWN CHARACTERISTICS OF THE JOSLYN MSP® SPARK GAPS. EXAMPLES OF OPERATION: AT AN APPLIED IMPULSE VOLTAGE OF 10 KV PER MICROSECOND RATE-OF-RISE, THE JOSLYN 2001-01 PROTECTOR FIRES AT 730 V AND WITHIN 0.08 MICROSECONDS. AT 500 V PER MICROSECOND, THE 2001-02 CLAMPS AT 670 V AND WITHIN APPROXIMATELY 1 MICROSECOND.

THE MSP® SPARK GAP PROVIDES NANOSECOND OPERATION ON FAST RAMP VOLTAGES, AND OPERATES EFFICIENTLY AND PRECISELY ON ANY RAMP VOLTAGE. (FIG. 1)

TECHNICAL SPECIFICATIONS FOR MSP® SPARK GAPS

VOLTAGE RATINGS: 230 V DC, 350 V DC, 470 V DC, 800 V DC, $\pm 15\%$; VOLTAGE RATINGS TO 3000 V. CONSULT FACTORY.

DISCHARGE CURRENT RATING: 10 OPERATIONS AT 10,000 AMPERES (10 X 20 MICROSECOND).
REPEATED DISCHARGE 1000 MFD CAPACITOR CHARGED TO 750 V.
REPEATED DISCHARGE 300 AMPERES (1 X 250 MICROSECOND).

RESPONSE: SEE FIGURE 1.

OPERATION: SELF-RESTORING.

INSULATION RESISTANCE: GREATER THAN 10^6 MEGOHMS AT 150 V DC.

INTERELECTRODE CAPACITANCE: < 0.5 pf (BASIC BODY).

TEMPERATURE RANGE OF OPERATION: -100°F TO 400°F .

THERMAL SHOCK: 5 CYCLES OF HEAT AND COLD; EACH CYCLE CONSISTS OF 15 MIN. AT 400°F FOLLOWED BY 15 MIN. IN ICE WATER AND BACK TO 400°F FOR NEXT CYCLE.

IMPULSE SHOCK: 1000 G ON 0.3 ± 0.1 MILLISECOND WAVE.

WEIGHT: 0.05 OUNCES.

BODY DIMENSIONS: NOMINAL $5/16''$ DIA. X $11/32''$ LENGTH.

(See outline dimensions)

SELECTION GUIDE FOR MSP[®] SPARK GAPS

JOSLYN MODEL	Nominal DC Sparkover Voltage $\pm 15\%$	Impulse Sparkover Voltage*		Minimum Holdover Voltage	Wire Leads	SIZE dia. x length
		at 10 kv/ μ s rate-of-rise	at 500 v/ μ s rate-of-rise			
2001-01	230	730	540	115	none	5/16" x 11/32"
2001-02	350	870	670	175	none	5/16" x 11/32"
2001-03	470	1030	810	235	none	5/16" x 11/32"
2001-04	800	1390	1140	400	none	5/16" x 11/32"
2001-06	230	730	540	115	yes	5/16" x 11/32"
2001-07	350	870	670	175	yes	5/16" x 11/32"
2001-08	470	1030	810	235	yes	5/16" x 11/32"
2001-09	800	1390	1140	400	yes	5/16" x 11/32"

* Taken from volt-time curves previous page (FIGURE 1.)

Note: Other ratings, terminal mountings, and configurations made to order. Consult factory.

JOSLYN SPARK GAPS . . . A TYPE FOR EVERY APPLICATION The extent of the Joslyn line of Precision Spark Gaps is such that there is virtually a device for every application. The basic Miniature Surge Protector group featured in this brochure has over 61 different types, for example. Exotic and unusual spark gaps include units which employ spinning arcs to eliminate electrode beading, clip-mounted units and designs which provide EMP (Electro-Magnetic Pulse) protection per AF BSD 62-83. In addition, the design, development, and manufacturing experience of Joslyn is available for custom-designed units for your "special" situation. Please consult the factory.

In the interest of brevity, the following is only a partial listing of standard spark gaps available from Joslyn, in addition to the MSP[®] units. Please consult the factory should your requirements point to a device featured elsewhere.

Joslyn Model No.	Max. Surge Current ka 10 x 20/ μ s	DC Breakdown Volts $\pm 15\%$	Impulse Sparkover Typical 10 kv/ μ s	Inter-Electrode Capacitance pf	Insulation Resistance m Ω	Max. space envelope dia. — h.
2001-28	1	> 750	<2000*	<2	>10,000	1/2" x 1 3/16"
2001-29	1	>1100	<2000*	<2	>10,000	1/2" x 1 3/16"
2001-30	1	> 450	<1200*	<2	>10,000	1/2" x 1 3/16"
2001-31	5	230	875	3.5 max.	>1000	1/2" x 1/2"***
2001-32	5	350	1100	3.5 max.	>1000	1/2" x 1/2"***
2001-33	5	470	1300	3.5 max.	>1000	1/2" x 1/2"***
2001-34	5	800	1600	3.5 max.	>1000	1/2" x 1/2"***
2001-35	5	1000	2000	3.5 max.	>1000	1/2" x 1/2"***
2002-01	40	250	—	<8	>1000	7/8" x 2 1/2"
2002-06	40	2000	—	<8	>1000	7/8" x 2 1/2"
2003-01	40	L-L220 L-g400	— —	L-L<5 L-g<8	>1000	7/8" x 4 1/2"
2003-02	40	L-L230 L-g275	— —	L-L<5 L-g<8	>1000	7/8" x 4 1/2"
2008-02	20	250	—	<4	>1000	1 3/8" x 2 3/8"
2008-03	20	250	—	<4	>1000	1 3/8" x 2 3/8"

* 50 kv/ μ s

** with 6-32 gnd. stud., 5/16/g.

DEFINITIONS

WAVESHAPE DESIGNATION OF A SURGE THE WAVESHAPE OF A SURGE OF CURRENT OR VOLTAGE IS DESIGNATED BY A COMBINATION OF TWO NUMBERS. THE FIRST IS AN INDEX OF THE WAVEFRONT AND EXPRESSED IN MICROSECONDS FROM ZERO TO THE PEAK OF THE WAVE. THE SECOND NUMBER IS AN INDEX OF THE WAVETAIL AND ALSO EXPRESSED IN MICROSECONDS FROM ZERO TO THE INSTANT THAT THE WAVETAIL REACHES ONE-HALF OF THE CREST OR PEAK VALUE. EXAMPLE: 10 X 20 MICROSECOND WAVE.

IMPULSE SPARKOVER VOLTAGE THE IMPULSE SPARKOVER VOLTAGE OF A SPARK GAP IS THE HIGHEST VALUE OF VOLTAGE ATTAINED BY AN IMPULSE OF A DESIGNATED WAVESHAPE AND POLARITY APPLIED ACROSS ITS TERMINALS PRIOR TO THE FLOW OF DISCHARGE CURRENT.

DISCHARGE CURRENT THE DISCHARGE CURRENT OF A SPARK GAP IS THE SURGE WHICH FLOWS THROUGH THE SPARK GAP WHEN SPARKOVER OCCURS.

FOR ASSISTANCE FOR SPECIFIC APPLICATION INFORMATION AND ASSISTANCE, REFER TO THE JOSLYN ENGINEERING APPLICATION WORKSHEET OR CONTACT THE FACTORY.

JOSLYN QUALITY CONTROL POLICY QUALITY CONTROL PROCEDURES IN FORCE AT JOSLYN ELECTRONICS SYSTEMS MEET THE RIGID REQUIREMENTS OF MIL-Q-9858A AND BOEING DI-8000A.

OTHER JOSLYN PRODUCTS (Typical)

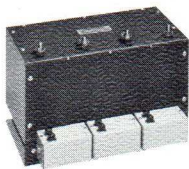

1420-01
3-PHASE AC
PROTECTOR

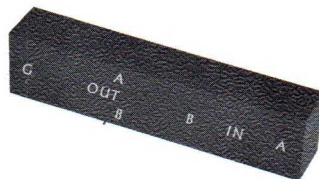

1635-02
DATA INPUT
PROTECTOR



1625-01
OPEN WIRE TRANSMISSION
LINE PROTECTOR



JOSLYN

ELECTRONIC SYSTEMS

A DIVISION OF JOSLYN MFG. AND SUPPLY CO.

SANTA BARBARA RESEARCH PARK
P. O. BOX 817
GOLETA, CALIFORNIA 93017
TELEPHONE (805) 968-3551

JOSLYN

TECHNICAL DATA

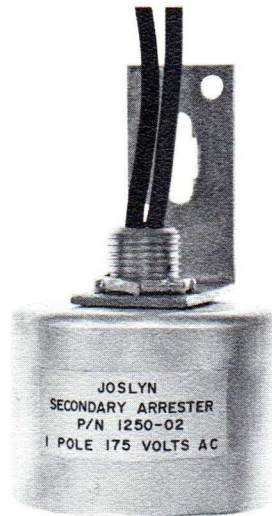

"1/2 ACTUAL SIZE"

SPECIFICATIONS

1. Arrester Voltage Rating: 0-175 Volts rms.
2. Nominal System Voltage on which Arresters may be used: 120 Volts rms, line to ground.
3. Minimum AC Sparkover Voltage: 265 Volts rms.
4. Impulse Sparkover Voltage:

Rate-of-rise of Test Voltage kV/ μ sec	kV Crest	
	avg	max
10	1.0	1.2
0.5	0.72	0.86

5. Discharge Voltage for 10x20 or 8x20 μ sec discharge current wave:

amperes	kV Crest	
	avg	max
1,000	0.90	1.00
1,500	1.00	1.10
5,000	1.20	1.32
10,000	1.40	1.54

6. Power Consumption: None
7. Operating Temperature Range: -65°F to +165°F.
8. Maximum Operating Altitude: 15,000 feet.
9. Construction: Metal case with wire leads. Case is insulated from circuit. Discharges are totally contained within the envelope. No external corona, arcing or venting.
10. Meets specifications: NEMA LA-1, IEEE No. 28-USAS C62.1

MODEL 1250-02

SURGITRON®

SECONDARY ARRESTER

0-175 V RMS, 60 Hz

OUTLINE DIMENSIONS

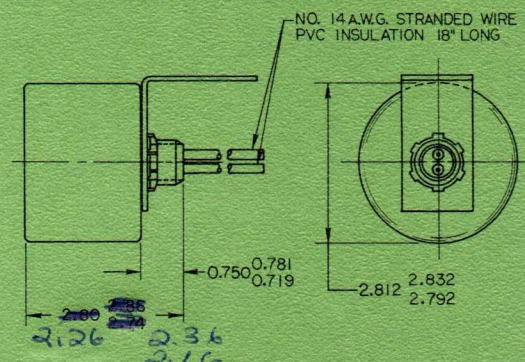

CONNECTION DIAGRAMS

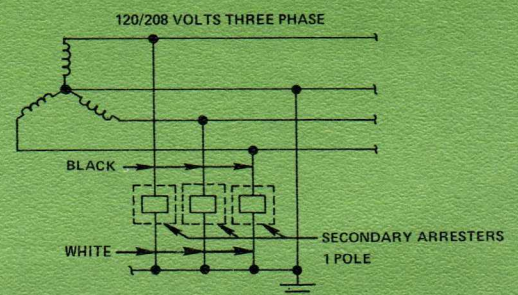
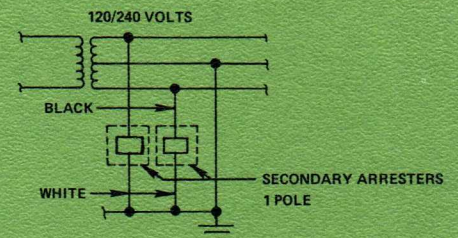
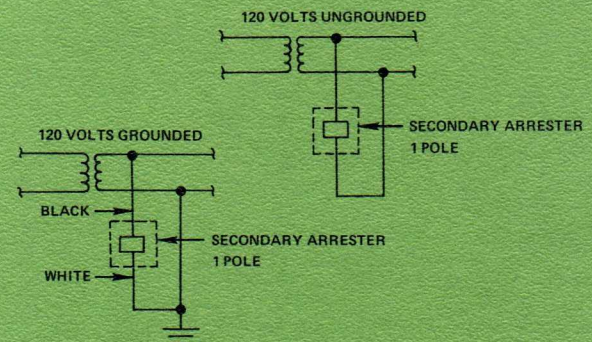

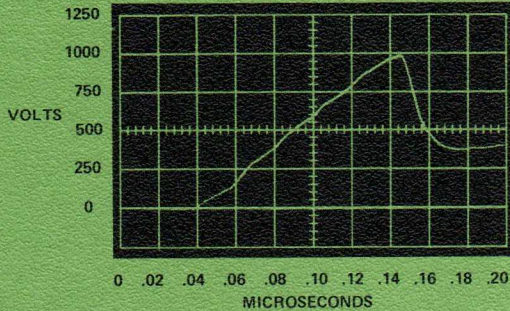

IMPULSE VOLTAGE oscillogram illustrates the voltage breakdown on front of wave of 10,000 volts per microsecond rate-of-rise. The average breakdown occurs at 1,000 volts.

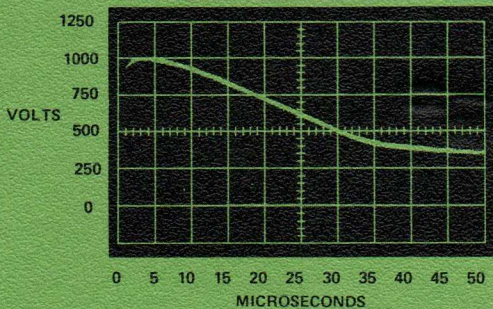

DISCHARGE VOLTAGE oscillogram illustrates the IR on a 10x20 μ sec current surge of 1500 amperes. The average breakdown occurs at 1,000 volts.

The Model 1250-02 Secondary Arrester is recommended for protection against overvoltages caused by switching surges or lightning discharges. It functions at lower impulse sparkover and discharge voltages than commonly available arresters, thus, providing better protection for electrical and electronic equipment. It features high discharge current capacity and power-follow current capability. Also available are the Model 1250-03 containing two 1250-02 arresters in a single case for use with 120/240 volt circuits and the Model 1250-04 containing three 1250-02 arresters in a single case for use with 120/208 volt 3 phase circuits.

DEFINITIONS

LIGHTNING AND ELECTRICAL SURGE ARRESTER

A protective device for limiting surge voltages on equipment by discharging or bypassing surge current. It prevents continued flow of follow current to ground and is capable of repeating these functions.

SURGE

A surge in an electrical circuit is a transient wave of current, potential, or power.

WAVESHAPES DESIGNATION OF A SURGE

The waveshape of a surge of current or voltage is designated by a combination of two numbers. The first number is an index of the wavefront expressed in microseconds from zero to the peak of the wave. The second number is an index of the wavetail also expressed in microseconds from zero to the instant that the wavetail reaches one-half of the crest or peak value. Example: 10 x 20 microsecond wave.

POWER FREQUENCY SPARKOVER VOLTAGE

The power-frequency sparkover voltage of an arrester is the rms value of the lowest power-frequency sine-wave voltage that will cause sparkover when applied across its terminals.

IMPULSE SPARKOVER VOLTAGE

The impulse sparkover voltage of an arrester is the highest value of voltage attained by an impulse of a designated waveshape applied across its terminals prior to the flow of discharge current.

DISCHARGE CURRENT

The discharge current of an arrester is the surge current which flows through the arrester when sparkover occurs.

DISCHARGE VOLTAGE

The discharge voltage of an arrester is the voltage that appears across its terminals during passage of discharge current.

FOLLOW (POWER) CURRENT

The follow current of an arrester is the current from the connected power source which flows through the arrester during and following the passage of the surge current.



JOSLYN
ELECTRONIC SYSTEMS

SANTA BARBARA RESEARCH PARK
P. O. BOX 817
GOLETA, CALIFORNIA 93017
TELEPHONE (805) 968-3551

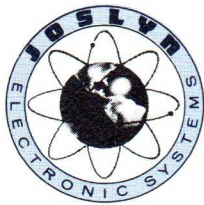

JOSLYN

ELECTRONIC SYSTEMS

1400 SERIES

A C PROTECTORS

3 PHASE, 50/60 Cy.

250 VOLTS RMS MAX.

LIGHTNING AND ELECTRICAL SURGE PROTECTORS

GROUNDING "Y"
ONLY

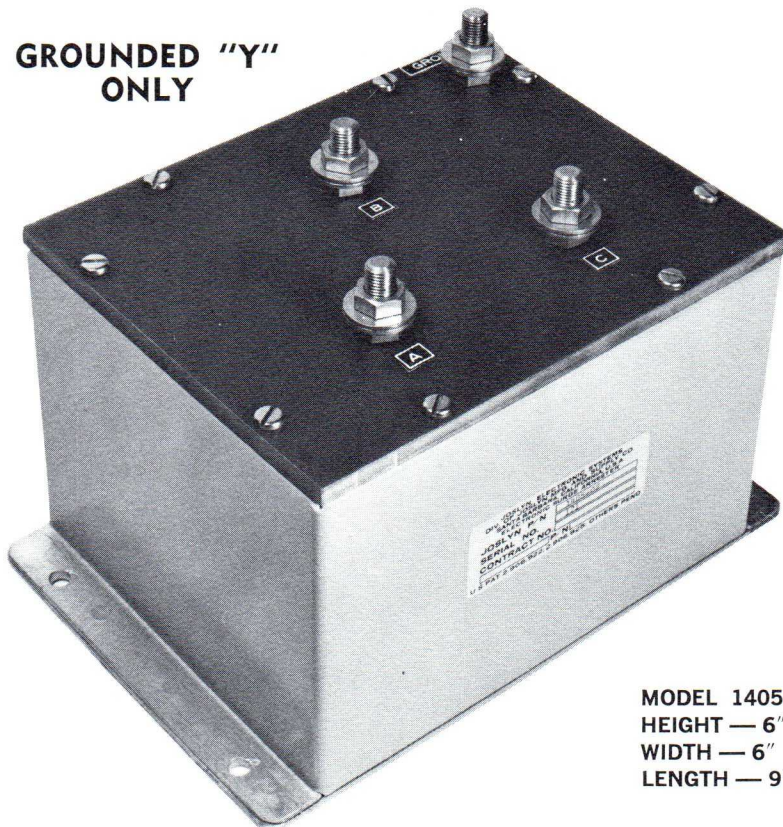

MODEL 1405-02
HEIGHT — 6"
WIDTH — 6"
LENGTH — 9"

DESCRIPTION

The Joslyn lightning and electrical surge protector, model 1405-02, is designed for use on power systems of any kva rating, 3 phase wye, 208 volts 50/60 cycles. The purpose of this protector is to limit surge voltages and prevent damage to electrical and electronic equipment by discharging or bypassing the harmful transients.

The protector also prevents the continued flow of follow current by the use of special techniques. The follow current is extinguished on the first current zero point of the 60-cycle wave. This protector also offers very low clamping levels and an unusually long service life.

EXCLUSIVE FEATURES

ULTRAFAST PRECISION RESPONSE:

Less than 0.4 microsecond time required to clamp a transient voltage with a ramp of 10 kv per microsecond to a safe value of less than 175 volts.

PROVIDES MAXIMUM EQUIPMENT PROTECTION:

Precision response and high surge current capacity guarantees maximum protection for all sensitive electronic circuits, particularly those employing solid-state components (diodes, transistors, SCR's, etc.).

SLOW-RISING WAVE RESPONSE:

Maximum reliability in the sensing and clamping of switching transients or overvoltage surges to a value of about 160% of the rms value of the line voltage.

LINE INSERTION LOSS:

No loss or power consumption as the device is passive and contains no moving parts.

**EXCLUSIVE
FEATURES
(Continued)**

**OPERATIONAL
LIFE EXPECTANCY:**

A minimum of 2,000 operations, at a magnitude of 10,000 amperes (10 x 20 microsecond waveshape) surge current discharge and resulting power follow current per phase.

MAINTENANCE

No inspection or maintenance is required.

**VENT-FREE
CONSTRUCTION:**

The device is hermetically sealed. All gases and other arcing phenomena are contained within the sealed enclosure.

**SPECIAL
ENCLOSURES:**

Special enclosures are available. Prices on request.

OTHER AC MODELS

See descriptive bulletins on the 1200 Series Single Phase and 1400 Series Three Phase Protectors.



APPLICATIONS

The model 1405-02 ac surge protector will safeguard the following type of circuits and equipment against surge conditions:

- Solid-state electronic equipment using semi-conductors.
- AC-powered instrumentation.
- AC input power supplies to microwave stations as well as other telephone, railroad, pipeline, or communication base stations.
- Low insulation level electrical and electronic equipment, including vulnerable fine-wire relay coils.
- Critical power control circuits at military installations involving missile firing and guidance control.

CONNECTION DIAGRAM

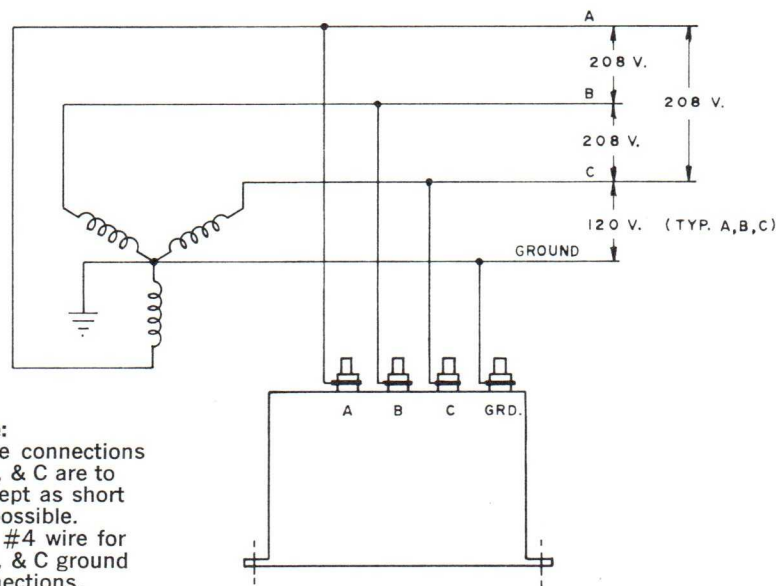

OUTLINE DIMENSIONS

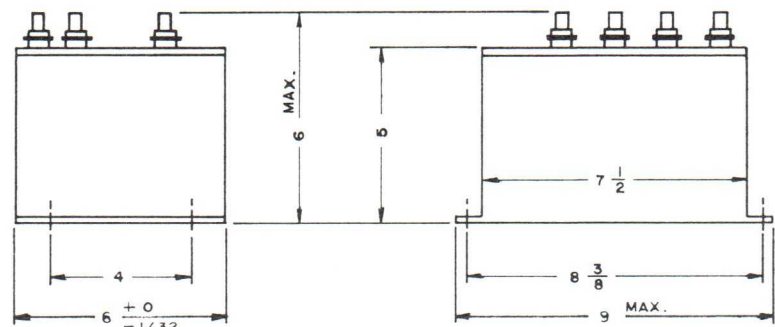

WEIGHT: 12 LBS. MAX.

OSCILLOGRAMS OF ARRESTER RESPONSE

IMPULSE VOLTAGE

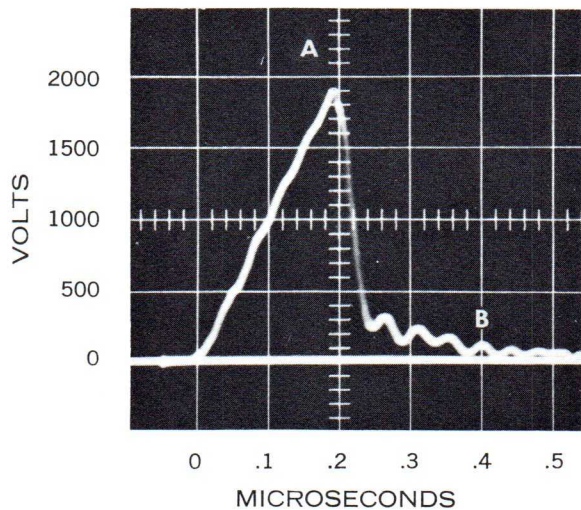

The impulse voltage (above) illustrates the fast response of the protector. For example, an impulse voltage applied at a 10,000 volt per microsecond rate of rise will result in the breakdown voltage shown at point "A". This voltage clamping at less than 2000 volts occurs in less than 0.2 microseconds. The voltage spike is further reduced to less than 175 volts as shown at point "B" within 0.4 microseconds.

DISCHARGE VOLTAGE

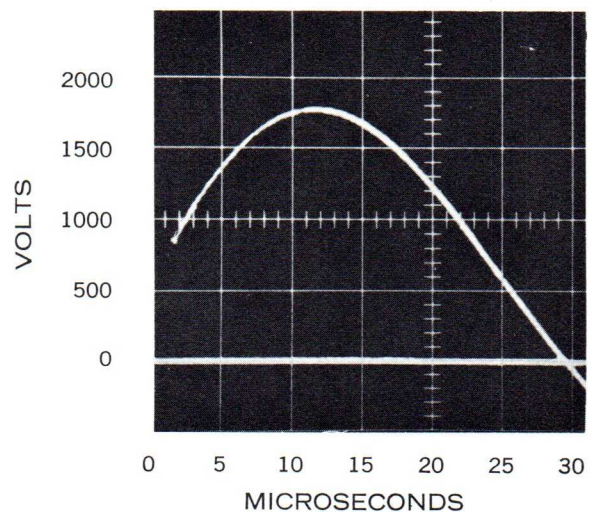

This oscillogram illustrates the effective clamping of the discharge voltage appearing across the protector terminals, when a discharge current of 10,000 amps on a 10 x 20 microsecond wave shape flows through the protector. The peak discharge voltage value is less than 2000 volts.

TECHNICAL SPECIFICATIONS

- 1. AC SPARKOVER VOLTAGE:** 175 volts rms, line-to-ground
On surges with slow rates-of-rise clamping begins at approximately 250 volt peak.
- 2. IMPULSE SPARKOVER VOLTAGE:** Less than 2 kv in less than 0.2 microsecond.
On a rate-of-rise surge of 10 kv per microsecond of either polarity.
- 3. DISCHARGE VOLTAGE:** Less than 2 kv with an applied discharge current of 10,000 amperes on a 10 x 20 microsecond waveshape.
- 4. RATED NUMBER OF OPERATIONS:** Minimum of 2,000 per phase
A single operation consists of a 10,000 ampere discharge current (10 x 20 microsecond waveshape) and the resulting power-follow current which automatically extinguishes at first current zero (within one half-cycle).
- 5. EXTREME DUTY DISCHARGE CAPACITY:** 65,000 amperes (10 x 20 microsecond waveshape) followed by a 75 ampere square wave surge of 1,000 microseconds duration.
- 6. MODE OF OPERATION:** Automatic and self-restoring
The unit is on duty at all times. There is no loss of duty during the one-half cycle restoring period and it will effectively operate on any surge occurrence of either slow or very fast rate-of-rise.
- 7. ZERO INSERTION LOSS:**
The protector is a passive device. No energy-consuming components are used.
- 8. EXTENDED TEMPERATURE RANGE:**
The unit will operate with full efficiency throughout a temperature range of -40°F to 160°F .
- 9. ALTITUDE RANGE:** Maximum operational altitude of 15,000 feet.
- 10. ENCLOSURE DETAILS:**
Sheet metal enclosure with insulating terminal board. Special enclosures are available.

DEFINITIONS

LIGHTNING AND ELECTRICAL SURGE PROTECTOR

A protective device for limiting surge voltages on equipment by discharging or bypassing surge current. It prevents continued flow of follow current to ground and is capable of repeating these functions.

SURGE

A surge in an electrical circuit is a transient wave of current, potential, or power.

WAVESHAPES DESIGNATION OF A SURGE

The waveshape of a surge of current or voltage is designated by a combination of two numbers. The first is an index of the wavefront and expressed in microseconds from zero to the peak of the wave. The second number is an index of the wavetail and also expressed in microseconds from zero to the instant that the wavetail reaches one-half of the crest or peak value. Example: 10 x 20 microsecond wave.

IMPULSE SPARKOVER VOLTAGE

The impulse sparkover voltage of an arrester is the highest value of voltage attained by an impulse of a designated waveshape and polarity applied across its terminals prior to the flow of discharge current.

DISCHARGE CURRENT

The discharge current of an arrester is the surge current which flows through the arrester when sparkover occurs.

DISCHARGE VOLTAGE

The discharge voltage of an arrester is the voltage that appears across its terminals during passage of discharge current.

FOLLOW (POWER) CURRENT

The follow current of an arrester is the current from the connected power source which flows through the arrester during and following the passage of discharge current.

INFORMATION REQUIRED FOR SPECIAL APPLICATIONS

1. The source of the transient or surge: Lightning strikes, switching, or overvoltage, etc. 2. Description of the transient condition: Peak voltage or current, if known. Single or repetitive pulses. Interval between peaks. Transient waveform information. Are oscillograms available for our analysis? 3. Description of the equipment to be protected: Advise the maximum voltage tolerance of equipment. What is the environment of installation. Type and size of enclosure required. Special connection or knockout? 4. Description of the normal-line power source: Single or three phase. Grounded or ungrounded systems. Voltage and frequency. Short circuit current maximum expected. Circuit impedance to limit fault current. 5. Miscellaneous applicable specifications. Vibration, shock, humidity, etc.

JOSLYN QUALITY CONTROL POLICY

Quality control procedures in force at Joslyn Electronic Systems meet the rigid requirements of MIL-Q-9858A and Boeing D1-8000 A.

JOSLYN

ELECTRONIC SYSTEMS

SANTA BARBARA RESEARCH PARK
P. O. BOX 817
GOLETA, CALIFORNIA 93107
TELEPHONE: 805 968-3551

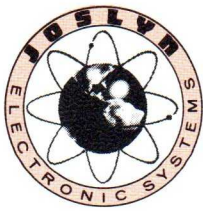

JOSLYN

ELECTRONIC SYSTEMS

2300 SERIES

SIGNAL PROTECTORS

AAR RATING 0-30V DC,

0-175V AC

VISI-GUARD®

LIGHTNING AND ELECTRICAL SURGE PROTECTOR* (SIGNAL TYPE)

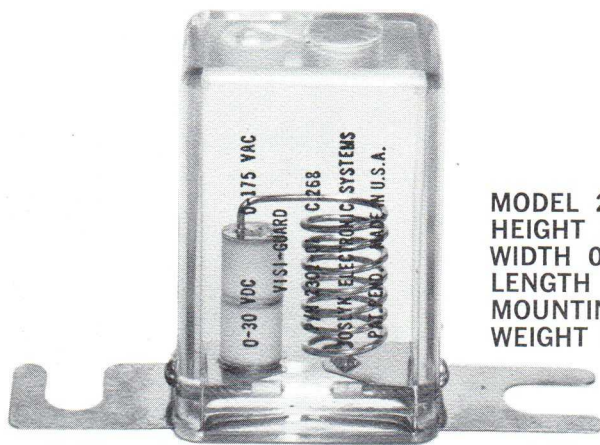

MODEL 2301-01
HEIGHT 1.875"
WIDTH 0.875"
LENGTH (INCL.
MOUNTING TERMINALS) 3"
WEIGHT 2 OUNCES

DESCRIPTION

The Joslyn AAR type signal protector, model 2301-01, is designed for application on 0-30v dc systems, on 0-175 v ac systems, and on 0-260v dc systems where available current is less than 4 amperes. This protector is dimensionally designed to directly replace existing arresters using any base including the molded plastic base, or AAR porcelain base, or the three-post porcelain base.

VISI-GUARD offers extremely low-transient clamping levels — much lower than any other device available. It provides superior protection for signal, communications and for ac and dc power circuits. Its rugged construction extends useful and reliable life to several times that of other devices.

Model 2301-01 is completely sealed and encapsulated against any environment. The spark gap element is hermetically sealed in high alumina ceramic and metal . . . there is no external arcing or emission of gases. The series limiting resistor-inductor is constructed of special metal alloy to withstand heavy surges. The assembly is encapsulated in clear transparent silicone and housed in a clear transparent nonremovable plastic cover. The mounting legs are also the terminals of the protector. These are made of beryllium copper (nickel plated) for resiliency and to carry heavy current. It is impossible to misadjust the internal components with these flexible legs which are slotted on standard 2 3/8" centers.

This surge protector protects against transients from any source such as lightning, induction, static, switching surges, etc.

EXCLUSIVE FEATURES

ULTRA-FAST PRECISION RESPONSE

At 10 kv per microsecond rate-of-rise this protector operates within 0.15 microsecond. Transient clipping starts as low as 500v peak. See comparative response curves for the Joslyn protector and competitive device.

DUTY

Will withstand repeated surges of 5,000 amperes (on standard 10 x 20 microsecond wave-shape) with the usual follow current. On ac applications, the protector will automatically extinguish on the first current zero; on dc applications it is automatically self-extinguishing. These protectors may be used on any kva source within the specified voltage rating.

The number of operations exceeds 50 (three times that of any other device).

CONSTRUCTION

Rugged, hermetically sealed. Permanent see-through cover for easy inspection of components. Flexible mounting legs prevent damage to the unit. Standard size and mountings.

INSULATION RESISTANCE

A minimum of 1,000 megohms between terminals. Therefore, applications may be line-to-line as well as line-to-ground protection. Insertion loss is negligible due to low stray capacitance of the construction and the high resistance of all insulating materials used.

**EXCLUSIVE
FEATURES
(Continued)**

HERMETIC SEALING

No moisture, humidity, dust, or temperature problems. No emission of gases, no burning, no exposed arcing or sparking, no blackening of container.

**WIDE TEMPERATURE
RANGE**

-55°F to +175°F.

NO MAINTENANCE

No adjustments, no cleaning; the cover permanently remains intact. If necessary, replacement of entire unit is easily accomplished; replacement will be indicated by fracture of ceramic and easily seen through the transparent enclosure. Tightening of mounting nuts will not misadjust protector.

OPERATION

When not called to operate, VISI-GUARD presents an "infinite" resistance (greater than 1,000 megohms); when passing surge, this protector provides a path of virtually zero resistance. After surge passage, the insulation resistance restores itself to "infinite" resistance.

On a voltage surge of 10 kv per microsecond rate-of-rise the impulse voltage is less than 1,500 volts (see response curve for other rates-of-rise). On a current surge of 5,000 amperes (10 x 20 microsecond waves) the discharge voltage is 1,650 volts. These values are much less than on any other device available.

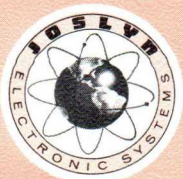

**OSCILLOGRAMS OF
PROTECTOR RESPONSE**

Fig. 1 IMPULSE VOLTAGE

IMPULSE VOLTAGE oscillogram illustrates the voltage breakdown on front of wave of 10,000 volts per microsecond rate-of-rise. The breakdown occurs at less than 1,500 volts (point A) in less than 0.15 microsecond. The voltage is further clamped to less than 200 volts (point B) in less than 0.25 microsecond — an extremely fast response.

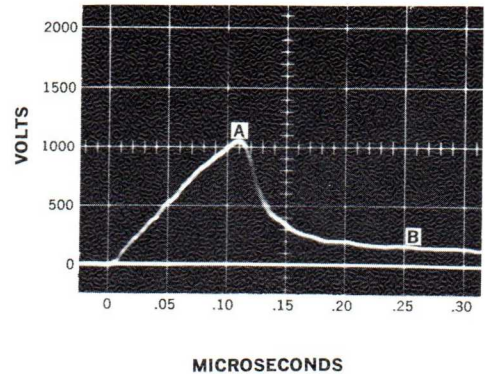
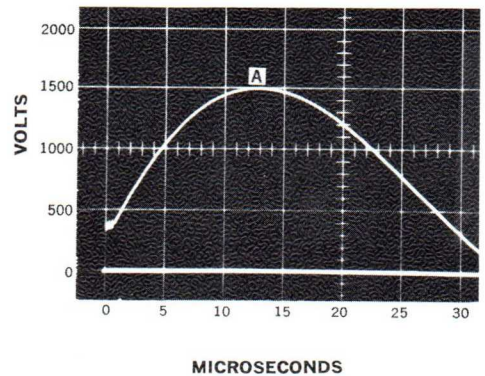

Fig. 2 DISCHARGE VOLTAGE

DISCHARGE VOLTAGE oscillogram demonstrates the maximum value of voltage across the protector terminals of less than 1,650 volts (point A) with 5,000 amperes (10 x 20 microsecond wave-shape) discharge current flowing through the protector.



**Fig. 3 VOLT-TIME
CHARACTERISTICS**

VOLT-TIME curves for Joslyn VISI-GUARD and for other manufacturers' devices.

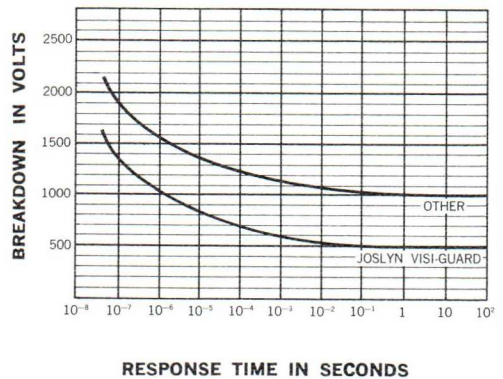

**Fig. 4 REPEATED BREAKDOWN
CHARACTERISTICS**

REPEATED BREAKDOWN CHARACTERISTICS of Joslyn Model 2301-01 indicate low breakdown voltage as well as uniformity in breakdown as shown by 15 successive operations. The rate-of-rise is 200 volts per second, which is considered a static breakdown test.

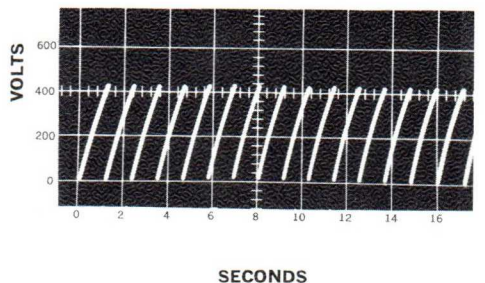

APPLICATIONS

- CTC systems
- Crossings
- Hotbox detectors
- Presence detectors
- Carrier systems
- Telephone and telegraph circuits
- Ac and dc instruments
- Solid-state electronic equipment
- Ac input power supplies
- Critical power control circuits

CONNECTION DESCRIPTION (typical application)

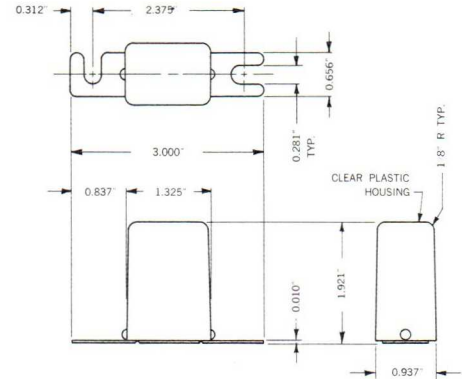
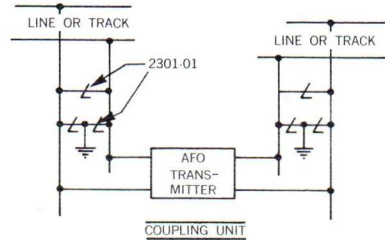

TECHNICAL SPECIFICATIONS

1. **SPARKOVER VOLTAGE:** 500v dc or 350v ac rms.
2. **VOLTAGE RATING:** 0-175v ac; 0-30v dc; 0-260v dc (limited to 4 amperes circuit).
3. **POWER RATING:** Any (except to 4 amperes on 260v dc).
4. **IMPULSE SPARKOVER VOLTAGE:** Less than 1,500v in less than 0.15 microseconds on a rate-of-rise surge of 10 kv per microsecond of either polarity.
5. **DISCHARGE VOLTAGE:** Less than 1,650v with an applied discharge current of 5,000 amperes on 10 x 20 microsecond waveshape.
6. **RATED NUMBER OF OPERATIONS:** Minimum of 50 — a single operation consists of a 5,000-ampere discharge current (10 x 20 microsecond waveshape) and the resulting power-follow current which automatically extinguishes.
7. **EXTREME DUTY DISCHARGE CAPACITY:** 15,000 amperes (10 x 20 microsecond waveshape).
8. **TEMPERATURE RANGE:** -55°F to $+175^{\circ}\text{F}$.
9. **MODE OF OPERATION:** Automatic and self-restoring. The unit is on duty at all times. There is no loss of duty during the restoring period.
10. **ENCLOSURE:** Standard configuration for mounting on AAR boxes; mounting terminals nickel plated. Housing transparent and hermetically sealed against moisture and dust. No explosive flame or gas ports.
11. **INSULATION RESISTANCE:** Minimum 1,000 megohms.

DEFINITIONS

LIGHTNING AND ELECTRICAL SURGE PROTECTOR

A protective device for limiting surge voltages on equipment by discharging or bypassing surge current. It prevents continued flow of follow current to ground and is capable of repeating these functions.

SURGE

A surge in an electrical circuit is a transient wave of current, potential, or power.

WAVESHAPES DEFINITION OF A SURGE

The waveshape of a surge of current or voltage is designated by a combination of two numbers. The first number is an index of the wavefront expressed in microseconds from zero to the peak of the wave. The second number is an index of the wavetail also expressed in microseconds from zero to the instant that the wavetail reaches one-half of the crest or peak value. Example: 10 x 20 microsecond wave.

IMPULSE SPARKOVER VOLTAGE

The impulse sparkover voltage of a protector (arrester) is the highest value of voltage attained by an impulse of a designated waveshape and polarity applied across its terminals prior to the flow of discharge current.

DISCHARGE CURRENT

The discharge current of a protector (arrester) is the surge current which flows through the protector when sparkover occurs.

DISCHARGE VOLTAGE

The discharge voltage of a protector (arrester) is the voltage that appears across its terminals during passage of discharge current.

FOLLOW (POWER) CURRENT

The follow current of a protector (arrester) is the current from the connected power source which flows through the protector during and following the passage of discharge current.

INFORMATION REQUIRED FOR SPECIAL APPLICATIONS

1. SOURCE OF TRANSIENT OR SURGE:

Lightning strikes, switching surges, over-voltages, etc.

2. DESCRIPTION OF THE TRANSIENT:

Peak voltage or current?
Single or repetitive pulses?
Interval between peaks?

3. TRANSIENT WAVEFORM INFORMATION:

Are oscillograms available for our analysis?

4. DESCRIPTION OF THE EQUIPMENT TO BE PROTECTED:

Advise the maximum voltage tolerance of the equipment.
What is the environment of the installation?

5. DESCRIPTION OF THE NORMAL LINE POWER SOURCE:

Single or three phase?
Grounded or ungrounded systems?
Voltage, frequency, and kva rating of the load?
Short circuit current available?
Circuit impedance to limit fault current?

6. MISCELLANEOUS APPLICABLE SPECIFICATIONS

Vibration, shock, humidity, temperature, etc.

HOW TO ORDER

Specify the full model number of the protector and, as a double check, give the full details of use. We also recommend a review of the adjacent list of questions for SPECIAL APPLICATIONS.

JOSLYN QUALITY CONTROL POLICY

Quality control procedures in force at Joslyn Electronic Systems meet the rigorous requirements of MIL-Q-9858A and Boeing D1-8000A.

JOSLYN

ELECTRONIC SYSTEMS

SANTA BARBARA RESEARCH PARK
P. O. BOX 817
GOLETA, CALIFORNIA 93017
TELEPHONE: 805:968-3551

JOSLYN

**DO NOT USE
IN DC CIRCUITS**

**Eliminate
Transient
Damage**

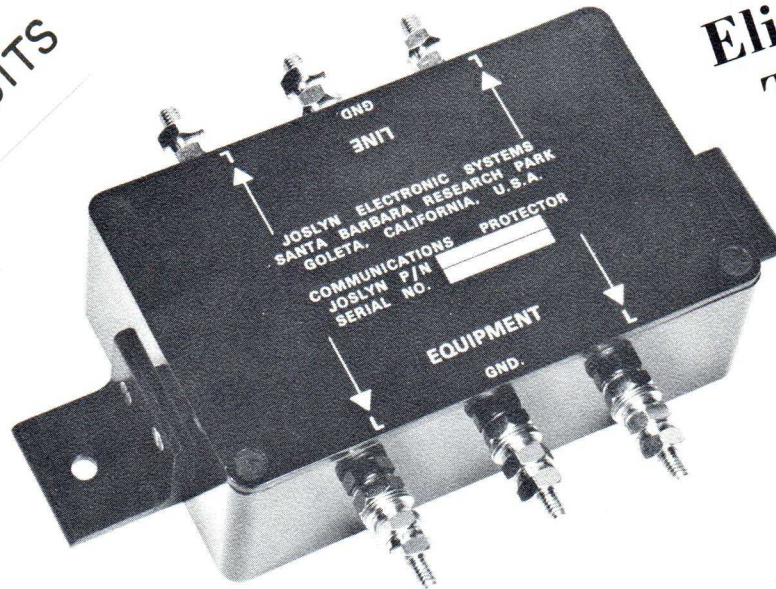

COMMUNICATION AND SIGNAL PROTECTORS

1620 SERIES — BALANCED PAIR

Joslyn 1620 Series Communication and Signal Protectors are designed to positively protect delicate communication, signal, and control equipments from damage due to transients and surges, whatever their origin.

Joslyn protector design techniques efficiently combine fast response, low-clamping level, and the ability to bypass large amounts of transient energy repeatedly and consistently.

The Joslyn 1620 Series of lightning and electrical surge protectors are designed to meet demands for low cost and high degree of protection; and, with the versatility of use on any line impedance, over a wide signal level range, and at frequencies up to 1 Mc. These protectors require no operating power; are strictly passive devices; have no moving parts; are noiseless; have negligible insertion loss; and remain permanently and constantly on duty.

EXCLUSIVE FEATURES

- Ultrafast response
- Low-level clamping
- Large transient energy-handling capability
- Repeatability
- Negligible insertion loss
- Line-to-line and line-to-ground protection
- Temperature compensated
- For use on any line impedance
- Wide choice of operating signal levels
- Automatic - self-restoring
- Unlimited life



Systems Protection in a Nuclear and Space Age Environment

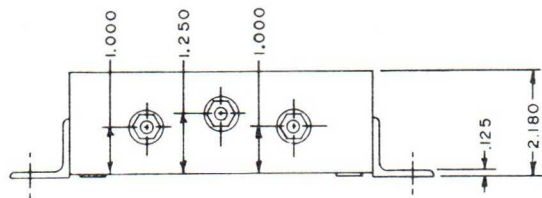
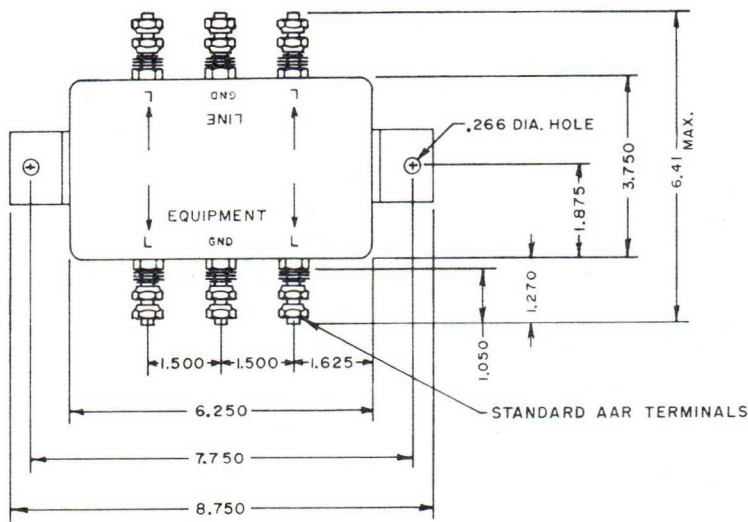

OUTLINE DIMENSIONS
1620 SERIES

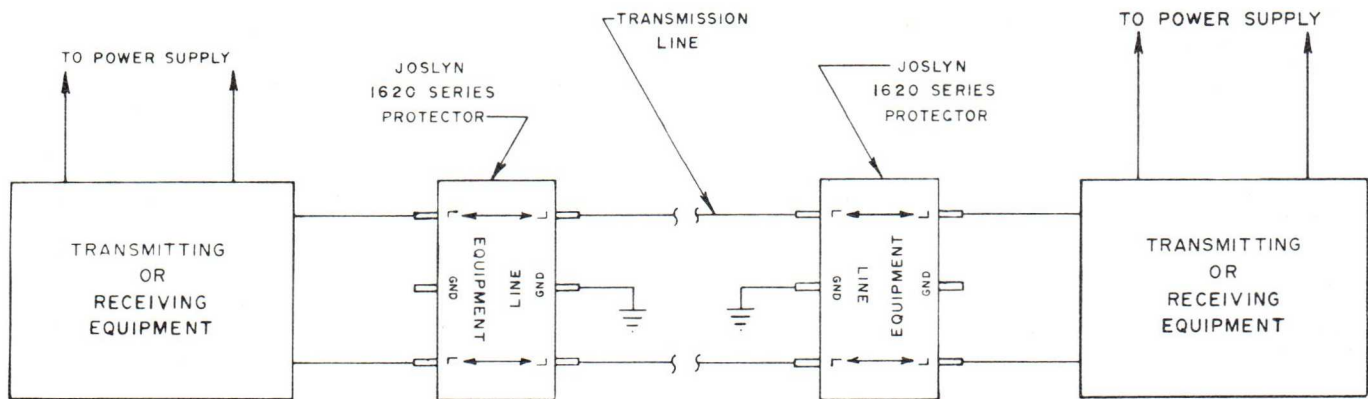

APPLICATION OF JOSLYN 1620 SERIES COMMUNICATION AND SIGNAL PROTECTORS

A pair of Joslyn 1620 Series Protectors connected at each end of the transmission line provides complete and the ultimate in lightning and surge protection to the sending and receiving equipment. Any transient disturbances (lightning, switching, etc.) on the transmission line *will not* get past the 1620 protectors.

Should transient disturbances occur on the power supply end of the communication equipment, the Joslyn 1000, 1200, or 1400 Series protectors will provide positive protection. The 1000 Series are for use with dc power supplies; the 1200 and 1400 Series for ac power supplies. Please consult the factory for additional information.

TYPICAL OSCILLOGRAPHIC RECORDS OF PROTECTOR PERFORMANCE

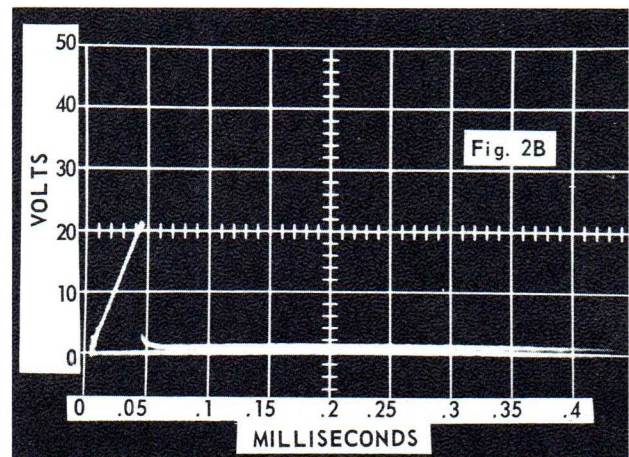
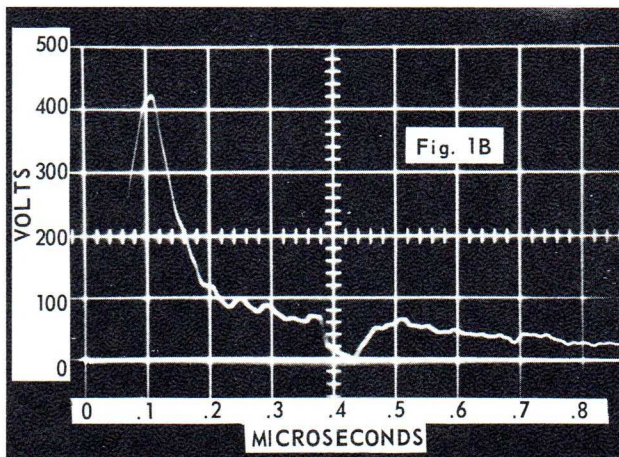
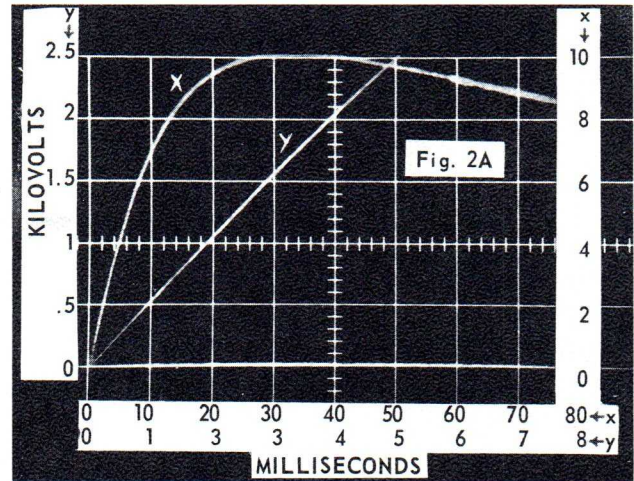
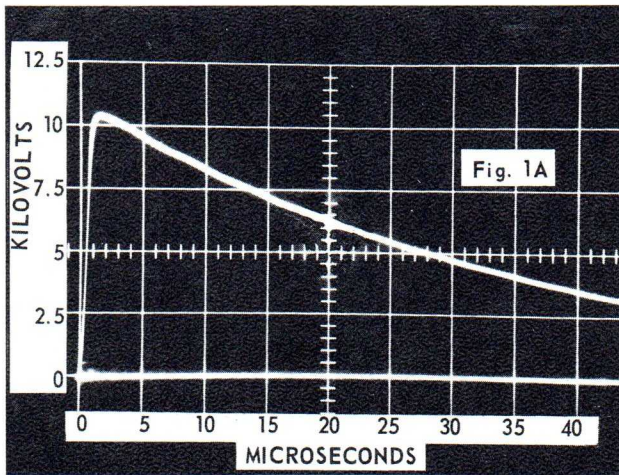

Fig. 1A shows a fast transient of 10 kv/microsecond rate-of-rise applied to the "line" terminals of the Joslyn model 1625-01 protector. Fig. 1B shows the remnants of this transient appearing on the "equipment" terminals. A damaging voltage of 10,500 v was clamped to 120 v in 0.2 microsecond and further down to 20 v in less than 1 microsecond.

Fig 2A shows a slow transient of 500 v/millisecond rate-of-rise and peaking at slightly over 10,000 v (trace "X"). Trace "Y" is an expansion of a portion of the front of the wave of trace "X". This full wave was applied to the "line" terminals of the same protector used in Figs. 1A and 1B (model 1625-01). Fig. 2B shows that at the "equipment" terminals only 21 volts appear.

The above oscillograms depict performance on very fast transients as well as on very slow transients. Whatever may be the nature of the transient, Joslyn's 1620 Series Protectors effectively and expeditiously clamp transients to negligible value. The 1620 Series Protectors bypass very heavy transient energies, have unlimited life, and have no detectable deterioration in operating performance.

SELECTION GUIDE

COMMUNICATION AND SIGNAL PROTECTORS – BALANCED PAIR

Joslyn Model Number*	For Use With Maximum Signal Level**	Insertion Loss at Maximum Signal Level	Voltage at "EQUIPMENT" Terminals With Transient Into "LINE" Terminals		DC Breakdown Voltage
			At 10,000 v/microsec Rate-of-rise	At 500 v/millisecond Rate-of-rise	
1623-01	1.0 v peak	< 0.5 db	< 50 v in < 0.2 microsec	< 5 v in < .02 millisecc	2 v
1624-01	2.0 v peak	< 0.5 db	< 80 v in < 0.2 microsec	< 10 v in < .03 millisecc	4 v
1625-01	10.0 v peak	< 0.5 db	< 120 v in < 0.2 microsec	< 20 v in < .05 millisecc	20 v
1626-01	50.0 v peak	< 0.5 db	< 160 v in < 0.2 microsec	< 110 v in < .2 millisecc	100 v

* Models listed may be used at **any** line impedance and **any** frequency to 1 Mc. Coaxial single-ended models available — consult factory.

** Protectors for signal levels above 50 v available — consult factory.

APPLICATION

Joslyn Communication and Signal Protectors find extensive application in the following areas:

RAILROADS: Used on multiplex carrier circuits, Central Traffic Control systems, hotbox detector circuits, track overlay circuits of all types, crossing predictors, automatic train stop systems, and presence detectors.

TELEPHONE AND ELECTRIC POWER COMPANIES: Used on communication systems' signal carrying circuits, supervisory and control circuits carrying signal information, and for land line control.

PROCESS CONTROL INSTRUMENTATION: Used in conjunction with transistorized amplifiers, solid-state measuring and control instruments, telemetry circuits, multiplexers, and solid-state scanners.

INSTRUMENT PROTECTION IN LABORATORIES AND TEST AREAS: Used to protect input circuits on frequency meters, digital voltmeters, output circuits on signal generators, servo command transient isolation and protection, and data sensing line surge limiting.

TO ELIMINATE THE PROBLEMS CAUSED BY TRANSIENTS AND SURGES ON NEW EQUIPMENT, AS WELL AS ON EQUIPMENT ALREADY IN USE, THE INSTALLATION OF JOSLYN PROTECTORS IS MANDATORY. BY USING THESE PROTECTORS NOW, MANY MONTHS OF TRIAL - AND - ERROR TESTING WILL BE ELIMINATED AND OPERATING COSTS APPROPRIATELY REDUCED. MAKE JOSLYN PROTECTION A PART OF YOUR PREVENTIVE MAINTENANCE PROGRAM.

WARRANTY

The Joslyn Protector is warranted against mechanical and electrical defects for a period of one year from date of shipment from the factory provided it has been installed and used in accordance with the manufacturer's recommendations. Protectors overhauled by Joslyn are warranted against mechanical and electrical defects for a period of one year. Protectors suspected to be defective should be returned to the factory. New parts will be furnished free of charge in exchange for parts which have proved defective. The furnishing of these parts shall constitute fulfillment of the manufacturer's obligation and liabilities. THIS WARRANTY DOES NOT APPLY TO PROTECTORS REPAIRED OR OVERHAULED BY THE USER.



JOSLYN ELECTRONIC SYSTEMS
Division of Joslyn Mfg. and Supply Co.

6868 Cortona Drive, Santa Barbara Research Park
P. O. Box 817, Goleta, California 93017
Telephone: (805) 968-3551

Systems Protection in a Nuclear and Space Age Environment

JOSLYN

**Do Not Use
in DC Circuits**

**Eliminate
Transient
Damage**

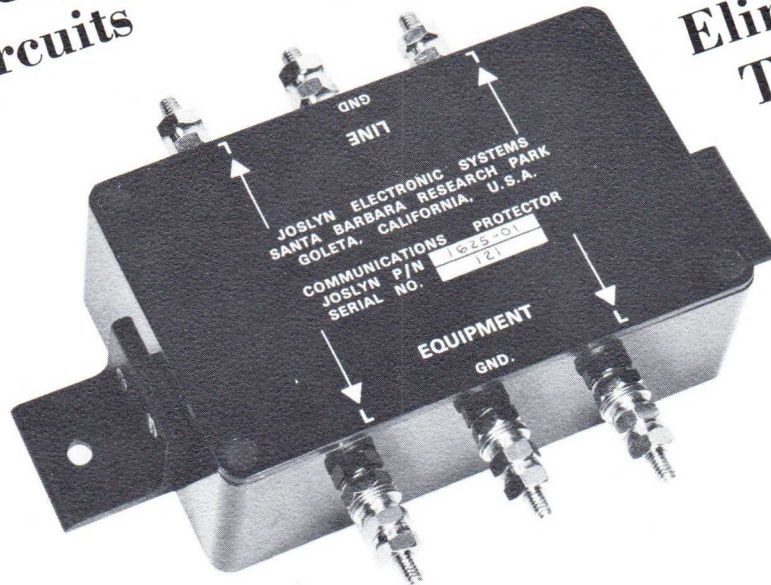

COMMUNICATION AND SIGNAL PROTECTORS

1620 SERIES — BALANCED PAIR

Joslyn 1620 Series Communication and Signal Protectors are designed to positively protect delicate communication, signal, and control equipments from damage due to transients and surges, whatever their origin.

Joslyn protector design techniques efficiently combine fast response, low-clamping level, and the ability to bypass large amounts of transient energy repeatedly and consistently.

The Joslyn 1620 Series of lightning and electrical surge protectors are designed to meet demands for low cost and high degree of protection; and, with the versatility of use on any line impedance, over a wide signal level range, and at frequencies up to 1 Mc. These protectors require no operating power; are strictly passive devices; have no moving parts; are noiseless; have negligible insertion loss; and remain permanently and constantly on duty.

EXCLUSIVE FEATURES

- Ultrafast response
- Low-level clamping
- Large transient energy-handling capability
- Repeatability
- Negligible insertion loss
- Line-to-line and line-to-ground protection
- Temperature compensated
- For use on any line impedance
- Wide choice of operating signal levels
- Automatic - self-restoring
- Unlimited life



Systems Protection in a Nuclear and Space Age Environment

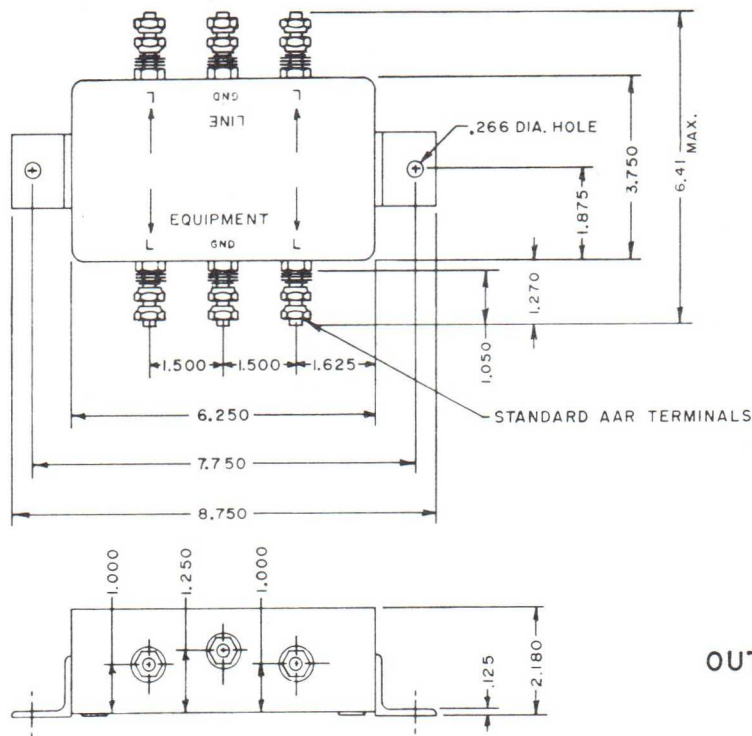

OUTLINE DIMENSIONS
1620 SERIES

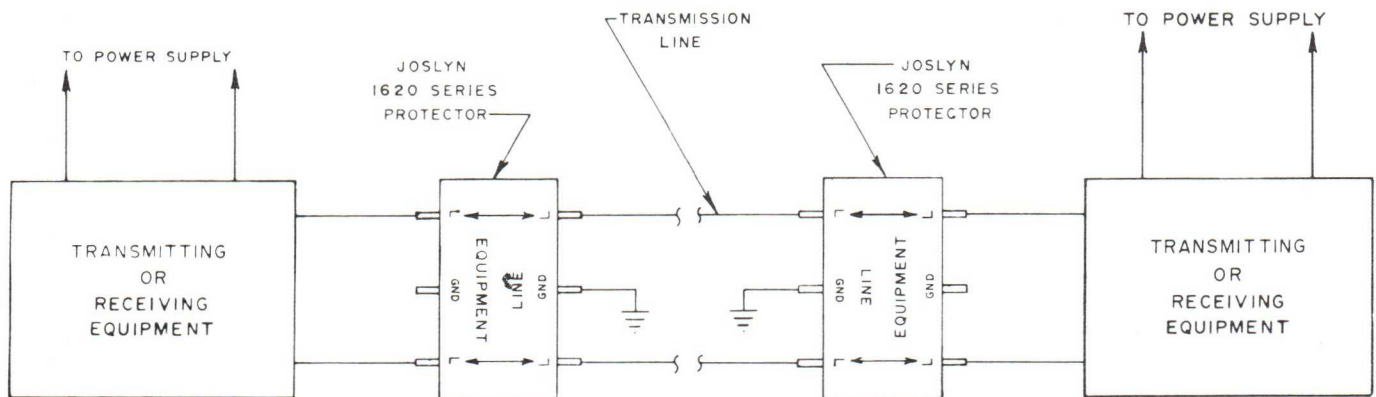

APPLICATION OF JOSLYN 1620 SERIES COMMUNICATION AND SIGNAL PROTECTORS

A pair of Joslyn 1620 Series Protectors connected at each end of the transmission line provides complete and the ultimate in lightning and surge protection to the sending and receiving equipment. Any transient disturbances (lightning, switching, etc.) on the transmission line *will not* get past the 1620 protectors.

Should transient disturbances occur on the power supply end of the communication equipment, the Joslyn 1000, 1200, or 1400 Series protectors will provide positive protection. The 1000 Series are for use with dc power supplies; the 1200 and 1400 Series for ac power supplies. Please consult the factory for additional information.

TYPICAL OSCILLOGRAPHIC RECORDS OF PROTECTOR PERFORMANCE

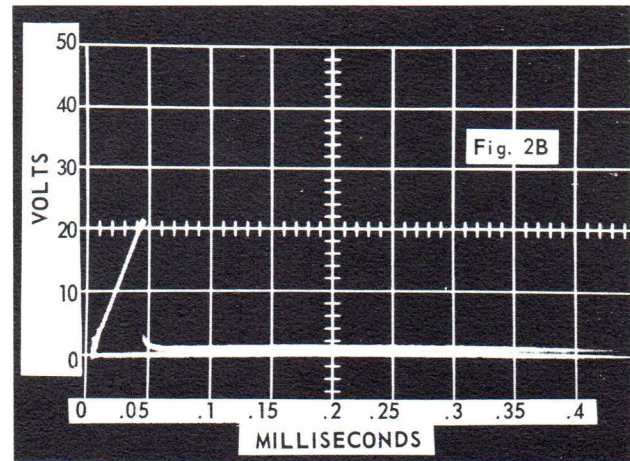
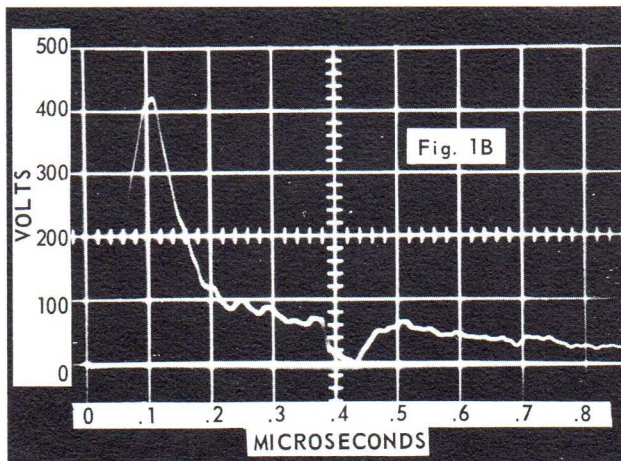
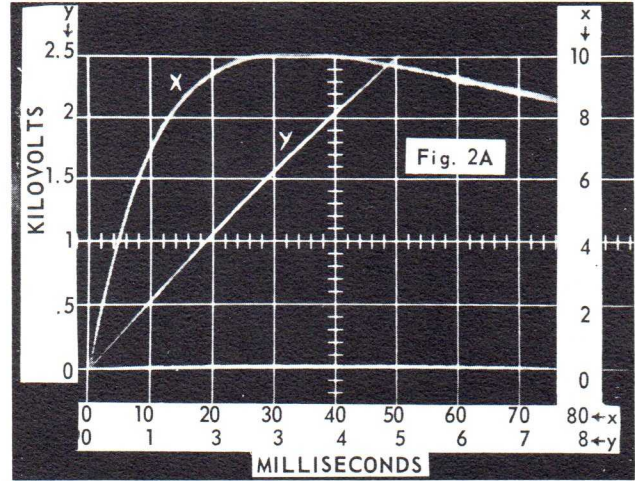
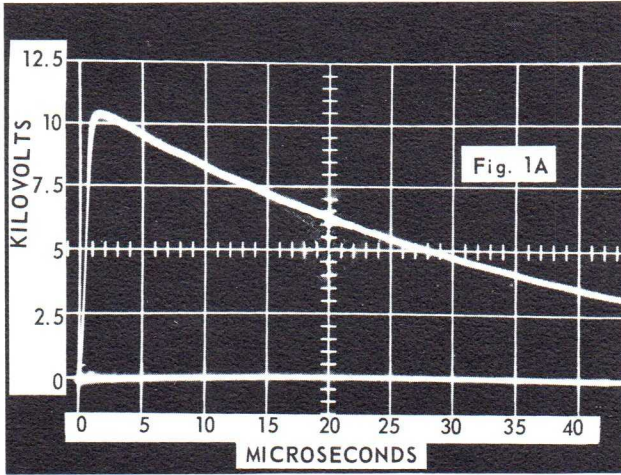

Fig. 1A shows a fast transient of 10 kv/microsecond rate-of-rise applied to the "line" terminals of the Joslyn model 1625-01 protector. Fig. 1B shows the remnants of this transient appearing on the "equipment" terminals. A damaging voltage of 10,500 v was clamped to 120 v in 0.2 microsecond and further down to 20 v in less than 1 microsecond.

Fig 2A shows a slow transient of 500 v/millisecond rate-of-rise and peaking at slightly over 10,000 v (trace "X"). Trace "Y" is an expansion of a portion of the front of the wave of trace "X". This full wave was applied to the "line" terminals of the same protector used in Figs. 1A and 1B (model 1625-01). Fig. 2B shows that at the "equipment" terminals only 21 volts appear.

The above oscillograms depict performance on very fast transients as well as on very slow transients. Whatever may be the nature of the transient, Joslyn's 1620 Series Protectors effectively and expeditiously clamp transients to negligible value. The 1620 Series Protectors bypass very heavy transient energies, have unlimited life, and have no detectable deterioration in operating performance.

SELECTION GUIDE

COMMUNICATION AND SIGNAL PROTECTORS – BALANCED PAIR

Joslyn Model Number*	For Use With Maximum Signal Level**	Insertion Loss at Maximum Signal Level	Voltage at "EQUIPMENT" Terminals With Transient Into "LINE" Terminals		DC Breakdown Voltage
			At 10,000 v/microsec Rate-of-rise	At 500 v/millisecond Rate-of-rise	
1623-01	1.0 v peak	< 0.5 db	< 50 v in < 0.2 microsec	< 5 v in < .02 millisecc	2 v
1624-01	2.0 v peak	< 0.5 db	< 80 v in < 0.2 microsec	< 10 v in < .03 millisecc	4 v
1625-01	10.0 v peak	< 0.5 db	< 120 v in < 0.2 microsec	< 20 v in < .05 millisecc	20 v
1626-01	50.0 v peak	< 0.5 db	< 160 v in < 0.2 microsec	< 110 v in < .2 millisecc	100 v

* Models listed may be used at **any** line impedance and **any** frequency to 1 Mc. Coaxial single-ended models available — consult factory.

** Protectors for signal levels above 50 v available — consult factory.

APPLICATION

Joslyn Communication and Signal Protectors find extensive application in the following areas:

RAILROADS: Used on multiplex carrier circuits, Central Traffic Control systems, hotbox detector circuits, track overlay circuits of all types, crossing predictors, automatic train stop systems, and presence detectors.

TELEPHONE AND ELECTRIC POWER COMPANIES: Used on communication systems' signal carrying circuits, supervisory and control circuits carrying signal information, and for land line control.

PROCESS CONTROL INSTRUMENTATION: Used in conjunction with transistorized amplifiers, solid-state measuring and control instruments, telemetry circuits, multiplexers, and solid-state scanners.

INSTRUMENT PROTECTION IN LABORATORIES AND TEST AREAS: Used to protect input circuits on frequency meters, digital voltmeters, output circuits on signal generators, servo command transient isolation and protection, and data sensing line surge limiting.

TO ELIMINATE THE PROBLEMS CAUSED BY TRANSIENTS AND SURGES ON NEW EQUIPMENT, AS WELL AS ON EQUIPMENT ALREADY IN USE, THE INSTALLATION OF JOSLYN PROTECTORS IS MANDATORY. BY USING THESE PROTECTORS NOW, MANY MONTHS OF TRIAL-AND-ERROR TESTING WILL BE ELIMINATED AND OPERATING COSTS APPROPRIATELY REDUCED. MAKE JOSLYN PROTECTION A PART OF YOUR PREVENTIVE MAINTENANCE PROGRAM.

WARRANTY

The Joslyn Protector is warranted against mechanical and electrical defects for a period of one year from date of shipment from the factory provided it has been installed and used in accordance with the manufacturer's recommendations. Protectors overhauled by Joslyn are warranted against mechanical and electrical defects for a period of one year. Protectors suspected to be defective should be returned to the factory. New parts will be furnished free of charge in exchange for parts which have proved defective. The furnishing of these parts shall constitute fulfillment of the manufacturer's obligation and liabilities. THIS WARRANTY DOES NOT APPLY TO PROTECTORS REPAIRED OR OVERHAULED BY THE USER.

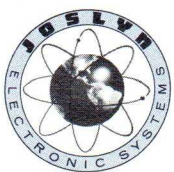

JOSLYN ELECTRONIC SYSTEMS
Division of Joslyn Mfg. and Supply Co.

6868 Cortona Drive, Santa Barbara Research Park
P. O. Box 817, Goleta, California 93017
Telephone: (805) 968-3551

Systems Protection in a Nuclear and Space Age Environment



JOSLYN ELECTRONIC SYSTEMS

DIVISION OF JOSLYN MFG. AND SUPPLY CO.

Santa Barbara Research Park

Reply to:

P. O. Box 817
Goleta, California 93017
Telephone 805 968-3551

A. C. POWER PROTECTOR FUSE RECOMMENDATIONS

It is considered good practice in the electrical field to provide some means of protecting against random conditions that may cause damage to a power system or associated equipment.

Although we have, in the past, allowed the connection of our ac power system protectors to the power line without the use of fuses, we now strongly recommend that the fuses of an appropriate rating be used in each of the "hot" leads connected to our protectors.

The installation of the recommended fuses in no way impairs the high operating efficiency of the Joslyn Lightning and Surge Protectors, but instead offers still another degree of protection.

Most Joslyn AC Protectors are equipped with neon indicator lamps which are illuminated when power is on and the unit is functioning normally. Remote indication is also available. Should a fuse "blow" the indicators will go out to show that the protector has been removed from the circuit.

Following is a list of the fuses recommended for use with various Joslyn AC Protectors.

FUSE RECOMMENDATIONS

<u>JOSLYN NUMBER</u>	<u>FUSE NUMBER</u>	<u>MANUFACTURER</u>
1230-01	TR-45	Chase-Shawmut
1235-01	FRN-35	Bussmann
1405-02		
1240-01	FRN-90	Bussmann
1245-01	CP-6A AWG #4 Cable	Bussmann
1420-01		
1246-01	TR-90	Chase-Shawmut
	FRN-70	Bussmann
1414-06	TRS-100	Chase-Shawmut
	CP-6A AWG #4 Cable	Chase-Shawmut
	KDC	Bussmann
1414-08	KDC	Bussmann
	KCC	Bussmann
1414-09	FRS-45	Bussmann
	TRS-40	Chase-Shawmut
	CP6 AWG #2 Cable	Chase-Shawmut
1414-10	FRN-35	Bussmann
	LEN 50	Economy-Fuse
	TR 40	Chase-Shawmut
	KCY	Bussmann
	KDY	Bussmann

Should any questions arise regarding the above information, please call the factory in Goleta, California, (805) 968-3551, and ask for Customer Service.



JOSLYN

ELECTRONIC SYSTEMS

1000 SERIES

DC PROTECTORS

RESPONSE TIME $<1\mu\text{s}$

DC PROTECTORS



DESCRIPTION

The Joslyn 1000 Series DC Protectors are designed to positively protect delicate DC-powered equipment from transients and large overvoltages. Joslyn protector design techniques efficiently combine fast response, very low clamping level, and the ability to bypass large amounts of transient energy repeatedly and consistently.

The protectors are designed for the suppression of transients produced by inductive or capacitive switching, including the switching of motors, air-conditioning equipment, fluorescent lighting, arc-welding equipment, and induced voltages in power cables induced from near-by lightning. Where protection from direct lightning or EMP is required, please consult the factory.

EXCLUSIVE FEATURES

ULTRAFAST PRECISION RESPONSE

A protector must be capable of clamping a voltage transient within a few microseconds, which is how little time there is, between the semiconductor reverse (blocking) voltage and the transient voltage at which the semiconductor will break down or be totally destroyed. Joslyn DC Protectors operate **within a fraction of one microsecond**. Clamping levels are generally set 50% above the peak operating steady-state voltage.

LONG LIFE

Quality workmanship and specialized engineering know-how are combined with design innovations to assure this unmatched longevity in Joslyn DC Protectors.

LINE INSERTION LOSS

Negligible as the device is passive and contains no moving parts. Normal applications are line-to-line. Line-to-ground protection may be provided as a special design feature.

DIRECT LIGHTNING STROKE CAPACITY

DC protectors are available with options that will take direct lightning strokes as specified in Mil-A-9094D. Additional options are protectors that provide EMP (Electro-Magnetic Pulse) protection per AF BSD 62-83. Consult factory.

EXCLUSIVE FEATURES

(Continued)

OPERATION

The protector effectively absorbs damaging transients, or bypasses them to ground, depending upon type of unit used.

The protector automatically interrupts any "follow current" that may occur as a result of its operation, and restores itself to normal operation.

MAINTENANCE

No inspection or maintenance is required.

VENT-FREE CONSTRUCTION

The protector discharge device is hermetically sealed. All gases and other arcing phenomena are contained within the sealed enclosure. Virtually noise-free.

OPERATING TEMPERATURE RANGE

Joslyn DC Protectors may be operated in the ambient temperature range of -20°F to $+130^{\circ}\text{F}$.

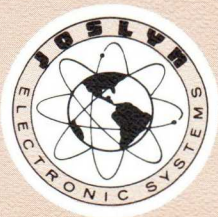

CONVENTIONAL METHODS OF PROTECTION—LIMITATIONS

There are several methods to protect transistorized DC equipment from damaging transients which may appear at the input:

1. Filter networks;
2. Fast-blow fuses or circuit breakers of various kinds;
3. Current-limiting resistors in series, or tungsten filament lamps across the load;
4. Selenium diodes or silicon zener diodes, back to back if placed on the AC side of the supply; or singly, if used on the DC side.

All these protective methods have several points in common: they are cheap, need repeated replacement, and do not guarantee protection against all types of transients. Filters are ideal where the transients have a precise ringing frequency and have small energy content. Fuses and circuit breakers lack speed of operation; and diodes lack the thermal capacity to bypass transients greater than their ratings, which are minimal at best. Current limiting resistors, though helpful, have the disadvantage of a large voltage drop in series with the load.

Selenium diodes and silicon zener diodes have the limitation of transient energy handling capabilities. These devices are hardly capable of handling a small portion of the energy that can be controlled by a low energy Joslyn spark gap. This gap is the first stage element in the Joslyn DC Protector.

APPLICATIONS

Joslyn 1000 Series DC Protectors are finding wide application in:

- Public utilities, telephone and railroad communications and control systems.
- Power supply equipment that may be damaged from induced voltage caused by nearby lightning discharges.
- Microwave systems.
- Complex weapons systems command and control circuits where downtime due to transients cannot be tolerated.

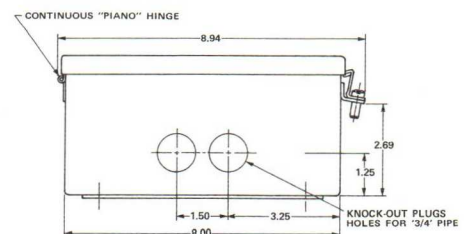
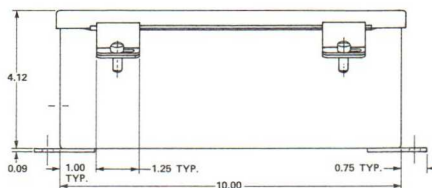
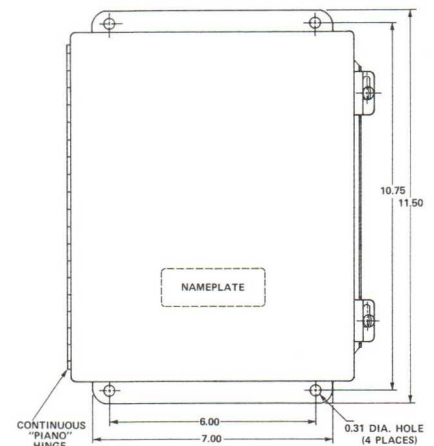

TYPICAL OSCILLOGRAPHIC RECORDS OF PROTECTOR PERFORMANCE

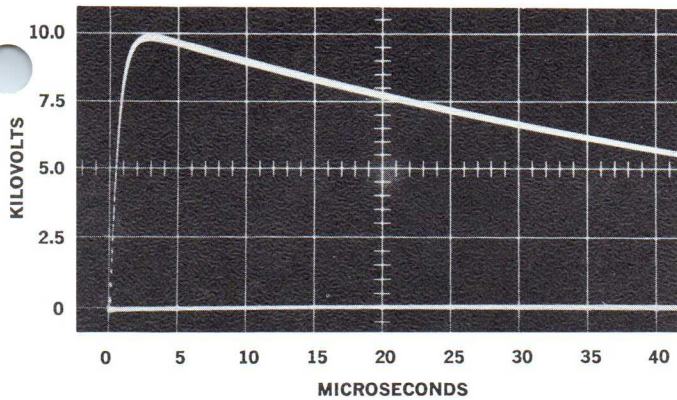

FIG. 1A shows a fast transient (at 10 kv/microsecond rate of rise) applied to the input terminals of the Joslyn 1016-01 Protector.

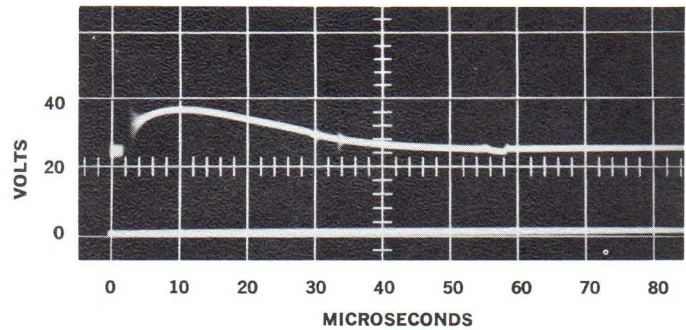

FIG. 1B shows the remnants of this transient appearing at the output terminals. It is seen how effectively the protector operates—reducing a 10,000-volt surge to less than 40 volts.

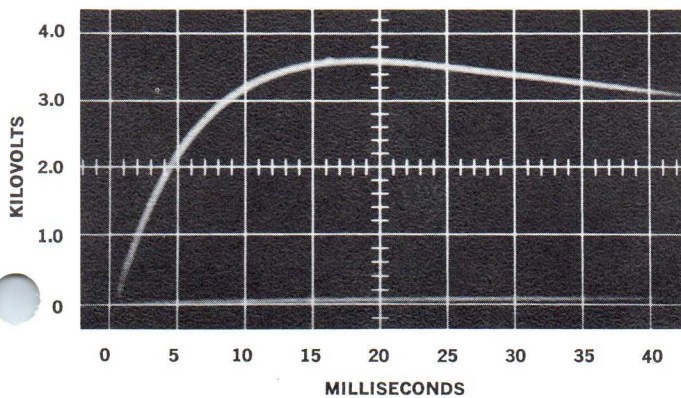

FIG. 2A shows a slow transient (at 500 v/millisecond rate of rise) applied to the input terminals of the Joslyn 1016-01 Protector.

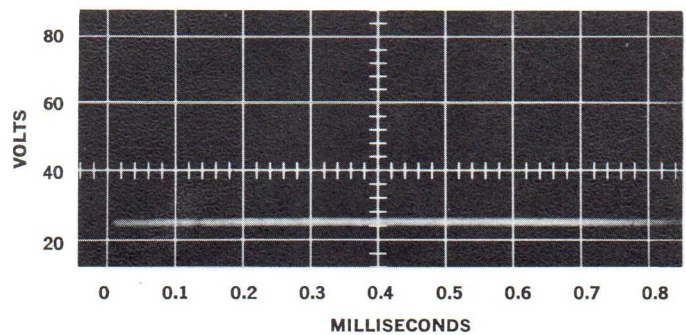

FIG. 2B shows only the operating DC voltage—the transient was completely eliminated.

The above oscillograms depict performance on very fast transients as well as on very slow transients. Whatever may be the nature of the transient, Joslyn's 1000 Series Protectors effectively and

expeditiously clamp transients to negligible value. The 1000 Series Protectors bypass very heavy transient energies, have unlimited life, and have no detectable deterioration in operating performance.

TECHNICAL SPECIFICATIONS

JOSLYN MODEL NUMBER	NOMINAL INPUT DC VOLT [†]	MAXIMUM LOAD CURRENT	VOLTAGE DROP AT 20 AMP	MAXIMUM SURGE CURRENT	CLAMPING VOLTAGE	MAXIMUM SIZE H-W-L
1013*	130V	20 amp	1.5V	5,000 amp	160-530V	4.21" x 8.94" x 11.50"
1014*	72V	20 amp	1.5V	5,000 amp	95-105V	4.21" x 8.94" x 11.50"
1015*	48V	20 amp	1.5V	5,000 amp	70-80V	4.21" x 8.94" x 11.50"
1016*	28V	20 amp	1.5V	5,000 amp	45-50V	4.21" x 8.94" x 11.50"
1017*	12V	20 amp	1.5V	5,000 amp	15-22V	4.21" x 8.94" x 11.50"

* -01: Neg. Ground
-02: Pos. Ground
-03: Floating

† Other voltages available—consult factory.

DEFINITIONS

LIGHTNING AND ELECTRICAL SURGE PROTECTOR

A protective device for limiting surge voltages on equipment by discharging or bypassing surge current. It prevents continued flow of "follow current", and is capable of repeating these functions.

SURGE

A surge in an electrical circuit is a transient wave of current, potential, or power.

WAVESHAPE DEFINITION OF A SURGE

The waveshape of a surge of current or voltage is designated by a combination of two numbers. The first number is an index of the wavefront expressed in microseconds from zero to the peak of the wave. The second number is an index of the wavetail also expressed in microseconds from zero to the instant that the wavetail reaches one-half of the crest or peak value. Example: 10 x 20 microsecond wave.

IMPULSE SPARKOVER VOLTAGE

The impulse sparkover voltage of a protector (arrester) is the highest value of voltage attained by an impulse of a designated waveshape and polarity applied across its terminals prior to the flow of discharge current.

DISCHARGE CURRENT

The discharge current of a protector (arrester) is the surge current which flows through the protector when sparkover occurs.

DISCHARGE VOLTAGE

The discharge voltage of a protector (arrester) is the voltage that appears across its terminals during passage of discharge current.

FOLLOW (POWER) CURRENT

The follow current of a protector (arrester) is the current from the connected power source which flows through the protector during and following the passage of discharge current.

EMP (ELECTRO-MAGNETIC PULSE)

EMP, a phenomenon caused by a nuclear detonation, and capable of producing large voltage and current transients in exposed and buried conductors.

To eliminate the problems caused by transients and surges on new equipment, as well as equipment already in use, the installation of Joslyn Protectors is mandatory. By using these protectors now, many months of trial-and-error testing will be eliminated and operating costs appropriately reduced. Make Joslyn protection a part of your maintenance programs.

FOR ASSISTANCE

For specific application information refer to the Joslyn Engineering Application Worksheet or contact the factory.

JOSLYN QUALITY CONTROL POLICY

Quality control procedures in force at Joslyn Electronic Systems meet the rigorous requirements of Mil-Q-9858A and Boeing D1-8000A.

JOSLYN
ELECTRONIC SYSTEMS

Division of Joslyn Mfg. and Supply Co.
SANTA BARBARA RESEARCH PARK
P.O. BOX 817
GOLETA, CALIFORNIA 93017
TELEPHONE: (805) 968-3551



**ELECTRONIC
SURGE
PROTECTION
EQUIPMENT**

THE FAST CLAMP-DOWN ON TRANSIENTS IN A RADAR MODULATOR

JOSLYN ELECTRONIC SYSTEMS

Division of Joslyn Mfg. and Supply Co.

6868 Cortona Drive, Santa Barbara Research Park
P. O. Box 817, Goleta, California 93017
Telephone: (805) 968-3551

Systems Protection in a Nuclear and Space Age Environment

THE FAST CLAMP-DOWN ON TRANSIENTS IN A RADAR MODULATOR

A typical Radar Modulator circuit might simply be described as follows. A pulse transformer supplies a repetitive series of pulses which by their characteristics cause the magnetron to oscillate at its given frequency and power output. The duration of each pulse determines the length of time the magnetron oscillates and the repetitive rate of the pulses determines how frequently it oscillates. The pulse transformer also supplies all the power required by the magnetron during its operating periods.

The pulse transformer used in the above manner may be required to supply pulses of varying durations, rise times, and repetition rates in a single modulator circuit. Operating characteristics for two of these conditions could be:

	Condition I	Condition II
Pulse width in microseconds	4.0	0.4
Pulses per second	200	2000
Rate of rise in volts per microsecond	300,000	200,000
Average Power in Watts	40	40

In Condition I, the magnetron starts oscillating when the pulse amplitude reaches approximately 15,000 volts. It oscillates for 4.0 microseconds, stops oscillating at the end of the pulse and then awaits the next pulse. It does this 200 times per second. The peak pulse power is in the order of 50,000 watts during each of these periods of oscillation. Condition II would be similar but with the appropriate parameters applied.

Should the magnetron fail to fire (start oscillating) a destructive condition would exist in the circuit. The transformer output pulse retains a leading edge configuration similar to a normal pulse but the voltage rises to 60,000 volts or more. The pulse decays at a slower than normal rate taking as long as three pulse widths to fall to 50% of the voltage reached. This phenomenon occurs at each pulse time and continues until the magnetron fires.

What then must a protective device do? It must in no way interfere with nor downgrade the normal performance of the circuit. It must recognize a fault condition and react rapidly enough to protect the circuit and components from damage that could be caused by the high energy levels present during a fault condition. It must restore the circuit to normal rapidly enough that each succeeding pulse has an opportunity to fire the magnetron. It must always operate and must continue to do so until the fault is corrected. A Joslyn Precision Spark Gap accomplishes all these things simply and at low cost.

Let's be more specific and apply the operating characteristics previously given to determine the parameters within which the Joslyn Precision Spark Gap must function. It was stated that the magnetron normally fires at 15,000 volts. The magnetron, however, is not considered to have misfired until the pulse amplitude has reached 19,000 volts. To prevent interference with the circuit and to allow a small margin for error, the spark gap must not fire until the pulse amplitude reaches 20,000 volts. If a 50% overvoltage condition is considered safe, the spark gap must fire before the pulse amplitude reaches 30,000 volts.

Under Condition I with a rate-of-rise of 300,000 volts per microsecond, the spark gap must therefore recognize a fault condition, magnetron misfire, and itself fire in less than 33 nanoseconds if the transformer output voltage is to be clamped at 30,000 volts. Extensive production testing indicates spark gap firing usually occurs within 15 nanoseconds of fault recognition and always within 25 nanoseconds. It might be noted here that there is no correlation between the commonly specified DC firing voltage of a spark gap and its firing voltage under the conditions specified.

Once the spark gap has fired (started to conduct) it represents a relatively low impedance load to the pulse transformer. Current surges can be well in excess of 4,000 amperes so the spark gap must be capable of carrying these surges without damage. The spark gap must then stop conducting (de-ionize) before the next pulse occurs and be capable of repeating this cycle continuously for periods of over thirty minutes. Under Condition I with 200 pulses per second, this may not appear severe. Under Condition II of 2,000 pulses per second, the time between pulses is short, less than 500 microseconds, and the number of pulses handled is high, 3,600,000 in thirty minutes. Under this kind of abuse, the Joslyn Precision Spark Gap has operated with a dull red glow and still continued to protect the circuit and components as specified.

The particular spark gap discussed is physically quite small, 2.6 inches long by 0.75 inches diameter, rugged enough to meet typical MIL environmental specifications, is hermetically sealed, is insensitive to light or dark, and uses no isotope prompting with its possible radiation hazard. These basic features are standard in all Joslyn Precision Spark Gaps.

The application presented may not typify your problems, but perhaps it gives an insight into the work being done at Joslyn Electronic Systems. If your requirement is for a protector with fast speed of response coupled with high energy handling capabilities to operate under a wide range of environmental conditions, Joslyn can assist you. Contact us and our know-how is at your disposal.

TYPICAL SPECIFICATIONS

IMPULSE		SPARKOVER		VOLTAGE		MAXIMUM INTERELECTRODE CAPACITANCE	MINIMUM SURGE CURRENT CAPABILITY	MINIMUM INSULATION RESISTANCE
300 KV / usec		200 KV / usec						
minimum	maximum	minimum	maximum					
20,000 V	30,000 V	20,000 V	30,000 V			2.0 pf	4000 A	1000 M Ω

MINIMUM LIFE UNDER CONTINUOUS FAULT CONDITION		MINIMUM STORAGE LIFE	MAXIMUM	ALTITUDE
0.4 usec pulse width 2000 p.p.s.	4.0 usec pulse width 200 p.p.s.		Operating	Storage
30 minutes	30 minutes	1 year	10,000 ft.	50,000 ft.

AMBIENT		TEMPERATURE		MAXIMUM	DIMENSIONS
OPERATING		STORAGE			
minimum	maximum	minimum	maximum	Diameter	Length
-55°C	+125°C	-65°C	+150°C	.750 in.	2.60 in.

- Fig. 1 A simple block diagram showing the location of the Joslyn Precision Spark Gap in the magnetron circuit. It is usually physically positioned as close to the pulse transformer as is practicable.
- Fig. 2 A graphic representation of the normal magnetron driving pulses described in the preceding text. The shorter pulse has the faster repetition rate so that average power for either pulse train is essentially the same.
- Fig. 3 A graphic representation, taken from photographs, showing a fault occurrence under the parameters described under Condition I. The energy levels present in the circuit under a typical fault condition can readily be compared to those normally present as well as those encountered with Joslyn Precision Spark Gap protection. By clamping the voltage at approximately 25,000 volts any sparkover due to excessive voltage is prevented, as is other possible damage to the circuit. The rapid deionization of the spark gap indicates that it is ready to properly protect the circuit at the next pulse time.
- Fig. 4 A graphic representation of a fault occurrence under the parameters described under Condition II. Again the energy levels present under the three possible situations can be compared. It is evident that under this short pulse condition, the energy dissipated by the Joslyn Precision Spark Gap is close to that normally dissipated by the magnetron. The spark gap is in essence replacing the magnetron in the circuit, and it is under this condition that the spark gap does indeed glow red. Even with this short pulse duration the spark gap has returned the circuit to its normal off condition well in advance of the next pulse time, in fact even faster than if the magnetron had fired normally.

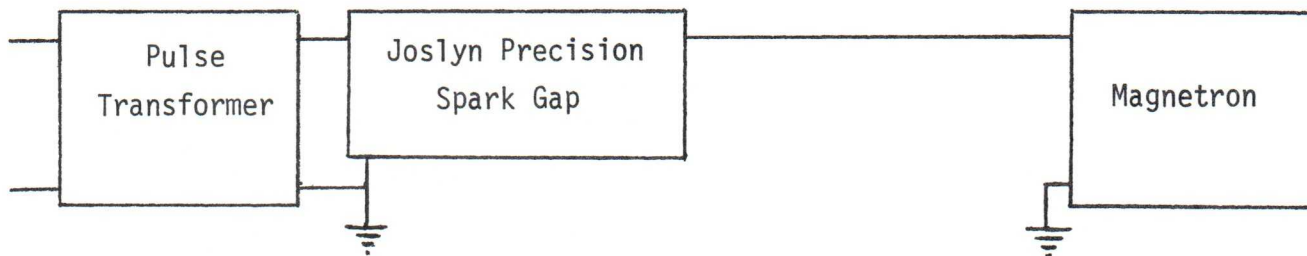
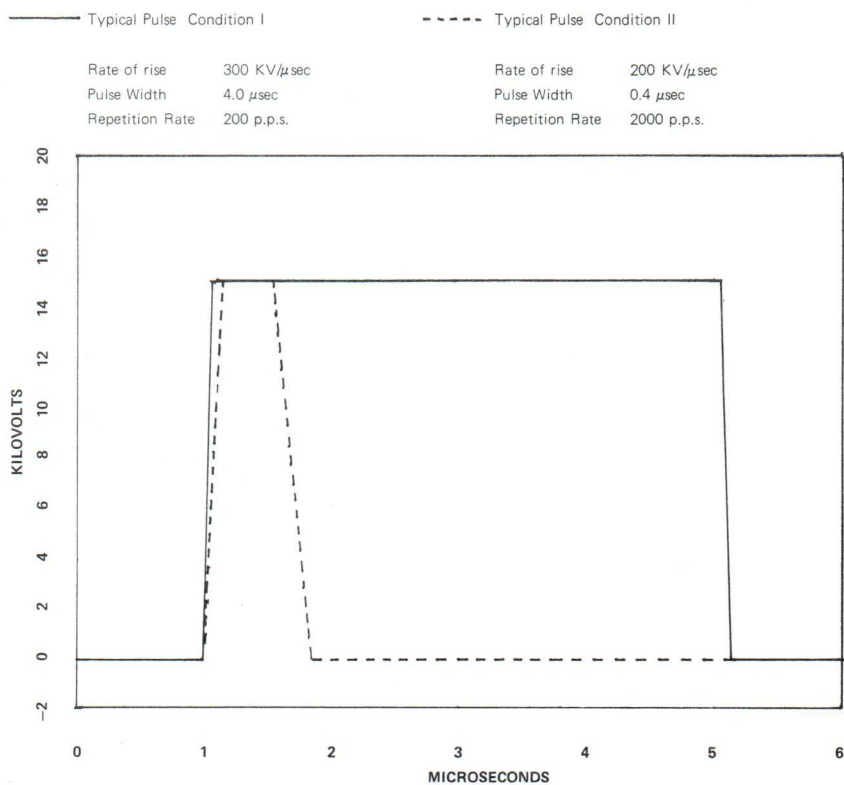

Figure 1 SIMPLIFIED BLOCK DIAGRAM

Figure 2 GRAPHIC REPRESENTATION



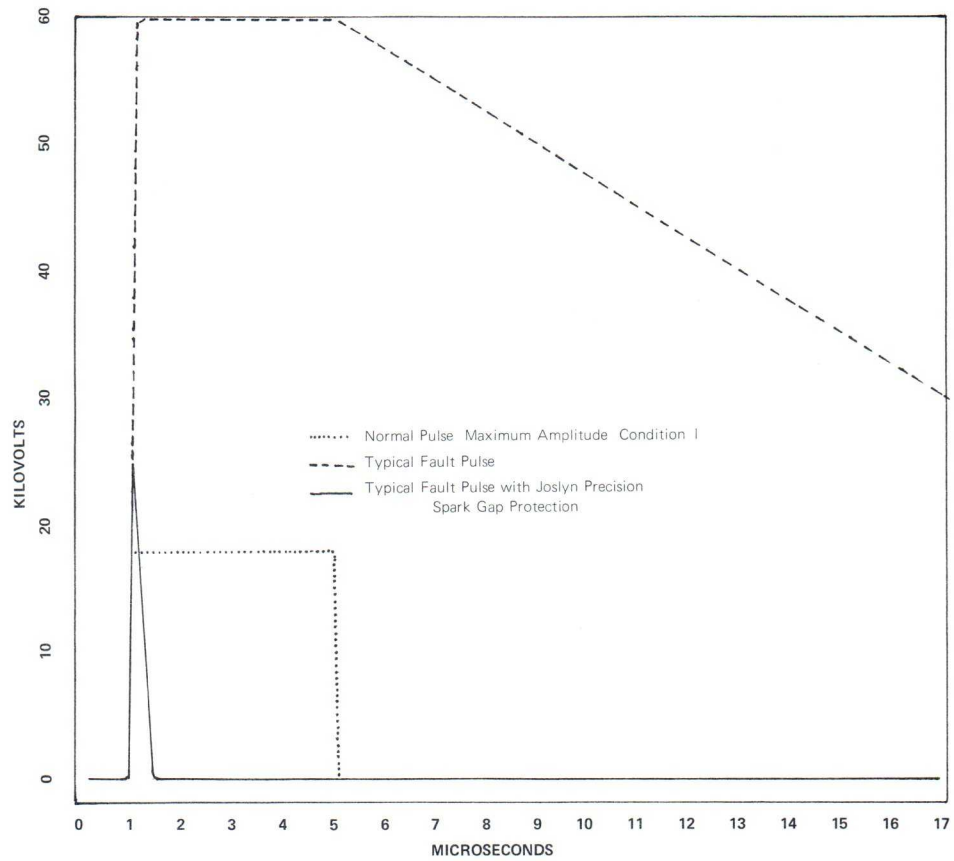

Figure 3

GRAPHIC REPRESENTATION

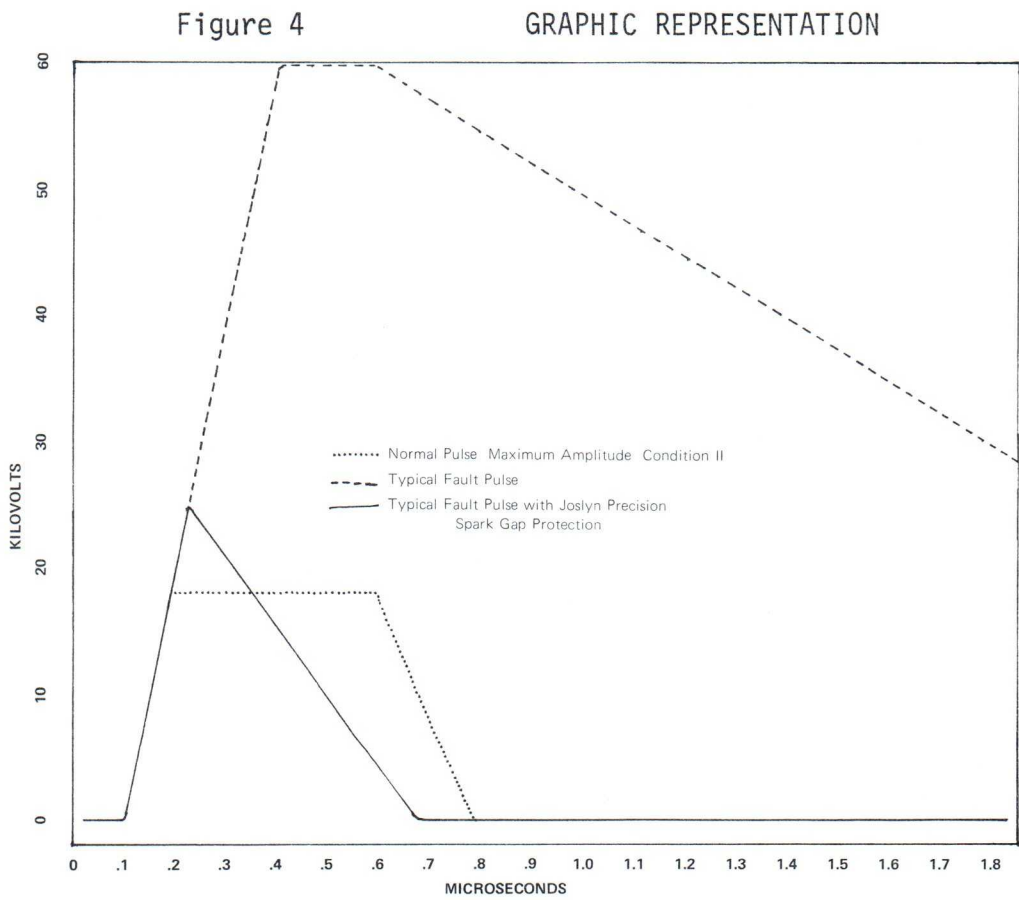

Figure 4

GRAPHIC REPRESENTATION

ELECTRONIC PROTECTION PRODUCTS FOR

AC Power Lines 1ϕ , 3ϕ , 60 Hz, 400 Hz

DC Power Lines 12 to 130 VDC

Signal, Telemetry, Carrier, Communication
and Video Transmission Lines

Transmitting and Receiving Antenna Systems

Industrial Protectors of all Types and Sizes

Airborne or Ground

REVISIONS			
LTR.	DESCRIPTION	DATE	APPROVED

HIGH ALUMINA CERAMIC BODY

HIGH TEMPERATURE BRAZE

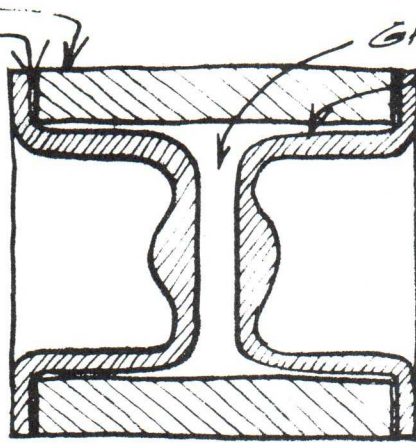

GAS FILLED

TEMPERATURE MATCHED ELECTRODES

NOTE:

LEADS OPTIONAL —

- SOLID OR STRANDED COPPER
- TIN, NICKLE OR GOLD PLATED.
- INSULATED

FEATURES OF JOSLYN MSP®

MINIATURE SURGE PROTECTOR

- HIGH ALUMINA CERAMIC BODY PROVIDES MECHANICAL STRENGTH AND INSENSITIVITY TO LIGHT ASSURING LONG LIFE AND PERFORMANCE STABILITY FOR YOU - EVEN THROUGH EXTREME SHOCKS AND VIBRATIONS
- TEMPERATURE MATCHED ELECTRODES FOR THERMAL COMPATABILITY WITH THE CERAMIC BODY, PLATED AS REQUIRED TO ASSURE LONG LIFE AND DESIRED BREAKDOWN CHARACTERISTICS FOR YOUR APPLICATION
- HIGH TEMPERATURE BRAZE FOR MAXIMUM MECHANICAL STRENGTH AND SEAL INTEGRITY OVER WIDE THERMAL CHANGES.
- GAS FILLED, WITH MIXTURE AND PRESSURE SELECTED TO PROVIDE SPECIFIED PERFORMANCE CHARACTERISTICS.
- CLIP OR PIGTAIL INSTALLATION CAN BE SOLDER MOUNTED DIRECTLY TO YOUR CIRCUIT BOARD.

UNLESS OTHERWISE SPECIFIED DIMENSIONS ARE IN INCHES TOLERANCES ON FRACTIONS ± DECIMALS ± ANGLES ±	DRAWN	 JOSLYN ELECTRONIC SYSTEMS SANTA BARBARA RESEARCH PARK — GOLETA, CALIF. DIVISION OF JOSLYN MFG. AND SUPPLY CO.		
	CHECKED			
DO NOT SCALE THIS DRAWING	ENGINEER			
MATERIAL	EFFECTIVE			
HEAT TREATMENT	APPROVED	CODE IDENT. NO.	SIZE A	DWG. NO.
FINISH	APPROVED	SCALE	WEIGHT	SHEET

