

\$1.90

# technical manual

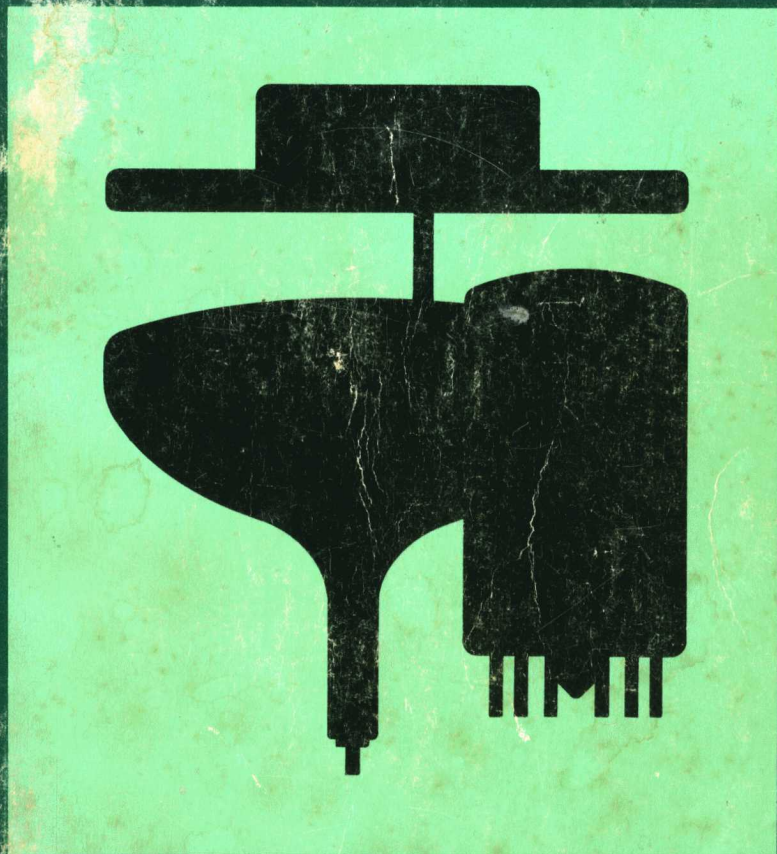

Receiving Tubes • Picture Tubes • ECG Semiconductors

# SYLVANIA

# SYLVANIA TECHNICAL MANUAL

FOURTEENTH EDITION

FIRST PRINTING

1970

SYLVANIA ELECTRONIC COMPONENTS

WALTHAM, MASS. 02154

*The information contained herein is believed to be accurate. However, no responsibility is assumed by Sylvania for its use nor for any infringements of patents or other rights of third parties which may result from its use. Reproduction, without express permission, of editorial or pictorial content, in any manner, is prohibited.*

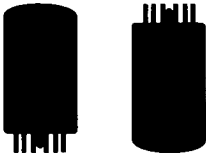
**RECEIVING  
TUBES****TECHNICAL DATA**

17

**REPLACEMENT GUIDES**

489

**DOUBLE/BRAND**

490

**FOREIGN-AMERICAN**

492

**INDUSTRIAL**

500

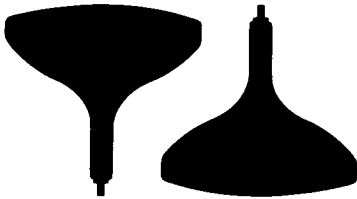
**TV PICTURE  
TUBES****TECHNICAL DATA**

503

**COLOR**

504

**MONOCHROME**

508

**REPLACEMENT GUIDES**

537

**COLOR**

538

**MONOCHROME**

539

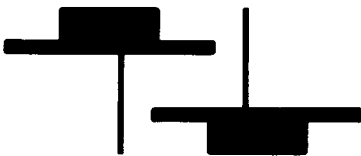
**ECG REPLACEMENT  
SEMICONDUCTORS****TECHNICAL DATA**

547

**REPLACEMENT GUIDES**

557

**TRANSISTORS**

558

**DIODES/RECTIFIERS**

599

**COLOR OSC CRYSTALS**

622

## Introduction

The 14th Edition Sylvania Technical Manual is completely revised and updated. A replacement guide for Semiconductors has been added, as well as technical data on the latest receiving and television picture tubes. The semiconductor guide provides replacement information for more than 28,000 types.

Industry—wide in scope, the manual is prepared primarily for the service technician engaged in the trouble-shooting and repair of home entertainment equipment. The engineer, industrial technician, student of electronics and home experimenter will also find it a valuable addition to their technical library.

# MASTER INDEX

Type	Page	Type	Page	Type	Page	Type	Page
OA2	434	1DN5	435	2BU2/ZAS2A	27	3AU6	72
GB-OA2WA	434	1DY4A	435	2C21	436	3AV6	75
OA3	434	1G3GT	23	2C22	436	3AW2A	29
OA3A	434	1G3GT/1B3GT	23	2C50	436	3AW3	437
OA4G	434	1H2	435	2C51	436	3B2	437
OA5	434	1H5GT	435	2C52	436	3B7	437
OB2	434	1J3	435	2CN3B	34	3BA6	83
GB-OB2WA	434	1J3A	435	2CW4	149	3BC5	437
OB3	434	1K3	23	2CY5	152	3BC5/3CE5	437
OB3A	434	1K3/1J3	23	2D21	436	3BE6	91
OC2	434	1L4	435	2DF4	437	3BF2	437
OC3	434	1L6	435	2DS4	166	3BL2A	30
OC3A	434	1LA4	435	2DV4	169	3BM2A	31
OD3	434	1LA6	435	2DX4	437	3BN2A	32
OD3A	434	1LB4	435	2DY4	437	3BN4A	106
OY4	434	1LC5	435	2DZ4	172	3BN6	107
OY4G	434	1LC6	435	2DZ4/2AF4B	172	3BS2A	32
OZ4	19	1LD5	435	2E26	437	3BU8	223
OZ4A	19	1LE3	435	2EA5	437	3BX6	437
OZ4G	19	1LG5	435	2EG4	437	3BY6	120
1A3	434	1LH4	435	2EN5	437	3BY7	437
1A5GT	434	1LN5	436	2EP4	508	3BZ6	124
1A7GT	434	1N2A	436	2ER5	185	3CA3	33
1AC5	434	1N5GT	436	2ES5	186	3CB6	131
1AD2	19	1R4	436	2EV5	190	3CB6/3CF6	131
1AD5	434	1R5	436	2FH5	196	3CE5	437
1AE4	434	1RK41	435	2FQ5A	215	3CF6	437
1AF4	434	1S2A	436	2FS5	202	3CF6/3CB6	437
1AF5	434	1S2A/DY87	436	2FY5	204	3CN3A	34
1AG4	434	1S4	436	2FV6	202	3CS6	145
1AG5	434	1S5	436	2GK5	215	3CU3A	34
1AH4	434	1S6	436	2GK5/2FQ5A	215	3CV3	437
1AJ2	434	1T4	436	2GU5	225	3CX3	437
1AJ5	434	1U4	436	2GW5	437	3CZ3	437
1AK4	435	1U5	436	2HA5	234	3CY5	152
1AK5	435	1U6	436	2HK5	248	3D6	437
1AN5	435	1V2	24	2HM5	234	3DA3	437
1AU2	435	1V6	436	2HQ5	250	3DB6	437
1AU3	435	1X2B	25	2HR8	437	3DC3	35
1AX2	435	2A3	436	2T4	346	3DG4	36
1AY2	20	2AF4B	172	2X2	437	3DHH13	437
1B3GT	23	2AH2	25	2X2A	437	3DK6	160
1BC2	20	2AS2A	27	3A2	27	3DT6	438
1BH2	21	2AV2	26	3A3B	28	3DT6A	168
1BK2	435	2AZ2	436	3A4	437	3DX4	438
1BK2/1RK41	435	2B3	436	3A5	437	3DY4A	438
1BL2	435	2BA2	436	3AF4A	437	3DZ4	172
1BV2	435	2BJ2	436	3AF4B	437	3DZ4/3AF4B	172
1BY2	22	2BN4A	106	3AL5	57	3EA5	438
1DK29	435	2BU2	27	3AT2A	29	3EH7	179

Type	Page	Type	Page	Type	Page	Type	Page
3EH7/XF183	179	4CX7	438	5AW4	439	5T8	347
3EJ7	181	4CY5	152	5AX4GT	439	5TP4	508
3EJ7/XF184	181	4DE6	157	5AXP4	532	5U4G	440
3ER5	185	4DK6	160	5AZ3	439	5U4GA	440
3ES5	186	4DT6	438	5AZ4	439	5U4GB	42
3EV5	190	4DT6A	168	5B8	439	5U4WG	440
3FH5	196	4EH7	179	5BC3	40	5U8	349
3FQ5A	215	4EJ7	181	5BC3A	41	5U9	350
3FS5	202	4ES8	186	5BE8	439	5U9/LCF201	350
3FW7	438	4EW6	190	5BK7A	102	5V3	440
3FX7	438	4GJ7	214	5BQ7A	112	5V3A	43
3FX7/3DHH13	438	4GK5	215	5BR8	114	5V4GA	44
3FY5	204	4GM6	220	5BS8	116	5V6GT	354
3GK5	215	4GS7	438	5BT8	117	5X8	359
3GS8	223	4GS8	223	5BW8	439	5X9	360
3GS8/3BU8	223	4GS8/4BU8	223	5BZ7	112	5Y3GT	45
3GU5	225	4GW5	438	5CG4	439	5Y3GA	440
3GW5	438	4GX7	230	5CG8	135	GB-5Y3WGTA	440
3HA5	234	4GZ5	233	5CL8A	139	5Y4GA	46
3HA5/3HM5	234	4HA5	234	5CM6	140	5Y4GT	440
3HK5	248	4HA5/PC900	234	5CM8	142	5Z3	440
3HM5	234	4HA7	438	5CQ8	144	5Z4GT	440
3HM6	250	4HA7/4HC7	438	5CR8	439	6A3	440
3HQ5	250	4HC7	438	5CU4	439	6A7	440
3HS8	255	4HG8	245	5CZ5	154	6A8GT	440
3HT6	257	4HK5	248	5DH8	439	6AB4	46
3JC6	267	4HM5	234	5DJ4	41	6AB7	440
3JC6A	268	4HM6	250	5EA8	175	6AB8	440
3JD6	270	4HQ5	250	5EH8	439	6AB8/ECL80	440
3KF8	438	4HR8	438	5ES8	186	6AB9	440
3KT6	438	4HS8	255	5EU8	189	6AC7	440
3LF4	438	4HT6	257	5EW6	190	6AC9	47
3MP26	438	4JC6	267	5FG7	195	6AC10	48
3Q4	438	4JC6A	268	5FV8	203	6AD4	440
3Q5GT	438	4JD6	270	5GH8	175	6AD6G	440
3S4	438	4JH6	275	5GH8A	175	6AD10	49
3V4	438	4JK6	276	5GJ7	214	6AF3	50
3Z4	438	4JL6	278	5GM6	220	6AF4A	172
4AU6	72	4KE8	299	5GS7	439	6AF6G	440
4AV6	75	4KF8	439	5GX6	232	6AF10	440
4BA6	83	4KN8	439	5GX7	230	6AF11	51
4BC5	438	4KT6	439	5HA7	439	6AG5	440
4BC8	88	4LJ8	324	5HB7	237	6AG7	440
4BE6	91	4MK8	338	5HC7	439	6AG9	52
4BL8	104	4MP12	439	5HG8	245	6AG10	440
4BL8/XCF80	104	4MP26	439	5HG8/LCF86	245	6AG11	53
4BN4	438	4RRH8	439	5HZ6	259	6AH4GT	440
4BN6	107	4RRH8/4KN8	439	5J6	261	6AH6	54
4BQ7A	112	5AF4A	439	5JK6	276	6AH9	55
4BQ7A/4BZ7	112	5AM8	59	5JL6	278	6AJ4	440
4BS8	116	5AN8	62	5KD8	349	6AJ5	440
4BU8	223	5AQ5	63	5KE8	299	6AK4	440
4BX8	438	5AR4	37	5KZ8	313	6AK5	56
4BZ6	124	5AR4/GZ34	37	5LJ8	324	6AK5/EF95	56
4BZ7	112	5AS4A	38	5MB8	333	6AK6	441
4BZ8	125	5AS8	67	5MK9	439	6AK8	441
4CB6	131	5AT4	439	5MQ8	439	6AK8/EABC80	441
4CE5	438	5AT8	70	5R4GYB	439	6AK9	441
4CM4	438	5AU4	38	5RK16	439	6AK10	56
4CS6	145	5AV8	39	5T4	439	6AL3	57

Type	Page	Type	Page	Type	Page	Type	Page
6AL3/EY88	57	6BC8	88	6BW3	411	6CR8	443
6AL5	57	6BD4A	441	6BW4	442	6CS6	145
6AL7GT	441	6BD5GT	441	6BW8	442	6CS7	146
6AL9	58	6BD6	89	6BW11	119	6CS8	443
6AL11	441	6BD11	89	6BX6	442	6CT3	147
6AM4	441	6BE3A	91	6BX6/EF80	442	6CU5	148
6AM8A	59	6BE6	91	6BX7GT	442	6CU6	111
6AN4	60	6BE8A	441	6BX8	442	6CU8	148
6AN5	61	6BF5	441	6BY5GA	442	6CW4	149
6AN6	441	6BF6	442	6BY6	120	6CW5	150
6AN8A	62	6BF7W	442	6BY8	121	6CW5/EL86	150
6AQ5A	63	6BF8	442	6BY11	122	6CX7	443
6AQ6	64	6BF11	92	6BZ3	123	6CX8	151
6AQ7GT	441	6BG6GA	442	6BZ6	124	6CY5	152
6AQ8	65	6BH3	94	6BZ7	112	GB-6CY5	443
6AQ8/ECC85	65	6BH3A	94	6BZ8	125	6CY7	153
6AR5	441	6BH6	95	6C4	126	6CZ5	154
6AR11	65	6BH8	95	6C5GT	442	6D4	443
6AS5	66	6BH11	96	6C6	442	6D6	443
6AS6	441	6BJ3	97	6C8G	442	6D10	155
6AS7GYB	441	6BJ5	442	6C9	442	6DA4A	155
6AS8	67	6BJ6	98	6C10	127	6DA4A/6DM4A	155
6AS11	68	6BJ6A	98	6CA4	442	6DA7	443
6AT6	69	6BJ7	99	6CA5	442	6DB5	443
6AT8A	70	6BJ8	99	6CA7	127	6DB6	443
6AU4GTA	72	6BK4C	100	6CA7/EL34	127	6DC6	443
6AU5GT	441	6BK4C/6EL4A	100	6CA11	129	6DC8	443
6AU6A	72	6BK5	442	6CB5A	130	6DE4	156
GB-6AU6WB	441	6BK7B	102	6CB6A	131	6DE6	157
6AU8A	73	6BK11	442	6CD3	133	6DE7	157
6AV5GA	74	6BL4	442	6CD6GA	132	6DG6GT	443
6AV6	75	6BL7GTA	103	6CE3	133	6DG7	443
6AV11	76	6BL8	104	6CE3/6CD3	133	6DHH13	443
6AW8A	76	6BL8/ECF80	104	6CE5	441	6DJ8	158
6AX3	77	6BM8	105	6CF6	442	GB-6DJ8	443
6AX4GTB	78	6BM8/ECL82	105	6CG3	133	6DK6	160
6AX5GT	79	6BN4A	106	6CG7	134	6DL4	443
6AX7	384	6BN6	107	6CG7/6FQ7	134	6DL4/EC88	443
6AX8	441	6BN6/6KS6	107	6CGBA	135	6DM4A	155
6AY3	79	6BN8	108	6CH3	136	6DN6	443
6AY3A	80	6BN11	109	6CH7	443	6DN7	161
6AY3B	80	6BQ5	110	6CH8	443	6DQ4	162
6AY11	81	6BQ5/EL84	110	6CJ3	443	6DQ5	162
6AZ5	441	6BQ6GTB	111	6CK3	137	6DQ6B	163
6AZ8	81	6BQ6GTB/6CU6	111	6CK4	443	6DQ6B/6GW6	163
6B3	441	6BQ7A	112	6CL3	137	6DR4	443
6B4G	441	6BQ7A/6BZ7	112	6CL5	443	6DR7	164
6B8	441	GB-6BQ7A	442	6CL6	138	6DS4	166
6B10	82	6BR3	447	6CL8A	139	6DS5	444
6BA3	441	6BR8A	114	6CM3	140	6DT4	444
6BA5	441	6BS3	115	6CM4	443	6DT5	167
6BA6	83	6BS3A	116	6CM5	443	6DT6A	168
6BA6/EF93	83	6BS8	116	6CM6	140	6DT8	169
6BA7	441	6BT8	117	6CM7	141	6DV4	169
6BA8A	84	6BU4	442	6CM8	142	6DW4A	170
6BA11	85	6BU5	442	6CN7	143	6DW4B	171
6BC4	87	6BU8	223	6CQ4	443	6DW5	444
6BC5	441	6BU8A	442	6CQ8	144	6DX4	444
6BC5/6CE5	441	6BV8	442	6CR4	443	6DX8	171
6BC7	88	6BV11	118	6CR6	443	6DX8/ECL84	171

Type	Page	Type	Page	Type	Page	Type	Page
6DY4A	444	6FQ5A	215	6GY8	233	6JE6C/6LQ6	271
6DY5	444	6FQ7	134	6GZ5	233	6JE8	272
6DZ4	172	6FR7	445	6H6	445	6JF6	273
6DZ4/6AF4A	172	6FSS	202	6HG6T	445	6JG6	446
6DZ7	444	6FV6	202	6HA5	234	6JG6A	274
6DZ8	444	6FV8A	203	6HA5/6HM5	234	6JH6	275
6E5	444	6FW5	445	6HA6	445	6JH8	275
6EA4	173	6FW7	445	6HB5	235	6JK6	276
6EA5	444	6FW8	445	6HB6	236	6JK8	277
6EA7	174	6FX7	445	6HB7	237	6JL6	278
6EA8	175	6FX7/6DHH13	445	6HC8	445	6JL8	446
6EA8/6GH8A	175	6FY5	204	6HD5	445	6JQ6	446
6EB5	444	6FY7	205	6HD7	238	6JM6	279
6EB8	177	6G11	206	6HE5	239	6JM6A	280
6EF4	178	6GA7	445	6HE7	241	6JN6	281
6EH4	444	6GB5	207	6HF5	242	6JN6A	282
6EH5	178	6GB5/EL500	207	6HF8	243	6JN8	283
6EH7	179	6GC5	208	6HG5	244	6JR6	446
6EH7/EF183	179	6GC6	445	6HG8	245	6JS6C	284
6EH8	444	6GD7	445	6HG8/ECF86	245	6JT6	285
6EJ4	444	6GE5	208	6HJ5	246	6JT6A	286
6EJ7	181	6GE8	445	6HJ8	247	6JT8	287
6EJ7/EF184	181	6GF5	209	6HK5	248	6JU6	288
6EL4A	100	6GF7	210	6HL5	445	6JU8	446
6EL7	444	6GF7A	212	6HL8	249	6JUA8A	289
6EM5	182	6GH8A	175	6HM5	234	6JV8	289
6EM7	183	6GJ5	212	6HM6	250	6JW8	290
6EQ7	184	6GJ5A	214	6HQ5	250	6JW8/ECF802	290
6ER5	185	6GJ7	214	6HQ6	445	6JY8	446
6ES5	186	6GJ7/ECF801	214	6HR5	252	6JZ6	291
6ES8	186	6GJ8	445	6HR6	253	6JZ8	292
6ES8/ECC189	186	6GK5	215	6HS5	254	6KGGT	294
6ET7	187	6GK5/6FQ5A	215	6HS6	254	6K7	446
6EU7	188	6GK6	216	6HS8	255	6K8	446
6EU8	189	6GK7	445	6HT6	257	6K11	295
6EV5	190	6GL7	218	6HU6	445	6K11/6Q11	295
6EV7	444	6GM5	219	6HU6/EM87	445	6KA8	296
6EW6	190	6GM6	220	6HV5	446	6KD6	298
6EW7	191	6GM8	445	6HU8	258	6KD8	349
6EX6	444	6GN6	445	6HU8/ELL80	258	6KE6	446
6EY6	444	6GN8	221	6HW8	446	6KE8	299
6EZ5	192	6GQ7	222	6HZ6	259	6KF8	446
6EZ8	193	6GS7	445	6HZ8	260	6KL8	446
6F5	444	6GS8	223	6J4	446	6KM6	300
6F5GT	444	6GT5	224	GB-6J4WA	446	6KM8	302
6F6GT	444	6GT5A	225	6J5GT	446	6KN6	303
6FA7	444	6GU5	225	6J6A	261	6KN8	447
6FC7	444	6GU7	226	6J6WA	446	6KR8	304
6FD6	444	6GV5	226	6J7GT	446	6KR8A	305
6FD7	194	6GV7	445	6J9	262	6KS6	107
6FE5	445	6GV8	227	6J10	262	6KS8	306
6FG5	445	6GW5	445	6J11	264	6RHH8	447
6FG6	445	6GW6	163	6JA8	265	6KV6	446
6FG6/EM84	445	6GW8	229	6JB6	266	6KT8	307
6FG7	195	6GW8/ECL86	229	6JB6A	267	6KU8	309
6FH5	196	6GX6	232	6JC6	267	6KV6	446
6FH8	197	6GX7	230	6JC6A	268	6KV6A	310
6FJ7	198	6GY5	231	6JC8	269	6KV8	311
6FM7	199	6GY6	232	6JD6	270	6KY6	446
6FM8	200	6GY6/6GX6	232	6JE6C	271	6KY8	312



Type	Page	Type	Page	Type	Page	Type	Page
6KY8A	313	6SF7	447	7B8	449	8DP4	508
6KZ8	313	6SG7	447	7C5	449	8EB8	177
6L6GC	315	6SH7	447	7C6	449	8EM5	182
6L7	446	6SJ7GT	342	7C7	449	8ET7	187
6LB6	317	6SJ7WGT	447	7DJ8	158	8FQ7	134
6LB8	318	6SK7GT	343	7DP4	508	8GJ7	214
6LC6	319	6SL7GT	343	7ES8	449	8GJ7/PCF801	214
6LC8	320	GB6SJ7WGT	447	7EY6	449	8GN8	221
6LE8	321	GB6SL7WGT	448	7F7	449	8GU7	226
6LF6	322	6SN7GTB	344	7F8	449	8GX7	230
6LF8	328	GB-6SN7WGTA	448	GB-7FBW	449	8HG8	245
6LG6	447	6SQ7GT	345	7FC7	449	8JEB	272
6LG6A	447	6SR7	448	7G7	449	8JK8	277
6LJ6A	447	6SS7	448	7GS7	449	8JL8	450
6LJ6A/6LH6A	447	6T4	346	7GV7	449	8JT8	287
6LH6A	447	6T8A	347	7H7	449	8JU8A	289
6LJ8	324	6T9	448	7HG8	245	8JV8	289
6LM8	325	6T10	347	7HG8/PCF86	245	8KA8	296
6LN8	104	6U5	449	7J7	449	8KP4	508
6LP8	447	6U6GT	449	7K7	449	8KR8	304
6LQ6	447	6U8A	349	7KY6	449	8KS8	306
6LQ8	326	6U8A/6KD8	349	7KZ6	449	8LC8	320
6LR6	447	6U9	350	7L7	449	8LE8	321
6LR8	327	6U10	352	7MP18	449	8LS6	450
6LT8	328	6V3A	353	7NP	449	8LT8	328
6LU8	329	6V4	448	7Q7	450	8MU8	339
6LV6	447	6V4/EZ80	448	7R7	450	8SN7GTB	344
6LX8	330	6V6GTA	354	7RP4	508	8U9	350
6LX8/LCF802	330	6V8	448	7S7	450	8X9	360
6LY8	331	6W4GT	355	7V7	450	8XP4	532
6M11	332	6W4GTA	356	7W7	450	8YP4	532
6MB8	333	6W6GT	356	7X7	450	9A8	368
6MD8	334	6X4	357	7Y4	450	9A8/PCF80	368
6ME8	335	GB-6X4WA	448	7Z4	450	9ACP4	508
6MF8	336	6X5GT	358	8A8	368	9AH9	55
6MG8	337	6X5WGT	448	8AC9	47	9AK10	56
6MJ8	338	GB-6X5WGT	448	8AC10	48	9AQ8	65
6MK8	338	6X8A	359	8AL9	58	9AU7	382
6ML8	447	6X9	360	8AR11	65	9BJ11	450
6MN8	447	6X9/ECF200	360	8AUBA	73	9BR7	388
6MQ8	447	6Y6GA	361	8AW8A	76	9BR8	450
6MU8	339	6Y9	362	8B8	397	9CG8A	450
6N7GT	447	6Z4	448	8B10	82	9CL8	450
6Q7GT	447	6Z4/84	448	8BABA	84	9DZ8	450
6Q11	295	6Z10	363	8BA11	85	9EA8	175
6R7	447	7A4	448	8BH8	95	9EF6	450
6RA6	447	7A4/XXL	448	8BM11	364	9GH8A	175
6RAL1	447	7A5	448	8BN8	108	9GV8	227
6RHH8/6KN8	447	7A6	448	8BN11	109	9JW8	290
6RK19	447	7A7	448	8BQ5	110	9KC6	369
6RK19/6BR3	447	7A8	448	8BQ11	365	9KX6	370
6RP15	447	7AF7	448	8BU11	366	9KZ8	313
6RP22	447	7AG7	448	8CG7	134	9LA6	371
6SA4	340	7AK7	448	8CG7/BFQ7	134	9MHH3	450
6SA7	447	GB-7AK7	448	8CM7	141	9MN8	450
6SA7GT	341	7AU7	382	8CN7	143	9MP12	450
6SA7GTY	447	7B4	448	8CS7	146	9QP4	508
6SB7Y	447	7B5	449	8CW5A	150	9QPA	508
6SC7	447	7B6	449	8CX8	151	9RA6	450
6SF5	447	7B7	449	8CY7	153	9RAL1	450

Type	Page	Type	Page	Type	Page	Type	Page
9SP4	508	11BM8	397	12AU7A/ECC82	382	12BZ6	124
9TP4	508	11BP4	508	12AV5GA	74	12BZ7	389
9U8A	349	11BQ11	365	12AV6	75	12BZP4	510
9UP4	508	11BT11	451	12AV7	383	12C5	148
9VP4	508	11C5	418	12AW6	451	12C5/12CU5	148
9WP4	508	11CA11	129	12AX3	77	12C8	452
9YP4	508	11CF11	451	12AX4GTB	78	12CA5	452
9X8	359	11CP4	508	12AX7A	384	12CBP4	510
10ABP4	508	11CY7	153	12AX7A/ECC83	384	12CDP4	510
10ABP4A	508	11DP4	508	12AY3	79	12CEP4	510
10ABP4B	508	11DS5	451	12AY3A	80	12CFP4	510
10ABP4C	508	11EP4	508	12AY7	452	12CHP4	510
10ADP4	508	11FP4	508	12AYP4	508	12CK3	137
10AEP4	508	11FY7	205	12AZ7A	385	12CL3	137
10AF11	51	11GP4	508	12AZP4	508	12CM6	140
10AL11	451	11HM7	376	12B3	452	12CN5	452
10ARP4	508	11HP4	508	12BA4	452	12DCF22	504
10BP4	508	11HP4A	508	12BA6	83	12CNP4	510
10BP4A	508	11JE8	272	12BA7	452	12CNP4A	510
10BP4C	508	11JP4	508	12BAP4	508	12CQP4	510
10BP4D	508	11KP4	508	12BD6	89	12CR6	452
10BQ5	110	11KV8	311	12BE3A	91	12CS6	145
10C8	451	11LQ8	326	12BE6	91	12CSP4	510
10CW5	150	11LT8	328	12BEP4	508	12CT8	452
10CW5/LL86	150	11MP4	508	12BF6	452	12CTP4	510
10DA7	451	11MS8	451	12BF11	92	12CU5	148
10DE7	157	11QP4	508	12BFP4	508	12CU6	111
10DR7	164	11RP4	508	12BGP4	508	12CVP4	510
10DX8	171	11SP22	504	12BH7A	386	12CW4	510
10DX8/LCL84	171	11TP4	508	12BJ3	452	12CX6	452
10EB8	177	11UP4	508	12BJP4	508	12CY6	452
10EG7	372	11WP22	504	12BK5	452	12CZP4	510
10EM7	183	11Y9	362	12BKP4	508	12D4	452
10EW7	191	11Y9/LFL200	362	12BL6	387	12D4A	155
10FD7	194	12A6	451	12BLP4	508	12DB5	452
10FP4	508	12A8GT	451	12BMP4	508	12DCP22	504
10FP4A	508	12AB5	377	12BN6	107	12DE8	452
10FR7	451	12AC6	451	12BNP4	508	12DEP4	510
10GF7	210	12AD5	451	12BNP4A	508	12DF5	452
10GF7A	212	12AD6	378	12BQP4	508	12DF7	452
10GK6	216	12AD7	451	12BQ6GTB	111	12DHP4	510
10GN8	221	12AE6A	379	12BQ6GTB/12CU6	111	12DJ8	158
10HA6	451	12AE7	451	12BR3	455	12DK5	452
10HF8	243	12AE10	451	12BR7	388	12DK6	160
10JA8	265	12AF3	50	12BRP4	508	12DK7	452
10JT8	287	12AF6	380	12BS3	115	12DL8	452
10JY8	373	12AF11	51	12BS3A	116	12DM4A	452
10KR8	304	12AG6	451	12BSP4	508	12DM5	452
10KU8	309	12AJ6	451	12BT3	452	12DM7	453
10LB8	318	12AL5	57	12BTP4	508	12DMP4	532
10LE8	321	12AL8	451	12BUP4	508	12DQ4	162
10LY8	331	12AL11	451	12BUP4A	508	12DQ6B	163
10LW8	374	12AQ5	63	12BUP4B	510	12DQ6B/12GW6	163
10LZ8	375	12AS5	451	12BV7	452	12DQ7	453
10MP4	508	12AT6	69	12BV11	118	12DS7	453
10MP4A	508	12AT7	380	12BVP4	510	12DS7A	453
10RP4	508	12AT7WA	451	12BW4	452	12DT5	167
10Z10	363	12AT7/ECC81	380	12BX6	452	12DT6	453
11AP4	508	12AU6	72	12BY3	452	12DT7	453
11AR11	65	12AU7A	382	12BY7A	389	12DT8	169

Type	Page	Type	Page	Type	Page	Type	Page
12DU7	453	12JB6A	267	13GB5	207	15AF11	51
12DV7	453	12JN6	281	13GB5/XL500	207	15BD11	89
12DV8	453	12JN6A	282	13GF7	210	15BD11A	89
12DW4A	170	12JN8	283	13GF7A	212	15CW5	150
12DW5	453	12JQ6	454	13J10	262	15CW5/PL84	150
12DW7	453	12JS6	284	13JZ8	292	15DQ8	455
12DW8	453	12JT6	285	13J10/13Z10	262	15EA7	174
12DY8	453	12JT6A	286	13GP22	504	15EW6	190
12DZ6	453	12K5	454	13V10	455	15EW7	191
12DZ8	453	12K7GT	454	13Z10	262	15FM7	199
12EA6	453	12K8	454	14A7	455	15FY7	205
12EC8	453	12KL8	455	14ACP4	510	15GP22	504
12ED5	453	12KP4	510	14AEP4	510	15HA6	455
12EF6	453	12KPA4	510	14AF7	455	15HB6	236
12EG6	453	12L6GT	455	14AF7/XXD	455	15HP22	504
12EH5	178	12LP4	510	14AJPA	510	15JP4	512
12EK6	390	12LPA4A	510	14ARP4	510	15KP22	504
12EL6	453	12LP4C	510	14ASP4	510	15KY8	312
12EM6	453	12MD8	334	14ATPA	510	15KY8A	313
12EN6	453	12Q7GT	455	14AUP4	510	15LE8	321
12EQ7	184	12R5	455	14AVPA	510	15LP22	504
12EZ6	453	12RK19	455	14AWPA	510	15MF8	336
12F5GT	454	12RK19/12BR3	455	14B6	455	15MP22	504
12F8	391	12SA7GT	341	14BCP22	504	15NP22	504
12FA6	454	12SC7	455	14BP4	510	15RP22	504
12FB5	454	12SF5GT	455	14BP4A	510	15SP22	504
12FK6	454	12SF7	455	14BAP4	510	15WP22	504
12FM6	454	12SG7	455	14BDPA	510	15A8	397
12FQ7	134	12SH7	455	14BL11	394	16A8/PCL82	397
12FQ8	454	12SJ7	455	14BR11	395	16AP4	512
12FR8	454	12SJ7GT	342	14C5	455	16AP4A	512
12FT6	454	12SK7	455	14C7	455	16ABPA	512
12FV7	454	12SK7GT	343	14CP4	510	16ACP4	512
12FX5	454	12SL7GT	343	14CP4A	510	16AEP4	512
12FX8A	454	12SN7GTA	344	14CP4B	510	16AK9	455
12G8	454	12SQ7GT	345	14DP4	510	16ANPA	512
12G11	206	12SR7	455	14EP4	510	16AQ3	399
12GA6	454	12T10	347	14F7	455	16AQ3/XY88	399
12GB3	454	12U7	455	14F8	455	16AQP4	512
12GC6	454	12UP4	510	14GP4	510	16ASP4	512
12GE5	208	12UP4A	510	14GT8A	396	16ASP4A	514
12GN6	454	12UP4B	510	14HP4	510	16ATPA	512
12GN7A	391	12V6GT	354	14J8	455	16AUP4	512
12GN7A/12HG7	391	12VP4	510	14NP4	510	16AVPA	512
12GJ5	212	12VP4A	510	14NP4A	510	16AWPA	512
12GJ5A	214	12W6GT	356	14Q7	455	16AXPA	512
12GT5	224	12WP4	510	14QP4	510	16AYPA	512
12GT5A	225	12X4	357	14QP4A	510	16AZPA	512
12GW6	163	12YP4	510	14QP4B	510	16BAP4	512
12H6	454	12ZP4	510	14R7	455	16BDPA	512
12HE7	241	12ZP4A	510	14RP4	510	16BEP4	512
12HG7	391	13AP4	510	14RP4A	510	16BFP4	512
12HL5	454	13CW4	149	14SP4	510	16BGP4	512
12HL7	393	13DE7	157	14UP4	510	16BMP4	512
12HU8	258	13DR7	164	14WP4	510	16BNPA	512
12HU8/PLL80	258	13DP4	510	14XP4	510	16BRPA	512
12J5GT	454	13EM7	183	14XP4A	512	16BSP4	512
12J7GT	454	13FD7	194	14ZPA	512	16BUP4	512
12J8	454	13FM7	199	15AB9	455	16BVP4	512
12JB6	266	13FR7	455	15ADPA	512	16BWP4	512

Type	Page	Type	Page	Type	Page	Type	Page
16BXP4	512	16XP4	514	17CK3	137	17GT5	224
16BX11	455	16YP4	514	17CKP4	514	17GT5A	225
16BYP4	512	16ZP4	514	17CL3	137	17GV5	226
16CP4	512	17A8	368	17CLP4	514	17GW6	163
16CAP4	512	17AB9	455	17CMP4	514	17H3	456
16CDP22	504	17AB10	401	17CNP4	514	17HB25	456
16CEP4	512	17AP4	514	17CP4	514	17HC8	456
16CFP4	512	17ATP4	514	17CP4A	514	17HP4	516
16CHP4	512	17ATP4A	514	17CRP4	514	17HP4A	516
16CHP4A	512	17AV5GA	74	17CSP4	514	17HP4B	516
16CKP4	512	17AVP4	514	17CT3	147	17HP4C	516
16CMP4	512	17AVP4A	514	17CTP4	514	17JB6	266
16CMP4A	512	17AX3	77	17CU5	148	17JB6A	267
16CNP4	512	17AX4GTA	78	17CUP4	514	17JG6	456
16CQP4	512	17AX4GTA/17BMA	78	17CVP4	514	17JG6A	274
16CSP22	504	17AY3	79	17CWP4	514	17JK8	277
16CTP4	512	17AY3A	80	17CXP4	514	17JM6	279
16CUP4	512	17BB14	455	17CYP4	514	17JM6A	280
16CWP4	512	17BE3A	91	17CZP4	516	17JN6	281
16CXP4	512	17BF11	92	17D4A	155	17JN6A	282
16CYP22	504	17BF11A	402	17DAP4	516	17JP4	516
16DCP4	512	17BH3	94	17DBP4	516	17JQ6	456
16DCP4A	512	17BH3A	94	17DCP4	516	17JR6	456
16DP4	512	17BJP4	514	17DEA	156	17JT6	285
16DP4A	512	17BKP4	514	17DEP4	516	17JT6A	286
16DAP22	504	17BKP4A	514	17DHP4	516	17JZ8	292
16EP4	512	17BMP4	514	17DJP4	516	17KP4	516
16EP4A	512	17BNP4	514	17DKP4	516	17KP4A	516
16EP4B	512	17BP4	514	17DLP4	516	17KV6	456
16FP4	512	17BP4A	514	17DM4A	78	17KV6A	310
16GK6	216	17BP4B	514	17DQ4	162	17L6GT	456
16GP4	512	17BP4C	514	17DQ6B	163	17LD8	456
16GP4A	512	17BP4D	514	17DQ6B/17GW6	163	17LP4	516
16GP4B	512	17BQ6GTB	111	17DQP4	516	17LP4A	516
16GP4C	512	17BR3	456	17DRP4	516	17LP4B	516
16GY5	231	17BR3/17RK19	456	17DSP4	516	17QP4	516
16HP4	512	17BRP4	514	17DTP4	516	17QP4A	516
16HP4A	512	17BS3	115	17DW4A	170	17QP4B	516
16JP4	512	17BS3A	116	17DWP4	516	17R5	456
16JP4A	514	17BSP4	514	17DXP4	516	17RK19	456
16KA6	399	17BTP4	514	17DZP4	516	17RP4	516
16KP4	514	17BUP4	514	17EAP4	516	17RP4C	516
16KP4A	514	17BVP4	514	17EBP4	516	17SP4	516
16LP4	514	17BW3	411	17EFP4	516	17TP4	516
16LP4A	514	17BWP4	514	17EHP4	516	17UP4	516
16LU8	329	17BYP4	514	17EJP22	504	17VP4	516
16LU8A	400	17BZ3	123	17EKP4	516	17VP4B	516
16MP4	514	17BZP4	514	17ELP4	516	17W6GT	356
16MP4A	514	17C5	148	17EMP4	516	17X10	402
16QP4	514	17C5/17CU5	148	17ENP22	504	17YP4	516
16RP4	514	17C8	456	17EQP4	516	17Y9	362
16RP4A	514	17C9	456	17ESP4	516	17Z3	456
16RP4B	514	17C9A	456	17EW8	456	18A5	456
16SP4	514	17CA5	456	17EW8/HCC85	456	18AJ10	456
16TP4	514	17CAP4	514	17FP4	516	18DZ8	456
16UP4	514	17CBP4	514	17FP4A	516	18FW6A	403
16VP4	514	17CDP4	514	17GE5	208	18FX6A	404
16WP4	514	17CEP4	514	17GJ5	212	18FY6A	405
16WP4A	514	17CFP4	514	17GJ5A	214	18GB5	207
16WP4B	514	17CGP4	514	17GP4	516	18GD6A	406

Type	Page	Type	Page	Type	Page	Type	Page
18GE6A	456	19CUP4	518	19FLP4	520	20EQ7	184
18GV8	227	19CVP4	518	19FMP22	504	20EW7	191
18HB8	456	19CXP4	518	19FNP4	520	20EZ7	409
18RAL1	456	19CYP4	518	19FP4	520	20FP4	520
19ABP4	516	19CZP4	518	19FRP4	520	20GP4	520
19ACP4	516	19DAP4	518	19FTP4	520	20HP4	520
19AEP4	516	19DBP4	518	19FWP4	520	20HP4A	522
19AFP4	516	19DCP4	518	19FXP22	504	20HP4B	522
19AHP4	516	19DE3	457	19FZP4	520	20HP4C	522
19AJP4	516	19DE7	157	19GAP4	520	20HP4D	522
19ALP4	516	19DEP4	518	19GBP4	520	20HP4E	522
19ANP4	516	19DFP4	518	19GEP4	520	20JP4	522
19AP4	516	19DHP4	518	19GEP4A	520	20LP4	522
19AP4A	516	19DJP4	518	19GHP4	520	20MP4	522
19AP4B	516	19DKP4	518	19GJP4	520	20RP4	522
19AP4C	516	19DLP4	518	19GJP4A	520	20SP4	522
19AP4D	516	19DNP4	518	19GKP4	520	20TP4	522
19AQ5	63	19DP4	518	19GMP4	520	20UP4	522
19AQP4	516	19DP4A	518	19GQ7	222	20WP4	522
19ARP4	516	19DQP4	518	19GSP22	504	20XP4	522
19ASP4	516	19DRP4	518	19GVP22	504	20YP4	522
19ATP4	518	19DSP4	518	19GWP22	504	20ZP4	522
19AU4GTA	72	19DUP4	518	19GYP22	504	21AP4	522
19AUP4	518	19DVP4	518	19HBP22	504	21ACP4	522
19AVP4	518	19DWP4	518	19HCP22	504	21ACP4A	522
19AXP4	518	19DYP4	518	19HNP22	504	21AFP4	522
19AYP4	518	19DZP4	518	19HQP22	504	21ALP4	522
19BAP4	518	19EA8	175	19HAP4	520	21ALP4A	522
19BCP4	518	19EAP4	520	19HGP4	520	21ALP4B	522
19BDP4	518	19EBP4	520	19HR6	253	21AMP4	522
19BEP4	518	19ECP4	520	19HS6	254	21AMP4A	522
19BFP4	518	19EDP4	520	19HV8	406	21AMP4B	522
19BG6GA	456	19EFP4	520	19HRP22	504	21ANP4	522
19BHP4	518	19EGP4	520	19HXP22	504	21ANP4A	522
19BLP4	518	19EHP4	520	19HYP22	504	21AQP4	522
19BMP4	518	19EHP4A	520	19J6	261	21AQP4A	522
19BNP4	518	19EJP4	520	19JN8	283	21ARP4	522
19BQP4	518	19EKP4	520	19KG8	407	21ARP4A	522
19BRP4	518	19ELP4	520	19Q9	408	21ASP4	522
19BSP4	518	19ENP4	520	19T8	347	21ATP4	522
19BTP4	518	19ENP4A	520	19TP22	504	21ATP4A	522
19BUP4	518	19EP4	518	19V8	457	21ATP4B	522
19BVP4	518	19ESP4	520	19VP22	504	21AUP4	522
19BWP4	518	19ETP4	520	19X8	359	21AUP4A	522
19C8	457	19EUP4	520	19XP4	520	21AUP4B	522
19CAP4	518	19EW7	191	19YP4	520	21AUP4C	522
19CDP4	518	19EXP22	504	19ZP4	520	21AVP4	522
19CEP4	518	19EYP22	504	20ABP4	520	21AVP4A	522
19CFP4	518	19EZ8	193	20ADP4	520	21AVP4B	522
19CG3	133	19EZP4	520	20AEP4	520	21AVP4C	522
19CGP4	518	19FBP4	520	20CP4	520	21AWP4	522
19CHP4	518	19FCP4	520	20CP4A	520	21AWP4A	522
19CJP4	518	19FEP4	520	20CP4B	520	21AXP22	504
19CKP4	518	19FEP4A	520	20CP4C	520	21AXP22A	504
19CL8A	139	19FEP4B	520	20CP4D	520	21AYP4	522
19CLP4	518	19FGP4	520	20DP4	520	21BAP4	522
19CMP4	518	19FHP4	520	20DP4A	520	21BCP4	522
19CMP4A	518	19FJP4	520	20DP4B	520	21BDP4	522
19CQP4	518	19FJP4A	520	20DP4C	520	21BNP4	522
19CRP4	518	19FKP4	520	20DP4D	520	21BSP4	522

Type	Page	Type	Page	Type	Page	Type	Page
21BTP4	522	21FDP4	524	22BH3A	94	23CAP4	526
21CBP4	522	21FJP22	504	22BW3	411	23CBP4	526
21CBP4A	522	21FJP22A	504	22DE4	156	23CDP4	526
21CBP4B	522	21FKP22	504	22EP22	504	23CEP4	526
21CDP4	522	21FLP4	524	22JF6	273	23CGP4	526
21CDP4A	522	21FMP4	524	22JG6	457	23CMP4	526
21CEP4	522	21FP4	524	22JG6A	274	23CQP4	526
21CEP4A	522	21FP4A	524	22JP22	504	23CSP4	528
21CGP4	522	21FP4C	524	22JR6	457	23CTP4	528
21CHP4	522	21FP4D	524	22JU6	288	23CUP4	528
21CKP4	522	21FUP4	524	22KM6	300	23CVP4	528
21CLP4	522	21FVP4	524	22KP22	504	23CWP4	528
21CMP4	522	21FWP4	524	22KV6A	310	23CXP4	528
21CQP4	524	21FXP4	524	22LP22	504	23CZP4	528
21CSP4	524	21FYP4	524	22QP22	504	23DP4	528
21CUP4	524	21FZP4	524	22RP22	504	23DAP4	528
21CVP4	524	21GAP4	524	22SP22	504	23DBP4	528
21CWP4	524	21GAP4A	524	22TP4	526	23DCP4	528
21CXP4	524	21GBP4	524	22UP22	504	23DEP4	528
21CYP22	504	21GCP4	524	22ZP4	526	23DFP4	528
21CYP22A	504	21GFP22	504	23ACP4	526	23DHP4	528
21CZP4	524	21GNP4	524	23AFP4	526	23DJP4	528
21DP4	524	21GJP4	524	23AHP4	526	23DKP4	528
21DAP4	524	21GKP4	524	23AKP4	526	23DLP4	528
21DEP4	524	21GLP22	504	23ALP4	526	23DLP4A	528
21DEP4A	524	21GTP4	524	23AMP4	526	23DNP4	528
21DFP4	524	21GY5	231	23ANP4	526	23DQP4	528
21DHP4	524	21GUP22	504	23AQP4	526	23DSP4	528
21DJP4	524	21GVP22	504	23ARP4	526	23DSP4A	528
21DKP4	524	21GWP22	504	23ASP4	526	23DTP4	528
21DKP4A	524	21GYP22	504	23ATP4	526	23DVP4	528
21DLP4	524	21HB5	235	23AUP4	526	23DVP4A	528
21DMP4	524	21HB5A	410	23AVP4	526	23DWP4	528
21DNP4	524	21HD5	457	23AWP4	526	23DYP4	528
21DQP4	524	21HJ5	246	23AXP4	526	23DZP4	528
21DRP4	524	21JP4	524	23AYP4	526	23EP4	528
21DSP4	524	21JPA	524	23AZP4	526	23EAP4	528
21DVP4	524	21JZ6	291	23BP4	526	23ECP4	528
21DWP4	524	21KA6	399	23BAP4	526	23EDP4	528
21EAP4	524	21KP4	526	23BCP4	526	23EFP4	528
21ELP4	524	21KP4A	526	23BDP4	526	23EGP22	504
21EMP4	524	21KQ6	410	23BEP4	526	23EGP22A	506
21ENP4	524	21LG6	457	23BEP4A	526	23EKP4	528
21EP4	524	21LR8	327	23BGP4	526	23ENP4	528
21EP4A	524	21LU8	329	23BHP4	526	23EQP4	528
21EP4B	524	21MP4	526	23BJP4	526	23ERP4	528
21EP4C	524	21WP4	526	23BKP4	526	23ESP4	528
21EQP4	524	21WP4A	526	23BLP4	526	23ESP4A	528
21ERP4	524	21WP4B	526	23BMP4	526	23ETP4	528
21ESP4	524	21XP4	526	23BNP4	526	23EWP4	528
21EVP4	524	21XP4A	526	23BP4	526	23EWP4A	528
21EWP4	524	21XP4B	526	23BRP4	526	23EYP4	528
21EX6	457	21YP4	526	23BSP4	526	23EZP4	528
21EXP4	524	21YP4A	526	23BTP4	526	23FP4	528
21EYP4	524	21YP4B	526	23BVP4	526	23FP4A	528
21EZP4	524	21ZP4	526	23BXP4	526	23FAP4	528
21FAP4	524	21ZP4A	526	23BYP4	526	23FBP4	528
21FBP22	504	21ZP4B	526	23BZP4	526	23FCP4	528
21FBP22A	504	21ZP4C	526	23CP4	526	23FDP4	528
21FCP4	524	22BH3	94	23CP4A	526	23FHP4	528

Type	Page	Type	Page	Type	Page	Type	Page
23FKP4	528	23Z9	412	25BR3	457	28D7	457
23FLP4	528	23ZP4	530	25C5	148	28D7W	457
23FMP4	528	24ADP4	530	25CA5	457	GB28D7W	457
23FRP4	528	24AEP4	530	25CD6GB	132	28GB5	207
23FRP4	528	24AHP4	530	25CG3	133	28HA6	457
23FSP4	528	24AJP4	530	25CK3	137	28HD5	457
23FVP4	528	24ALP4	530	25CP22	506	29KQ6	410
23FVP4A	528	24AMP4	530	25CM3	140	30AG11	53
23FWP4	528	24ANP4	530	25CU6	111	30BP4	532
23FWP4A	528	24AP4	530	25DK4	457	30CW5	150
23GP4	528	24AP4A	530	25DN6	457	30HD5	457
23GBP4	528	24AP4B	530	25DP4	532	30HJ5	246
23GDP4	528	24AQP4	530	25DQ6A	457	30KD6	298
23GHP4	530	24ASP4	530	25DT5	167	31AL10	458
23GJP4	530	24ATP4	530	25E5	457	31JS6C	284
23GJP4A	530	24AUP4	530	25EC6	457	31LQ6	271
23GKP4	530	24AVP4	530	25EH5	178	32ET5A	413
23GRP4	530	24AWP4	530	25EP4	532	32HQ7	458
23GSP4	530	24AXP4	530	25F5A	457	33GT7	414
23GTP4	530	24BP4	530	25FP22	506	33GY7A	415
23GVP4	530	24BAP4	532	25GP22	506	33HE7	241
23GWP4	530	24BCP4	532	25HP4	532	33JV6	416
23GXP4	530	24BEP4	532	25JP4	532	34CD3	133
23HP4	530	24BF11	92	25JQ6	457	34CE3	133
23HBP4	530	24CP4	532	25JZ8	292	34GM3	140
23HFP4	530	24CP4A	532	25KP4	532	34GD5A	417
23HFP4A	530	24CP4B	532	25LG6T	457	34R3	458
23HGP4	530	24DPP4	532	25LP4	532	35A5	458
23HHP4	530	24DP4A	532	25TP4	532	35B5	458
23HMP4	530	24JE6A	271	25W4GT	355	35C5	418
23HQP4	530	24LQ6	271	25W6GT	356	35CD6GA	132
23HRP4	530	24JZ8	292	25WP22	506	35DZ8	458
23HTP4	530	24QP4	532	25XP22	506	35EH5	458
23HUP4	530	24TP4	532	25YP22	506	35EH5A	178
23HUP4A	530	24VP4	532	25Z5	457	35GL6	458
23HWP4	530	24VP4A	532	25Z6GT	457	35HB8	458
23HWP4A	530	24XP4	532	25ZP22	506	35L6GT	458
23HXP4	530	24YP4	532	26HU5	457	35W4	418
23HZP4	530	24ZP4	532	27AP4	532	35LR6	458
23JP4	530	25AP22	506	27ABP4	532	35Y4	458
23JAP4	530	25AP22A	506	27ACP4	532	35Z3	458
23JBP4	530	25ABP22	506	27ADP4	532	35Z5GT	419
23JEP4	530	25AEP22	506	27AEP4	532	36AM3B	420
23JFP4	530	25AFP22	506	27AFP4	532	36KD6	298
23JGP4	530	25AJP22	506	27AGP4	532	38HE7	241
23JLP4	530	25AKP22	506	27EP4	532	38HK7	458
23JS6A	284	25ALP22	506	27GB5	207	40A1	458
23KP4	530	25ANP22	506	27GB5/PL500	207	40B2	458
23KP4A	530	25AQP22	506	27GP4	532	40FR5	458
23MP4	530	25AWP22	506	27LP4	532	40KD6	298
23MP4A	530	25AYP22	506	27MP4	532	41	458
23NP4	530	25AZP22	506	27NP4	532	42	458
23RP4	530	25AV5GA	74	27RP4	532	42KN6	302
23SP4	530	25AX4GT	457	27RPA4	532	43	458
23TP4	530	25BB14	457	27SPA4	532	45	458
23UP4	530	25BK5	457	27UP4	532	45B5	458
23VP4	530	25BP22	506	27VP4	532	50A1	458
23WP4	530	25BP22A	506	27XP4	532	50A5	459
23XP4	530	25BQ6GTB	111	27YP4	532	50AX6G	459
23YP4	530	25BQ6GTB/ZC6	111	27ZP4	532	50B5	421

Type	Page	Type	Page	Type	Page	Type	Page
50BK5	459	1266	461	5751	462	6005/6AQ5W	464
50BM8	459	1267	461	5751WA	462	GB-6005	464
50C5	148	1273	461	GB-5751	462	6021	464
50DC4	421	1274	461	5763	462	6028	464
50EH5	459	1275	461	5783	462	6080	464
50EH5A	178	1276	461	5784	462	GB-6080	464
50FA5	459	1280	461	5785	462	6082A	464
50FE5	459	1284	461	5787	462	6095	464
50FK5	459	1291	461	5814	462	6096	464
50FY8	459	1293	461	5814WA	462	6097	464
50HC6	422	1294	461	GB-5814A	462	6098	464
50HK6	423	1299	461	5823	462	6099	464
50HN5	459	1612	461	5824	462	6100	464
50JY6	424	1614	461	5840	462	6101	464
50L6GT	459	1625	461	5842	462	GB-6101	464
50X6	459	2050A	461	5844	463	6110	464
50Y6GT	459	5636	461	GB-5844	463	6111	464
50Y7GT	459	5639	461	5845	463	6112	464
53HK7	459	5641	461	5847A	463	6118	464
56R9	459	5642	461	5851	463	6135	464
58HE7	241	5643	461	5871	463	GB-6135	464
60E3	459	5644	461	5879	463	GB-6136	464
60FX5	459	5647	461	5881	463	6145	464
60HLS	459	5651	461	5889	463	GB-6145	464
KT66	459	5651WA	461	5896	463	6146B	464
75	459	5654/6AK5W	461	5899	463	6146B/8298A	425
78	459	5654/6AK5W/6096	461	5902	463	6147	465
80	459	GB5654	461	5903	463	6159B	465
83	459	5670	461	5904	463	6186	465
84	459	GB-5670	461	5905	463	6186/6AG5WA	465
84/624	459	5670WA	461	5906	463	GB-6186	465
407A	460	5686	461	5907	463	6187	465
GB-407A	460	5687	461	5908	463	6188	465
408A	460	GB-5687	461	5910	463	6189	465
GB-408A	460	5691	461	5915	463	6189/12AU7WA	465
417A	460	5692	461	5915A	463	GB-6189	465
807	460	5693	461	GB-5915A	463	6197	465
807W	460	5702	462	5916	463	6201	465
884	460	5702WA	462	5931	463	GB-6201	465
117L7/M7GT	460	5702WB	462	GB-5931	463	6205	465
117Z3	460	5703	462	5932	463	6206	465
117Z6GT	460	5703WA	462	GB-5932	463	6211A	465
1216	460	5703WB	462	5933	463	6216	465
GB-1216	460	5704	462	5933WA	463	6267	465
1217	460	5718	462	GB-5933	463	6308	465
GB-1217	460	5719	462	5963	463	6336A	465
1218A	460	5722	462	GB-5963	463	6350	465
GB-1220/5654	460	5725	462	5964	463	GB-6350	465
1221	460	GB-5725	462	GB-5964	463	6352	465
1222A	460	5725/6A56W	462	5965A	463	6354	465
1223	460	5726/6AL5W	462	GB-5965	463	6394A	465
1229	460	5726/6AL5W/6097	462	5968	463	6418	465
1230	460	GB-5726	462	5969	463	6463	465
1231	460	GB-5727	462	5970	463	6483	465
1232	460	5744	462	5977	463	6486A	465
1236A	460	5749/6BA6W	462	5987	464	6516	465
1238	460	GB-5749	462	5998A	464	6520	465
1247	460	5750	462	6000	464	6528	465
GB-1252/6U8A	460	5750/6BE6W	462	6005	464	6550	465
1265	460	GB-5750	462	6005/6AQ5W/6095	464	6582A	465



Type	Page	Type	Page	Type	Page	Type	Page
6611	466	7077	468	7690	470	8211	473
6612	466	7105	468	7693	470	8212	473
6626	466	7119	468	7694	470	8213	473
6627	466	7137	468	7695	470	8223	473
6660/6BA6	466	GB-7137	468	7701	470	8233	473
6661/6BH6	466	7150	468	7716	470	8254	473
6662/6BJ6	466	7167	468	7717	470	8278	473
6663/6AL5	466	7189	468	7719	470	8298A	425
6664/6AB4	466	7189A	428	7720	471	8319	473
6669/6AQ5	466	7199	429	7721	471	8334	473
6669/6AQ5A	466	7212	468	7722	471	8358	473
6676/6CB6A	466	7227	468	7724	471	8380	473
6677/6CL6	466	7233	468	7728	471	8382	473
6678/6U8A	466	7236	468	7729	471	8414	473
6679/12AT7	466	7239	468	7730	471	8417	473
6680/12AU7A	466	7241	468	7731	471	8425	473
6681/12AX7	466	7242	468	7732	471	8426	473
6690	466	7244A	468	7733	471	8431	473
6788	466	7245	468	7734	471	8441	473
GB-6814	466	7246	468	7737	471	8444	473
6832	466	7258	468	7738	471	8445	473
6840	466	7308	469	7751	471	8446	473
6851	466	7316	469	7754	471	8447	473
6853	466	7318	469	7759	471	8448	473
6854	466	7320	469	7760	471	8456	473
6870	466	7327	469	7761	471	8489	473
6872	466	7355	469	7762	471	8532	473
6877	466	7358	469	7763	471	8632	473
6883	467	7360	469	7768	471	9001	473
6893	467	7370	469	7803	471	9002	474
6900	467	7382	469	7841	471	9003	474
6919	467	7408	469	7861	471	DY87	436
6922	467	7430	469	7867	471	EABC80	441
6939	467	7489	469	7868	472	ECC88	443
6943	467	7490	469	7887	472	ECC81	380
6944	467	7492	469	7888	472	ECC82	382
6945	467	7494	469	7889	472	ECC83	384
6946	467	7495	469	7898	472	ECC85	65
6948	467	7496	469	7905	472	ECC189	186
6954	467	7498	469	7984	472	ECF80	104
6955	467	7499	469	7994	472	ECF86	245
6968	467	7500	469	7995	472	ECF200	360
6973	427	7502	469	8056	472	ECF801	214
6977	467	7543	430	8058	472	ECF802	290
7001	467	7550	469	8064	472	ECG100	549
7025	428	GB-7550	469	8068	472	ECG101	549
7025A	467	7551	469	8070	472	ECG102	549
7027A	467	7558	469	8071	472	ECG102A	549
7032	467	7561	470	8084	472	ECG103	549
7036	467	7576	470	8102	472	ECG103A	549
7044	467	7581A	470	8103	472	ECG104	549
GB-7044	467	7586	470	8106	472	ECG104MP	549
7054	467	7587	470	8113	472	ECG105	549
7055	467	7591	470	8136	472	ECG106	549
7056	467	7591A	431	8149	472	ECG107	549
7057	467	7631	470	8150	472	ECG108	550
7058	467	7643	470	8156	472	ECG109	551
7059	468	7687	470	8185	472	ECG110	551
7060	468	7688	470	8186	473	ECG111	551
7061	468	7689	470	8210	473	ECG112	551

Type	Page	Type	Page	Type	Page	Type	Page
<b>ECG113</b> .....	551	<b>ECG135</b> .....	552	<b>ECG372</b> .....	555	<b>KT66</b> .....	459
<b>ECG114</b> .....	552	<b>ECG136</b> .....	552	<b>ECG703</b> .....	556	<b>KT88</b> .....	459
<b>ECG115</b> .....	552	<b>ECG137</b> .....	552	<b>ECG704</b> .....	556	<b>LCF86</b> .....	245
<b>ECG116</b> .....	552	<b>ECG138</b> .....	552	<b>ECG705</b> .....	556	<b>LCF201</b> .....	350
<b>ECG117</b> .....	552	<b>ECG139</b> .....	552	<b>ECG716</b> .....	556	<b>LCF802</b> .....	330
<b>ECG118</b> .....	552	<b>ECG140</b> .....	552	<b>ECL80</b> .....	440	<b>LCL84</b> .....	171
<b>ECG119</b> .....	552	<b>ECG141</b> .....	552	<b>ECL82</b> .....	105	<b>LFL200</b> .....	362
<b>ECG120</b> .....	552	<b>ECG142</b> .....	552	<b>ECL84</b> .....	171	<b>LL86</b> .....	150
<b>ECG121</b> .....	550	<b>ECG143</b> .....	552	<b>ECL86</b> .....	229	<b>PC900</b> .....	234
<b>ECG121MP</b> .....	550	<b>ECG144</b> .....	552	<b>EF80</b> .....	442	<b>PCF80</b> .....	368
<b>ECG122</b> .....	552	<b>ECG145</b> .....	552	<b>EF93</b> .....	83	<b>PCF86</b> .....	245
<b>ECG123</b> .....	550	<b>ECG146</b> .....	552	<b>EF95</b> .....	56	<b>PCF801</b> .....	214
<b>ECG123A</b> .....	550	<b>ECG147</b> .....	552	<b>EF183</b> .....	179	<b>PCL82</b> .....	397
<b>ECG124</b> .....	550	<b>ECG148</b> .....	552	<b>EF184</b> .....	181	<b>PL84</b> .....	150
<b>ECG125</b> .....	552	<b>ECG149</b> .....	552	<b>EL34</b> .....	127	<b>PL500</b> .....	207
<b>ECG126</b> .....	550	<b>ECG150</b> .....	552	<b>EL84</b> .....	110	<b>TT19</b> .....	506
<b>ECG127</b> .....	550	<b>ECG151</b> .....	552	<b>EL86</b> .....	150	<b>TT19B</b> .....	506
<b>ECG128</b> .....	550	<b>ECG152</b> .....	550	<b>EL500</b> .....	207	<b>TT21</b> .....	506
<b>ECG129</b> .....	550	<b>ECG153</b> .....	551	<b>ELL80</b> .....	258	<b>VR90-105-150</b> .....	459
<b>ECG130</b> .....	550	<b>ECG154</b> .....	551	<b>EM84</b> .....	445	<b>XCF80</b> .....	104
<b>ECG130MP</b> .....	550	<b>ECG155</b> .....	551	<b>EM87</b> .....	445	<b>XF183</b> .....	179
<b>ECG131</b> .....	550	<b>ECG156</b> .....	552	<b>EY88</b> .....	57	<b>XF184</b> .....	181
<b>ECG131MP</b> .....	550	<b>ECG157</b> .....	551	<b>EZ80</b> .....	448	<b>XL500</b> .....	207
<b>ECG132</b> .....	551	<b>ECG303</b> .....	554	<b>FM1000</b> .....	460	<b>XY88</b> .....	399
<b>ECG133</b> .....	551	<b>ECG370</b> .....	555	<b>GZ34</b> .....	37	<b>XXD</b> .....	474
<b>ECG134</b> .....	552	<b>ECG371</b> .....	555	<b>HCC85</b> .....	456	<b>XXFM</b> .....	474
						<b>XXL</b> .....	474

# RECEIVING TUBES

	Page
Data for Popular Types .....	19
Condensed Data Section .....	433
Basing Diagrams .....	474
General Data .....	488
Replacement Guides	
Sylvania Double/Brand .....	490
Foreign-American .....	492
Industrial .....	500

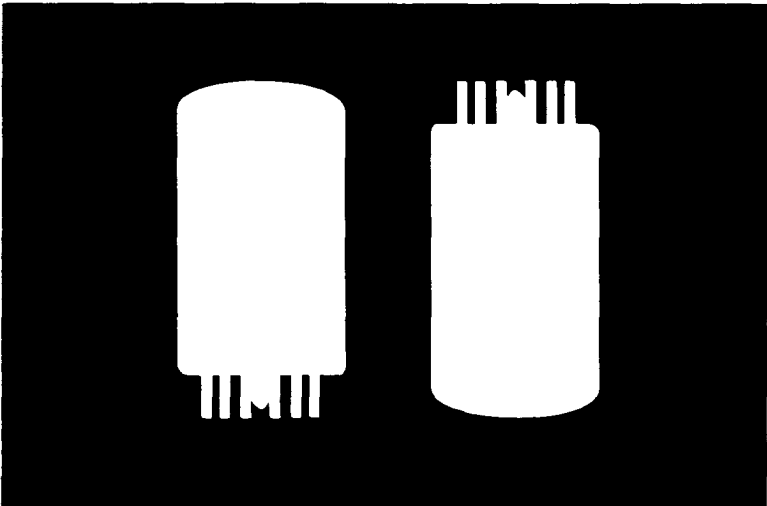

**TYPICAL COLOR RECEIVER (simplified block diagram)**

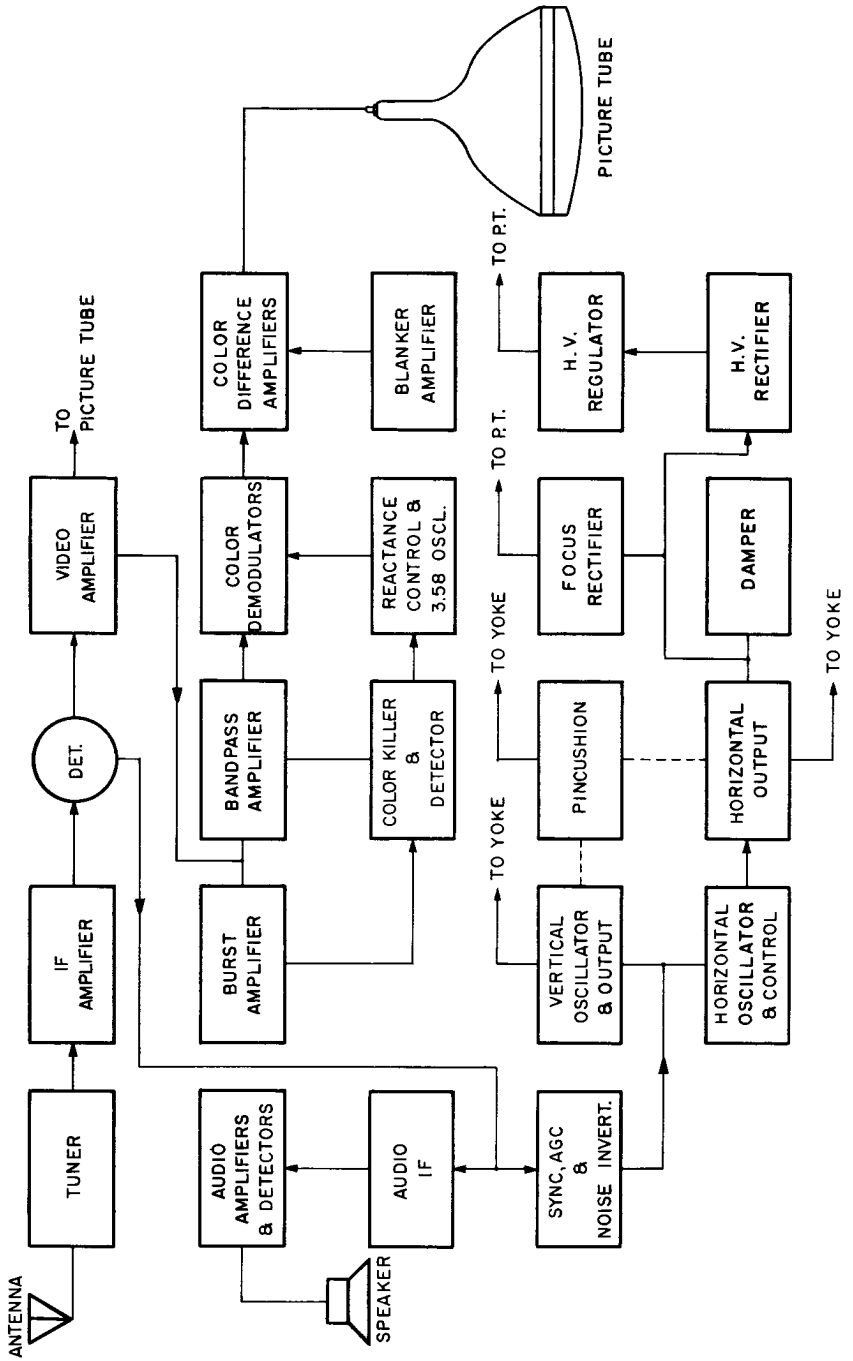

**FULL WAVE GAS RECTIFIER**

**OZ4**

OZ4A, OZ4G

**Cold Cathode Diode**

Construction  
 OZ4, OZ4A.....Metal MT8  
 OZ4G.....Glass T-7  
 Base.....Octal  
 Basing.....4R  
 Outline  
 Maximum Diameter.....1.031 In.  
 Maximum Seated Height.....2.063 In.  
 Maximum Overall Height.....2.625 In.

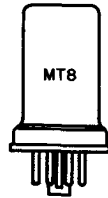
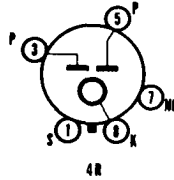

**ELECTRICAL DATA**

**HEATER OPERATION**

Heater Voltage.....None Required

**RATINGS (Design Center Rating System)**

	OZ4, OZ4G	OZ4A
Peak Starting Plate Supply Voltage (Min.)	300	300 Volts
Peak Inverse Plate Voltage	880	880 Volts
Peak Plate Current	270	330 Ma
DC Output Current (Max.)	90	110 Ma
DC Output Current (Min.)	30	30 Ma

**CHARACTERISTICS AND TYPICAL OPERATION**

	OZ4, OZ4G	OZ4A
Peak Plate Voltage (Per Plate)	380	440 Volts
Filter Input Condenser	8	8 $\mu$ f
Total Effective Plate Supply Impedance (Per Plate)	800	600 Ohms
Voltage Drop for $I_b = 110$ Ma (Per Plate)	—	24 Volts
Voltage Drop for $I_b = 90$ Ma (Per Plate)	24	— Volts
DC Output Current	65	110 Ma
DC Output Voltage	275	310 Volts

Color Television Type

**HIGH VOLTAGE RECTIFIER**

**1AD2**

**Filamentary Diode**

Construction.....Compactron T-9  
 Base.....Button 12 Pin, E12-70  
 Top Cap.....Small, C1-34  
 Basing<sup>(1)</sup>.....12GV  
 Outline  
 Maximum Diameter.....1.188 In.  
 Maximum Seated Height.....2.750 In.  
 Maximum Overall Height.....3.125 In.

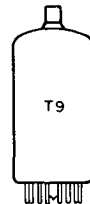
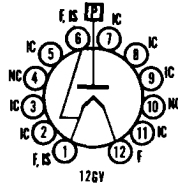

**ELECTRICAL DATA**

**FILAMENT OPERATION**

Filament Voltage<sup>(1)</sup>.....1.25 Volts  
 Filament Current.....200 Ma

**DIRECT INTERELECTRODE CAPACITANCES**

Plate to Filament.....1.6 Pf

**RATINGS (Design Maximum Rating System)**

**Pulse Rectifier Service<sup>(2)</sup>**

Peak Inverse Plate Voltage (Max.).....26,000 Volts  
 Peak Plate Current (Max.).....50 Ma  
 Average Plate Current (Max.).....0.5 Ma

**CHARACTERISTICS AND TYPICAL OPERATION**

Tube Voltage Drop for  $I_b = 7.0$  Ma.....225 Volts

**NOTES:**

- (1) Under no circumstance should voltage fall below 1.05 volts or exceed 1.45 volts.
- (2) For operation in a 525 line, 30 frame system as described in "Standards of Good Engineering Practice for Television Broadcast Stations; Federal Communications Commission," the duty cycle of the voltage pulse must not exceed 15% of one horizontal scanning cycle.

(3) Terminals 4 and 10 may be used as tie points for components at or near filament potential.

**X-RADIATION WARNING:** The high voltages associated with this tube type result in the production of X-radiation which may constitute a health hazard on prolonged exposure at close range unless the tube is adequately shielded. Precautions must be exercised during the servicing of equipment to assure that all shielding components are replaced to their intended positions before the equipment is operated.

# 1AY2

## HIGH VOLTAGE RECTIFIER

### Filamentary Diode

Construction .....T-9  
 Base .....Button 2 Pin, E2-92  
 Top Cap .....Small, C1-34  
 Basing.....Special 2 Pin  
 Outline  
 Maximum Diameter .....1.188 In.  
 Maximum Seated Height .....2.680 In.  
 Maximum Overall Height .....3.060 In.

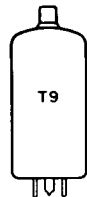
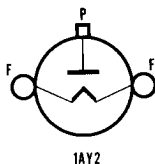

### ELECTRICAL DATA

#### FILAMENT OPERATION

Filament Voltage<sup>(1)</sup> ..... 1.25 Volts  
 Filament Current ..... 200 Ma

#### DIRECT INTERELECTRODE CAPACITANCES

Plate to Filament ..... 1.4 Pf

#### RATINGS (Design Maximum Rating System)

##### Pulse Rectifier Service<sup>(2)</sup>

Peak Inverse Plate Voltage (Max.) ..... 26,000 Volts  
 Peak Plate Current (Max.) ..... 50 Ma  
 Average Plate Current (Max.) ..... 0.5 Ma

#### CHARACTERISTICS AND TYPICAL OPERATION

Tube Voltage Drop for  $I_b = 7$  Ma ..... 75 Volts

### NOTES:

- (1) Under no circumstances should voltage fall below 1.05 volts or exceed 1.45 volts.
- (2) For operation in a 525 line, 30 frame system as described in "Standards of Good Engineering Practice for Television Broadcast Stations; Federal Communications Commission," the duty cycle of the voltage pulse must not exceed 15% of one horizontal scanning cycle.

**X-RADIATION WARNING:** The high voltages associated with this tube type result in the production of X-radiation which may constitute a health hazard on prolonged exposure at close range unless the tube is adequately shielded. Precautions must be exercised during the servicing of equipment to assure that all shielding components are replaced to their intended positions before the equipment is operated.

# 1BC2

## HIGH VOLTAGE RECTIFIER

### Filamentary Diode

Construction .....Miniature T-6½  
 Base .....Small Button 9 Pin, E9-1  
 Top Cap .....C1-45  
 Basing<sup>(a)</sup> .....9RG  
 Outline  
 Maximum Diameter .....0.875 In.  
 Maximum Seated Height .....2.250 In.  
 Maximum Overall Height .....2.531 In.

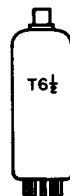
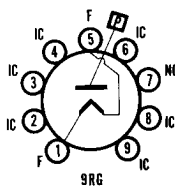

**ELECTRICAL DATA**

**FILAMENT OPERATION**

Filament Voltage <sup>(1)</sup> .....	1.25 Volts
Filament Current .....	200 Ma

**DIRECT INTERELECTRODE CAPACITANCES**

Plate to Filament .....	1.0 Pf
-------------------------	--------

**RATINGS (Design Maximum Rating System)**

**Pulse Rectifier Service<sup>(2)</sup>**

Peak Inverse Plate Voltage (Max.) .....	15,000 Volts
Peak Plate Current (Max.) .....	45 Ma
Average Plate Current (Max.) .....	0.5 Ma

**CHARACTERISTICS AND TYPICAL OPERATION**

Tube Voltage Drop for Ib = 7 Ma .....	80 Volts
---------------------------------------	----------

**NOTES:**

- (1) Under no circumstances should voltage fall below 1.05 volts or exceed 1.45 volts.
- (2) For operation in a 525 line, 30 frame system as described in "Standards of Good Engineering Practice for Television Broadcast Stations; Federal Communications Commission," the duty cycle of the voltage pulse must not exceed 15% of one horizontal scanning cycle.
- (3) Pin No. 7 may be used as tie-point for filament resistor or tied directly to filament. Do not connect to any other circuit.

**X-RADIATION WARNING:** The high voltages associated with this tube type result in the production of X-radiation which may constitute a health hazard on prolonged exposure at close range unless the tube is adequately shielded. Precautions must be exercised during the servicing of equipment to assure that all shielding components are replaced to their intended positions before the equipment is operated.

**HIGH VOLTAGE RECTIFIER**

**1BH2**

**Filamentary Diode**

Construction .....	Miniature T-6½
Base .....	Small Button 9 Pin, E9-99
	With Solders Lugs on Pins 1 and 5
Top Cap .....	C1-45
Basing .....	9RG
Outline	
Maximum Diameter .....	0.875 In.
Maximum Seated Height .....	2.250 In.
Maximum Overall Height .....	2.716 In.

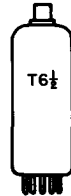
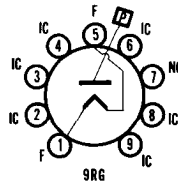

**ELECTRICAL DATA**

**FILAMENT OPERATION**

Filament Voltage <sup>(1)</sup> .....	1.25 Volts
Filament Current .....	200 Ma

**DIRECT INTERELECTRODE CAPACITANCES**

Plate to Filament .....	1.0 Pf
-------------------------	--------

**RATINGS (Design Maximum Rating System)**

**Pulse Rectifier Service<sup>(2)</sup>**

Peak Inverse Plate Voltage (Max.) .....	18,000 Volts
Peak Plate Current (Max.) .....	45 Ma
Average Plate Current (Max.) .....	0.5 Ma

**CHARACTERISTICS AND TYPICAL OPERATION**

Tube Voltage Drop for Ib = 7 Ma .....	80 Volts
---------------------------------------	----------

**NOTES:**

- (1) Under no circumstances should voltage fall below 1.05 volts or exceed 1.45 volts.
- (2) For operation in a 525-line, 30-frame system as described in "Standards of Good Engineering Practice for Television Broadcast Stations; Federal Communications Commission," the duty cycle of the voltage pulse must not exceed 15% of one horizontal scanning cycle.

**X-RADIATION WARNING:** The high voltages associated with this tube type result in the production of X-radiation which may constitute a health hazard on prolonged exposure at close range unless the tube is adequately shielded. Precautions must be exercised during the servicing of equipment to assure that all shielding components are replaced to their intended positions before the equipment is operated.

**1BY2**

Color Television Type  
**HIGH VOLTAGE RECTIFIER**

**Filamentary Diode**

Construction .....	T-9
Base .....	E12-70
Top Cap .....	C1-1 or C1-34
Basing <sup>(3)</sup> .....	12HZ
Outline .....	9-98
Maximum Diameter .....	1.188 In.
Maximum Seated Height .....	2.750 In.
Maximum Overall Height .....	3.125 In.

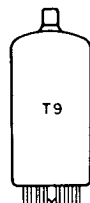
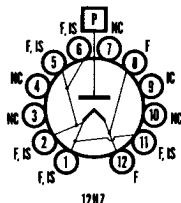
**ELECTRICAL DATA****FILAMENT OPERATION**

Filament Voltage <sup>(1)</sup> .....	1.25 Volts
Filament Current .....	200 Ma

**DIRECT INTERELECTRODE CAPACITANCES**

Plate to Filament and Internal Shield .....	<b>Without Shield</b> 1.6 pf
---	---------------------------------

**RATINGS (Design Maximum Rating System)****Pulse Rectifier Service<sup>(2)</sup>**

Peak Inverse Plate Voltage	
Total DC and Peak (Absolute Max.) .....	26,000 Volts
DC Component (Absolute Max.) .....	22,000 Volts
Steady State Peak Plate Current (Design Max.) .....	50 Ma
Average Plate Current (DC Output) (Design Max.) .....	0.5 Ma

**AVERAGE CHARACTERISTICS**

Instantaneous Tube Drop (Approx.) for $I_b = 7.0$ Ma .....	225 Volts
--	-----------

**X-RADIATION CHARACTERISTICS**

Maximum X-Radiation ..... 25.0 mR/h  
 X-Radiation is measured in accordance with JEDEC Publication No. 67, "Recommended Practice for Measurement of X-Radiation from Receiving Tubes," dated February 1968 and quality controlled in accordance with JEDEC Publication No. 73, "Recommended Practice for Quality Control of X-Radiation Emitted from High Voltage Rectifier and Shunt Regulator Receiving Tubes."

Lot acceptance sampling procedures for the manufacturer's initial and life tests for X-Radiation are based upon MIL-STD-105, "Military Standard Sampling Procedures and Tables for Inspection by Attributes." Lot acceptance and life control limits are established substantially below the X-Radiation Characteristic Maximum.

**NOTES:**

- (1) Under no circumstances should voltage fall below 1.05 volts or exceed 1.45 volts.
- (2) For operation in a 525 line, 30-frame system as described in "Standards of Good Engineering Practice for Television Broadcast Stations; Federal Communications Commission;" the duty cycle of the voltage pulse must not exceed 15% of one horizontal scanning cycle.
- (3) Only pins 4 and 10 may be used as tie points at or near filament potential. Pins 3, 7 and 9 are not to be used as tie points for external components. Pins 1 and 2 are to be utilized as the high voltage output filament terminal. Pins 8 or 12 are to be utilized as the low side filament terminal. Good high voltage practice dictates that a minimum of one half inch be maintained between the tube envelope and the filament and/or DC output leads.

**X-RADIATION WARNING:** The high voltages associated with this tube type result in the production of X-radiation which may constitute a health hazard on prolonged exposure at close range unless the tube is adequately shielded. Precautions must be exercised during the servicing of equipment to assure that all shielding components are replaced to their intended positions before the equipment is operated.



*Color Television Type*

## HIGH VOLTAGE RECTIFIER

# 1G3GT/1B3GT

### Filamentary Diode

Construction ..... Octal T-9  
 Base<sup>(1)</sup> ..... B5-82, B6-8, B6-60, B6-144  
                     B7-166, B7-211, B8-6 or B8-58  
 Top Cap ..... Small, C1-34  
 Basing<sup>(2)</sup> ..... 3C  
 Outline<sup>(3)</sup> ..... 9-51 or 9-52  
 Maximum Diameter ..... 1.188 In.  
 Maximum Seated Height ..... 3.312 In.  
 Maximum Overall Height ..... 4.062 In.

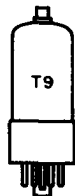
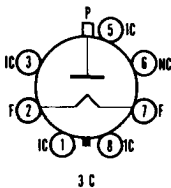

### ELECTRICAL DATA

#### FILAMENT OPERATION

Filament Voltage <sup>(3)</sup> .....	1.25 Volts
Filament Current .....	200 Ma

#### DIRECT INTERELECTRODE CAPACITANCES

Plate to Filament and Internal Shield .....	1.3 Pf
---	--------

#### RATINGS (Design Maximum Rating System)

##### Pulse Rectifier Service<sup>(4)</sup>

Peak Inverse Plate Voltage	
Total DC and Peak (Max.) .....	26,000 Volts
DC (Max.) .....	22,000 Volts
Peak Plate Current (Max.) .....	50 Ma
Average Plate Current (Max.) .....	0.5 Ma

##### RF Voltage Rectifier

Peak Inverse Plate Voltage (Max.) .....	33,000 Volts
Peak Plate Current (Max.) .....	35 Ma
Average Plate Current (Max.) .....	1.1 Ma
Frequency of Supply Voltage (Max.) .....	100 KHz
(Min.) .....	1.5 KHz

#### CHARACTERISTICS AND TYPICAL OPERATION

Tube Voltage Drop for Ib = 7.0 Ma (Approx.) .....	100 Volts
---	-----------

#### NOTES:

- (1) On the 5 pin bases, Pins 1, 4, and 6 are omitted. On the 6 pin bases, Pins 4 and 6 are omitted. On 7 pin bases, Pin 4 is omitted.
- (2) Socket terminals 1, 3, 4, 5, 6, and 8 may be connected to terminal 7 or to a corona shield which connects to terminal 7. Terminals 4 and 6 may be used as tie points for components at or near filament potential.
- (3) Under no circumstances should the filament voltage be less than 1.05 volts or more than 1.45 volts.
- (4) For operation in a 525-line, 30-frame system as described in "Standards of Good Engineering Practice for Television Broadcast Stations; Federal Communications Commission," the duty cycle of the voltage pulse must not exceed 15% of one horizontal scanning cycle.

**X-RADIATION WARNING:** The high voltages associated with this tube type result in the production of X-radiation which may constitute a health hazard on prolonged exposure at close range unless the tube is adequately shielded. Precautions must be exercised during the servicing of equipment to assure that all shielding components are replaced to their intended positions before the equipment is operated.

## HIGH VOLTAGE RECTIFIER

# 1K3/1J3

### Filamentary Diode

Construction ..... Octal T-9  
 Base<sup>(1)</sup> ..... B6-8 or B6-60  
 Top Cap ..... Small, C1-34  
 Basing<sup>(2)</sup> ..... 3C  
 Outline<sup>(3)</sup> ..... 9-53 or 9-54  
 Maximum Diameter ..... 1.188 In.  
 Maximum Seated Height ..... 3.000 In.  
 Maximum Overall Height ..... 3.562 In.

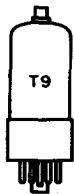
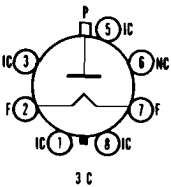

**ELECTRICAL DATA**

**FILAMENT OPERATION**

Filament Voltage <sup>(4)</sup> .....	1.25 Volts
Filament Current .....	200 Ma

**DIRECT INTERELECTRODE CAPACITANCES**

Plate to Filament and Internal Shield (Approx.) .....	1.6 Pf
---	--------

**RATINGS (Design Maximum Rating System)**

**Pulse Rectifier Service<sup>(5)</sup>**

Peak Inverse Plate Voltage	
Total DC and Peak (Max.) .....	26,000 Volts
DC (Max.).....	22,000 Volts
Peak Plate Current (Max.) .....	50 Ma
Average Plate Current (Max.).....	0.5 Ma

**CHARACTERISTICS AND TYPICAL OPERATION**

Tube Voltage Drop for Ib = 7 Ma (Approx.) .....	225 Volts
---	-----------

**NOTES:**

- (1) Bases B6-8 and B6-60, Pins 4 and 6 removed.
- (2) Socket terminals 1, 3, 4, 5, 6, and 8 may be connected to terminal 7 or to a corona shield which connects to terminal 7. Terminals 4 and 6 may be used as tie points for components at or near filament potential.
- (3) Outline 9-53 applies with Short Intermediate Shell Octal Base (B6-60). Outline 9-54 applies with Intermediate Shell Octal Base (B6-8).
- (4) Under no circumstances should the filament voltage be less than 1.05 volts or more than 1.45 volts.
- (5) For operation in a 525-line, 30-frame system as described in "Standards of Good Engineering Practice for Television Broadcast Stations; Federal Communications Commission," the duty cycle of the voltage pulse must not exceed 15% of one horizontal scanning cycle.

**X-RADIATION WARNING:** The high voltages associated with this tube type result in the production of X-radiation which may constitute a health hazard on prolonged exposure at close range unless the tube is adequately shielded. Precautions must be exercised during the servicing of equipment to assure that all shielding components are replaced to their intended positions before the equipment is operated.



**Filamentary Diode**

Construction .....	Miniature T-6½
Base .....	Small Button 9 Pin, E9-1
Basing <sup>(1)</sup> .....	.9U
Outline .....	.6-2
Maximum Diameter .....	0.875 In.
Maximum Seated Height .....	1.937 In.
Maximum Overall Height .....	2.187 In.

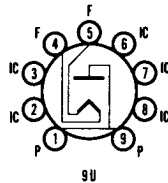

**ELECTRICAL DATA**

**FILAMENT OPERATION**

Filament Voltage <sup>(2)</sup> .....	0.625 Volts
Filament Current .....	300 Ma

**DIRECT INTERELECTRODE CAPACITANCES**

Plate to Filament (Approx.) .....	0.8 Pf
-----------------------------------	--------

**RATINGS (Design Maximum Rating System)**

**Pulse Rectifier Service<sup>(3)</sup>**

Peak Inverse Plate Voltage	
Total DC and Peak (Max.) .....	8250 Volts
DC (Max.).....	7000 Volts
Peak Plate Current (Max.) .....	11 Ma
Average Plate Current (Max.).....	0.6 Ma

**CHARACTERISTICS AND TYPICAL OPERATION**

Tube Voltage Drop for Ib = 7 Ma (Approx.) .....	135 Volts
---	-----------

**NOTES:**

- (1) Socket terminals 2, 3, 7, and 8 shall not be used. Terminal 6 may be used as a tie point for components at or near filament potential.
- (2) Under no circumstances should the filament voltage be less than 0.525 volts or more than 0.725 volts.
- (3) For operation in a 525-line, 30-frame system as described in "Standards of Good Engineering Practice for Television Broadcast Stations; Federal Communications Commission," the duty cycle of the voltage pulse must not exceed 15% of one horizontal scanning cycle.

Color Television Type  
**HIGH VOLTAGE RECTIFIER**

**1X2B**

**Filamentary Diode**

Construction ..... Miniature T-6½  
 Base ..... Button 9 Pin, E9-1  
 Top Cap ..... Skirted Miniature C1-2 or C1-33  
 Basing<sup>(1)</sup> ..... 9Y  
 Outline  
 Maximum Diameter ..... 0.875 In.  
 Maximum Seated Height ..... 2.563 In.  
 Maximum Overall Height ..... 2.844 In.

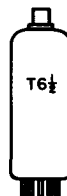
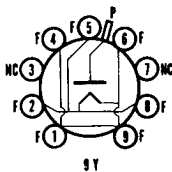

**ELECTRICAL DATA**

**FILAMENT OPERATION**

Filament Voltage ..... 1.25 Volts  
 Filament Current ..... 200 Ma

**DIRECT INTERELECTRODE CAPACITANCES**

Plate to Filament and Internal Shield ..... 1.0 Pf

**RATINGS (Design Maximum Rating System)**

**Pulse Rectifier Service<sup>(2)</sup>**

Peak Inverse Plate Voltage  
 Total DC and Peak (Max.) ..... 22,000 Volts  
 DC (Max.) ..... 18,000 Volts  
 Peak Plate Current (Max.) ..... 45 Ma  
 Average Plate Current (Max.) ..... 0.5 Ma

**CHARACTERISTICS AND TYPICAL OPERATION**

Positive Peak Plate Voltage ..... 18,000 Volts  
 Negative Peak Plate Voltage ..... 2000 Volts  
 DC Output Voltage (Approx.) ..... 18,000 Volts  
 DC Output Current (Approx.) ..... 100 µa  
 Peak Plate Current ..... 35 Ma  
 Tube Voltage Drop With I<sub>b</sub> = 7 Ma (Approx.) ..... 100 Volts

**NOTES:**

- (1) Pins 3 and 7 can be used as a tie point for the filament dropping resistor and high voltage resistor. Do not connect to the low voltage circuits.
- (2) For operation in a 525 line, 30 frame system as described in "Standards of Good Engineering Practice for Television Broadcast Stations; Federal Communications Commission," the duty cycle of the voltage pulse must not exceed 15% of one horizontal scanning cycle.

**X-RADIATION WARNING:** The high voltages associated with this tube type result in the production of X-radiation which may constitute a health hazard on prolonged exposure at close range unless the tube is adequately shielded. Precautions must be exercised during the servicing of equipment to assure that all shielding components are replaced to their intended positions before the equipment is operated.

**HIGH VOLTAGE RECTIFIER**

**2AH2**

**Heater-Cathode Diode**

Construction ..... Compactron T-9  
 Base ..... Button 12 Pin, E12-70  
 Top Cap ..... Small, C1-34  
 Basing<sup>(1,2)</sup> ..... 12DG  
 Outline  
 Maximum Diameter ..... 1.188 In.  
 Maximum Seated Height ..... 3.000 In.  
 Maximum Overall Height ..... 3.375 In.

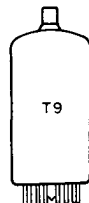
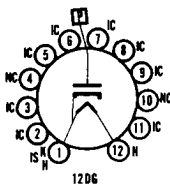

**ELECTRICAL DATA**

**HEATER OPERATION**

Heater Voltage<sup>(3)</sup> ..... 2.5 Volts  
 Heater Current ..... 300 Ma

**DIRECT INTERELECTRODE CAPACITANCES**

Plate to Heater, Cathode, and Internal Shield (Approx.)..... 1.4 Pf

**RATINGS (Design Maximum Rating System)****Pulse Rectifier Service<sup>(4)</sup>**

Peak Inverse Plate Voltage

Total DC and Peak (Max.) ..... 30,000 Volts

DC (Max.)..... 24,000 Volts

Peak Plate Current (Max.) ..... 80 Ma

Average Plate Current (Max.)..... 1.5 Ma

**CHARACTERISTICS AND TYPICAL OPERATION**Tube Voltage Drop for  $I_b = 7$  Ma ..... 100 Volts**NOTES:**

- (1) Pins designated Internal Connection (IC) may or may not have connections to internal elements depending on manufacturer. To maintain interchangeability do not use these pins for external connections.
- (2) Pins 4 and 10 may be used as tie points for components at or near filament potential.
- (3) Under no circumstances should voltage fall below 2.1 volts or exceed 2.9 volts.
- (4) For operation in a 525 line, 30 frame system as described in "Standards of Good Engineering Practice for Television Broadcast Stations; Federal Communications Commission," the duty cycle of the voltage pulse must not exceed 15% of one horizontal scanning cycle.

**X-RADIATION WARNING:** The high voltages associated with this tube type result in the production of X-radiation which may constitute a health hazard on prolonged exposure at close range unless the tube is adequately shielded. Precautions must be exercised during the servicing of equipment to assure that all shielding components are replaced to their intended positions before the equipment is operated.

**2AV2**

Color Television Type

**HIGH VOLTAGE RECTIFIER****Filamentary Diode**

Construction ..... Miniature T-6½

Base ..... Button 9 Pin, E9-1

Basing<sup>(1)</sup> ..... 9U

Outline ..... 6-2

Maximum Diameter ..... 0.875 In.

Maximum Seated Height ..... 1.938 In.

Maximum Overall Height ..... 2.188 In.

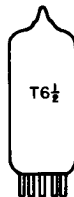
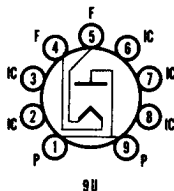
**ELECTRICAL DATA****FILAMENT OPERATION**Filament Voltage<sup>(2)</sup>..... 1.8 Volts

Filament Current ..... 225 Ma

**DIRECT INTERELECTRODE CAPACITANCES**

Plate to Filament ..... 0.8 Pf

**RATINGS (Design Maximum Rating System)****Pulse Rectifier Service<sup>(3)</sup>**

Peak Inverse Plate Voltage

Total DC and Peak (Max.) ..... 8250 Volts

DC (Max.)..... 7000 Volts

Peak Plate Current (Max.) ..... 50 Ma

Average Plate Current (Max.)..... 0.6 Ma

**CHARACTERISTICS AND TYPICAL OPERATION**Tube Voltage Drop for  $I_b = 1$  Ma ..... 20 Volts**NOTES:**

- (1) Socket terminals 2, 3, 7, and 8 shall not be used. Terminal 6 may be used as a tie point for components at or near filament potential.
- (2) Under no circumstances should the filament voltage be less than 1.53 volts or more than 2.07 volts.
- (3) For operation in a 525-line, 30-frame system as described in "Standards of Good Engineering Practice for Television Broadcast Stations; Federal Communications Commission," the duty cycle of the voltage pulse must not exceed 15% of one horizontal scanning cycle.

# HIGH VOLTAGE RECTIFIER

# 2BU2/2AS2A

**Heater-Cathode Diode**

Construction..... Compactron T-9  
 Base ..... Button 12 Pin, E12-70  
 Top Cap ..... Small, C1-34  
 Basing<sup>(1),(4)</sup> ..... 12EW  
 Outline ..... 9-100  
 Maximum Diameter ..... 1.188 In.  
 Maximum Seated Height ..... 3.250 In.  
 Maximum Overall Height ..... 3.625 In.

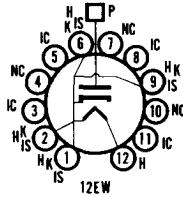

**ELECTRICAL DATA**

**HEATER OPERATION**

Heater Voltage<sup>(2)</sup> ..... 2.5 Volts  
 Heater Current ..... 330 Ma

**DIRECT INTERELECTRODE CAPACITANCES**

Plate to Heater, Cathode, and Internal Shield ..... 1.4 Pf

**RATINGS (Design Maximum Rating System)**

**Pulse Rectifier Service<sup>(3)</sup>**

Peak Inverse Plate Voltage (Max.) ..... 30,000 Volts  
 Peak Plate Current (Max.) ..... 90 Ma  
 Average Plate Current (Max.) ..... 1.7 Ma

**CHARACTERISTICS AND TYPICAL OPERATION**

Tube Voltage Drop for Ib = 7 Ma ..... 75 Volts

**X-RADIATION CHARACTERISTIC**

Maximum X-Radiation ..... 25.0 mR/h

X-Radiation is measured in accordance with JEDEC Publication No. 67, "Recommended Practice for Measurement of X-Radiation from Receiving Tubes," dated February 1968 and quality controlled in accordance with JEDEC Publication No. 73, "Recommended Practice for Quality Control of X-Radiation Emitted from High Voltage Rectifier and Shunt Regulator Receiving Tubes."

Lot acceptance sampling procedures for the manufacturer's initial and life tests for X-Radiation are based on MIL-STD-105, "Military Standard Sampling Procedures and Tables for Inspection by Attributes." Lot acceptance and life control limits are established substantially below the X-Radiation Characteristic Maximum.

**NOTES:**

- (1) Pins designated Internal Connection (IC) may or may not have connections to internal elements depending on manufacturer. To maintain interchangeability do not use these pins for external connections.
- (2) Under no circumstances should voltage fall below 2.1 volts or exceed 2.9 volts.
- (3) For operation in a 525 line, 30 frame system as described in "Standards of Good Engineering Practice for Television Broadcast Stations; Federal Communications Commission," the duty cycle of the voltage pulse must not exceed 15% of one horizontal scanning cycle.
- (4) Pins 4, 7 and 10 may be used as tie points for components at or near heater potential.

**X-RADIATION WARNING:** The high voltages associated with this tube type result in the production of X-radiation which may constitute a health hazard on prolonged exposure at close range unless the tube is adequately shielded. Precautions must be exercised during the servicing of equipment to assure that all shielding components are replaced to their intended positions before the equipment is operated.

*Color Television Type*

# HIGH VOLTAGE RECTIFIER

# 3A2

**Heater-Cathode Diode**

Construction ..... Miniature T-6½  
 Base ..... Button 9 Pin, E9-1  
 Top Cap ..... Skirted Miniature C1-2  
 Basing ..... 9DT  
 Outline ..... 6-7  
 Maximum Diameter ..... 0.875 In.  
 Maximum Seated Height ..... 2.437 In.  
 Maximum Overall Height ..... 2.844 In.

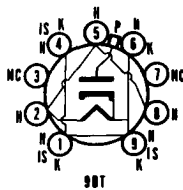

**ELECTRICAL DATA**

**HEATER OPERATION**

Heater Voltage <sup>(1)</sup> .....	3.15 Volts
Heater Current .....	220 Ma

**DIRECT INTERELECTRODE CAPACITANCES**

Plate to Heater, Cathode, and Internal Shield .....	1.0 Pf
---	--------

**RATINGS (Design Maximum Rating System)**

**Pulse Rectifier Service<sup>(2)</sup>**

Peak Inverse Plate Voltage (Max.) .....	18,000 Volts
Peak Plate Current (Max.) .....	80 Ma
Average Plate Current (Max.).....	1.5 Ma

**NOTES:**

- (1) Under no circumstance should voltage fall below 2.65 volts or exceed 3.65 volts.
- (2) For operation in a 525 line, 30 frame system as described in "Standards of Good Engineering Practice for Television Broadcast Stations; Federal Communications Commission," the duty cycle of the voltage pulse must not exceed 15% of one horizontal scanning cycle.

**X-RADIATION WARNING:** The high voltages associated with this tube type result in the production of X-radiation which may constitute a health hazard on prolonged exposure at close range unless the tube is adequately shielded. Precautions must be exercised during the servicing of equipment to assure that all shielding components are replaced to their intended positions before the equipment is operated.



**Heater-Cathode Diode**

Construction .....	Octal T-9
Base .....	Octal 6 Pin, B6-8 or B6-60
Top Cap .....	Small, C1-1 or C1-34
Basing .....	.8EZ
Outline	

Maximum Diameter .....	1.281 In.
Maximum Seated Height .....	3.250 In.
Maximum Overall Height .....	3.812 In.

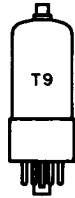
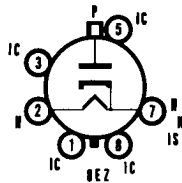

**ELECTRICAL DATA**

**HEATER OPERATION**

Heater Voltage <sup>(1)</sup> .....	3.15 Volts
Heater Current .....	220 Ma

**DIRECT INTERELECTRODE CAPACITANCES**

Plate to Heater, Cathode, and Internal Shield.....	1.5 Pf
--	--------

**RATINGS (Design Maximum Rating System)**

**Pulse Rectifier Service<sup>(2)</sup>**

Peak Inverse Plate Voltage (Max.) .....	30,000 Volts
Peak Plate Current (Max.) .....	100 Ma
Average Plate Current (Max.) .....	2 Ma

**CHARACTERISTICS AND TYPICAL OPERATION**

Tube Voltage Drop for $I_b = 7$ Ma .....	100 Volts
--	-----------

**X-RADIATION CHARACTERISTIC**

Maximum X-Radiation .....	25.0 mR/h
---------------------------	-----------

X-Radiation is measured in accordance with JEDEC Publication No. 67, "Recommended Practice for Measurement of X-Radiation from Receiving Tubes," dated February 1968 and quality controlled in accordance with JEDEC Publication No. 73, "Recommended Practice for Quality Control of X-Radiation Emitted from High Voltage Rectifier and Shunt Regulator Receiving Tubes."

Lot acceptance sampling procedures for the manufacturer's initial and life tests for X-Radiation are based on MIL-STD-105, "Military Standard Sampling Procedures and Tables for Inspection by Attributes." Lot acceptance and life control limits are established substantially below the X-Radiation Characteristic Maximum.

**NOTES:**

- (1) Under no circumstance should voltage fall below 2.65 volts or exceed 3.65 volts.
- (2) For operation in a 525 line, 30 frame system as described in "Standard of Good Engineering Practice for Television Broadcast Stations; Federal Communications Commission," the duty cycle of the voltage pulse must not exceed 15% of one horizontal scanning cycle.

**X-RADIATION WARNING:** The high voltages associated with this tube type result in the production of X-radiation which may constitute a health hazard on prolonged exposure at close range unless the tube is adequately shielded. Precautions must be exercised during the servicing of equipment to assure that all shielding components are replaced to their intended positions before the equipment is operated.

*Color Television Type*  
**HIGH VOLTAGE RECTIFIER**

**3AT2A**

**Heater-Cathode Diode**

Construction..... Compactron T-9  
 Base ..... Button 12 Pin, E12-70  
 Top Cap ..... Small, C1-34  
 Basing ..... 12FV  
 Outline ..... 9-100  
 Maximum Diameter ..... 1.188 In.  
 Maximum Seated Height ..... 3.250 In.  
 Maximum Overall Height ..... 3.625 In.

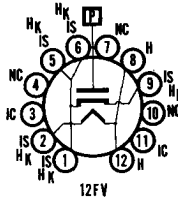

**ELECTRICAL DATA**

**HEATER OPERATION**

Heater Voltage<sup>(1)</sup>..... 3.15 Volts  
 Heater Current ..... 220 Ma

**DIRECT INTERELECTRODE CAPACITANCES**

Plate to Heater, Cathode, and Internal Shield..... 1.5 Pf

**RATINGS (Design Maximum Rating System)**

**Pulse Rectifier Service<sup>(2)</sup>**

Peak Inverse Plate Voltage (Max.) ..... 30,000 Volts  
 Peak Plate Current (Max.) ..... 88 Ma  
 Average Plate Current (Max.)..... 1.7 Ma

**X-RADIATION CHARACTERISTIC**

Maximum X-Radiation ..... 25.0 mR/h

X-Radiation is measured in accordance with JEDEC Publication No. 67, "Recommended Practice for Measurement of X-Radiation from Receiving Tubes," dated February 1968 and quality controlled in accordance with JEDEC Publication No. 73, "Recommended Practice for Quality Control of X-Radiation Emitted from High Voltage Rectifier and Shunt Regulator Receiving Tubes."

Lot acceptance sampling procedures for the manufacturer's initial and life tests for X-Radiation are based on MIL-STD-105, "Military Standard Sampling Procedures and Tables for Inspection by Attributes." Lot acceptance and life control limits are established substantially below the X-Radiation Characteristic Maximum.

**NOTES:**

- (1) Under no circumstance should voltage fall below 2.65 volts or exceed 3.65 volts.
- (2) For operation in a 525 line, 30 frame system as described in "Standards of Good Engineering Practice for Television Broadcast Stations; Federal Communications Commission," the duty cycle of the voltage pulse must not exceed 15% of one horizontal scanning cycle.

**X-RADIATION WARNING:** The high voltages associated with this tube type result in the production of X-radiation which may constitute a health hazard on prolonged exposure at close range unless the tube is adequately shielded. Precautions must be exercised during the servicing of equipment to assure that all shielding components are replaced to their intended positions before the equipment is operated.

*Color Television Type*  
**HIGH VOLTAGE RECTIFIER**

**3AW2A**

**Heater-Cathode Diode**

Construction..... Compactron T-9  
 Base ..... Button 12 Pin, E12-70  
 Top Cap ..... Small, C1-34  
 Basing ..... 12HA  
 Outline ..... 9-100  
 Maximum Diameter ..... 1.188 In.  
 Maximum Seated Height ..... 3.250 In.  
 Maximum Overall Height ..... 3.625 In.

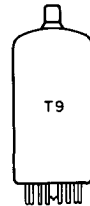
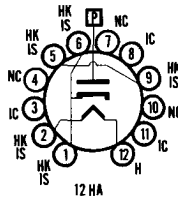

**ELECTRICAL DATA**

**HEATER OPERATION**

Heater Voltage<sup>(1)</sup>..... 3.15 Volts  
 Heater Current ..... 350 Ma

**DIRECT INTERELECTRODE CAPACITANCES**

Plate to Heater, Cathode, and Internal Shield..... 1.6 Pf

**RATINGS (Design Maximum Rating System)**

**Pulse Rectifier Service<sup>(2)</sup>**

Peak Inverse Plate Voltage ..... 38,000 Volts  
 Total DC and Peak (Max.) ..... 30,000 Volts  
 DC (Max.) ..... 110 Ma  
 Peak Plate Current (Max.) ..... 2.2 Ma  
 Average Plate Current (Max.) ..... 2.2 Ma

**CHARACTERISTICS AND TYPICAL OPERATION**

Tube Voltage Drop for  $I_b = 7$  Ma ..... 60 Volts

**X-RADIATION CHARACTERISTIC**

Maximum X-Radiation ..... 25.0 mR/h  
 X-Radiation is measured in accordance with JEDEC Publication No. 67, "Recommended Practice for Measurement of X-Radiation from Receiving Tubes," dated February 1968 and quality controlled in accordance with JEDEC Publication No. 73, "Recommended Practice for Quality Control of X-Radiation Emitted from High Voltage Rectifier and Shunt Regulator Receiving Tubes."

Lot acceptance sampling procedures for the manufacturer's initial and life tests for X-Radiation are based on MIL-STD-105, "Military Standard Sampling Procedures and Tables for Inspection by Attributes." Lot acceptance and life control limits are established substantially below the X-Radiation Characteristic Maximum.

**NOTES:**

- (1) Under no circumstance should voltage fall below 2.65 volts or exceed 3.65 volts.
- (2) For operation in a 525 line, 30 frame system as described in "Standards of Good Engineering Practice for Television Broadcast Stations; Federal Communications Commission," the duty cycle of the voltage pulse must not exceed 15% of one horizontal scanning cycle.

**X-RADIATION WARNING:** The high voltages associated with this tube type result in the production of X-radiation which may constitute a health hazard on prolonged exposure at close range unless the tube is adequately shielded. Precautions must be exercised during the servicing of equipment to assure that all shielding components are replaced to their intended positions before the equipment is operated.



**Filamentary Diode**

Construction..... Compactron T-9  
 Base ..... Button 12 Pin, E12-70  
 Top Cap ..... Small, C1-34  
 Basing<sup>(1,2,3,4)</sup> ..... 12HK  
 Outline ..... 9-100  
 Maximum Diameter ..... 1.188 In.  
 Maximum Seated Height ..... 3.250 In.  
 Maximum Overall Height ..... 3.625 In.

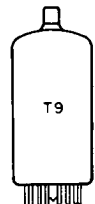
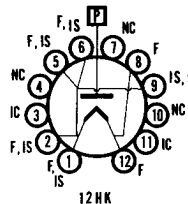

**ELECTRICAL DATA**

**FILAMENT OPERATION**

Filament Voltage<sup>(5)</sup> ..... 3.3 Volts  
 Filament Current ..... 285 Ma

**DIRECT INTERELECTRODE CAPACITANCES**

Plate to Filament and Internal Shield..... 1.5 Pf

**RATINGS (Design Maximum Rating System)**

**Pulse Rectifier Service<sup>(6)</sup>**

Peak Inverse Plate Voltage (Max.) ..... 33,000 Volts  
 Peak Plate Current (Max.) ..... 100 Ma  
 Average Plate Current (Max.) ..... 2.0 Ma

**CHARACTERISTICS AND TYPICAL OPERATION**

Tube Voltage Drop for  $I_b = 7$  Ma ..... 50 Volts

**X-RADIATION CHARACTERISTIC**

Maximum X-Radiation ..... 25.0 mR/h  
 X-Radiation is measured in accordance with JEDEC Publication No. 67, "Recommended Practice for Measurement of X-Radiation from Receiving Tubes," dated February 1968 and quality controlled in accordance with JEDEC Publication No. 73, "Recommended Practice for Quality Control of X-Radiation Emitted from High Voltage Rectifier and Shunt Regulator Receiving Tubes."

Lot acceptance sampling procedures for the manufacturer's initial and life tests for X-Radiation are based on MIL-STD-105, "Military Standard Sampling Procedures and Tables for Inspection by Attributes." Lot acceptance and life control limits are established substantially below the X-Radiation Characteristic Maximum.



**NOTES:**

- (1) Pins designated Internal Connection (IC) may or may not have connections to internal elements depending on the manufacturer. To maintain interchangeability do not use these pins for external connection.
- (2) Use Pin No. 4 as tie point for series resistor in 2nd anode lead for the picture tube.
- (3) Use Pin No. 10 as tie point for series filament resistor.
- (4) Either Pins 1, 2, 5, 6, or 9—use as high voltage output connection.
- (5) Under no circumstance should voltage fall below 3.02 or exceed 4.18 volts.
- (6) For operation in a 525 line, 30 frame system as described in "Standards of Good Engineering Practice for Television Broadcast Stations; Federal Communications Commission," the duty cycle of the voltage pulse must not exceed 15% of one horizontal scanning cycle.

**X-RADIATION WARNING:** The high voltages associated with this tube type result in the production of X-radiation which may constitute a health hazard on prolonged exposure at close range unless the tube is adequately shielded. Precautions must be exercised during the servicing of equipment to assure that all shielding components are replaced to their intended positions before the equipment is operated.

*Color Television Type*

**HIGH VOLTAGE RECTIFIER  
POSTED FILAMENT DESIGN**

**3BM2A**

**Filamentary Diode**

Construction.....Compactron T-9  
 Base ..... Button 12-Pin, E12-70  
 Top Cap ..... Small, C1-34  
 Basing<sup>(1,2,3,4)</sup> ..... 12HK  
 Outline ..... 9-100  
 Maximum Diameter ..... 1.188 In.  
 Maximum Seated Height ..... 3.250 In.  
 Maximum Overall Height ..... 3.625 In.

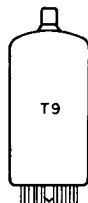
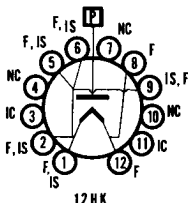

**ELECTRICAL DATA**

**FILAMENT OPERATION**

Filament Voltage<sup>(5)</sup>..... 3.0 Volts  
 Filament Current ..... 300 Ma

**DIRECT INTERELECTRODE CAPACITANCES**

Plate to Filament and Internal Shield..... 1.5 Pf

**RATINGS (Design Maximum Rating System)**

**Pulse Rectifier Service<sup>(6)</sup>**  
 Peak Inverse Plate Voltage (Max.) ..... 33,000 Volts  
 Peak Plate Current (Max.) ..... 100 Ma  
 Average Plate Current (Max.)..... 2.0 Ma

**CHARACTERISTICS AND TYPICAL OPERATION**

Tube Voltage Drop for I<sub>b</sub> = 7 Ma ..... 50 Volts

**X-RADIATION CHARACTERISTIC**

Maximum X-Radiation ..... 25.0 mR/h

X-Radiation is measured in accordance with JEDEC Publication No. 67, "Recommended Practice for Measurement of X-Radiation from Receiving Tubes," dated February 1968 and quality controlled in accordance with JEDEC Publication No. 73, "Recommended Practice for Quality Control of X-Radiation Emitted from High Voltage Rectifier and Shunt Regulator Receiving Tubes."

Lot acceptance sampling procedures for the manufacturer's initial and life tests for X-Radiation are based on MIL-STD-105, "Military Standard Sampling Procedures and Tables for Inspection by Attributes." Lot acceptance and life control limits are established substantially below the X-Radiation Characteristic Maximum.

**NOTES:**

- (1) Pins designated Internal Connection (IC) may or may not have connections to internal elements depending on the manufacturer. To maintain interchangeability do not use these pins for external connection.
- (2) Use Pin No. 4 as tie point for series resistor in 2nd anode lead for the picture tube.
- (3) Use Pin No. 10 as tie point for series filament resistor.
- (4) Either Pins 1, 2, 5, 6, or 9—use as high voltage output connection.
- (5) Under no circumstance should voltage fall below 2.5 or exceed 3.5 volts.
- (6) For operation in a 525 line, 30 frame system as described in "Standards of Good Engineering Practice for Television Broadcast Stations; Federal Communications Commission," the duty cycle of the voltage pulse must not exceed 15% of one horizontal scanning cycle.

**X-RADIATION WARNING:** The high voltages associated with this tube type result in the production of X-radiation which may constitute a health hazard on prolonged exposure at close range unless the tube is adequately shielded. Precautions must be exercised during the servicing of equipment to assure that all shielding components are replaced to their intended positions before the equipment is operated.

**3BN2A**

Color Television Type  
**HIGH VOLTAGE RECTIFIER**

**Heater-Cathode Diode**

Construction..... Compactron T-9  
 Base ..... Button 12 Pin, E12-70  
 Top Cap ..... Small, C1-34  
 Basing..... 12FV  
 Outline ..... 9-100  
 Maximum Diameter ..... 1.188 In.  
 Maximum Seated Height ..... 3.250 In.  
 Maximum Overall Height ..... 3.625 In.

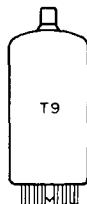
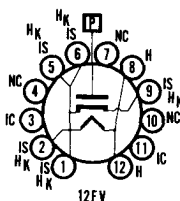
**ELECTRICAL DATA****HEATER OPERATION**

Heater Voltage<sup>(1)</sup>..... 3.15 Volts  
 Heater Current ..... 300 Ma  
 Operational Warm-up Time ..... 4 Sec.

**DIRECT INTERELECTRODE CAPACITANCES**

Plate to Heater, Cathode, and Internal Shield ..... 1.5 Pf

**RATINGS (Design Maximum Rating System)****Pulse Rectifier Service<sup>(2)</sup>**

Peak Inverse Plate Voltage  
 Total DC and Peak (Max.) ..... 30,000 Volts  
 DC (Max.)..... 27,000 Volts  
 Peak Plate Current (Max.) ..... 88 Ma  
 Average Plate Current (Max.) ..... 1.7 Ma

**CHARACTERISTICS AND TYPICAL OPERATION**

Tube Voltage Drop for  $I_b = 7$  Ma ..... 150 Volts

**X-RADIATION CHARACTERISTIC**

Maximum X-Radiation ..... 25.0 mR/h

X-Radiation is measured in accordance with JEDEC Publication No. 67, "Recommended Practice for Measurement of X-Radiation from Receiving Tubes," dated February 1968 and quality controlled in accordance with JEDEC Publication No. 73, "Recommended Practice for Quality Control of X-Radiation Emitted from High Voltage Rectifier and Shunt Regulator Receiving Tubes."

Lot acceptance sampling procedures for the manufacturer's initial and life tests for X-Radiation are based on MIL-STD-105, "Military Standard Sampling Procedures and Tables for Inspection by Attributes." Lot acceptance and life control limits are established substantially below the X-Radiation Characteristic Maximum.

**NOTES:**

- (1) Under no circumstance should voltage fall below 2.65 or exceed 3.65 volts.
- (2) For operation in a 525 line, 30 frame system as described in "Standards of Good Engineering Practice for Television Broadcast Stations; Federal Communications Commission," the duty cycle of the voltage pulse must not exceed 15% of one horizontal scanning cycle.

**X-RADIATION WARNING:** The high voltages associated with this tube type result in the production of X-radiation which may constitute a health hazard on prolonged exposure at close range unless the tube is adequately shielded. Precautions must be exercised during the servicing of equipment to assure that all shielding components are replaced to their intended positions before the equipment is operated.

**3BS2A**

Color Television Type  
**HIGH VOLTAGE RECTIFIER**

**Heater-Cathode Diode**

Construction..... Compactron T-9  
 Base ..... E12-70  
 Top Cap ..... Small C1-34  
 Basing<sup>(2)</sup> ..... 12HY  
 Outline ..... 9-100  
 Maximum Diameter ..... 1.188 In.  
 Maximum Seated Height ..... 3.250 In.  
 Maximum Overall Height ..... 3.625 In.

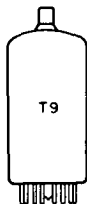
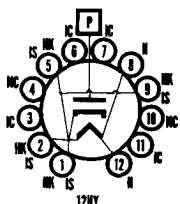

**ELECTRICAL DATA  
HEATER OPERATION**

Heater Voltage.....	3.15 Volts
Heater Current .....	480 Ma
Heater Warm-up Time .....	4 Seconds

**DIRECT INTERELECTRODE CAPACITANCES**

Plate to Heater, Cathode and Internal Shield .....	<b>Without Shield</b>
	1.6 pf

**RATINGS (Design Maximum Rating System)**

**Pulse Rectifier Service<sup>(1)</sup>**

Peak Inverse Plate Voltage	
Total DC and Peak (Absolute Max.).....	38,000 Volts
DC Component (Absolute Max.) .....	30,000 Volts
Steady State Peak Plate Current (Design Max.).....	110 Ma
Average Plate Current (DC Output) (Design Max.).....	2.2 Ma

**AVERAGE CHARACTERISTICS**

Instantaneous Tube Drop (Approx.) for $I_b = 7.0$ Ma .....	60 Volts
--	----------

**NOTES:**

- (1) For operation as a pulsed rectifier in a 525 line, 30 frame system as described in "Standards of Good Engineering Practice for Television Broadcast Stations; Federal Communications Commission," the duty cycle of the voltage pulse must not exceed 15% of one horizontal scanning cycle.
- (2) Pins 4, 7, and 10 may be used as tie points for components at or near heater potential.

**X-RADIATION WARNING:** The high voltages associated with this tube type result in the production of X-radiation which may constitute a health hazard on prolonged exposure at close range unless the tube is adequately shielded. Precautions must be exercised during the servicing of equipment to assure that all shielding components are replaced to their intended positions before the equipment is operated.

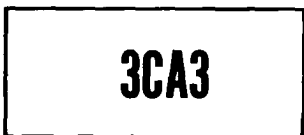

**Heater-Cathode Diode**

Construction .....	Octal T-9
Base.....	Octal 6 Pin, B6-8 or B6-60
Top Cap .....	Small, C1-34
Basing <sup>(1)</sup> .....	8MH

Outline	
Maximum Diameter .....	1.188 In.
Maximum Seated Height .....	3.500 In.
Maximum Overall Height .....	4.063 In.

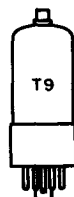
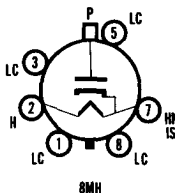

**ELECTRICAL DATA**

**HEATER OPERATION**

Heater Voltage <sup>(2)</sup> .....	3.6 Volts
Heater Current .....	225 Ma

**DIRECT INTERELECTRODE CAPACITANCES**

Plate Heater, Cathode, and Internal Shield .....	1.6 Pf
--	--------

**RATINGS (Design Maximum Rating System)**

**Pulse Rectifier Service<sup>(3)</sup>**

Peak Inverse Plate Voltage (Max.) .....	30,000 Volts
Peak Plate Current (Max.) .....	100 Ma
Average Plate Current (Max.).....	2 Ma

**CHARACTERISTICS AND TYPICAL OPERATION**

Tube Voltage Drop for $I_b = 11$ Ma .....	100 Volts
---	-----------

**NOTES:**

- (1) Socket Pins No. 1, 3, 4, 5, 6, and 8 may be connected to Pin No. 7 or a corona shield which connects to Pin 7. Pins 4 and 6 may be used as tie points at or near cathode potential, otherwise do not use.
- (2) Under no circumstances should voltage fall below 3.02 or exceed 4.18 volts.
- (3) For operation in a 525 line, 30 frame system as described in "Standards of Good Engineering Practice for Television Broadcast Stations; Federal Communications Commission," the duty cycle of the voltage pulse must not exceed 15% of one horizontal scanning cycle.

**X-RADIATION WARNING:** The high voltages associated with this tube type result in the production of X-radiation which may constitute a health hazard on prolonged exposure at close range unless the tube is adequately shielded. Precautions must be exercised during the servicing of equipment to assure that all shielding components are replaced to their intended positions before the equipment is operated.

# 3CN3A

## 2CN3B

Color Television Type

# HIGH VOLTAGE RECTIFIER

### Heater-Cathode Diode

Construction ..... Octal T-9  
 Base ..... Octal 8 Pin, B8-6, B8-42, B8-58  
 or B8-251

Top Cap ..... Small, C1-1 or C1-34

Basing<sup>(1)</sup> ..... 8MU

#### Outline

Maximum Diameter ..... 1.281 In.

Maximum Seated Height ..... 3.250 In.

Maximum Overall Height ..... 3.812 In.

### ELECTRICAL DATA

#### HEATER OPERATION

	2CN3B	3CN3A
Heater Voltage <sup>(2)</sup> .....	1.8	3.15 Volts
Heater Current .....	900	480 Ma

#### DIRECT INTERELECTRODE CAPACITANCES

Plate to Heater, Cathode, and Internal Shield..... 1.6 Pf

#### RATINGS (Design Maximum Rating System)

##### Pulse Rectifier Service<sup>(3)</sup>

Peak Inverse Plate Voltage	
Total DC and Peak (Abs. Max.) .....	38,000 Volts
DC (Abs. Max.) .....	30,000 Volts
Peak Plate Current (Design Max.) .....	110 Ma
Average Plate Current (Design Max.) .....	2.2 Ma

#### CHARACTERISTICS AND TYPICAL OPERATION

Tube Voltage Drop for Ib = 7 Ma ..... 60 Volts

#### 2CN3B Only

#### X-RADIATION CHARACTERISTIC

Maximum X-Radiation ..... 25.0 mR/h

X-Radiation is measured in accordance with JEDEC Publication No. 67, "Recommended Practice for Measurement of X-Radiation from Receiving Tubes," dated February 1968 and quality controlled in accordance with JEDEC Publication No. 73, "Recommended Practice for Quality Control of X-Radiation Emitted from High Voltage Rectifier and Shunt Regulator Receiving Tubes."

Lot acceptance sampling procedures for the manufacturer's initial and life tests for X-Radiation are based on MIL-STD-105, "Military Standard Sampling Procedures and Tables for Inspection by Attributes." Lot acceptance and life control limits are established substantially below the X-Radiation Characteristic Maximum.

#### NOTES:

- (1) Socket Pins No. 1, 3, 5, and 8 may be connected to Pin No. 7 or a corona shield which connects to Pin No. 7, otherwise do not use.
- (2) Under no circumstances should voltage fall below 2.65 or exceed 3.65 volts (3CN3A only).
- (3) For operation in a 525 line, 30 frame system as described in "Standards of Good Engineering Practice for Television Broadcast Stations; Federal Communications Commission," the duty cycle of the voltage pulse must not exceed 15% of one horizontal scanning cycle.

**X-RADIATION WARNING:** The high voltages associated with this tube type result in the production of X-radiation which may constitute a health hazard on prolonged exposure at close range unless the tube is adequately shielded. Precautions must be exercised during the servicing of equipment to assure that all shielding components are replaced to their intended positions before the equipment is operated.

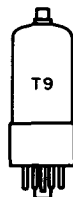
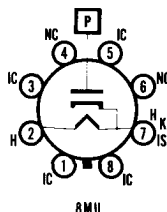

# 3CU3A

Color Television Type

# HIGH VOLTAGE RECTIFIER

### Filamentary Diode

Construction ..... Octal T-9

Base.... B6-8, B6-48, B6-60, B8-251 or B6-253

Top Cap ..... C1-34 or C1-50

Basing<sup>(1), (2), (3)</sup> ..... 8MK

#### Outline

Maximum Diameter ..... 1.281 In.

Maximum Seated Height ..... 3.250 In.

Maximum Overall Height ..... 3.812 In.

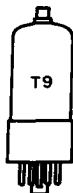
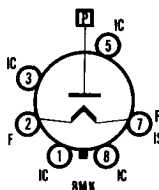

**ELECTRICAL DATA**

**FILAMENT OPERATION**

Filament Voltage.....	3.15 Volts
Filament Current .....	280 Ma

**DIRECT INTERELECTRODE CAPACITANCES**

Plate to Filament and Internal Shield.....	<b>Without Shield</b> 1.5 pf
--	---------------------------------

**RATINGS (Design Maximum Rating System)**

**Pulse Rectifier Service<sup>(4)</sup>**

Peak Inverse Plate Voltage	
Total DC and Peak (Absolute Max.).....	38,000 Volts
DC Component (Absolute Max.) .....	30,000 Volts
Steady State Peak Plate Current (Design Max.).....	100 Ma
Average Plate Current (DC Output) (Design Max.) .....	2.0 Ma

**AVERAGE CHARACTERISTICS**

Instantaneous Tube Drop (Approx.) for $I_b = 7.0$ Ma .....	50 Volts
--	----------

**X-RADIATION CHARACTERISTIC**

Maximum X-Radiation ..... 25.0 mR/h  
 X-Radiation is measured in accordance with JEDEC Publication No. 67, "Recommended Practice for Measurement of X-Radiation from Receiving Tubes," dated February 1968 and quality controlled in accordance with JEDEC Publication No. 73, "Recommended Practice for Quality Control of X-Radiation Emitted from High Voltage Rectifier and Shunt Regulator Receiving Tubes."

Lot acceptance sampling procedures for the manufacturer's initial and life tests for X-Radiation are based on MIL-STD-105, "Military Standard Sampling Procedures and Tables for Inspection by Attributes." Lot acceptance and life control limits are established substantially below the X-Radiation Characteristic Maximum.

**NOTES:**

- (1) Pins designated Internal Connection (IC) may or may not have connections to internal elements depending on manufacturer. To maintain interchangeability do not use these pins for external socket connections.
- (2) Pin connections 4 and 6 may be used as tie points.
- (3) Use Pin 7 as high voltage output connection.
- (4) For operation in a 525 line, 30 frame system as described in "Standards of Good Engineering Practice for Television Broadcast Stations; Federal Communications Commission," the duty cycle of the voltage pulse must not exceed 15% of one horizontal scanning cycle.
- (5) Good high voltage practice dictates that a minimum of 1/2 inch be maintained between the tube envelope and the filament and/or DC output leads.

**X-RADIATION WARNING:** The high voltages associated with this tube type result in the production of X-radiation which may constitute a health hazard on prolonged exposure at close range unless the tube is adequately shielded. Precautions must be exercised during the servicing of equipment to assure that all shielding components are replaced to their intended positions before the equipment is operated.

Color Television Type  
**HIGH VOLTAGE RECTIFIER**

**3DC3**

**Filamentary Diode**

Construction .....	Octal T-9
Base .....	B8-6, B8-58, B8-142, B8-251
Basing <sup>(2), (3)</sup> .....	8MZ
Outline	
Maximum Diameter .....	1.281 In.
Maximum Seated Height .....	3.250 In.
Maximum Overall Height .....	3.812 In.

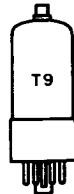
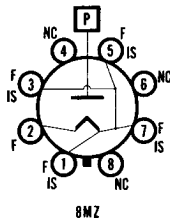

**ELECTRICAL DATA**

**FILAMENT OPERATION**

Filament Voltage.....	3.15 Volts
Filament Current .....	280 Ma

**DIRECT INTERELECTRODE CAPACITANCES**

Plate to Filament and Internal Shield.....	<b>Without Shield</b> 1.5 pf
--	---------------------------------

**RATINGS (Design Maximum Rating System)**

**Pulse Rectifier Service<sup>(4)</sup>**

Peak Inverse Plate Voltage	
Total DC and Peak (Absolute Max.)	38,000 Volts
DC Component (Absolute Max.)	30,000 Volts
Steady State Peak Plate Current (Design Max.)	110 Ma
Average Plate Current (DC Output) (Design Max.)	2.2 Ma

**AVERAGE CHARACTERISTICS**

Instantaneous Tube Drop (Approx.) for $I_b = 7.0$ Ma.	50 Volts
---	----------

**X-RADIATION CHARACTERISTIC**

Maximum X-Radiation ..... 25.0 mR/h  
 X-Radiation is measured in accordance with JEDEC Publication No. 67, "Recommended Practice for Measurement of X-Radiation from Receiving Tubes," dated February 1968 and quality controlled in accordance with JEDEC Publication No. 73, "Recommended Practice for Quality Control of X-Radiation Emitted from High Voltage Rectifier and Shunt Regulator Receiving Tubes."

Lot acceptance sampling procedures for the manufacturer's initial and life tests for X-Radiation are based upon MIL-STD-105, "Military Standard Sampling Procedures and Tables for Inspection by Attributes." Lot acceptance and life control limits are established substantially below the X-Radiation Characteristic Maximum.

**NOTES:**

- (1) Good high voltage practice dictates that a minimum of 1/2 inch be maintained between the tube envelope and the filament and/or DC output leads.
- (2) Socket connections 4, 6 and 8 may be used as tie points.
- (3) Use Pin 7 as high voltage output connection.
- (4) For operation as a pulsed rectifier in a 525 line, 30 frame system as described in "Standards of Good Engineering Practice for Television Broadcast Stations; Federal Communications Commission," the duty cycle of the voltage pulse must not exceed 15% of one horizontal scanning cycle.

**X-RADIATION WARNING:** The high voltages associated with this tube type result in the production of X-radiation which may constitute a health hazard on prolonged exposure at close range unless the tube is adequately shielded. Precautions must be exercised during the servicing of equipment to assure that all shielding components are replaced to their intended positions before the equipment is operated.



**Filamentary Twin Diode**

Construction	Octal T-12
Base	Octal 5 Pin
Basing	.5DE
Outline	.12-16
Maximum Diameter	1.563 In.
Maximum Seated Height	4.063 In.
Maximum Overall Height	4.625 In.

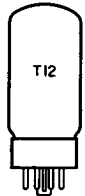
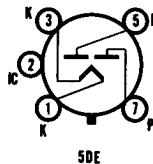

**ELECTRICAL DATA**

**FILAMENT OPERATION**

Filament Voltage	3.3 Volts
Filament Current	3800 Ma

**RATINGS (Design Maximum Rating System)**

**Rectifier Service<sup>(1)</sup>**

Peak Inverse Plate Voltage (Max.)	1050 Volts
AC Plate Supply Voltage (Each Plate, RMS) (Max.)	375 Volts
DC Output Current (Max.)	400 Ma
Steady State Peak Plate Current (Each Plate) (Max.)	1200 Ma
Transient Peak Plate Current (Each Plate) (Max.)	6500 Ma
Bulb Temperature at Hottest Point (Max.)	200 °C

**CHARACTERISTICS AND TYPICAL OPERATION**

**Full Wave Rectifier—Capacitor Input Filter**

AC Plate Supply Voltage (Each Plate, RMS) <sup>(2)</sup>	275 Volts
Filter Input Capacitor	40 μf
Effective Plate-Supply Resistance (Each Plate)	32 Ohms
DC Output Current	350 Ma
DC Output Voltage at Filter Input	300 Volts
Tube Voltage Drop for $I_b = 350$ Ma (Each Plate)	25 Volts

**NOTES:**

- (1) For use with sinusoidal supply voltages within the frequency range of 25 to 1000 Hertz.
- (2) AC plate voltage is measured without load.

RATING CHART (3DG4)

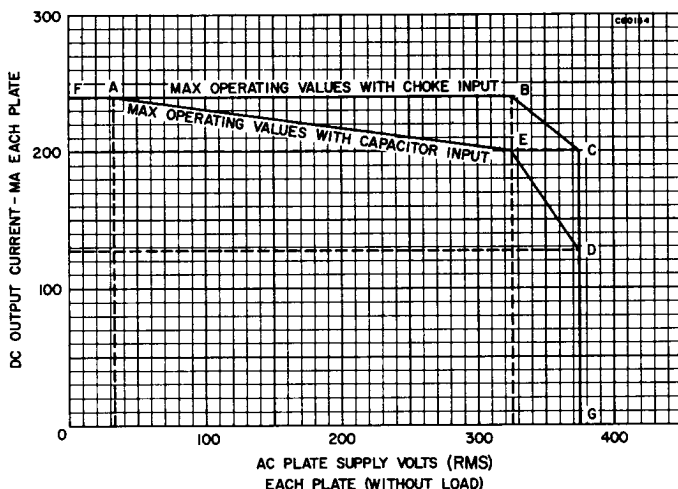

**FULL-WAVE POWER RECTIFIER**

**5AR4/GZ34**

**Heater-Cathode Twin Diode**

- Construction .....Octal T-11
- Base .....Octal 5 Pin
- Basing .....5DA
- Outline
  - Maximum Diameter .....1.313 In.
  - Maximum Seated Height .....2.875 In.
  - Maximum Overall Height .....3.438 In.

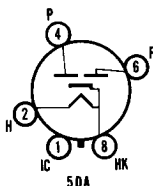

**ELECTRICAL DATA**

**HEATER OPERATION**

- Heater Voltage..... 5.0 Volts
- Heater Current..... 1900 Ma

**RATINGS (Design Center Rating System)**

**Rectifier Service<sup>(1)</sup>**

- Peak Inverse Plate Voltage (Max.) ..... 1500 Volts
- Peak Plate Current (Max.) ..... 750 Ma
- AC Plate Supply Voltage (Each Plate, RMS) (Max.) ..... 550 Volts
- Steady State DC Output Current (Max.)..... 250 Ma
- Condenser Input to Filter (Max.)..... 60  $\mu$ f

**CHARACTERISTICS AND TYPICAL OPERATION**

**Full-Wave Rectifier—Capacitor Input Filter**

AC Plate Supply Voltage (Each Plate, RMS) <sup>(2)</sup>	300	350	400	450	500	550 Volts
DC Output Current.....	250	250	250	250	200	160 Ma
DC Output Voltage.....	330	380	430	480	560	640 Volts
Limiting Resistor (Per Plate).....	75	100	125	150	175	200 Ohms

**Full-Wave Rectifier—Choke Input Filter**

AC Plate Supply Voltage (Each Plate, RMS) <sup>(2)</sup>	300	350	400	450	500	550 Volts
DC Output Current.....	250	250	250	250	250	225 Ma
DC Output Voltage.....	250	290	330	375	420	465 Volts
Limiting Resistor (Per Plate).....	0	0	0	0	0	0 Ohm
Filter Input Choke.....	10	10	10	10	10	10 Henrys

**NOTES:**

- (1) For use with sinusoidal supply voltages within the frequency range of 25 to 1000 Hertz.
- (2) AC plate voltage is measured without load.

**5AS4A****FULL-WAVE POWER RECTIFIER****Filamentary Twin Diode**

Construction .....Octal T-12  
 Base .....B5-121 or B8-118  
 Basing<sup>(1)</sup>.....5T  
 Outline .....12-15  
 Maximum Diameter .....1.563 In.  
 Maximum Seated Height .....3.688 In.  
 Maximum Overall Height .....4.250 In.

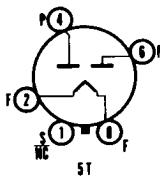
**ELECTRICAL DATA****FILAMENT OPERATION**

Filament Voltage ..... 5.0 Volts  
 Filament Current ..... 3000 Ma

**RATINGS (Design Center Rating System)****Rectifier Service<sup>(2)</sup>**

Peak Inverse Plate Voltage (Max.) ..... 1550 Volts  
 AC Plate Supply Voltage (Each Plate, RMS) (Max.) ..... 550 Volts  
 DC Output Current (Each Plate) (Max.) ..... 87.5 Ma  
 Steady State Peak Plate Current (Each Plate) (Max.) ..... 1000 Ma  
 Transient Peak Plate Current (Each Plate) (Max.) ..... 4600 Ma

**CHARACTERISTICS AND TYPICAL OPERATION****Full-Wave Rectifier—Capacitor Input Filter**

AC Plate Supply Voltage (Each Plate, RMS)<sup>(3)</sup> ..... 300 450 Volts  
 Filter Input Capacitor ..... 40 40  $\mu$ f  
 Effective Plate-Supply Resistance (Each Plate) ..... 21 67 Ohms  
 DC Output Current ..... 300 275 Ma  
 DC Output Voltage at Filter Input ..... 290 460 Volts

**Full-Wave Rectifier—Choke Input Filter**

AC Plate Supply Voltage (Each Plate, RMS)<sup>(3)</sup> ..... 550 Volts  
 Filter Input Choke ..... 10 Henrys  
 DC Output Current ..... 275 Ma  
 DC Output Voltage at Filter Input ..... 420 Volts  
 Tube Voltage Drop for  $I_b = 275$  Ma (Each Plate) ..... 50 Volts  
 300 Ma (Each Plate) ..... 54 Volts

**NOTES:**

- (1) Horizontal Operation is permitted if Pins 1 and 4 are in a vertical plane.
- (2) For use with Sinusoidal supply voltages within the frequency range of 25 to 1000 Hertz.
- (3) AC plate voltage is measured without load.

**5AU4****FULL-WAVE POWER RECTIFIER****Filamentary Twin Diode**

Construction .....Octal T-12  
 Base .....B8-114 or B8-118  
 Basing<sup>(1)</sup>.....5T  
 Outline .....12-26  
 Maximum Diameter .....1.563 In.  
 Maximum Seated Height .....4.063 In.  
 Maximum Overall Height .....4.625 In.

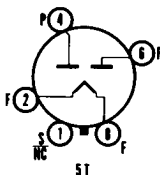
**ELECTRICAL DATA****FILAMENT OPERATION**

Filament Voltage ..... 5.0 Volts  
 Filament Current ..... 3750 Ma

**RATINGS (Design Center Rating System)****Rectifier Service<sup>(2)</sup>**

Peak Inverse Plate Voltage (Max.) ..... 1400 Volts  
 AC Plate Supply Voltage (Each Plate, RMS) (Max.) ..... 500 Volts



DC Output Current (Each Plate) (Max.) .....	105 Ma
Steady State Peak Plate Current (Each Plate) (Max.) .....	1075 Ma
Transient Peak Plate Current (Each Plate) (Max.) <sup>(3)</sup> .....	525 Ma

**CHARACTERISTICS AND TYPICAL OPERATION**

**Full-Wave Rectifier—Capacitor Input Filter**

AC Plate Supply Voltage (Each Plate, RMS) <sup>(4)</sup> .....	300	400 Volts
Filter Input Capacitor .....	40	40 $\mu$ f
Effective Plate Supply Resistance (Each Plate) .....	30	50 Ohms
DC Output Current .....	350	325 Ma
DC Output Voltage at Filter Input .....	275	395 Volts

**Full-Wave Rectifier—Choke Input Filter**

AC Plate Supply Voltage (Each Plate, RMS) <sup>(4)</sup> .....	500 Volts
Filter Input Choke .....	10 Henrys
DC Output Current .....	325 Ma
DC Output Voltage at Filter Input .....	395 Volts
Tube Voltage Drop for $I_b = 350$ Ma Each Plate .....	50 Volts

**NOTES:**

- (1) Horizontal operation is permitted if Pins 2 and 4 are in a vertical plane.
- (2) For use with sinusoidal supply voltages within the frequency range of 25 to 1000 Hertz.
- (3) Maximum duration 0.2 second.
- (4) AC plate voltage is measured without load.

*Color Television Type*

**IF/VIDEO/AGC AMP (Triode)  
OSC/SYNC SEP. (Pentode)**

**5AV8**

**Medium Mu Triode and Sharp Cutoff Pentode**

Construction .....	Miniature T-6½
Base .....	Button 9 Pin
Basing .....	9DZ
Outline .....	6-2
Maximum Diameter .....	0.875 In.
Maximum Seated Height .....	1.937 In.
Maximum Overall Height .....	2.187 In.

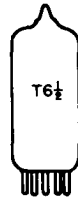
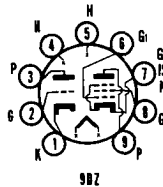

**ELECTRICAL DATA**

**HEATER OPERATION**

Heater Voltage .....	4.7 Volts
Heater Current .....	600 Ma
Heater Warm-up Time .....	11 Seconds
Maximum Heater-Cathode Voltage	
Heater Negative With Respect to Cathode	
Total DC and Peak .....	200 Volts
Heater Positive With Respect to Cathode	
DC .....	100 Volts
Total DC and Peak .....	200 Volts

**DIRECT INTERELECTRODE CAPACITANCES (Unshielded)**

**Triode Section**

Grid to Plate .....	1.5 Pf
Input: g to (h + k) .....	2.0 Pf
Output: p to (h + k) .....	0.34 Pf

**Pentode Section**

Grid No. 1 to Plate (Max.) .....	0.04 Pf
Input: g1 to (h + k + g2 + g3 + I.S.) .....	7.0 Pf
Output: p to (h + k + g2 + g3 + I.S.) .....	3.0 Pf

**Coupling**

Triode Grid to Pentode Plate (Max.) .....	0.02 Pf
Pentode Grid No. 1 to Triode Plate (Max.) .....	0.02 Pf
Pentode Plate to Triode Plate (Max.) .....	0.15 Pf

**RATINGS (Design Maximum Rating System)**

	Triode Section	Pentode Section
Plate Voltage (Max.) .....	330	330 Volts
Grid No. 2 Supply Voltage (Max.) .....	—	330 Volts
Grid No. 2 Voltage .....	See Rating Chart (Gen. Info. Sec.)	
Grid No. 1 Voltage		
Positive Bias Value (Max.) .....	0	0 Volt
Plate Dissipation (Max.) .....	2.8	2.3 Watts

Grid No. 2 Input (Max.) .....	—	0.55 Watts
Grid No. 1 Circuit Resistance <sup>(1)</sup>		
Fixed Bias (Max.) .....	0.5	0.25 Megohms
Cathode Bias (Max.) .....	1.0	1.0 Megohms

**CHARACTERISTICS AND TYPICAL OPERATION**

	<b>Triode Section</b>	<b>Pentode Section</b>
Plate Supply Voltage.....	150	125 Volts
Grid No. 2 Supply Voltage.....	—	125 Volts
Grid No. 1 Voltage .....	-3	— Volts
Cathode Bias Resistor .....	—	56 Ohms
Plate Current .....	15	12 Ma
Grid No. 2 Current .....	—	3.8 Ma
Transconductance .....	4500	7800 $\mu$ mhos
Amplification Factor .....	21	—
Plate Resistance (Approx.) .....	4700	170,000 Ohms
E <sub>c1</sub> for I <sub>b</sub> = 20 $\mu$ a (Approx.).....	-17	-6 Volts
I <sub>b</sub> with E <sub>c1</sub> = -3 Volts, R <sub>K</sub> = 0 .....	—	1.6 Ma

**NOTE:**

(1) If either section is operating at maximum rated conditions, the grid No. 1 circuit resistance for both sections should not exceed the stated values.



**Filamentary Twin Diode**

Construction .....Novar T-12  
 Base .....Large Button 9-Pin, E9-76  
 Basing<sup>(1,2)</sup> .....9QJ  
 Outline

Maximum Diameter .....	1.563 In.
Maximum Seated Height .....	3.780 In.
Maximum Overall Height .....	4.160 In.

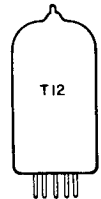
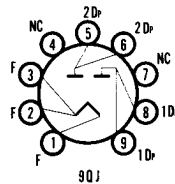

**ELECTRICAL DATA**

**FILAMENT OPERATION**

Filament Voltage.....	5.0 Volts
Filament Current .....	3000 Ma

**RATINGS (Design Maximum Rating System)**

**Rectifier Service<sup>(3)</sup>**

Peak Inverse Plate Voltage (Max.) .....	1700 Volts
AC Plate Supply Voltage (Each Plate, RMS) (Max.) .....	600 Volts
Steady State Peak Plate Current (Each Plate) (Max.) .....	1000 Ma
Transient Peak Plate Current (Each Plate) (Max.) .....	5000 Ma

**CHARACTERISTICS AND TYPICAL OPERATION**

**Full-Wave Rectifier—Capacitor Input Filter**

AC Plate Supply Voltage (Each Plate, RMS) <sup>(4)</sup> .....	300	450	550 Volts
Filter Input Capacitor.....	40	40	40 $\mu$ f
Effective Plate Supply Resistance (Each Plate) .....	21	67	97 Ohms
DC Output Current.....	150-300	137.5-275	81-162 Ma
DC Output Voltage at Filter Input.....	335-290	520-460	680-630 Volts

**Full-Wave Rectifier—Choke Input Filter**

AC Plate Supply Voltage (Each Plate, RMS) <sup>(4)</sup> .....	450	550 Volts
Filter Input Choke.....	10	10 Henrys
DC Output Current .....	174-348	137.5-275 Ma
DC Output Voltage at Filter Input .....	355-340	455-440 Volts
Tube Voltage Drop for I <sub>b</sub> = 275 Ma.....	—	47 Volts

**NOTES:**

- (1) Horizontal operation is permitted if Pins 2 and 7 are in a vertical plane.
- (2) Pins 4 and 7 may be used as tie points for AC line providing peak value does not exceed 200 volts.
- (3) For use with sinusoidal supply voltages within the frequency range of 25 to 1000 hertz.
- (4) AC plate voltage is measured without load.

RATING CHART (5BC3)

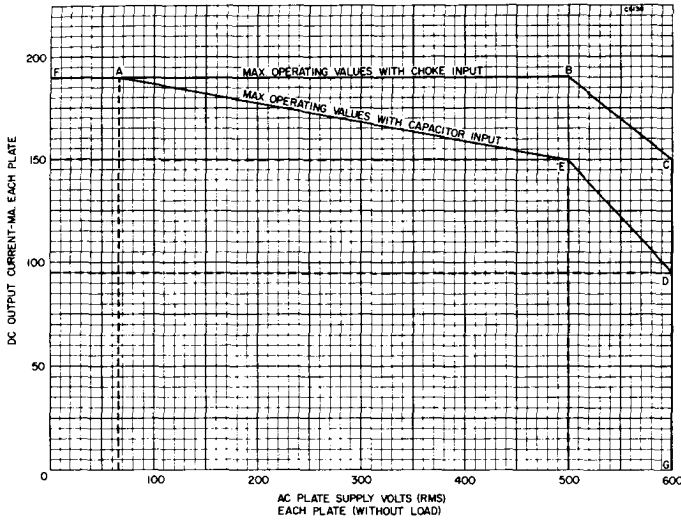

**FULL-WAVE POWER RECTIFIER**

**5BC3A**

**Filamentary Twin Diode**

Construction .....Novar T-12  
 Base .....Large Button 9 Pin, E9-88  
 (Exhaust Tip on Base)  
 Basing .....9QJ  
 Outline .....12-99  
 Maximum Diameter .....1.563 In.  
 Maximum Seated Height .....3.500 In.  
 Maximum Overall Height .....3.880 In.  
 The 5BC3A is identical to the 5BC3 except  
 for base with exhaust tip at bottom and shorter bulb.

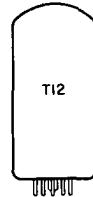
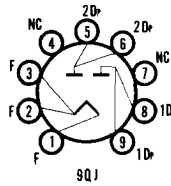

**FULL-WAVE POWER RECTIFIER**

**5D14**

**Filamentary Twin Diode**

Construction .....Octal T-12  
 Base .....Octal 8 Pin, B8-118  
 Basing<sup>(1)</sup> .....8KS  
 Outline .....12-16  
 Maximum Diameter .....1.563 In.  
 Maximum Seated Height .....4.063 In.  
 Maximum Overall Height .....4.625 In.

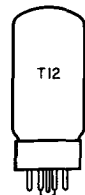
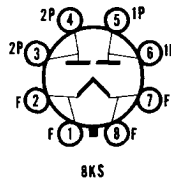

**ELECTRICAL DATA**

**FILAMENT OPERATION**

Filament Voltage.....  
 Filament Current.....

5.0 Volts  
 3000 Ma

**RATINGS (Design Maximum Rating System)**

**Rectifier Service<sup>(2)</sup>**

Peak Inverse Plate Voltage (Max.) .....	1700 Volts
AC Plate Supply Voltage (Each Plate, RMS) (Max.) .....	600 Volts
Steady State Peak Plate Current (Each Plate) (Max.) .....	1000 Ma
Transient Peak Plate Current (Each Plate) (Max.) .....	5000 Ma

**CHARACTERISTICS AND TYPICAL OPERATION**

**Full-Wave Rectifier—Capacitor Input Filter**

AC Plate Supply Voltage (Each Plate, RMS) <sup>(3)</sup> .....	300	450 Volts
Filter Input Capacitor .....	40	40 $\mu$ f
Effective Plate-Supply Resistance (Each Plate) .....	21	67 Ohms
DC Output Current .....	300	275 Ma
DC Output Voltage at Filter Input .....	290	460 Volts

**Full-Wave Rectifier—Choke Input Filter**

AC Plate Supply Voltage (Each Plate, RMS) <sup>(3)</sup> .....		550 Volts
Filter Input Choke .....		10 Henrys
DC Output Current .....		275 Ma
DC Output Voltage at Filter Input .....		420 Volts
Tube Voltage Drop for $I_b = 225$ Ma (Each Plate) .....		44 Volts
275 Ma (Each Plate) .....		50 Volts
300 Ma (Each Plate) .....		54 Volts

**NOTES:**

- (1) Horizontal operation is permitted if Pins 2 and 4 are in a vertical plane.
- (2) For use with sinusoidal supply voltages within the frequency range of 25 to 1000 Hertz.
- (3) AC plate voltage is measured without load.



**Filamentary Twin Diode**

Construction .....	Octal T-12
Base .....	B5-121, B5-127 or B8-118
Basing <sup>(1)</sup> .....	.5T
Outline .....	.12-16
Maximum Diameter .....	1.563 In.
Maximum Seated Height .....	4.063 In.
Maximum Overall Height .....	4.625 In.

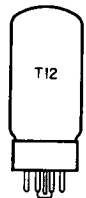
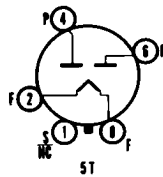

**ELECTRICAL DATA**

**FILAMENT OPERATION**

Filament Voltage .....	5.0 Volts
Filament Current .....	3000 Ma

**RATINGS (Design Center Rating System)**

**Rectifier Service<sup>(2)</sup>**

Peak Inverse Plate Voltage (Max.) .....	1550 Volts
AC Plate Supply Voltage (Each Plate, RMS) (Max.) .....	550 Volts
Steady State Peak Plate Current (Each Plate) (Max.) .....	1.0 Amperes
Transient Peak Plate Current (Each Plate) (Max.) .....	4.6 Amperes

**CHARACTERISTICS AND TYPICAL OPERATION**

**Full-Wave Rectifier—Capacitor Input Filter**

AC Plate Supply Voltage (Each Plate, RMS) <sup>(3)</sup> .....	300	450 Volts
Filter Input Capacitor .....	40	40 $\mu$ f
Effective Plate-Supply Resistance (Each Plate) .....	21	67 Ohms
DC Output Current .....	300	275 Ma
DC Output Voltage at Filter Input .....	290	460 Volts

**Full-Wave Rectifier—Choke Input Filter**

AC Plate Supply Voltage (Each Plate, RMS) <sup>(3)</sup> .....		550 Volts
Filter Input Choke .....		10 Henrys
DC Output Current .....		275 Ma
DC Output Voltage at Filter Input .....		420 Volts
Tube Voltage Drop for $I_b = 225$ Ma (Each Plate) .....		44 Volts
275 Ma (Each Plate) .....		50 Volts
300 Ma (Each Plate) .....		54 Volts

**NOTES:**

- (1) Horizontal operation is permitted if Pins 1 and 4 are in a vertical plane.
- (2) For use with sinusoidal supply voltages within the frequency range of 25 to 1000 Hertz.
- (3) AC plate voltage is measured without load.

RATING CHART (5U4GB)

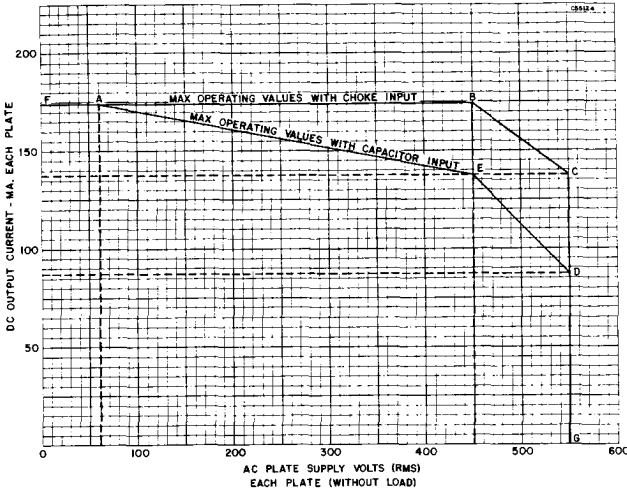

Color Television Type  
**FULL-WAVE POWER RECTIFIER**

**5V3A**

**Filamentary Twin Diode**

- Construction ..... Octal T-12
- Base ..... B8-110, B5-121 or B8-118
- Basing<sup>(1)</sup> ..... 5T
- Outline ..... 12-16
- Maximum Diameter ..... 1.563 In.
- Maximum Seated Height ..... 4.063 In.
- Maximum Overall Height ..... 4.625 In.

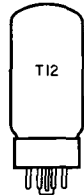
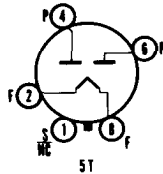

**ELECTRICAL DATA**

**FILAMENT OPERATION**

- Filament Voltage ..... 5.0 Volts
- Filament Current ..... 3000 Ma

**RATINGS (Design Maximum Rating System)**

**Rectifier Service<sup>(2)</sup>**

- Peak Inverse Plate Voltage (Max.) ..... 1550 Volts
- AC Plate Supply Voltage (Each Plate RMS) (Max.) ..... 550 Volts
- DC Output Current (Condenser Input) (Max.) ..... 415 Ma
- Steady State Peak Plate Current (Each Plate) (Max.) ..... 1400 Ma
- Transient Peak Plate Current (Each Plate) (Max.) ..... 6600 Ma
- Bulb Temperature at Hottest Point ..... 240 °C

**CHARACTERISTICS AND TYPICAL OPERATION**

**Full-Wave Rectifier—Capacitor Input Filter**

- AC Plate Supply Voltage (Each Plate RMS)<sup>(3)</sup> ..... 300 425 Volts
- Filter Input Capacitor ..... 40 40 μf
- Effective Plate Supply Resistance (Each Plate) ..... 20 50 Ohms
- DC Output Current ..... 380 350 Ma
- DC Output Voltage at Filter Input ..... 300 440 Volts

**Full-Wave Rectifier—Choke Input Filter**

- AC Plate Supply Voltage (Each Plate RMS)<sup>(3)</sup> ..... 500 Volts
- Filter Input Choke ..... 10 Henrys
- DC Output Current ..... 350 Ma
- DC Output Voltage at Filter Input ..... 390 Volts
- Tube Voltage Drop for I<sub>b</sub> = 350 Ma (Each Plate) ..... 42 Volts

**NOTES:**

- (1) Horizontal operation is permitted if Pins 2 and 4 are in a vertical plane.
- (2) For use with sinusoidal supply voltages within the frequency range of 25 to 1000 Hertz.
- (3) AC plate voltage is measured without load.

**RATING CHART (5V3A)**

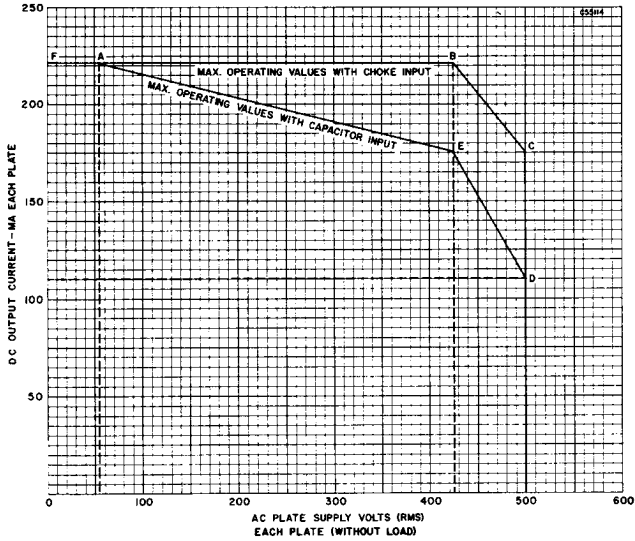

**5V4GA**

**FULL-WAVE POWER RECTIFIER**

**Heater-Cathode Twin Diode**

- Construction ..... Octal T-12
- Base ..... 5 Pin, B5-15
- Basing ..... .5L
- Outline ..... 12-14
- Maximum Diameter ..... 1.563 In.
- Maximum Seated Height ..... 3.313 In.
- Maximum Overall Height ..... 3.875 In.

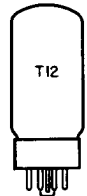
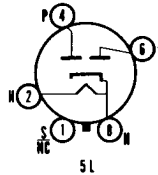

**ELECTRICAL DATA**

**HEATER OPERATION**

- Heater Voltage..... 5.0 Volts
- Heater Current ..... 2000 Ma

**RATINGS (Design Maximum Rating System)**

**Rectifier Service<sup>(1)</sup>**

- Peak Inverse Plate Voltage (Max.) ..... 1400 Volts
- Steady State Peak Plate Current (Each Plate) (Max.) ..... 525 Ma
- Transient Peak Plate Current (Each Plate) (Max.) ..... 3500 Ma

**CHARACTERISTICS AND TYPICAL OPERATION**

**Full-Wave Rectifier—Capacitor Input Filter**

- AC Plate Supply Voltage (Each Plate RMS)<sup>(2)</sup> ..... 375 Volts
- Filter Input Capacitor..... 10  $\mu$ f
- Effective Plate Supply Resistance (Each Plate) ..... 100 Ohms
- DC Output Current..... 175 Ma
- DC Output Voltage at Filter Input ..... 410 Volts

**Full-Wave Rectifier—Choke Input Filter**

- AC Plate Supply Voltage (Each Plate RMS)<sup>(2)</sup> ..... 500 Volts
- Filter Input Choke (Min.) ..... 4 Henrys
- DC Output Current..... 175 Ma
- DC Output Voltage at Filter Input ..... 410 Volts
- Tube Voltage Drop for  $I_b = 175$  Ma (Each Plate) ..... 25 Volts

**NOTES:**

- (1) For use with sinusoidal supply voltages within the frequency range of 25 to 1000 Hertz.
- (2) AC plate voltage is measured without load.

Color Television Type  
**FULL-WAVE POWER RECTIFIER**

**5Y3GT**

**Filamentary Twin Diode**

Construction .....Octal T-9  
 Base.....5 Pin, B5-10 or B5-62  
 Basing<sup>(1)</sup>.....5T  
 Outline .....9-13 or 9-42  
 Maximum Diameter .....1.188 In.  
 Maximum Seated Height .....2.813 In.  
 Maximum Overall Height .....3.375 In.

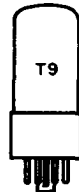
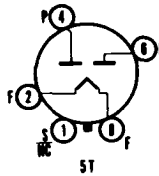

**ELECTRICAL DATA**

**FILAMENT OPERATION**

Filament Voltage ..... 5.0 Volts  
 Filament Current ..... 2000 Ma

**RATINGS (Design Maximum Rating System)**

**Rectifier Service<sup>(2)</sup>**

Peak Inverse Plate Voltage (Max.) ..... 1400 Volts  
 AC Plate Supply Voltage (Each Plate) (Max.)<sup>(2)</sup> ..... 500 Volts  
 DC Output Current (Each Plate) (Condenser Input) (Max.) ..... 42 Ma  
 Steady State Peak Plate Current (Each Plate) (Max.) ..... 400 Ma  
 Transient Peak Plate Current (Each Plate) (Max.) ..... 2.2 Amperes  
 Tube Voltage Drop for  $I_b = 125$  Ma (Each Plate) ..... 60 Volts

**CHARACTERISTICS AND TYPICAL OPERATION**

**Full-Wave Rectifier Service—Capacitor Input Filter**

AC Plate Supply Voltage (Each Plate RMS)<sup>(2)</sup> ..... 350 Volts  
 Input Capacitor ..... 10  $\mu$ f  
 Effective Plate Supply Impedance (Each Plate) ..... 50 Ohms  
 DC Output Current ..... 125 Ma  
 DC Output Voltage ..... 350 Volts

**Full-Wave Rectifier Service—Choke Input Filter**

AC Plate Supply Voltage (Each Plate RMS)<sup>(2)</sup> ..... 500 Volts  
 Input Choke ..... 10 Henrys  
 DC Output Current ..... 125 Ma  
 DC Output Voltage ..... 390 Volts

**NOTES:**

- (1) Horizontal operation permitted if Pins 2 and 4 are in a vertical plane.
- (2) For use with sinusoidal supply voltages within the frequency range of 25 to 1000 Hertz.
- (3) AC plate voltage is measured without load.

**RATING CHART**

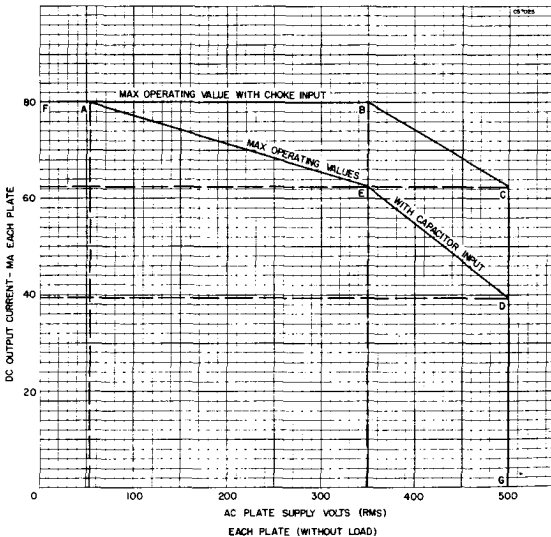

Positive Grid No. 1 Voltage (Max.) .....	0 Volt
Plate Dissipation (Max.) .....	2.5 Watts
Grid No. 2 Dissipation (Max.) .....	0.55 Watt
Grid No. 1 Circuit Resistance	
Self Bias (Max.) .....	1.0 Megohm
Fixed Bias (Max.) .....	0.25 Megohm

**Diode Section (Each Diode)**

Continuous Diode Current (Max.) .....	5.0 Ma
---------------------------------------	--------

**CHARACTERISTICS AND TYPICAL OPERATION**

**Pentode Section**

Plate Voltage .....	125 Volts
Grid No. 2 Voltage .....	125 Volts
Grid No. 1 Voltage .....	-1 Volt
Plate Current .....	12 Ma
Grid No. 2 Current .....	4.5 Ma
Transconductance .....	10,000 $\mu$ mhos
Plate Resistance (Approx.) .....	150,000 Ohms
Grid No. 1 Voltage for $I_b = 20 \mu$ a (Approx.) .....	-7 Volts

**Diode Section (Each Diode)**

Tube Voltage Drop for $I_b = 50$ Ma .....	10 Volts
---	----------

**AVERAGE PLATE CHARACTERISTICS**

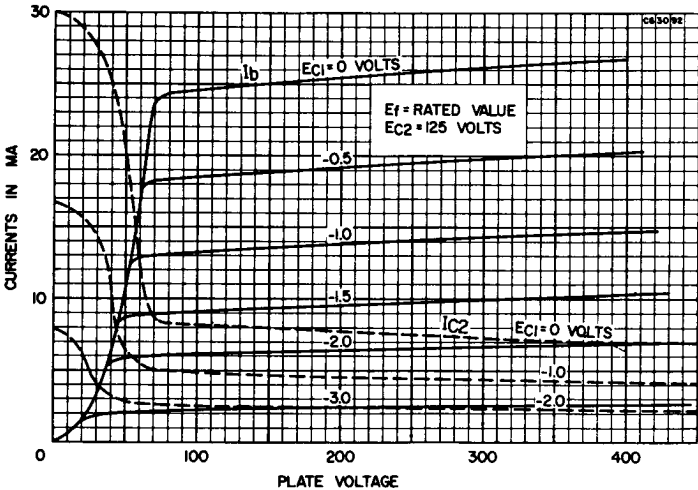

**6AC10**  
8AC10

Color Television Type  
**COLOR MATRIX AMPLIFIER**

**Medium Mu Triple Triode**

Construction .....	Compactron T-9
Base .....	Button 12 Pin, E12-70
Basing .....	12FE
Outline .....	9-59
Maximum Diameter .....	1.188 In.
Maximum Seated Height .....	2.000 In.
Maximum Overall Height .....	2.375 In.

**ELECTRICAL DATA**

**HEATER OPERATION**

Heater Voltage .....	8.4
Heater Current .....	450
Heater Warm-up Time .....	11

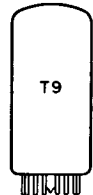
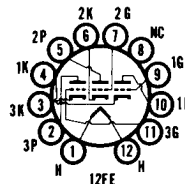

**8AC10 Series**

**6AC10 Parallel**

**6AC10 Series**

6.3 $\pm$ 0.6	6.3 Volts
0.6	600 Ma
—	11 Seconds



Maximum Heater-Cathode Voltage	
Heater Negative with Respect to Cathode	
Total DC and Peak .....	200 Volts
Heater Positive with Respect to Cathode	
DC .....	100 Volts
Total DC and Peak .....	200 Volts

**DIRECT INTERELECTRODE CAPACITANCES (Unshielded)**

	Section No. 1	Section No. 2	Section No. 3
Grid to Plate .....	1.3	1.2	1.2 Pf
Input .....	2.4	2.6	2.6 Pf
Output .....	0.22	0.30	0.44 Pf

**RATINGS (Design Maximum Rating System) (Each Section)**

Plate Voltage (Max.) .....	330 Volts
Plate Dissipation (Max.) .....	2.0 Watts
Grid Circuit Resistance (Max.) .....	0.5 Megohms

**CHARACTERISTICS AND TYPICAL OPERATION**

Plate Voltage .....	200 Volts
Cathode-Bias Resistor .....	150 Ohms
Amplification Factor .....	62
Plate Resistance (Approx.) .....	10,700 Ohms
Transconductance .....	5800 $\mu$ mhos
Plate Current .....	9.0 Ma
Grid Voltage for Ib = 100 $\mu$ a .....	-5 Volts

Color Television Type

**AUDIO POWER AMPLIFIER  
FM DETECTOR**

**6AD10**

**Beam Pentode and Sharp Cutoff Pentode**

Construction .....	Compactron T-9
Base .....	Button 12 Pin, E12-70
Basing .....	12EZ
Outline .....	9-59
Maximum Diameter .....	1.188 In.
Maximum Seated Height .....	2.000 In.
Maximum Overall Height .....	2.375 In.

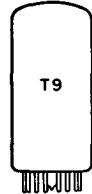
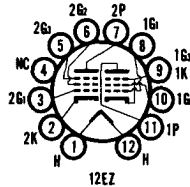

**ELECTRICAL DATA**

**HEATER OPERATION**

Heater Voltage .....	6.3 Volts
Heater Current .....	1050 Ma
Maximum Heater-Cathode Voltage	
Heater Negative with Respect to Cathode	
Total DC and Peak .....	200 Volts
Heater Positive with Respect to Cathode	
DC .....	100 Volts
Total DC and Peak .....	200 Volts

**DIRECT INTERELECTRODE CAPACITANCES (Unshielded)**

**Section No. 1 (Power Amplifier)**

Grid to Plate .....	0.26 Pf
Input: g to (h + 1k + 1g2 + 1g3 + IS) .....	11.0 Pf
Output: p to (h + 1k + 1g2 + 1g3 + IS) .....	11.0 Pf

**Section No. 2 (FM Detector)**

Grid No. 1 to Plate (Max.) .....	0.024 Pf
Grid No. 3 to Plate .....	3.4 Pf
Grid No. 1 to (h + 2k + 2g2 + 2g3 + IS) .....	8.0 Pf
Grid No. 3 to (h + 2k + 2g1 + 2g2 + 2p + IS) .....	9.5 Pf
Grid No. 1 to Grid No. 3 .....	0.12 Pf
Plate No. 1 to Plate No. 2 .....	0.34 Pf

**RATINGS (Design Maximum Rating System)**

**Section No. 1 (Power Amplifier)**

Plate Voltage .....	275 Volts
Screen Voltage .....	275 Volts
Plate Dissipation .....	10 Watts
Screen Dissipation .....	2.0 Watts
Grid No. 1 Circuit Resistance	
Fixed Bias .....	0.25 Megohm
Cathode Bias .....	0.5 Megohm

**Section No. 2 (FM Detector)**

Plate Voltage .....	300 Volts
---------------------	-----------

Suppressor Voltage .....	-100 to +25 Volts
Screen Supply Voltage.....	300 Volts
Positive DC Grid Voltage.....	0 Volt
Plate Dissipation .....	1.7 Watts
Screen Dissipation.....	1.0 Watt
Grid No. 3 Dissipation .....	0.1 Watt
Grid No. 3 Circuit Resistance .....	0.68 Megohm
Grid No. 1 Circuit Resistance .....	
Fixed Bias .....	0.22 Megohm
Cathode Bias .....	0.47 Megohm

**CHARACTERISTICS AND TYPICAL OPERATION**

**Section No. 1 (Power Amplifier)**

**Class A1 Amplifier**

Plate Voltage .....	250 Volts
Screen Voltage.....	250 Volts
Grid No. 1 Voltage .....	-8.0 Volts
Peak AF Grid Voltage .....	8.0 Volts
Plate Resistance (Approx.) .....	100,000 Ohms
Transconductance .....	6500 $\mu$ mhos
Zero Signal Plate Current.....	35 Ma
Maximum Signal Plate Current .....	39 Ma
Zero Signal Screen Current .....	2.5 Ma
Maximum Signal Screen Current .....	7.0 Ma
Load Resistance .....	5000 Ohms
Total Harmonic Distortion (Approx.).....	10 Percent
Maximum Signal Power Output.....	4.2 Watts

**Section No. 2 (FM Detector)**

Plate Voltage .....	150 Volts
Suppressor Voltage .....	0 Volt
Screen Voltage.....	100 Volts
Cathode Resistor .....	180 Ohms
Plate Resistance (Approx.) .....	110,000 Ohms
Transconductance (G1) .....	3400 $\mu$ mhos
Transconductance (G3) .....	600 $\mu$ mhos
Plate Current .....	2.8 Ma
Screen Current .....	3.4 Ma
Ec1 for Ib = 20 $\mu$ a .....	-4.5 Volts
Ec3 for Ib = 20 $\mu$ a .....	-7 Volts



**Heater-Cathode Diode**

Construction .....	Miniature T-6 $\frac{1}{2}$
Base .....	Button 9 Pin, E9-1
Top Cap .....	C1-1
Basing .....	.9CB
Outline .....	.6-8
Maximum Diameter .....	0.875 In.
Maximum Seated Height .....	3.000 In.
Maximum Overall Height .....	3.281 In.

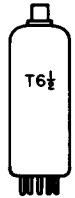
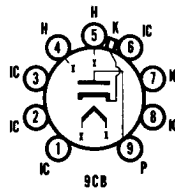

**ELECTRICAL DATA  
HEATER OPERATION**

	<b>12AF3 Series</b>	<b>6AF3 Parallel</b>
Heater Voltage.....	12.6	6.3 Volts
Heater Current .....	600	1200 Ma
Heater Warm-up Time .....	11	— Seconds
Maximum Heater-Cathode Voltage		
Heater Negative with Respect to Cathode		
DC .....		1000 Volts
Total DC and Peak .....		4500 Volts
Heater Positive with Respect to Cathode		
DC .....		100 Volts
Total DC and Peak .....		300 Volts

**DIRECT INTERELECTRODE CAPACITANCES**

Heater to Cathode .....	2.8 Pf
Plate to Cathode and Heater.....	6.0 Pf
Cathode to Plate and Heater.....	9.0 Pf

**RATINGS (Design Maximum Rating System)**

**Damper Service**

Peak Inverse Plate Voltage (Max.) <sup>(1)</sup> .....	4500 Volts
Plate Dissipation (Max.) .....	6.0 Watts
Steady State Peak Current (Max.) .....	750 Ma
DC Plate Current (Max.) .....	185 Ma
Bulb Temperature (Max.).....	220 °C

**CHARACTERISTICS AND TYPICAL OPERATION**

Tube Voltage Drop for Ib = 350 Ma .....	25 Volts
---	----------

**NOTE:**

(1) For operation in a 525 line, 30 frame system as described in "Standards of Good Engineering Practice for Television Broadcast Stations; Federal Communications Commission," the duty cycle of the voltage pulse must not exceed 15% of one horizontal scanning cycle.

**AGC KEYSER, SYNC SEPARATOR AND VIDEO AMPLIFIER**

**6AF11**

10AF11, 12AF11, 15AF11

**Hi Mu Triode, Medium Mu Triode and Sharp Cutoff Pentode**

Construction.....Compactron T-9  
 Base .....Button 12 Pin, E12-70  
 Basing .....12DP  
 Outline .....9-58  
 Maximum Diameter .....1.188 In.  
 Maximum Seated Height .....2.250 In.  
 Maximum Overall Height .....2.625 In.

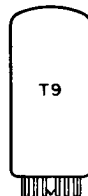
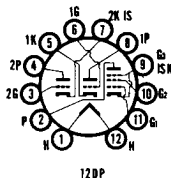

**ELECTRICAL DATA**

**HEATER OPERATION**

	15AF11 Series	12AF11 Series	10AF11 Series	6AF11 Parallel
Heater Voltage.....	14.7	12.6	9.8	6.3 Volts
Heater Current .....	450	450	600	1050 Ma
Heater Warm-up Time .....	11	11	11	— Seconds
Maximum Heater-Cathode Voltage				
Heater Negative With Respect to Cathode				
Total DC and Peak.....				200 Volts
Heater Positive With Respect to Cathode				
DC .....				100 Volts
Total DC and Peak.....				200 Volts

**DIRECT INTERELECTRODE CAPACITANCES (Unshielded)**

**Triode No. 1**

Grid to Plate .....	1.9 Pf
Input: 1Tg1 to (1Tk + 2Tk + Pk + Pg3 + h + IS) .....	3.0 Pf
Output: 1Tp to (1Tk + 2Tk + Pk + Pg3 + h + IS) .....	2.2 Pf

**Triode No. 2**

Grid to Plate .....	3.6 Pf
Input: 2Tg1 to (2Tk + Pk + Pg3 + h + IS) .....	2.4 Pf
Output: 2Tp to (2Tk + Pk + Pg3 + h + IS) .....	3.8 Pf

**Pentode**

Grid to Plate .....	0.12 Pf
Input: Pg1 to (2Tk + Pk + Pg2 + Pg3 + h + IS) .....	10.0 Pf
Output: Pp to (2Tk + Pk + Pg2 + Pg3 + h + IS) .....	4.5 Pf

**Coupling**

Pentode Plate to Triode No. 2 Plate (Max.) .....	0.045 Pf
Triode No. 1 Plate to Triode No. 2 Plate (Max.) .....	0.06 Pf

**RATINGS (Design Maximum Rating System)**

**Triode No. 1**

Plate Voltage (Max.) .....	330 Volts
Positive DC Grid Voltage (Max.) .....	0 Volt
Plate Dissipation (Max.) .....	1.1 Watts
Grid Circuit Resistance	
Fixed Bias (Max.) .....	0.5 Megohm
Cathode Bias (Max.) .....	1.0 Megohm

**Triode No. 2**

Plate Voltage (Max.) .....	330 Volts
Positive DC Grid Voltage (Max.) .....	0 Volt
Plate Dissipation (Max.) .....	2.0 Watts

Grid Circuit Resistance	
Fixed Bias (Max.)	0.5 Megohm
Cathode Bias (Max.)	1.0 Megohm
<b>Pentode</b>	
Plate Voltage (Max.)	330 Volts
Screen Supply Voltage (Max.)	330 Volts
Screen Voltage	See Rating Chart (Gen. Info. Sec.)
Positive DC Grid No. 1 Voltage	0 Volt
Plate Dissipation	5.0 Watts
Screen Dissipation	1.25 Watts
Grid No. 1 Circuit Resistance	
Fixed Bias	0.25 Megohm
Cathode Bias	1.0 Megohm

**CHARACTERISTICS AND TYPICAL OPERATION**

**Triode No. 1**

Plate Voltage	200 Volts
Grid Voltage	-2.0 Volts
Amplification Factor	68
Plate Resistance (Approx.)	12,400 Ohms
Transconductance	5500 $\mu$ mhos
Plate Current	7.0 Ma
Grid Voltage (Approx.)	
Ib = 10 $\mu$ a	-5.5 Volts

**Triode No. 2**

Plate Voltage	200 Volts
Cathode-Bias Resistor	220 Ohms
Amplification Factor	41
Plate Resistance (Approx.)	9400 Ohms
Transconductance	4400 $\mu$ mhos
Plate Current	9.2 Ma
Grid Voltage (Approx.)	
Ib = 10 $\mu$ a	-6.5 Volts

**Pentode Section**

Plate Voltage	50	200 Volts
Screen Voltage	150	150 Volts
Grid No. 1 Voltage	0	— Volts
Cathode-Bias Resistor	—	100 Ohms
Plate Resistance (Approx.)	—	68,000 Ohms
Transconductance	—	11,000 $\mu$ mhos
Plate Current	55	24 Ma
Screen Current	18	4.8 Ma
Grid No. 1 Voltage (Approx.)		
Ib = 100 $\mu$ a	—	-10 Volts



Color Television Type

**AGC AMPLIFIER  
AND VIDEO AMPLIFIER**

**Triode and Frame Grid Pentode**

Construction	Compactron T-9
Base	Button 12 Pin, E12-70
Basing	.12HE
Outline	9-59
Maximum Diameter	1.188 In.
Maximum Seated Height	2.250 In.
Maximum Overall Height	2.625 In.

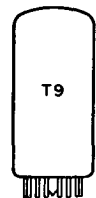
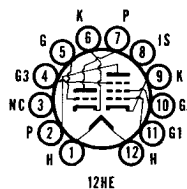

**ELECTRICAL DATA**

**HEATER OPERATION**

Heater Voltage	6.3 Volts
Heater Current	820 Ma
Maximum Heater-Cathode Voltage	
Heater Negative with Respect to Cathode	
Total DC and Peak	200 Volts
Heater Positive with Respect to Cathode	
DC	100 Volts
Total DC and Peak	200 Volts

**DIRECT INTERELECTRODE CAPACITANCES (Unshielded)**

**Triode**

Grid to Plate	2.8 Pf
Input: Tg to (h + Tk + IS)	3.6 Pf
Output: Tp to (h + Tk + IS)	2.2 Pf

**Pentode**

Grid No. 1 to Plate .....	0.16 Pf
Input: P <sub>g1</sub> to (h + P <sub>k</sub> + P <sub>g2</sub> + P <sub>g3</sub> + IS) .....	17 Pf
Output: P <sub>p</sub> to (h + P <sub>k</sub> + P <sub>g2</sub> + P <sub>g3</sub> + IS) .....	6.5 Pf

**RATINGS (Design Maximum Rating System)**

	<b>Pentode Section</b>	<b>Triode Section</b>
Plate Voltage (Max.) .....	330	330 Volts
Screen Voltage (Max.) .....	200	— Volts
Positive DC Grid No. 1 Voltage (Max.) .....	0	0 Volt
Plate Dissipation (Max.) .....	10	1.1 Watts
Screen Dissipation (Max.) .....	1.5	— Watts
Grid No. 1 Circuit Resistance		
With Fixed Bias (Max.) .....	0.1	0.5 Megohm
With Cathode Bias (Max.) .....	0.25	1.0 Megohm

**CHARACTERISTICS AND TYPICAL OPERATION**

	<b>Pentode Section</b>	<b>Triode Section</b>
Plate Voltage .....	55 250	150 Volts
Screen Voltage .....	125 150	— Volts
Grid No. 1 Voltage .....	0 —	— Volt
Cathode-Bias Resistor .....	— 56	350 Ohms
Amplification Factor .....	— —	39
Plate Resistance (Approx.) .....	— 40,000	8500 Ohms
Transconductance .....	— 30,000	4600 $\mu$ mhos
Plate Current .....	56 28	6.2 Ma
Screen Current .....	21 5.6	— Ma
Grid No. 1 Voltage (Approx.)		
I <sub>b</sub> = 20 $\mu$ a .....	— —	-7 Volts
Grid No. 1 Voltage (Approx.)		
I <sub>b</sub> = 100 $\mu$ a .....	— -5.4	— Volts

**FM STEREO MULTIPLEXER**

**6AG11**

30AG11

**Double Diode, Twin Triode**

Construction..... Compactron T-9  
 Base ..... Button 12 Pin, E12-70  
 Basing ..... 12DA  
 Outline ..... 9-56  
 Maximum Diameter ..... 1.188 In.  
 Maximum Seated Height ..... 1.500 In.  
 Maximum Overall Height ..... 1.875 In.

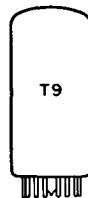
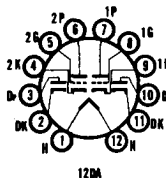

**ELECTRICAL DATA**

**HEATER OPERATION**

	<b>30AG11 Series</b>	<b>6AG11 Parallel</b>
Heater Voltage .....	30	6.3 Volts
Heater Current .....	150	750 Ma
Maximum Heater-Cathode Voltage		
Heater Negative With Respect to Cathode		
Total DC and Peak .....		200 Volts
Heater Positive With Respect to Cathode		
DC .....		100 Volts
Total DC and Peak .....		200 Volts

**DIRECT INTERELECTRODE CAPACITANCES (Unshielded)**

**Triode (Each Section)**

Grid to Plate .....	1.8 Pf
Input: g to (h + k) .....	3.8 Pf
Output: p to (h + k) .....	0.24 Pf

**Diode (Each Section)**

Plate to Cathode and Heater .....	2.2 Pf
Cathode to Plate and Heater .....	5.5 Pf

**Coupling**

Triode Grid to Diode Plate (Max.).....	0.1 Pf
No. 1 Triode Grid to No. 2 Triode Grid (Max.) .....	0.01 Pf
No. 1 Triode Plate to No. 2 Triode Plate.....	0.5 Pf

**RATINGS (Design Maximum Rating System)**

**Triode (Each Section)**

Plate Voltage (Max.) .....	330 Volts
Plate Dissipation (Max.) .....	2.0 Watts

**Diode (Each Section)**

Diode Current (Continuous Operation) (Max.) .....	5.0 Ma
---	--------

**CHARACTERISTICS AND TYPICAL OPERATION**

**Triode (Each Section)**

Plate Voltage .....	125 Volts
Grid Voltage .....	-1.0 Volt
Amplification Factor .....	66
Plate Resistance.....	8500 Ohms
Transconductance .....	7800 $\mu$ mhos
Plate Current .....	7.5 Ma
Grid Voltage for $I_b = 30 \mu$ a .....	-5 Volts

**Diode (Each Section)**

Average Diode Current for $E_b = 5$ Volts .....	18 Ma
---	-------



**Sharp Cutoff Pentode**

Construction .....	Miniature T-5½
Base .....	Button 7 Pin, E7-1
Basing .....	.7BK
Outline .....	5-2
Maximum Diameter .....	0.750 In.
Maximum Seated Height .....	1.875 In.
Maximum Overall Height .....	2.125 In.

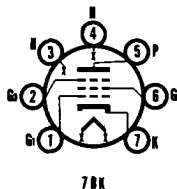

**ELECTRICAL DATA**

**HEATER OPERATION**

Heater Voltage.....	6.3 Volts
Heater Current .....	450 Ma
Maximum Heater-Cathode Voltage	
Heater Negative With Respect to Cathode	
Total DC and Peak.....	100 Volts
Heater Positive With Respect to Cathode	
Total DC and Peak.....	100 Volts

**DIRECT INTERELECTRODE CAPACITANCES (Shielded)**

Grid No. 1 to Plate (Max.).....	0.02 Pf
Input: $g_1$ to $(h + k + g_2 + g_3)$ .....	10 Pf
Output: $p$ to $(h + k + g_2 + g_3)$ .....	3.6 Pf

**RATINGS (Design Center Rating System)**

Plate Voltage (Max.) .....	300 Volts
Grid No. 2 Supply Voltage (Max.) .....	300 Volts
Grid No. 2 Voltage .....	See Rating Chart (Gen. Info. Sec.)
Plate Dissipation (Max.) .....	3.2 Watts
Grid No. 2 Dissipation (Max.) .....	0.4 Watt
Cathode Current (Max.).....	13 Ma

**CHARACTERISTICS AND TYPICAL OPERATION**

	Triode Conn.	Pentode Conn.
Plate Voltage .....	150	300 Volts
Grid No. 3 Voltage .....	Connected to Cathode at Socket	
Grid No. 2 Voltage .....	—	150 Volts
Cathode Bias Resistor .....	160	160 Ohms
Plate Current .....	12.5	10 Ma
Grid No. 2 Current .....	—	2.5 Ma
Transconductance .....	11,000	9000 $\mu$ mhos
Amplification Factor .....	40	—
Plate Resistance (Approx.) .....	3600	500K Ohms
$E_{c1}$ for $I_b = 10 \mu$ a (Approx.).....	-7	-7

Color Television Type

## VIDEO AMPLIFIER AND COLOR BLANKER

# 6AH9

9AH9

**Medium Mu Triode and  
Sharp Cutoff Frame Grid Pentode**

Construction.....Compactron T-9  
 Base .....E12-70  
 Basing .....12HJ  
 Outline .....9-58  
 Maximum Diameter .....1.188 In.  
 Maximum Seated Height .....2.000 In.  
 Maximum Overall Height .....2.375 In.

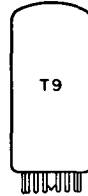
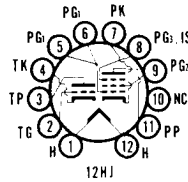

**ELECTRICAL DATA**

**HEATER OPERATION**

	<b>9AH9</b>	<b>6AH9</b>
Heater Voltage.....	8.8	6.3 Volts
Heater Current.....	600	900 Ma
Heater Warm-up Time.....	—	11 Seconds
Maximum Heater-Cathode Voltage		
Heater Negative with Respect to Cathode		
Total DC and Peak.....		200 Volts
Heater Positive with Respect to Cathode		
DC.....		100 Volts
Total DC and Peak.....		200 Volts

**DIRECT INTERELECTRODE CAPACITANCES (Without Shield)**

**Pentode Section**

Grid 1 to Plate: (g1 to P).....	0.15 pf
Input: g1 to (h + k + g2 + g3, I.S.).....	15.0 pf
Output: p to (h + k + g2 + g3, I.S.).....	6.0 pf

**Triode Section**

Grid to Plate: (g to p).....	3.7 pf
Input: g to (h + k).....	2.4 pf
Output: p to (h + k).....	0.4 pf

**RATINGS (Design Maximum Rating System)**

	<b>Triode Section</b>	<b>Pentode Section</b>
DC Plate Voltage (Max.).....	330	400 Volts
Positive DC Grid 3 Voltage (Max.).....	—	0 Volts
Grid No. 2 Supply Voltage (Max.).....	—	330 Volts
Grid No. 2 Voltage.....	See Rating Chart (Gen. Info. Sec.)	
Positive DC Grid No. 1 Voltage (Max.).....	0	0 Volt
Plate Dissipation (Max.).....	2.0	10.0 Watts
Grid No. 2 Dissipation (Max.).....	—	1.0 Watt
Grid No. 1 Circuit Resistance		
Fixed Bias (Max.).....	1.0	0.1 Megohm
Self Bias (Max.).....	—	0.25 Megohm

Note: Control grid to cathode spacing on the pentode section of this type is of such low order of magnitude as to preclude the use of voltage between these elements of more than 50 volts dc or peak ac in commercial tube checkers and shorts indicating devices, particularly where mechanical excitation of the tube is employed.

**CHARACTERISTICS AND TYPICAL OPERATION**

	<b>Triode Section</b>	<b>Pentode Section</b>	
Plate Supply Voltage.....	250	250	50 Volts
Grid No. 2 Supply Voltage.....	—	150	125 Volts
Grid No. 1 Voltage.....	-9	0	0 Volts
Grid No. 3 Voltage (Referred to Negative end of Rk).....	—	0	0 Volt
Cathode Resistor (Bypassed).....	—	122	0 Ohms
Plate Current.....	8	25	76 Ma
Grid No. 2 Current.....	—	6	32 <sup>(1)</sup> Ma
Transconductance (Grid No. 1 to Plate).....	2750	21,000	— μmhos
Plate Resistance (Approx.).....	7300	55,000	— Ohms
Amplification Factor.....	20	—	—
Grid No. 1 Voltage, Approx. for Ib = 100 μa (Rk = 0).....	-18	-7.2	— Volts

**NOTE:**

(1) Current drawn only for short intervals so as not to damage the tube.

# 6AK5/EF95

# RF AMPLIFIER

**Sharp Cutoff Pentode**

Construction ..... Miniature T-5½  
 Base ..... Button 7 Pin  
 Basing ..... 7BD  
 Outline ..... 5-2  
 Maximum Diameter ..... 0.750 In.  
 Maximum Seated Height ..... 1.500 In.  
 Maximum Overall Height ..... 1.750 In.

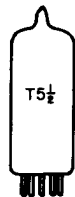
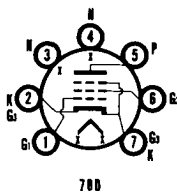

**ELECTRICAL DATA**

**HEATER OPERATION**

Heater Voltage .....	6.3 Volts
Heater Current .....	175 Ma
Maximum Heater-Cathode Voltage .....	90 Volts

**DIRECT INTERELECTRODE CAPACITANCES**

	Shielded <sup>(1)</sup>	Unshielded
Grid to Plate .....	0.02	0.03 Pf
Input .....	4.0	4.0 Pf
Output .....	2.8	2.1 Pf

**RATINGS (Design Center Rating System)**

Plate Voltage (Max.) .....	180 Volts
Plate Dissipation (Max.) .....	1.7 Watts
Screen Voltage (Max.) .....	140 Volts
Screen Dissipation (Max.) .....	0.5 Watt
Screen Supply Voltage (Max.) .....	180 Volts
Positive Control Grid Voltage (Max.) .....	0 Volt
Cathode Current (Max.) .....	18 Ma

**CHARACTERISTICS AND TYPICAL OPERATION**

**Class A1 Amplifier**

Plate Voltage .....	120	180 Volts
Screen Voltage .....	120	120 Volts
Cathode Bias Resistor <sup>(2)</sup> .....	180	180 Ohms
Plate Current .....	7.5	7.7 Ma
Screen Current .....	2.5	2.4 Ma
Transconductance .....	5000	5100 μmhos
Plate Resistance (Approx.) .....	0.30	0.50 Megohm

**NOTES:**

- (1) Shield No. 316 connected to cathode.
- (2) Fixed bias operation is not recommended.

# 6AK10

9AK10

Color Television Type

# COLOR DIFFERENCE AMPLIFIER

**Triple Triode**

Construction ..... Compactron T-9  
 Base ..... E12-70  
 Basing ..... 12FE  
 Outline ..... 9-59  
 Maximum Diameter ..... 1.188 In.  
 Maximum Seated Height ..... 2.250 In.  
 Maximum Overall Height ..... 2.625 In.

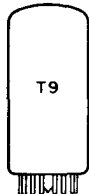
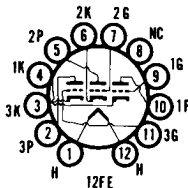

**ELECTRICAL DATA**

**HEATER OPERATION**

	9AK10	6AK10
Heater Voltage .....	9.5	6.3 Volts
Heater Current .....	600	900 Ma
Heater Warm-up Time .....	11	— Seconds
Maximum Heater Cathode Voltage		
Heater Negative with Respect to Cathode		
Total DC and Peak .....		200 Volts
Heater Positive with Respect to Cathode		
DC .....		100 Volts
Total DC and Peak .....		200 Volts



**DIRECT INTERELECTRODE CAPACITANCES (Unshielded)**

	Section 1	Section 2	Section 3
Grid to Plate .....	3.2	3.0	3.0 pf
Input: (G to K and H) .....	4.2	4.2	4.2 pf
Output: (P to K and H) .....	0.3	0.4	0.54 pf

**RATINGS (Design Maximum Rating System) (Each Section)**

Plate Voltage .....	330 Volts
Grid Voltage .....	
Positive Bias Value .....	0 Volt
Plate Dissipation .....	2 Watts
Grid Circuit Resistance .....	
Fixed Bias .....	0.5 Megohm

**CHARACTERISTICS AND TYPICAL OPERATION (Each Section)**

Plate Voltage .....	200 Volts
Plate Current .....	10 Ma
Amplification Factor .....	53
Plate Resistance (Approx.) .....	7500 Ohms
Transconductance .....	7000 $\mu$ mhos
Ecl for Ib = 100 $\mu$ a .....	-7 Volts

**DAMPER**

**6AL3/EY88**

**Heater-Cathode Diode**

Construction .....	Miniature T-6½
Base .....	E9-1
Top Cap .....	C1-2
Basing .....	9CB
Outline .....	.6-101
Maximum Diameter .....	0.875 In.
Maximum Seated Height .....	3.250 In.
Maximum Overall Height .....	3.500 In.

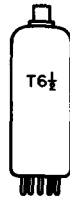
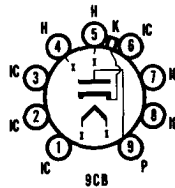

**ELECTRICAL DATA**

**HEATER OPERATION**

Heater Voltage .....	6.3 Volts
Heater Current .....	1550 Ma
Maximum Heater-Cathode Voltage .....	6600 Volts

**DIRECT INTERELECTRODE CAPACITANCES**

Plate to All Other Elements .....	8.6 Pf
Cathode to Heater .....	2.0 Pf

**RATINGS (Design Center Rating System)**

**Damper Service<sup>(1)</sup>**

Peak Inverse Plate Voltage (Absolute Max.) .....	7500 Volts
Peak Plate Current .....	550 Ma
DC Plate Current .....	220 Ma
Plate Dissipation .....	5 Watts

**NOTE:**

(1) For operation in a 525-line, 30-frame system as described in "Standards of Good Engineering Practice for Television Broadcast Stations; Federal Communications Commission." The duty cycle of the voltage pulse not to exceed 15% of a horizontal scanning cycle.

*Color Television Type*

**FM or TV DETECTOR**

**6AL5**

3AL5, 12AL5

**High Perveance Twin Diode**

Construction .....	Miniature T-5½
Base .....	Button 7 Pin
Basing .....	.6BT
Outline .....	.5-1
Maximum Diameter .....	0.750 In.
Maximum Seated Height .....	1.500 In.
Maximum Overall Height .....	1.750 In.

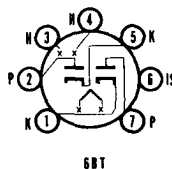

**ELECTRICAL DATA  
HEATER OPERATION**

	<b>3AL5</b>	<b>6AL5</b>	<b>12AL5</b>
Heater Voltage.....	3.15	6.3	12.6 Volts
Heater Current.....	600	300	150 Ma
Heater Warm-up Time.....	11	—	— Seconds
Maximum Heater-Cathode Voltage.....	200	330	330 Volts

**DIRECT INTERELECTRODE CAPACITANCES**

	<b>Shielded (1)</b>	<b>Unshielded</b>
Plate Input (Each Section).....	3.2	2.5 Pf
Plate to Plate.....	0.026	0.068 Pf
Cathode Input (Each Section).....	3.6	3.4 Pf

**RATINGS (Design Maximum Rating System)**

Peak Inverse Plate Voltage (Max.).....	330 Volts
Peak Plate Current Each Plate (Max.).....	54 Ma
DC Output Current Each Plate (Max.).....	9.0 Ma
AC Plate Voltage (Per Plate) (Max.).....	117 Volts
Effective Plate Supply Impedance (Each Plate) (Min.).....	300 Ohms

**CHARACTERISTICS AND TYPICAL OPERATION**

Tube Voltage Drop for Ib = 60 Ma.....	10 Volts
---------------------------------------	----------

**NOTE:**

(1) Shield No. 316 connected to Pin No. 6.



**High Mu Triode and  
Sharp Cutoff Pentode**

Construction.....	Compactron T-9
Base.....	E12-70
Basing.....	12HE
Outline.....	9-59
Maximum Diameter.....	1.188 In.
Maximum Seated Height.....	2.250 In.
Maximum Overall Height.....	2.625 In.

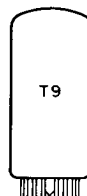
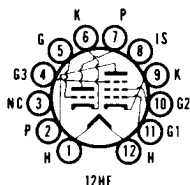

**ELECTRICAL DATA**

**HEATER OPERATION**

	<b>6AL9</b>	<b>8AL9</b>
Heater Voltage.....	6.3	8.6 Volts
Heater Current.....	820	600 Ma
Heater Warm-up Time.....	—	11 Seconds
Maximum Heater-Cathode Voltage		
Heater Negative with Respect to Cathode		
Total DC and Peak.....		200 Volts
Heater Positive with Respect to Cathode		
DC.....		100 Volts
Total DC and Peak.....		200 Volts

**DIRECT INTERELECTRODE CAPACITANCES (Unshielded)**

**Triode Section**

Grid to Plate.....	2.8 pf
Input: g to (h + Tk + Pk, g3, I.S.).....	3.6 pf
Output: p to (h + Tk + Pk, g3, I.S.).....	2.2 pf

**Pentode Section**

Grid No. 1 to Plate (Max.).....	0.16 pf
Input: g1 to (h + Pk, g3, I.S. + g2).....	17 pf
Output: p to (h + Pk, g3, I.S. + g2).....	6.4 pf

**RATINGS (Design Maximum Values)**

	<b>Triode Section</b>	<b>Pentode Section</b>
Plate Voltage.....	330	330 Volts
Grid No. 2 Supply Voltage (Max.).....	—	200 Volts
Positive Grid No. 1 Voltage (Max.).....	0	0 Volt
Grid No. 2 Dissipation (Max.).....	—	1.5 Watts
Grid No. 1 Circuit Resistance		
Fixed Bias (Max.).....	0.5	0.1 Megohm
Cathode Bias (Max.).....	1.0	0.25 Megohm

**CHARACTERISTICS AND TYPICAL OPERATION**

	<b>Triode Section</b>	<b>Pentode Section</b>
Plate Voltage .....	200	55 250 Volts
Grid No. 1 Voltage .....	—	0 — Volt
Grid No. 2 Voltage .....	—	125 150 Volts
Cathode Bias Resistor .....	270	— 56 Ohms
Plate Current .....	7.6	56 28 Ma
Grid No. 2 Current .....	—	21 5.6 Ma
Transconductance .....	6300	— 30,000 $\mu$ mhos
Amplification Factor .....	59	—
Plate Resistance (Approx.) .....	9200	— 40,000 Ohms
Ec1 for Ib = 100 $\mu$ a (Approx.) .....	-63	— -5.4 Volts

**VIDEO DETECTOR  
AND IF AMPLIFIER**

**6AM8A**  
5AM8

**Diode and Sharp Cutoff Pentode**

Construction ..... Miniature T-6½  
 Base ..... Button 9 Pin, E9-1  
 Basing ..... 9CY  
 Outline ..... 6-2  
 Maximum Diameter ..... 0.875 In.  
 Maximum Seated Height ..... 1.938 In.  
 Maximum Overall Height ..... 2.188 In.

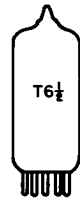
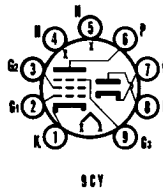

**ELECTRICAL DATA  
HEATER OPERATION**

	<b>5AM8 Series</b>	<b>6AM8A Parallel</b>
Heater Voltage.....	4.7	6.3 Volts
Heater Current .....	600	450 Ma
Heater Warm-up Time .....	11	11 Seconds
Maximum Heater-Cathode Voltage		
Heater Negative With Respect to Cathode		
Total DC and Peak.....		200 Volts
Heater Positive With Respect to Cathode		
DC .....		100 Volts
Total DC and Peak.....		200 Volts

**DIRECT INTERELECTRODE CAPACITANCES (Shielded)<sup>(1)</sup>**

<b>Pentode</b>	
Grid to Plate (Max.).....	0.015 Pf
Input .....	6.0 Pf
Output .....	3.4 Pf
<b>Diode</b>	
Input: p to (h + k).....	2.3 Pf
Cathode to (h + p) .....	3.0 Pf
<b>Coupling</b>	
Diode Plate to Pentode Plate .....	0.035 Pf
Diode Plate to Pentode Grid No. 1 .....	0.005 Pf
Diode Cathode to Pentode Plate .....	0.15 Pf

**RATINGS (Design Center Rating System)**

<b>Pentode</b>	
Plate Voltage (Max.).....	330 Volts
Plate Dissipation (Max.) .....	3.2 Watts
Grid No. 2 Voltage .....	See Rating Chart (Gen. Info. Sec.)
Grid No. 2 Supply Voltage (Max.) .....	330 Volts
Grid No. 2 Dissipation (Max.) .....	0.55 Watt
Positive Grid No. 1 Voltage (Max.) .....	0 Volt
Grid No. 3 Voltage (Max.) .....	0 Volt
Grid No. 1 Circuit Resistance	
Cathode Bias (Max.) .....	1.0 Megohm
Fixed Bias (Max.) .....	0.25 Megohm

**Diode**

Diode Current for Continuous Operation (Max.) ..... 5.0 Ma

**CHARACTERISTICS AND TYPICAL OPERATION**

<b>Pentode</b>	
Plate Voltage .....	125 Volts
Grid No. 2 Voltage .....	125 Volts
Cathode Resistor .....	56 Ohms

Plate Current .....	12.5 Ma
Grid No. 2 Current .....	3.2 Ma
Transconductance .....	7800 $\mu$ mhos
Plate Resistance (Approx.) .....	0.3 Megohm
Grid No. 1 Voltage for $I_b = 20 \mu$ a .....	-6 Volts
$I_b$ at $E_{c1} = -3$ Volts, $R_k = 0$ .....	2.0 Ma
<b>Diode</b>	
Diode Plate Voltage for Diode Current of 50 Ma <sup>(2)</sup> .....	10 Volts

**NOTES:**

- (1) Shield No. 315.
- (2) Test condition only. Operating conditions must not exceed the design center rating.

**6AN4****UHF MIXER OR AMPLIFIER****High Mu Triode**

Construction .....	Miniature T-5½
Base .....	Button 7 Pin
Basing .....	7DK
Outline .....	5-1
Maximum Diameter .....	0.750 In.
Maximum Seated Height .....	1.500 In.
Maximum Overall Height .....	1.750 In.

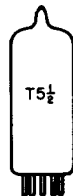
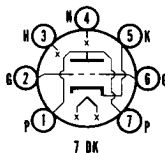
**ELECTRICAL DATA****HEATER OPERATION**

Heater Voltage.....	6.3 Volts
Heater Current .....	225 Ma
Maximum Heater-Cathode Voltage	
Heater Negative With Respect to Cathode	
Total DC and Peak.....	200 Volts
Heater Positive With Respect to Cathode	
DC .....	100 Volts
Total DC and Peak.....	200 Volts

**DIRECT INTERELECTRODE CAPACITANCES**

	Shielded <sup>(1)</sup>	Unshielded
Grid to Plate .....	1.7	1.7 Pf
Input .....	3.3	2.9 Pf
Output .....	1.8	0.25 Pf
Heater to Cathode <sup>(2)</sup> .....	2.9	3.0 Pf
Grid to Cathode <sup>(2)</sup> .....	2.6	2.6 Pf
Plate to Cathode <sup>(2)</sup> .....	0.18	0.20 Pf
<b>Grounded Grid Operation</b>		
Input .....	5.7	5.5 Pf
Output .....	3.4	1.8 Pf

**RATINGS (Design Center Rating System)**

Plate Voltage (Max.) .....	300 Volts
Plate Dissipation (Max.) .....	4 Watts
Cathode Current (Max.) .....	30 Ma
Grid Circuit Resistance	
Fixed Bias (Max.) .....	0.1 Megohm
Cathode Bias (Max.) .....	0.5 Megohm

**CHARACTERISTICS AND TYPICAL OPERATION****Class A Amplifier**

Plate Voltage .....	200 Volts
Cathode Bias Resistor .....	100 Ohms
Plate Current .....	13 Ma
Transconductance .....	10,000 $\mu$ mhos
Amplification Factor .....	70
Grid Voltage for $I_b = 20 \mu$ a .....	-7 Volts

**Mixer Service**

Plate Voltage .....	125 Volts
Cathode Bias Resistor .....	270 Ohms
Plate Current .....	7 Ma
Oscillator Injection Voltage (RMS).....	1.4 Volts
Conversion Conductance .....	2900 $\mu$ mhos

**NOTES:**

- (1) Shield No. 316.
- (2) Measured between specified elements only. When external shield is used, it shall be grounded.

# VIDEO AMPLIFIER

# 6AN5

**Beam Pentode**

Construction ..... Miniature T-5½  
 Base ..... Button 7 Pin, E7-1  
 Basing ..... 7BD  
 Outline ..... 5-2  
 Maximum Diameter ..... 0.750 In.  
 Maximum Seated Height ..... 1.875 In.  
 Maximum Overall Height ..... 2.125 In.

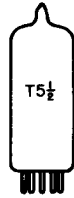
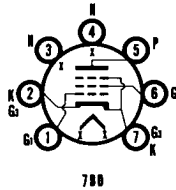

**ELECTRICAL DATA**

**HEATER OPERATION**

Heater Voltage .....  
 Heater Current .....  
 Maximum Heater-Cathode Voltage .....

6.3 Volts  
 450 Ma  
 90 Volts

**DIRECT INTERELECTRODE CAPACITANCES**

Grid No. 1 to Plate .....  
 Input .....  
 Output .....

0.075 Pf  
 9.0 Pf  
 4.8 Pf

**RATINGS (Design Center Rating System)**

Plate Voltage (Max.) ..... 120  
 Grid No. 2 Voltage (Max.) ..... 120  
 Cathode Current (Max.) ..... 50  
 Plate Dissipation (Max.) ..... 4.2  
 Grid No. 2 Dissipation (Max.) ..... 1.4  
 Grid No. 1 Circuit Resistance  
     Fixed Bias (Max.) ..... 0.1  
     Cathode Bias (Max.) ..... 0.1

300 Volts  
 300 Volts  
 20 Ma  
 1.7 Watts  
 0.56 Watts  
 0.1 Megohm  
 0.1 Megohm

**CHARACTERISTICS AND TYPICAL OPERATION**

Plate Voltage .....  
 Grid No. 2 Voltage .....  
 Cathode Resistor .....  
 Plate Current .....  
 Grid No. 2 Current .....  
 Plate Resistance .....  
 Transconductance .....  
 Load Resistance .....  
 Power Output (Approx.) .....  
 Plate Current for  $I_b = 1$  Ma .....

120 Volts  
 120 Volts  
 120 Ohms  
 35 Ma  
 12 Ma  
 12,500 Ohms  
 8000  $\mu$ mhos  
 2500 Ohms  
 1.3 Watts  
 -20 Volts

**AVERAGE PLATE CHARACTERISTICS**

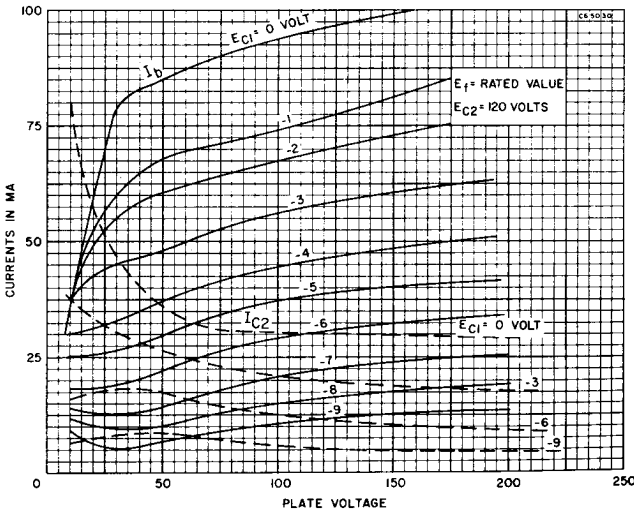

# 6AN8A

5AN8

Color Television Type

## OSC./SYNC SEP./SYNC CLIPPER (T) IF/VIDEO/AGC AMPLIFIER (P)

**Medium Mu Triode and Sharp Cutoff Pentode**

Construction ..... Miniature T-6½  
 Base ..... Button 9 Pin, E9-1  
 Basing ..... 9DA  
 Outline ..... 6-2  
     Maximum Diameter ..... 0.875 In.  
     Maximum Seated Height ..... 1.938 In.  
     Maximum Overall Height ..... 2.188 In.

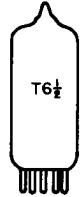
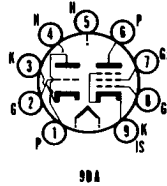

**ELECTRICAL DATA  
HEATER OPERATION**

	<b>5AN8 Series</b>	<b>6AN8A Series</b>
Heater Voltage .....	4.7	6.3 Volts
Heater Current .....	600	450 Ma
Heater Warm-up Time .....	11	11 Seconds
Maximum Heater-Cathode Voltage		
Heater Negative With Respect to Cathode		
Total DC and Peak .....		200 Volts
Heater Positive With Respect to Cathode		
DC .....		100 Volts
Total DC and Peak .....		200 Volts

**DIRECT INTERELECTRODE CAPACITANCES**

**Triode Section**

Grid to Plate .....	1.5 Pf
Input: gto (h + k) .....	2.0 Pf
Output: p to (h + k) .....	0.26 Pf

**Pentode Section**

Grid No. 1 to Plate (Max.) .....	0.04 Pf
Input: g1 to (h + k + g2 + g3 + IS) .....	7.0 Pf
Output: p to (h + k + g2 + g3 + IS) .....	2.4 Pf

**Coupling**

Triode Grid to Pentode Plate (Max.) .....	0.02 Pf
Pentode Grid No. 1 to Triode Plate (Max.) .....	0.02 Pf
Pentode Plate to Triode Plate (Max.) .....	0.15 Pf

**RATINGS (Design Maximum Rating System)**

	<b>Triode Section</b>	<b>Pentode Section</b>
Plate Voltage (Max.) .....	330	330 Volts
Grid No. 2 Supply Voltage (Max.) .....	—	330 Volts
Grid No. 2 Voltage .....	See Rating Chart (Gen. Info. Sec.)	
Grid No. 1 Voltage		
Positive Bias Value (Max.) .....	0	0 Volt
Plate Dissipation (Max.) .....	2.8	2.3 Watts
Grid No. 2 Input (Max.) .....	—	0.55 Watt
Grid No. 1 Circuit Resistance <sup>(1)</sup>		
Fixed Bias (Max.) .....	0.5	0.25 Megohm
Cathode Bias (Max.) .....	1.0	1.0 Megohm

**CHARACTERISTICS AND TYPICAL OPERATION**

	<b>Triode Section</b>	<b>Pentode Section</b>
Plate Supply Voltage .....	150	125 Volts
Grid No. 2 Supply Voltage .....	—	125 Volts
Grid No. 1 Voltage .....	-3	— Volts
Cathode Bias Resistor .....	—	56 Ohms
Plate Current .....	15	12 Ma
Grid No. 2 Current .....	—	3.8 Ma
Transconductance .....	4500	7800 μmhos
Amplification Factor .....	21	—
Plate Resistance (Approx.) .....	4700	170,000 Ohms
Ec1 for Ib = 20 μa (Approx.) .....	-17	-6 Volts
Ib with Ec1 = -3 Volts, Rk = 0 .....	—	1.6 Ma

**NOTE:**

(1) If either section is operating at maximum rated conditions, the Grid No. 1 circuit resistance for both sections should not exceed the stated values.

**AVERAGE PLATE CHARACTERISTICS  
(Triode Section)**

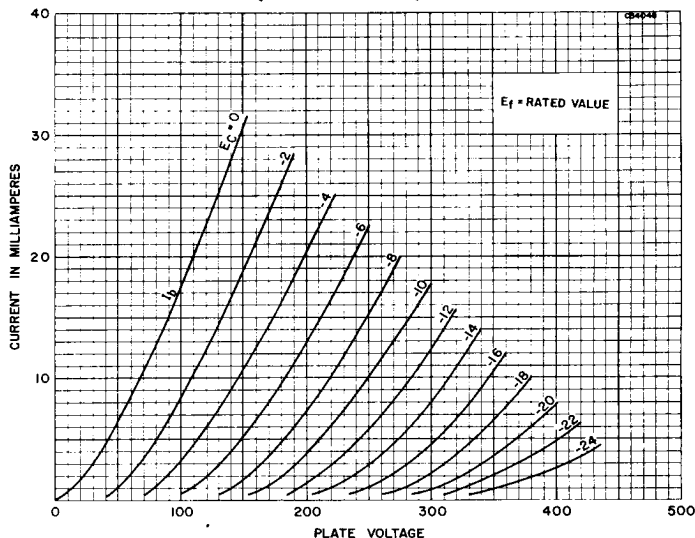

Color Television Type  
**AUDIO POWER AMPLIFIER  
 or VERTICAL DEFLECTION AMP.**

**6AQ5A**  
 5AQ5, 12AQ5, 19AQ5

**Beam Power Pentode**

- Construction ..... Miniature T-5½
- Base ..... Button 7 Pin, E7-1
- Basing ..... 7BZ
- Outline ..... 5-3
- Maximum Diameter ..... 0.750 In.
- Maximum Seated Height ..... 2.375 In.
- Maximum Overall Height ..... 2.625 In.

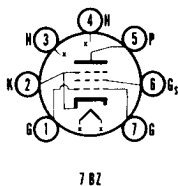

**ELECTRICAL DATA  
 HEATER OPERATION**

	19AQ5	12AQ5	5AQ5	6AQ5A
Heater Voltage.....	18.9	12.6	4.7	6.3 Volts
Heater Current .....	150	225	600	450 Ma
Heater Warm-up Time .....	—	—	11	11 Seconds
Maximum Heater-Cathode Voltage				
Heater Negative with Respect to Cathode				200 Volts
Total DC and Peak.....				
Heater Positive with Respect to Cathode				100 Volts
DC .....				200 Volts
Total DC and Peak.....				

**DIRECT INTERELECTRODE CAPACITANCES**

Grid to Plate .....	0.4 Pf
Input: g1 to (h + k + g2 + g3) .....	8.0 Pf
Output: p to (h + k + g2 + g3) .....	8.5 Pf

**RATINGS (Design Maximum Rating System)**

**Class A1 Amplifier**

Plate Voltage (Max.) .....	275 Volts
Grid No. 2 Voltage (Max.) .....	275 Volts
Plate Dissipation (Max.) .....	12 Watts
Grid No. 2 Dissipation (Max.) .....	2 Watts
Grid No. 1 Circuit Resistance	
Fixed Bias (Max.) .....	0.1 Megohm
Cathode Bias (Max.) .....	0.5 Megohm
Bulb Temperature (At Any Point) (Max.) .....	250 °C

**Vertical Deflection Amplifier<sup>(1)</sup>—Triode Connected<sup>(2)</sup>**

Plate Voltage (Max.) .....	275 Volts
Peak Positive Plate Voltage (Abs. Max.) .....	1100 Volts
Plate Dissipation (Max.) <sup>(3)</sup> .....	10 Watts
Peak Negative Grid No. 1 Voltage (Max.) .....	275 Volts
Average Cathode Current (Max.) .....	40 Ma
Peak Cathode Current (Max.) .....	115 Ma
Grid No. 1 Circuit Resistance .....	
Cathode Bias (Max.) .....	2.2 Megohms

**CHARACTERISTICS AND TYPICAL OPERATION**

	<b>Triode Conn.</b>	<b>Pentode Conn.</b>	
<b>Class A1 Amplifier</b>			
Plate Voltage .....	250	180	250 Volts
Grid No. 2 Voltage .....	—	180	250 Volts
Grid No. 1 Voltage .....	-12.5	-8.5	-12.5 Volts
Peak AF Grid No. 1 Voltage .....	—	8.5	12.5 Volts
Zero-Signal Plate Current .....	49.5	29	45 Ma
Maximum Signal Plate Current .....	—	30	47 Ma
Zero-Signal Grid No. 2 Current .....	—	3	4.5 Ma
Maximum Signal Grid No. 2 Current .....	—	4	7.0 Ma
Plate Resistance (Approx.) .....	1970	58,000	52,000 Ohms
Transconductance .....	4800	3700	4100 $\mu$ mhos
Load Resistance .....	—	5500	5000 Ohms
Maximum Signal Power Output .....	—	2.0	4.5 Watts
Total Harmonic Distortion (Approx.) .....	—	8	8 Percent
Ec1 for Ib = 0.5 Ma (Approx.) .....	-37	—	— Volts

**NOTES:**

- (1) For operation in a 525 line, 30 frame system as described in "Standards of Good Engineering Practice for Television Broadcast Stations; Federal Communications Commission," the duty cycle of the voltage pulse must not exceed 15% of one horizontal scanning cycle.
- (2) Grid No. 2 connected to plate.
- (3) In stages operating with grid leak bias, an adequate cathode bias resistor or other suitable means is required to protect the tube in the absence of excitation.

**6AQ6**

**AF AMPLIFIER AND DETECTOR**

**Double Diode and High Mu Triode**

Construction .....	Miniature T-5 $\frac{1}{2}$
Base .....	Button 7 Pin, E7-1
Basing .....	.7BT
Outline .....	5-2
Maximum Diameter .....	0.750 In.
Maximum Seated Height .....	1.875 In.
Maximum Overall Height .....	2.125 In.

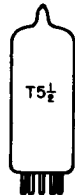
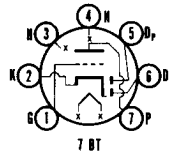

**ELECTRICAL DATA**

**HEATER OPERATION**

Heater Voltage .....	6.3 Volts
Heater Current .....	150 Ma
Maximum Heater Cathode Voltage .....	90 Volts

**DIRECT INTERELECTRODE CAPACITANCES (Shielded)<sup>(1)</sup>**

Grid to Plate .....	1.8 Pf
Input .....	1.7 Pf
Output .....	1.5 Pf

**RATINGS (Design Center Rating System)**

**Triode**

Plate Voltage (Max.) .....	300 Volts
Positive Grid No. 1 Voltage (Max.) .....	0 Volt

**Diode**

Diode Operating Current Per Plate (Max.) .....	0.9 Ma
--	--------

**CHARACTERISTICS AND TYPICAL OPERATION**

**Class A1 Amplifier**

Plate Voltage .....	100	250 Volts
Grid No. 1 Voltage <sup>(2)</sup> .....	-1	-3 Volts
Plate Resistance (Approx.) .....	61,000	58,000 Ohms
Transconductance .....	1150	1200 $\mu$ mhos
Plate Current .....	0.8	1.0 Ma

**NOTES:**

- (1) Shield No. 316 connected to cathode.
- (2) Diode biasing of the triode section is not recommended.



Color Television Type  
**RF AMPLIFIER AND MIXER**

**6AQ8/ECC85**  
9AQ8

**High Mu Twin Triode**

Construction ..... Miniature T-6½  
 Base ..... Button 9 Pin, E9-1  
 Basing<sup>(1,2)</sup> ..... 9AJ  
 Outline ..... 6-2  
 Maximum Diameter ..... 0.875 In.  
 Maximum Seated Height ..... 1.937 In.  
 Maximum Overall Height ..... 2.187 In.

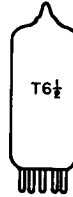
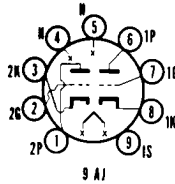

**ELECTRICAL DATA**

**HEATER OPERATION**

	<b>6AQ8</b>	<b>6AQ8/ECC85</b>
Heater Voltage.....	9.0	6.3 Volts
Heater Current .....	300	435 Ma
Maximum Heater-Cathode Voltage .....	90	90 Volts

**DIRECT INTERELECTRODE CAPACITANCES**

	Section No. 1	Section No. 2
Grid to Plate .....	1.5	1.5 Pf
Input: g to (k + h + IS) .....	3.0	3.0 Pf
Output: p to (k + h + IS) .....	1.2	1.2 Pf

**RATINGS (Design Center Rating System) (Each Section)**

Plate Voltage (Max.) .....	300 Volts
Plate Dissipation (Max.) .....	2.5 Watts
Cathode Current (Max.).....	15 Ma
Negative Grid Voltage (Max.).....	100 Volts
Grid Circuit Resistance (Max.) .....	1.0 Megohms

**CHARACTERISTICS AND TYPICAL OPERATION**

	R-F Amp	Autodyne Osc/Mixer
Plate Supply Voltage.....	— 250	250 Volts
Plate Dropping Resistor .....	— 1800	12,000 Ohms
Plate Voltage .....	250 230	— Volts
Grid Voltage .....	-2.3 -2.0	— Volts
Cathode Resistor .....	— 200	— Ohms
Grid Leak Resistor.....	— —	1.0 Megohms
Oscillator Voltage (RMS).....	— —	3 Volts
Plate Current .....	10 10	5.2 Ma
Transconductance .....	5900 6000	— μmhos
Conversion Transconductance .....	— —	2300 μmhos
Amplification Factor .....	57 —	—
Plate Resistance.....	— 9700	22,000 Ohms
Input Resistance.....	— 6000	15,000 Ohms
Equivalent Noise Resistance .....	— 500	— Ohms

**NOTES:**

- (1) Section No. 1 connects to Pins 6, 7, and 8.
- (2) An internal shield is connected to Pin No. 9 to provide isolation between the two sections.

**IF AMPLIFIER**

**6AR11**  
8AR11, 11AR11

**Twin Pentode**

Construction ..... Compactron T-9  
 Base ..... Button 12 Pin, E12-70  
 Basing ..... 12DM  
 Outline ..... 9-58  
 Maximum Diameter ..... 1.188 In.  
 Maximum Seated Height ..... 2.000 In.  
 Maximum Overall Height ..... 2.375 In.

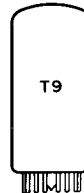
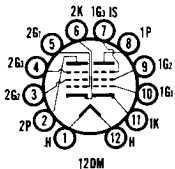

**ELECTRICAL DATA**

**HEATER OPERATION**

	<b>11AR11</b>	<b>8AR11</b>	<b>6AR11</b>
Heater Voltage.....	11.2	8.4	6.3 Volts
Heater Current .....	450	600	800 Ma
Heater Warm-up Time .....	11	11	— Seconds
<b>Maximum Heater-Cathode Voltage</b>			
Heater Negative with Respect to Cathode			
Total DC and Peak.....			200 Volts
Heater Positive with Respect to Cathode			
DC .....			100 Volts
Total DC and Peak.....			200 Volts

**DIRECT INTERELECTRODE CAPACITANCES (Shielded)<sup>(1)</sup>**

**Section 1**

Grid-Number 1 to Plate .....	0.026 Pf
Input: 1g1 to (1k + 1g2 + 1g3 + h + IS).....	10 Pf
Output: 1p to (1k + 1g2 + 1g3 + h + IS).....	2.8 Pf

**Section 2**

Grid-Number 1 to Plate .....	0.026 Pf
Input: 2g1 to (2k + 2g2 + 2g3 + 1g3 + h + IS) .....	10 Pf
Output: 2p to (2k + 2g2 + 2g3 + 1g3 + h + IS) .....	3.0 Pf
Plate to Plate (Max.).....	0.016 Pf
Grid-Number 1, Section 1 to Plate, Section 2:(Max.) .....	0.002 Pf
Grid-Number 1, Section 2 to Plate, Section 1: (Max.) .....	0.004 Pf

**RATINGS (Design Maximum Rating System) (Each Section)**

Plate Voltage (Max.) .....	330 Volts
Suppressor Voltage (Max.).....	0 Volt
Screen-Supply Voltage (Max.) .....	330 Volts
Screen Voltage.....	See Rating Chart (Gen. Info. Sec.)
Positive DC Grid No. 1 Voltage (Max.) .....	0 Volt
Plate Dissipation (Max.) .....	3.1 Watts
Screen Dissipation (Max.) .....	0.65 Watt

**CHARACTERISTICS AND TYPICAL OPERATION (Each Section)**

Plate Voltage .....	125 Volts
Suppressor .....	Connected to Cathode at Socket
Screen Voltage.....	125 Volts
Cathode-Bias Resistor .....	56 Ohms
Plate Resistance (Approx.) .....	0.2 Megohms
Transconductance .....	10,500 $\mu$ mhos
Plate Current .....	11 Ma
Screen Current .....	3.5 Ma
Grid No. 1 Voltage (Approx.) .....	
$G_m = 50 \mu$ mhos .....	-15 Volts

**NOTE:**

(1) With external shield (EIA 309) connected to cathode of section under test.

**6AS5**

**AUDIO POWER AMPLIFIER**

**Beam Pentode**

Construction .....	Miniature T-5½
Base .....	Button 7 Pin
Biasing .....	.7CV
Outline .....	5-3
Maximum Diameter .....	0.750 In.
Maximum Seated Height .....	2.375 In.
Maximum Overall Height .....	2.625 In.

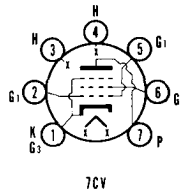

**ELECTRICAL DATA**

**HEATER OPERATION**

Heater Voltage.....	6.3 Volts
Heater Current .....	800 Ma
Maximum Heater-Cathode Voltage .....	100 Volts

**DIRECT INTERELECTRODE CAPACITANCES**

Grid to Plate .....	0.6 Pf
Input .....	12 Pf
Output .....	9.0 Pf

**RATINGS (Design Center Rating System)**

Plate Voltage (Max.) .....	150 Volts
Grid No. 2 Voltage (Max.) .....	117 Volts
Plate Dissipation (Max.) .....	5.5 Watts
Grid No. 2 Dissipation (Max.) .....	1.0 Watt
Grid No. 1 Circuit Resistance	
Fixed Bias (Max.) .....	0.1 Megohm
Cathode Bias (Max.) .....	0.5 Megohm

**CHARACTERISTICS AND TYPICAL OPERATION**

**Class A1 Amplifier**

Plate Voltage .....	150 Volts
Grid No. 2 Voltage .....	110 Volts
Grid No. 1 Voltage .....	8.5 Volts
Peak AF Grid No. 1 Voltage .....	8.5 Volts
Plate Current (Zero Signal) .....	35 Ma
Plate Current (Maximum Signal) .....	36 Ma
Grid No. 2 Current (Zero Signal) .....	2 Ma
Grid No. 2 Current (Maximum Signal) .....	6.5 Ma
Transconductance .....	5600 $\mu$ mhos
Load Resistance .....	4500 Ohms
Total Harmonic Distortion .....	10 Percent
Maximum Signal Power Output .....	2.2 Watts

*Color Television Type*

**AUDIO/VIDEO DETECTOR or DC RESTORER (D) IF/VIDEO/AGC AMPLIFIER (P)**

**6AS8**

5AS8

**High Perveance Diode and Sharp Cutoff Pentode**

Construction .....	Miniature T-6½
Base .....	Button 9 Pin, E9-1
Basing .....	9DS
Outline .....	6-2
Maximum Diameter .....	0.875 In.
Maximum Seated Height .....	1.937 In.
Maximum Overall Height .....	2.187 In.

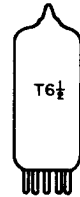
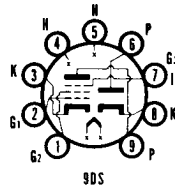

**ELECTRICAL DATA**

**HEATER OPERATION**

	<b>5AS8 Series</b>	<b>6AS8 Parallel</b>
Heater Voltage .....	4.7	6.3 Volts
Heater Current .....	600	450 Ma
Heater Warm-up Time .....	11	— Seconds
Maximum Heater-Cathode Voltage		
Heater Negative With Respect to Cathode		200 Volts
Heater Positive With Respect to Cathode		
DC .....		100 Volts
Total DC and Peak .....		200 Volts

**DIRECT INTERELECTRODE CAPACITANCES (Unshielded)**

**Pentode Section**

Grid No. 1 to Plate (Max.) .....	0.03 Pf
Input: g1 to (h + k + g2 + g3) .....	7.0 Pf
Output: p to (h + k + g2 + g3) .....	2.4 Pf

**Coupling**

Pentode Grid to Diode Plate (Max.) .....	0.005 Pf
Pentode Plate to Diode Cathode (Max.) .....	0.15 Pf
Pentode Plate to Diode Plate (Max.) .....	0.10 Pf

**Diode Section**

Plate to Heater, Cathode and Internal Shield .....	3.0 Pf
--	--------

**RATINGS (Design Center Rating System)**

**Pentode Section**

Plate Voltage (Max.) .....	300 Volts
Plate Dissipation (Max.) .....	2.5 Watts
Grid No. 2 Voltage .....	See Rating Chart (Gen. Info. Sec.)
Grid No. 2 Supply Voltage (Max.) .....	300 Volts
Grid No. 2 Dissipation (Max.) .....	0.5 Watt
Positive Grid No. 1 Voltage (Max.) .....	0 Volt
Grid No. 3 Voltage (Max.) .....	0 Volt

Grid No. 1 Circuit Resistance	
Cathode Bias (Max.) .....	1.0 Megohm
Fixed Bias (Max.) .....	0.25 Megohm

**Diode Section**

Peak Inverse Plate Voltage (Max.) .....	330 Volts
Peak Plate Current (Max.) .....	50 Ma
DC Plate Current (Max.) .....	5 Ma

**CHARACTERISTICS AND TYPICAL OPERATION**

**Class A1 Amplifier**

Plate Supply Voltage.....	200 Volts
Grid No. 2 Supply Voltage.....	150 Volts
Grid No. 3 Voltage .....	Connected to Cathode at Socket
Cathode Resistor .....	180 Ohms
Plate Current .....	9.5 Ma
Grid No. 2 Current .....	3.0 Ma
Transconductance .....	6200 $\mu$ mhos
Plate Resistance (Approx.) .....	0.3 Megohm
Grid No. 1 Voltage for $I_b = 10 \mu$ a (Approx.) .....	-8 Volts



**Medium Mu Triode, High Mu Triode and Sharp Cutoff Pentode**

Construction.....	Compactron T-9
Base .....	Button 12 Pin, E12-70
Basing .....	12DP
Outline .....	9-58
Maximum Diameter .....	1.188 In.
Maximum Seated Height .....	2.000 In.
Maximum Overall Height .....	2.375 In.

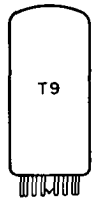
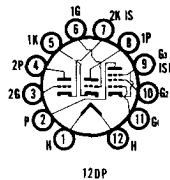

**ELECTRICAL DATA**

**HEATER OPERATION**

Heater Voltage.....	6.3 Volts
Heater Current .....	1050 Ma
Maximum Heater-Cathode Voltage	
Heater Negative With Respect to Cathode	
Total DC and Peak.....	200 Volts
Heater Positive With Respect to Cathode	
DC .....	100 Volts
Total DC and Peak.....	200 Volts

**DIRECT INTERELECTRODE CAPACITANCES**

**Triode (Section 1)**

Grid to Plate .....	1.9 Pf
Input: T1g to (T1k + T2k + Pk + Pg3 + IC + IS).....	3.0 Pf
Output: T1p to (T1k + T2k + Pk + Pg3 + IC + IS).....	2.2 Pf

**Triode (Section 2)**

Grid to Plate.....	3.6 Pf
Input: T2g to (T2k + Pk + Pg3 + IC + IS) .....	2.4 Pf
Output: T2p to (T2k + Pk + Pg3 + IC + IS) .....	3.8 Pf

**Pentode**

Grid 1 to Plate .....	0.11 Pf
Input: Pg1 to (T2k + Pk + Pg2 + Pg3 + IC + IS) .....	9.5 Pf
Output: Pp to (T2k + Pk + Pg2 + Pg3 + IC + IS) .....	4.4 Pf

**Coupling**

Pentode Plate to Triode Plate (Section 2) (Max.) .....	0.044 Pf
Triode Plate (Section 1) to Triode Plate (Section 2) (Max.) .....	0.06 Pf

**RATINGS (Design Maximum Rating System)**

**Triode (Section 1)**

Plate Voltage (Max.) .....	330 Volts
Positive DC Grid Voltage (Max.) .....	0 Volt
Plate Dissipation (Max.) .....	1.5 Watts
Grid No. 1 Circuit Resistance	
Fixed Bias (Max.) .....	0.5 Megohm
Cathode Bias (Max.) .....	1.0 Megohm

**Triode (Section 2)**

Plate Voltage (Max.) .....	330 Volts
Positive DC Grid Voltage (Max.) .....	0 Volt
Plate Dissipation (Max.) .....	2.0 Watts
Grid 1 Circuit Resistance	
Fixed Bias (Max.) .....	0.5 Megohm
Cathode Bias (Max.) .....	1.0 Megohm

**Pentode Section**

Plate Voltage (Max.) .....	330 Volts
Screen Supply Voltage (Max.) .....	330 Volts
Screen Voltage .....	See Rating Chart (Gen. Info. Sec.)
Positive DC Grid Voltage (Max.) .....	0 Volt
Plate Dissipation (Max.) .....	5.0 Watts
Screen Dissipation (Max.) .....	1.1 Watts
Grid 1 Circuit Resistance	
Fixed Bias (Max.) .....	0.25 Megohm
Cathode Bias (Max.) .....	1.0 Megohm

**CHARACTERISTICS AND TYPICAL OPERATION**

**Triode (Section 1)**

Plate Voltage .....	200 Volts
Grid Voltage .....	-2.0 Volts
Plate Current .....	7.0 Ma
Transconductance .....	5500 $\mu$ mhos
Plate Resistance (Approx.) .....	12,400 Ohms
Amplification Factor .....	68
Grid Voltage for $I_b = 10 \mu$ a .....	-5.5 Volts

**Triode (Section 2)**

Plate Voltage .....	200 Volts
Cathode Bias Resistor .....	220 Ohms
Plate Current .....	9.2 Ma
Transconductance .....	4400 $\mu$ mhos
Plate Resistance (Approx.) .....	9400 Ohms
Amplification Factor .....	41
Grid Voltage for $I_b = 100 \mu$ a .....	-6.5 Volts

**Pentode Section**

Plate Voltage .....	200 Volts
Screen Voltage .....	125 Volts
Cathode Bias Resistor .....	68 Ohms
Plate Current .....	24 Ma
Screen Current .....	5.2 Ma
Transconductance .....	10,500 $\mu$ mhos
Plate Resistance (Approx.) .....	70,000 Ohms
Grid 1 Voltage for $I_b = 10 \mu$ a .....	-8 Volts

*Color Television Type*  
**AF AMPLIFIER AND DETECTOR**

**6AT6**  
12AT6

**Double Diode and High Mu Triode**

Construction .....	Miniature T-5½
Base .....	Butt-on 7 Pin
Basing .....	7BT
Outline .....	5-2
Maximum Diameter .....	0.750 In.
Maximum Seated Height .....	1.875 In.
Maximum Overall Height .....	2.125 In.

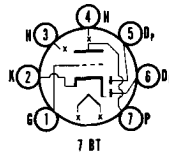

**ELECTRICAL DATA**

**HEATER OPERATION**

	12AT6	6AT6
Heater Voltage .....	12.6	6.3 Volts
Heater Current .....	150	300 Ma
Maximum Heater-Cathode Voltage .....	90	90 Volts

**DIRECT INTERELECTRODE CAPACITANCES**

	Shielded (1)	Unshielded
Grid to Plate .....	2.0	2.0 Pf
Input: g to (h + k) .....	2.2	2.2 Pf
Output: p to (h + k) .....	1.2	0.8 Pf
Diode Plate No. 2 to Grid (Max.) .....	0.04	0.04 Pf

**RATINGS (Design Maximum Rating System)**

**Triode**

Plate Voltage (Max.) .....	300 Volts
Plate Dissipation (Max.) .....	0.5 Watt
Positive-Grid Voltage (Max.) .....	0 Volt

**Diode**

Diode Current (Each Section) (Max.) .....	1.0 Ma
---	--------

**CHARACTERISTICS AND TYPICAL OPERATION**

**Class A1 Amplifier**

Plate Voltage .....	100	250 Volts
Grid Voltage .....	-1	-3 Volts
Plate Current .....	0.8	1.0 Ma
Transconductance .....	1300	1200 $\mu$ mhos
Amplification Factor .....	70	70
Plate Resistance .....	54,000	58,000 Ohms
Average Diode Current at 10 Volts DC <sup>(2)</sup> .....	2.0	2.0 Ma

**NOTES:**

- (1) Shield No. 316 connected to cathode.
- (2) Test condition only.



**Medium Mu Triode and Sharp Cutoff Pentode**

Construction ..... Miniature T-6½  
 Base ..... Button 9 Pin, E9-1  
 Basing ..... 9DW  
 Outline ..... 6-2  
 Maximum Diameter ..... 0.875 In.  
 Maximum Seated Height ..... 1.938 In.  
 Maximum Overall Height ..... 2.188 In.

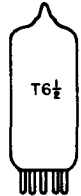
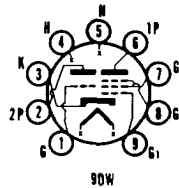

**ELECTRICAL DATA**

**HEATER OPERATION**

	<b>5AT8</b>	<b>6AT8A</b>
Heater Voltage .....	4.7	6.3 Volts
Heater Current .....	600	450 Ma
Heater Warm-up Time .....	11	11 Seconds
Maximum Heater-Cathode Voltage		
Heater Negative With Respect to Cathode		
Total DC and Peak .....		200 Volts
Heater Positive With Respect to Cathode		
DC .....		100 Volts
Total DC and Peak .....		200 Volts

**DIRECT INTERELECTRODE CAPACITANCES**

	<b>Shielded<sup>(1)</sup></b>	<b>Unshielded</b>
<b>Triode Section</b>		
Grid to Plate .....	1.5	1.5 Pf
Input .....	2.4	2.0 Pf
Output .....	1.0	0.5 Pf
<b>Pentode Section</b>		
Grid No. 1 to Plate (Max.) .....	0.016	0.025 Pf
Input .....	4.7	4.5 Pf
Output .....	1.6	0.9 Pf
<b>Pentode Section Triode Connected<sup>(2)</sup></b>		
Grid No. 1 to Plate .....	1.3	1.3 Pf
Input .....	3.3	3.0 Pf
Output .....	2.5	1.7 Pf
<b>Coupling</b>		
Pentode Grid No. 1 to Triode Plate (Max.) .....	0.04	0.05 Pf
Pentode Plate to Triode Plate (Max.) .....	0.007	0.05 Pf
Heater to Cathode .....	6.5 <sup>(3)</sup>	6.5 Pf

**RATINGS (Design Center Rating System)**

	Triode Section as Oscillator	Pentode Section as Mixer
<b>Converter Service</b>		
Plate Voltage (Max.) .....	250	250 Volts
Grid No. 3 Voltage (Max.) .....	—	0 Volt
Grid No. 2 Supply Voltage (Max.) .....	—	250 Volts
Grid No. 2 Voltage .....	See Rating Chart (Gen. Info. Sec.)	
Grid No. 1 Voltage		
Negative Bias Value (Max.) .....	40	40 Volts
Positive Bias Value (Max.) .....	0	0 Volt
Plate Dissipation (Max.) .....	1.5	2.0 Watts
Grid No. 2 Input (Max.) .....	—	0.4 Watt
Grid No. 1 Input (Max.) .....	0.5	— Watt
Grid No. 1 Circuit Resistance		
Fixed Bias (Max.) .....	—	0.1 Megohm
Self Bias (Max.) .....	—	0.5 Megohm

**Pentode Section as Triode Connected Mixer<sup>(2)</sup>**

Plate Voltage (Max.) .....	250 Volts
Negative Grid No. 1 Voltage (Max.) .....	40 Volts
Positive Grid No. 1 Voltage (Max.) .....	0 Volt
Plate Dissipation (Max.) .....	2.4 Watts

**CHARACTERISTICS AND TYPICAL OPERATION**

	Triode Section	Pentode Section
Plate Voltage .....	100	250 Volts
Grid No. 3 Voltage .....	Connected to Cathode at Socket	
Grid No. 2 Voltage .....	—	150 Volts
Cathode Bias Resistor .....	100	200 Ohms
Plate Current .....	8.5	7.7 Ma
Grid No. 2 Current .....	—	1.6 Ma
Transconductance .....	5800	4600 $\mu$ mhos
Amplification Factor .....	40	—
Plate Resistance (Approx.) .....	6900	750,000 Ohms
Ec1 for Ib = 10 $\mu$ a (Approx.) .....	-10	-10 Volts

	Triode Section as 250 MHz Oscillator <sup>(4)</sup>	Pentode Section as Mixer <sup>(5)</sup>
Plate Voltage .....	150	150 Volts
Grid No. 3 Voltage .....	Connected to Cathode at Socket	
Grid No. 2 Voltage .....	—	150 Volts
Mixer Grid No. 1 Supply Voltage .....	—	-3.5 Volts
Plate Current .....	13	6.2 Ma
Grid No. 2 Current .....	—	1.8 Ma
Conversion Transconductance .....	—	2100 $\mu$ mhos
Mixer Grid No. 1 Circuit Resistance .....	—	120,000 Ohms
Oscillator Voltage at Mixer Grid No. 1 (RMS) .....	—	2.6 Volts
Oscillator Grid Resistor .....	2700	— Ohms
Grid No. 1 Current .....	3.6	— Ma
Grid No. 1 Current .....	—	2.0 $\mu$ a
Oscillator Power Output (Approx.) <sup>(4)</sup> .....	0.5	— Watt

**Pentode Section as Triode Connected Mixer<sup>(2)</sup>**

Plate Voltage .....	150 Volts
Grid No. 1 Supply Voltage .....	-3.5 Volts
Plate Current .....	7.8 Ma
Conversion Transconductance .....	2800 $\mu$ mhos
Oscillator Voltage at Grid No. 1 (RMS) .....	2.6 Volts
Grid No. 1 Current .....	2.0 $\mu$ a
Grid No. 2 Circuit Resistance .....	120,000 Ohms

**NOTES:**

- (1) External Shield No. 315 connected to cathode.
- (2) Grid No. 3 connected to cathode; Grid No. 2 connected to plate.
- (3) Shield No. 315 connected to ground.
- (4) In TV or FM receivers, it is generally desirable to operate the oscillator with less power input than shown in the tabulation data in order to avoid over excitation and excessive oscillator radiation.
- (5) With separate excitation and triode unit grounded.

**6AU4GTA**  
19AU4GTA

Color Television Type  
**DAMPER**

**Heater-Cathode Diode**

Construction .....Octal T-9  
Base<sup>(1)</sup> .....Octal 5 or 6 Pin, B5-85 or B6-60  
Basing<sup>(1)</sup> .....4CG  
Outline .....9-44  
Maximum Diameter .....1.188 In.  
Maximum Seated Height .....3.250 In.  
Maximum Overall Height .....3.813 In.

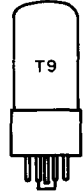
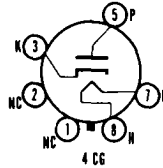

**ELECTRICAL DATA**  
**HEATER OPERATION**

	19AU4GTA	6AU4GTA
Heater Voltage.....	18.9	6.3 Volts
Heater Current.....	600	1800 Ma
Heater Warm-up Time.....	11	— Seconds
Maximum Heater-Cathode Voltage		
Heater Negative with Respect to Cathode		
DC.....		900 Volts
Total DC and Peak.....		4500 Volts
Heater Positive with Respect to Cathode		
DC.....		100 Volts
Total DC and Peak.....		300 Volts

**DIRECT INTERELECTRODE CAPACITANCES (Unshielded)**

Heater to Cathode.....	4.0 Pf
Plate to Cathode and Heater.....	8.5 Pf
Cathode to Plate and Heater.....	11.5 Pf

**RATINGS (Design Maximum Rating System)**

**Damper Diode<sup>(2)</sup>**

Peak Inverse Plate Voltage (Abs. Max.).....	4500 Volts
DC Plate Current (Max.).....	190 Ma
Steady State Peak Plate Current (Max.).....	1150 Ma
Plate Dissipation (Max.).....	6.0 Watts

**CHARACTERISTICS AND TYPICAL OPERATION**

**Damper Service—90° Deflection Scan System**

Peak Inverse Plate Voltage.....	3.65 Kv
Peak Heater-Cathode Voltage.....	3.9 Kv
Average Cathode Current.....	120 Ma
Peak Cathode Current.....	500 Ma
Boosted B+ Voltage.....	640 Volts
Plate Dissipation.....	2.8 Watts
Average Tube Voltage Drop for Ib = 350 Ma.....	25 Volts

**NOTES:**

- (1) May be either 5 or 6 pin. Socket terminals No. 1 (if used), 2, 4, and 6 shall not be used as tie points. Pin No. 1 may be omitted on 5 pin base.
- (2) For operation in a 525-line, 30-frame system, the duty cycle of the horizontal voltage pulse must not exceed 15% of one horizontal scanning cycle. Power rectification service is not recommended.

**6AU6A**

3AU6, 4AU6, 12AU6

Color Television Type  
**RF AMPLIFIER**

**Sharp Cutoff Pentode**

Construction .....Miniature T-5½  
Base .....Button 7 Pin, E7-1  
Basing .....7BK  
Outline .....5-2  
Maximum Diameter .....0.750 In.  
Maximum Seated Height .....1.875 In.  
Maximum Overall Height .....2.125 In.

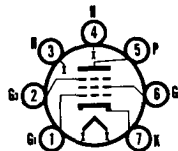

7BK



**ELECTRICAL DATA  
HEATER OPERATION**

	3AU6	4AU6	12AU6	6AU6A
Heater Voltage.....	3.15	4.2	12.6	6.3 Volts
Heater Current.....	600	450	150	300 Ma
Heater Warm-up Time.....	11	11	—	11 Seconds
Maximum Heater-Cathode Voltage				
Heater Negative with Respect to Cathode				
Total DC and Peak.....				200 Volts
Heater Positive with Respect to Cathode				
DC.....				100 Volts
Total DC and Peak.....				200 Volts

**DIRECT INTERELECTRODE CAPACITANCES (Unshielded)**

Grid to Plate (Max.).....	0.0035 Pf
Input.....	5.5 Pf
Output.....	5.0 Pf

**RATINGS (Design Maximum Rating System)**

Plate Voltage (Max.).....	330 Volts
Grid No. 2 Supply Voltage (Max.).....	330 Volts
Grid No. 2 Voltage.....	See Rating Chart (Gen. Info. Sec.)
Plate Dissipation (Max.).....	3.5 Watts
Grid No. 2 Dissipation (Max.).....	0.75 Watts
Positive Grid No. 1 Voltage (Max.).....	0 Volt

**CHARACTERISTICS AND TYPICAL OPERATION**

Plate Voltage.....	100	250	250 Volts
Grid No. 3 Voltage.....	Connected to Cathode at Socket		
Grid No. 2 Voltage.....	100	125	150 Volts
Cathode Bias Resistor.....	150	100	68 Ohms
Plate Current.....	5.0	7.6	10.6 Ma
Grid No. 2 Current.....	2.1	3.0	4.3 Ma
Transconductance.....	3900	4500	5200 $\mu$ mhos
Plate Resistance (Approx.).....	0.5	1.5	1.0 Megohm
Grid No. 1 Voltage for $I_b = 10 \mu a$ .....	-4.2	-5.5	-6.5 Volts

Color Television Type

**SYNC SEPARATOR (T)  
VIDEO AMPLIFIER (P)**

**6AU8A**  
8AU8A

**Medium Mu Triode and  
Sharp Cutoff Pentode**

Construction.....	Miniature T-6½
Base.....	Button 9 Pin, E9-1
Basing.....	.9DX
Outline.....	.6-3
Maximum Diameter.....	0.875 In.
Maximum Seated Height.....	2.375 In.
Maximum Overall Height.....	2.625 In.

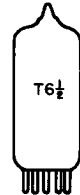
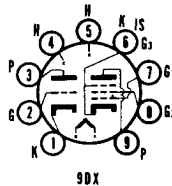

**ELECTRICAL DATA  
HEATER OPERATION**

	6AU8A	8AU8A
Heater Voltage.....	6.3	8.4 Volts
Heater Current.....	600	450 Ma
Heater Warm-up Time.....	11	11 Seconds
Maximum Heater-Cathode Voltage		
Heater Negative with Respect to Cathode		
Total DC and Peak.....	200	200 Volts
Heater Positive with Respect to Cathode		
DC.....	100	100 Volts
Total DC and Peak.....	200	200 Volts

**DIRECT INTERELECTRODE CAPACITANCES (Unshielded)**

**Triode Section**

Grid to Plate.....	2.2 Pf
Input.....	2.6 Pf
Output.....	0.34 Pf

**Pentode Section**

Grid to Plate.....	0.06 Pf
Input.....	7.5 Pf
Output.....	3.4 Pf

**Coupling**

Pentode Grid No. 1 to Triode Plate (Max.).....	0.006 Pf
Triode Grid to Pentode Plate (Max.).....	0.022 Pf
Pentode Plate to Triode Plate (Max.).....	0.12 Pf

**RATINGS (Design Center Rating System)**

	<b>Triode Section</b>	<b>Pentode Section</b>
Plate Voltage (Max.) .....	330	330 Volts
Grid No. 2 Supply Voltage (Max.) .....	—	330 Volts
Grid No. 2 Voltage (Max.) .....	See Rating Chart (Gen. Info. Sec.)	
Plate Dissipation (Max.) .....	2.8	3.3 Watts
Grid No. 2 Dissipation (Max.) .....	—	1.0 Watt
Positive Grid No. 1 Voltage (Max.) .....	0	0 Volt
Grid No. 1 Circuit Resistance		
Fixed Bias (Max.) .....	0.5	0.25 Megohm
Self Bias (Max.) .....	1.0	1.0 Megohm

**CHARACTERISTICS AND TYPICAL OPERATION**

	<b>Triode Section</b>	<b>Pentode Section</b>
<b>Class A1 Amplifier</b>		
Plate Voltage .....	150	200 Volts
Grid No. 2 Voltage .....	—	125 Volts
Cathode Bias Resistor .....	150	82 Ohms
Plate Current .....	9.5	17 Ma
Grid No. 2 Current .....	—	3.4 Ma
Transconductance .....	5300	8000 $\mu$ mhos
Amplification Factor .....	43	—
Plate Resistance (Approx.) .....	8100	100,000 Ohms
Grid No. 1 Voltage (Approx.)		
for $I_b = 100$ ma .....	-6.5	-7.5 Volts dc

**6AV5GA**12AV5GA, 17AV5GA,  
25AV5GA

Color Television Type

**HORIZONTAL DEFLECTION  
AMPLIFIER****Beam Power Pentode**

Construction ..... Octal T-11 or T-12  
 Base ..... Octal 6 Pin, B6-112 or B6-120  
 Basing ..... 6CK  
 Outline

    Maximum Diameter ..... 1.563 In.  
 Maximum Seated Height ..... 3.688 In.  
 Maximum Overall Height ..... 4.250 In.

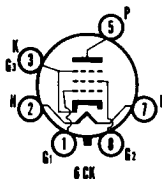
**ELECTRICAL DATA  
HEATER OPERATION**

	<b>25AV5GA</b>	<b>17AV5GA</b>	<b>12AV5GA</b>	<b>6AV5GA</b>
Heater Voltage .....	25	16.8	12.6	6.3 Volts
Heater Current .....	300	450	600	1200 Ma
Heater Warm-up Time .....	—	11	11	— Seconds
Maximum Heater-Cathode Voltage				
Heater Negative with Respect to Cathode				
Total DC and Peak .....				200 Volts
Heater Positive with Respect to Cathode				
DC .....				100 Volts
Total DC and Peak .....				200 Volts

**DIRECT INTERELECTRODE CAPACITANCES (Unshielded)**

Grid to Plate .....	0.5 Pf
Input .....	14 Pf
Output .....	7.0 Pf

**RATINGS (Design Center Rating System)****Horizontal Deflection Amplifier<sup>(1)</sup>**

DC Plate Supply Voltage (Boost + DC Power Supply) (Max.) .....	550 Volts
Peak Positive Plate Voltage (Abs. Max.) .....	5500 Volts
Peak Negative Plate Voltage (Max.) .....	1250 Volts
DC Grid No. 2 Voltage (Max.) .....	175 Volts
Peak Negative Grid No. 1 Voltage (Max.) .....	300 Volts
Plate Dissipation (Max.) <sup>(2)</sup> .....	11 Watts
Grid No. 2 Dissipation (Max.) .....	2.5 Watts
Average Cathode Current (Max.) .....	110 Ma
Peak Cathode Current (Max.) .....	400 Ma
Grid No. 1 Circuit Resistance (Max.) .....	0.47 Megohm
Bulb Temperature (At Hottest Point) (Max.) .....	210 °C

**CHARACTERISTICS AND TYPICAL OPERATION**

Plate Voltage .....	250 Volts
---------------------	-----------

Grid No. 2 Voltage .....	150 Volts
Grid No. 1 Voltage .....	-22.5 Volts
Plate Current .....	57 Ma
Grid No. 2 Current .....	2.1 Ma
Plate Resistance (Approx.) .....	14,500 Ohms
Transconductance .....	5900 $\mu$ mhos
Triode Amplification Factor <sup>(3)</sup> .....	4.3
Grid No. 1 Voltage (Approx.) for Ib = 1 Ma .....	-43 Volts

**INSTANTANEOUS PLATE KNEE VALUES**

Eb = 60 V, Ec2 = 150 V, and Ec1 = 0 V;  
Ib = 260 Ma; and Ic2 = 26 Ma

**NOTES:**

- (1) For operation in a 525 line, 30 frame system as described in "Standards of Good Engineering Practice for Television Broadcast Stations; Federal Communications Commission," the duty cycle of the voltage pulse must not exceed 15% of one horizontal scanning cycle.
- (2) In stages operating with grid-leak bias, an adequate cathode bias resistor or other suitable means is required to protect the tube in the absence of excitation.
- (3) Triode connection (screen tied to plate) with Eb = Ec2 = 150 Volts and Ec1 = -22.5 Volts.

*Color Television Type*

## DETECTOR and AF AMPLIFIER

# 6AV6

3AV6, 4AV6, 12AV6

**Double Diode and High Mu Triode**

Construction .....	Miniature T-5½
Base .....	Button 7 Pin, E7-1
Basing .....	7BT
Outline .....	5-2
Maximum Diameter .....	0.750 In.
Maximum Seated Height .....	1.875 In.
Maximum Overall Height .....	2.125 In.

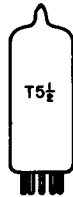
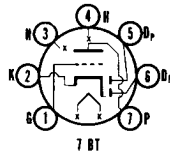

**ELECTRICAL DATA**

**HEATER OPERATION**

	3AV6	4AV6	12AV6	6AV6
Heater Voltage.....	3.15	4.2	12.6	6.3 Volts
Heater Current .....	600	450	150	300 Ma
Heater Warm-up Time .....	11	11	—	— Seconds
Maximum Heater-Cathode Voltage				
Heater Negative with Respect to Cathode				
Total DC and Peak.....				200 Volts
Heater Positive with Respect to Cathode				
DC .....				100 Volts
Total DC and Peak.....				200 Volts

**DIRECT INTERELECTRODE CAPACITANCES**

	Shielded <sup>(1)</sup>	Unshielded
Triode Grid to Plate.....	2.0	2.0 Pf
Triode Input .....	2.2	2.2 Pf
Triode Output.....	1.2	0.8 Pf
Grid to Diode No. 2 Plate <sup>(2)</sup> (Max.) .....	0.04	0.04 Pf

**RATINGS (Design Maximum Rating System)**

<b>Triode</b>	
Plate Voltage (Max.) .....	330 Volts
Plate Dissipation (Max.) .....	0.55 Watt
Positive Grid Voltage (Max.) .....	0 Volt

<b>Diode</b>	
Diode Plate Current Each Diode .....	1.0 Ma

**CHARACTERISTICS AND TYPICAL OPERATION**

**Triode**

**Class A1 Amplifier**

Plate Voltage .....	100	250 Volts
Grid Voltage .....	-1	-2 Volt
Plate Current .....	0.5	1.2 Ma
Plate Resistance.....	80,000	62,500 Ohms
Transconductance .....	1250	1600 $\mu$ mhos
Amplification Factor .....	100	100

**Diode (Each Section)**

Tube Voltage Drop for Ib = 1.2 Ma.....	10 Volts
--	----------

**NOTES:**

- (1) Shield No. 316 connected to cathode.
- (2) Diode plate No. 2 connects to Pin No. 5. Diode plate No. 1 connects to Pin No. 6.

# 6AV11

## Color Television Type AMPLIFIER, PHASE INVERTER or OSCILLATOR

**Triple Medium Mu Triode**

Construction.....Compactron T-9  
 Base .....Button 12 Pin, E12-70  
 Basing .....12BY  
 Outline .....9-56  
 Maximum Diameter .....1.188 In.  
 Maximum Seated Height .....1.500 In.  
 Maximum Overall Height .....1.875 In.

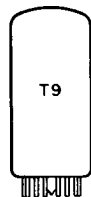
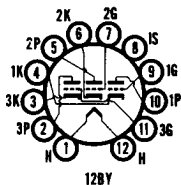

**ELECTRICAL DATA**

**HEATER OPERATION**

Heater Voltage.....6.3 Volts  
 Heater Current .....600 Ma  
 Maximum Heater-Cathode Voltage  
 Heater Negative with Respect to Cathode .....200 Volts  
 Total DC and Peak .....  
 Heater Positive with Respect to Cathode .....100 Volts  
 DC .....200 Volts  
 Total DC and Peak .....

**DIRECT INTERELECTRODE CAPACITANCES (Unshielded)**

	Section 1	Section 2	Section 3
Grid to Plate (g to p).....	1.2	1.2	1.2 Pf
Input: g to (h + k + IS) .....	1.9	1.9	1.9 Pf
Output: p to (h + k + IS) .....	1.8	0.7	2.0 Pf

**RATINGS (Design Maximum Rating System) (Each Section)**

Plate Voltage (Max.) .....330 Volts  
 Plate Dissipation (Max.) .....2.75 Watts  
 Total Plate Dissipation (All Plates) (Max.) .....6.0 Watts  
 DC Cathode Current (Max.) .....20 Ma  
 Grid Circuit Resistance  
 With Fixed Bias (Max.) .....0.25 Megohm  
 With Cathode Bias (Max.) .....1.0 Megohm

**CHARACTERISTICS AND TYPICAL OPERATION (Each Section)**

Plate Voltage .....	100	250 Volts
Grid Voltage .....	0	-8.5 Volts
Amplification Factor .....	20	17
Plate Resistance (Approx.) .....	6500	7700 Ohms
Transconductance .....	3100	2200 $\mu$ mhos
Plate Current .....	11.8	10.5 Ma
Grid Voltage (Approx.) .....	—	-24 Volts
$I_b = 10 \mu a$ .....	—	

# 6AW8A

8AW8A

## Color Television Type SYNC SEPARATOR (T) VIDEO AMPLIFIER (P)

**High Mu Triode and Sharp Cutoff Pentode**

Construction .....Miniature T-6½  
 Base .....Button 9 Pin, E9-1  
 Basing .....9DX  
 Outline .....6-3  
 Maximum Diameter .....0.875 In.  
 Maximum Seated Height .....2.375 In.  
 Maximum Overall Height .....2.625 In.

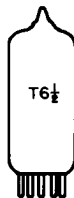
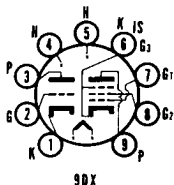

**ELECTRICAL DATA**

**HEATER OPERATION**

	8AW8A	6AW8A
Heater Voltage.....	8.4	6.3 Volts
Heater Current .....	450	600 Ma
Heater Warm-up Time .....	11	11 Seconds
Maximum Heater-Cathode Voltage Heater Negative with Respect to Cathode ..... Total DC and Peak .....		200 Volts

Heater Positive with Respect to Cathode

DC .....	100 Volts
Total DC and Peak.....	200 Volts

**DIRECT INTERELECTRODE CAPACITANCES**

	Shielded <sup>(1)</sup>	Unshielded
<b>Triode</b>		
Grid to Plate: (g to p) .....	2.2	2.2 Pf
Input: g to (h + k) .....	3.4	3.2 Pf
Output: p to (h+Tk+Pk+Pg3+IS).....	3.0	1.8 Pf
<b>Pentode</b>		
Grid to Plate: (g1 to p) (Max.) .....	0.05	0.06 Pf
Input: g1 to (g + k + g2 + g3 + IS) .....	10.0	10.0 Pf
Output: p to (h + k + g2 + g3 + IS).....	4.5	3.6 Pf
<b>Coupling</b>		
Pentode Grid No. 1 to Triode Plate (Max.) .....	0.005	0.008 Pf
Pentode Plate to Triode Grid .....	0.006	0.016 Pf
Pentode Plate to Triode Plate (Max.) .....	0.025	0.150 Pf

**RATINGS (Design Maximum Rating System)**

	Triode	Pentode
Plate Voltage (Max.) .....	330	330 Volts
Grid No. 2 Supply Voltage (Max.) .....	—	330 Volts
Grid No. 2 Voltage .....	See Rating Chart (Gen. Info. Sec.)	
Plate Dissipation (Max.) .....	1.1	3.75 Watts
Grid No. 2 Dissipation (Max.) .....	—	1.1 Watt
Negative Grid No. 1 Voltage (Max.) .....	—	50 Volts
Positive Grid No. 1 Voltage (Max.) .....	0	0 Volt
Grid No. 1 Circuit Resistance		
Fixed Bias (Max.) .....	0.5	0.25 Megohm
Self Bias (Max.) .....	1.0	1.0 Megohm

**CHARACTERISTICS AND TYPICAL OPERATION**

**Class A1 Amplifier**

	Triode	Pentode
Plate Voltage .....	200	150 Volts
Grid No. 2 Voltage .....	—	150 Volts
Grid No. 1 Voltage .....	-2	0 Volts
Cathode Bias Resistor .....	—	150 Ohms
Plate Current .....	4.0	15 Ma
Grid No. 2 Current .....	—	3.5 Ma
Transconductance .....	4000	9500 $\mu$ mhos
Amplification Factor .....	70	—
Plate Resistance (Approx.) .....	—	0.20 Megohm
Grid No. 1 Voltage (Approx.) .....	-5	-8 Volts

**INSTANTANEOUS PLATE KNEE VALUES**

Eb = 65 V, Ec2 = 150 V, and Ec1 = 0 V;  
Ib = 46 Ma; and Ic2 = 15 Ma

**NOTE:**

(1) Shield No. 315 ties to Pins 4 and 5.

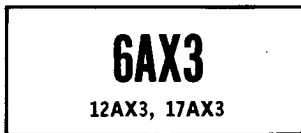

**Heater-Cathode Diode**

Construction..... Compactron T-9  
Base .....

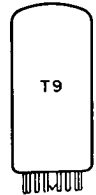
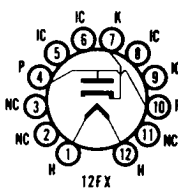

**ELECTRICAL DATA**  
**HEATER OPERATION**

	17AX3	12AX3	6AX3
Heater Voltage.....	16.8	12.6	6.3 Volts
Heater Current .....	450	600	1200 Ma
Heater Warm-up Time .....	11	11	— Seconds

# 6AV11

## Color Television Type AMPLIFIER, PHASE INVERTER or OSCILLATOR

### Triple Medium Mu Triode

Construction ..... Compactron T-9  
 Base ..... Button 12 Pin, E12-70  
 Basing ..... 12BY  
 Outline ..... 9-56  
 Maximum Diameter ..... 1.188 In.  
 Maximum Seated Height ..... 1.500 In.  
 Maximum Overall Height ..... 1.875 In.

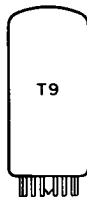
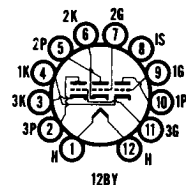

### ELECTRICAL DATA

#### HEATER OPERATION

Heater Voltage ..... 6.3 Volts  
 Heater Current ..... 600 Ma  
 Maximum Heater-Cathode Voltage  
 Heater Negative with Respect to Cathode  
 Total DC and Peak ..... 200 Volts  
 Heater Positive with Respect to Cathode  
 DC ..... 100 Volts  
 Total DC and Peak ..... 200 Volts

#### DIRECT INTERELECTRODE CAPACITANCES (Unshielded)

	Section 1	Section 2	Section 3
Grid to Plate (g to p).....	1.2	1.2	1.2 Pf
Input: g to (h + k + IS) .....	1.9	1.9	1.9 Pf
Output: p to (h + k + IS) .....	1.8	0.7	2.0 Pf

#### RATINGS (Design Maximum Rating System) (Each Section)

Plate Voltage (Max.) ..... 330 Volts  
 Plate Dissipation (Max.) ..... 2.75 Watts  
 Total Plate Dissipation (All Plates) (Max.) ..... 6.0 Watts  
 DC Cathode Current (Max.) ..... 20 Ma  
 Grid Circuit Resistance  
 With Fixed Bias (Max.) ..... 0.25 Megohm  
 With Cathode Bias (Max.) ..... 1.0 Megohm

#### CHARACTERISTICS AND TYPICAL OPERATION (Each Section)

Plate Voltage .....	100	250 Volts
Grid Voltage .....	0	-8.5 Volts
Amplification Factor .....	20	17
Plate Resistance (Approx.) .....	6500	7700 Ohms
Transconductance .....	3100	2200 $\mu$ mhos
Plate Current .....	11.8	10.5 Ma
Grid Voltage (Approx.) .....	—	-24 Volts
$I_b = 10 \mu$ a .....	—	—

# 6AW8A

8AW8A

### Color Television Type

## SYNC SEPARATOR (T) VIDEO AMPLIFIER (P)

### High Mu Triode and Sharp Cutoff Pentode

Construction ..... Miniature T-6½  
 Base ..... Button 9 Pin, E9-1  
 Basing ..... 9DX  
 Outline ..... 6-3  
 Maximum Diameter ..... 0.875 In.  
 Maximum Seated Height ..... 2.375 In.  
 Maximum Overall Height ..... 2.625 In.

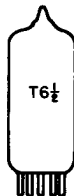
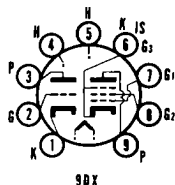

### ELECTRICAL DATA

#### HEATER OPERATION

	6AW8A	8AW8A
Heater Voltage.....	8.4	6.3 Volts
Heater Current .....	450	600 Ma
Heater Warm-up Time .....	11	11 Seconds
Maximum Heater-Cathode Voltage Heater Negative with Respect to Cathode Total DC and Peak.....		200 Volts

Heater Positive with Respect to Cathode

DC .....	100 Volts
Total DC and Peak .....	200 Volts

**DIRECT INTERELECTRODE CAPACITANCES**

	Shielded <sup>(1)</sup>	Unshielded
<b>Triode</b>		
Grid to Plate: (g to p) .....	2.2	2.2 Pf
Input: g to (h + k) .....	3.4	3.2 Pf
Output: p to (h+Tk+Pk+Pg3+IS) .....	3.0	1.8 Pf
<b>Pentode</b>		
Grid to Plate: (g1 to p) (Max.) .....	0.05	0.06 Pf
Input: g1 to (g + k + g2 + g3 + IS) .....	10.0	10.0 Pf
Output: p to (h + k + g2 + g3 + IS) .....	4.5	3.6 Pf
<b>Coupling</b>		
Pentode Grid No. 1 to Triode Plate (Max.) .....	0.005	0.008 Pf
Pentode Plate to Triode Grid .....	0.006	0.016 Pf
Pentode Plate to Triode Plate (Max.) .....	0.025	0.150 Pf

**RATINGS (Design Maximum Rating System)**

	Triode	Pentode
Plate Voltage (Max.) .....	330	330 Volts
Grid No. 2 Supply Voltage (Max.) .....	—	330 Volts
Grid No. 2 Voltage .....	See Rating Chart (Gen. Info. Sec.)	
Plate Dissipation (Max.) .....	1.1	3.75 Watts
Grid No. 2 Dissipation (Max.) .....	—	1.1 Watt
Negative Grid No. 1 Voltage (Max.) .....	—	50 Volts
Positive Grid No. 1 Voltage (Max.) .....	0	0 Volt
Grid No. 1 Circuit Resistance		
Fixed Bias (Max.) .....	0.5	0.25 Megohm
Self Bias (Max.) .....	1.0	1.0 Megohm

**CHARACTERISTICS AND TYPICAL OPERATION**

**Class A1 Amplifier**

	Triode	Pentode
Plate Voltage .....	200	150 Volts
Grid No. 2 Voltage .....	—	150 Volts
Grid No. 1 Voltage .....	-2	0 Volts
Cathode Bias Resistor .....	—	150 Ohms
Plate Current .....	4.0	15 Ma
Grid No. 2 Current .....	—	3.5 Ma
Transconductance .....	4000	9500 $\mu$ mhos
Amplification Factor .....	70	—
Plate Resistance (Approx.) .....	—	0.20 Megohm
Grid No. 1 Voltage (Approx.) .....		
for Ib = 20 $\mu$ a .....	-5	-8 Volts

**INSTANTANEOUS PLATE KNEE VALUES**

Eb = 65 V, Ec2 = 150 V, and Ec1 = 0 V;  
Ib = 46 Ma; and Ic2 = 15 Ma

**NOTE:**

(1) Shield No. 315 ties to Pins 4 and 5.

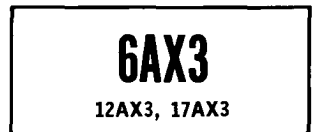

**Heater-Cathode Diode**

Construction.....Compactron T-9  
Base .....

    Button 12 Pin, E12-70  
Basing .....

**ELECTRICAL DATA**

**HEATER OPERATION**

Heater Voltage.....	16.8
Heater Current .....	450
Heater Warm-up Time .....	11

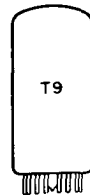
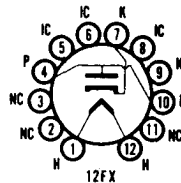

	17AX3	12AX3	6AX3
Heater Voltage.....	16.8	12.6	6.3 Volts
Heater Current .....	450	600	1200 Ma
Heater Warm-up Time .....	11	11	— Seconds

Maximum Heater-Cathode Voltage	
Heater Negative with Respect to Cathode	
DC .....	900 Volts
Total DC and Peak .....	5000 Volts
Heater Positive with Respect to Cathode	
DC .....	100 Volts
Total DC and Peak .....	300 Volts

**DIRECT INTERELECTRODES CAPACITANCES (Unshielded)**

Cathode to Plate and Heater .....	7.5 Pf
Plate to Cathode and Heater .....	5.5 Pf
Heater to Cathode .....	2.8 Pf

**RATINGS (Design Maximum Rating System)****Damper Service<sup>(1)</sup>**

Peak Inverse Plate Voltage (Max.) .....	5000 Volts
Plate Dissipation (Max.) .....	5.3 Watts
Steady State Peak Plate Current (Max.) .....	1000 Ma
DC Output Current (Max.) .....	165 Ma

**CHARACTERISTICS AND TYPICAL OPERATION**

Tube Voltage Drop for $I_b = 250$ Ma .....	32 Volts
--	----------

**NOTE:**

- (1) For operation in a 525 line, 30 frame system as described in "Standards of Good Engineering Practice for Television Broadcast Stations; Federal Communications Commission," the duty cycle of the voltage pulse must not exceed 15% of one horizontal scanning cycle.

**6AX4GTB**12AX4GTB,  
17AX4GTA/17DM4A

Color Television Type

**DAMPER****Heater-Cathode Diode**

Construction .....	Octal T-9
Base .....	Octal 5 Pin, B5-82
Basing <sup>(1)</sup> .....	4CG
Outline .....	9-11
Maximum Diameter .....	1.188 In.
Maximum Seated Height .....	2.750 In.
Maximum Overall Height .....	3.313 In.

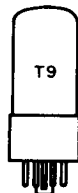
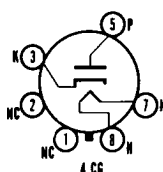
**ELECTRICAL DATA****HEATER OPERATION**

	17AX4GTA/ 17DM4A	12AX4GTB	6AX4GTB
Heater Voltage .....	16.8	12.6	6.3 Volts
Heater Current .....	450	600	1200 Ma
Heater Warm-up Time .....	11	11	— Seconds
Maximum Heater-Cathode Voltage			
Heater Negative with Respect to Cathode			
DC .....			900 Volts
Total DC and Peak .....			5000 Volts
Heater Positive with Respect to Cathode			
DC .....			100 Volts
Total DC and Peak .....			300 Volts

**DIRECT INTERELECTRODE CAPACITANCES (Unshielded)**

Cathode to Plate and Heater .....	8.5 Pf
Plate to Cathode and Heater .....	5.0 Pf
Heater to Cathode .....	4.0 Pf

**RATINGS (Design Maximum Rating System)****Damper Service<sup>(2)</sup>**

Peak Inverse Voltage (Max.) .....	5000 Volts
Plate Dissipation (Max.) .....	5.3 Watts
DC Plate Current (Max.) .....	165 Ma
Steady State Peak Current (Max.) .....	1000 Ma

**CHARACTERISTICS AND TYPICAL OPERATION**

Tube Voltage Drop for $I_b = 250$ Ma .....	32 Volts
--	----------

**NOTES:**

- (1) Pins 1, 2, 4, and 6 shall not be used as tie points.  
 (2) For operation in a 525 line, 30 frame system as described in "Standards of Good Engineering Practice for Television Broadcast Stations; Federal Communications Commission," the duty cycle of the voltage pulse must not exceed 15% of one horizontal scanning cycle.



**FULL-WAVE POWER RECTIFIER**

**6AX5GT**

**Heater-Cathode Twin Diode**

Construction .....Octal T-9  
 Base .....Octal 6 Pin  
 Basing.....6S  
 Outline  
 Maximum Diameter .....1.188 In.  
 Maximum Seated Height .....2.750 In.  
 Maximum Overall Height .....3.313 In.

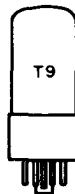
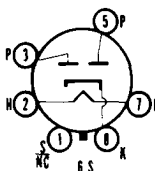

**ELECTRICAL DATA**

**HEATER OPERATION**

Heater Voltage.....6.3 Volts  
 Heater Current .....1200 Ma  
 Maximum Heater-Cathode Voltage .....450 Volts

**RATINGS (Design Maximum Rating System)**

**Rectifier Service<sup>(1)</sup>**

Peak Inverse Plate Voltage (Max.) .....1250 Volts  
 Peak Plate Current (Each Plate) (Max.) .....375 Ma  
 AC Plate Voltage (Each Plate, RMS) (Max.) .....450 Volts  
 Steady State DC Output Current (Max.).....75 Ma

**CHARACTERISTICS AND TYPICAL OPERATION**

**Full-Wave Rectifier—Choke Input to Filter**

AC Plate to Plate Supply Voltage (RMS) .....700 900 Volts  
 Filter Input Choke .....10 10 Henrys  
 DC Output Voltage at Input to Filter  
 At Half Load Current of 150 Ma .....270 — Volts  
 At Half Load Current of 125 Ma .....— 365 Volts  
 At Full Load Current of 75 Ma .....250 — Volts  
 At Full Load Current of 62.5 Ma .....— 350 Volts  
 Voltage Regulation (Half Load to Full Load) .....20 15 Volts

**Full-Wave Rectifier—Capacitor Input to Filter**

AC Plate to Plate Supply Voltage (RMS) .....700 900 Volts  
 Filter Input Capacitor .....10 10  $\mu$ f  
 Effective Plate Supply Impedance (Each Plate) .....50 105 Ohms  
 DC Output Voltage at Input to Filter  
 At Half Load Current of 62.5 Ma .....395 — Volts  
 At Half Load Current of 40 Ma .....— 540 Volts  
 At Full Load Current of 125 Ma .....350 — Volts  
 At Full Load Current of 80 Ma .....— 490 Volts  
 Voltage Regulation (Half Load to Full Load) .....45 50 Volts

**NOTE:**

(1) For use with sinusoidal supply voltages within the frequency range of 25 to 1000 hertz.

**DAMPER**

**6AY3**

12AY3, 17AY3

**Heater-Cathode Diode**

Construction .....Novar T-9  
 Base .....Novar Button 9 Pin, E9-75  
 Basing<sup>(1)</sup> .....9HP  
 Outline .....9-86  
 Maximum Diameter .....1.188 In.  
 Maximum Seated Height .....3.030 In.  
 Maximum Overall Height .....3.410 In.

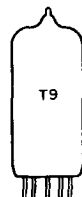
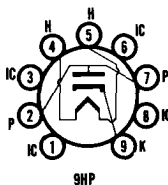

**ELECTRICAL DATA**

**HEATER OPERATION**

Heater Voltage.....	16.8	12.6	6.3 Volts
Heater Current.....	450	600	1200 Ma
Heater Warm-up Time.....	11	11	— Seconds

Maximum Heater-Cathode Voltage

Heater Negative with Respect to Cathode

DC .....	900 Volts
Total DC and Peak.....	5000 Volts

Heater Positive with Respect to Cathode

DC .....	100 Volts
Total DC and Peak.....	300 Volts

**DIRECT INTERELECTRODE CAPACITANCES (Unshielded)**

Heater to Cathode .....	2.8 Pf
Plate to Cathode and Heater.....	6.5 Pf
Cathode to Plate and Heater.....	9.0 Pf

**RATINGS (Design Maximum Rating System)**

**Damper Service<sup>(2)</sup>**

Peak Inverse Plate Voltage (Max.) .....	5000 Volts
Plate Dissipation (Max.) .....	6.3 Watts
Steady State Peak Current (Max.) .....	1100 Ma
DC Plate Current (Max.) .....	175 Ma

**NOTES:**

- (1) Pins 1, 3, 6, and 8 should not be used as tie points.
- (2) For operation in a 525 line, 30 frame system as described in "Standards of Good Engineering Practice for Television Broadcast Stations; Federal Communications Commission," the duty cycle of the voltage pulse must not exceed 15% of one horizontal scanning cycle.



**Heater-Cathode Diode**

Construction .....Novar T-9  
 Base .....Novar Button 9 Pin, E9-75  
 Basing .....9HP  
 Outline .....9-85  
 Maximum Diameter .....1.188 In.  
 Maximum Seated Height .....2.730 In.  
 Maximum Overall Height .....3.110 In.

6AY3A is identical to 6AY3 except for shorter bulb.

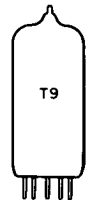
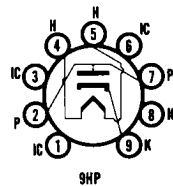

**Heater-Cathode Diode**

Construction .....Novar T-9  
 Base .....Novar Button 9 Pin, E9-89  
 (Exhaust Tip on Base)  
 Basing .....9HP  
 Outline .....  
 Maximum Diameter .....1.188 In.  
 Maximum Seated Height .....2.625 In.  
 Maximum Overall Height .....3.005 In.

6AY3B, 12AY3A, 17AY3A are identical to 6AY3, 6AY3A, 12AY3, 17AY3 except for base with exhaust tip at bottom and shorter bulb.

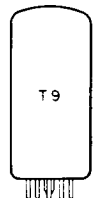
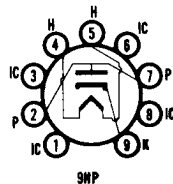

Color Television Type

## FM DETECTOR AF AMPLIFIER

# 6AY11

**Double Diode and  
Double High Mu Triode**

Construction ..... Compactron T-9  
 Base ..... Button 12 Pin, E12-70  
 Basing ..... 12DA  
 Outline ..... 9-56  
 Maximum Diameter ..... 1.188 In.  
 Maximum Seated Height ..... 1.500 In.  
 Maximum Overall Height ..... 1.875 In.

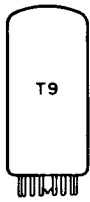
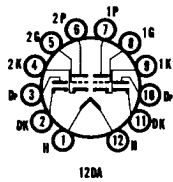

**ELECTRICAL DATA**

**HEATER OPERATION**

Heater Voltage .....	6.3 Volts
Heater Current .....	690 Ma
Maximum Heater-Cathode Voltage	
Heater Negative with Respect to Cathode	
Total DC and Peak .....	200 Volts
Heater Positive with Respect to Cathode	
DC .....	100 Volts
Total DC and Peak .....	200 Volts

**DIRECT INTERELECTRODE CAPACITANCES (Unshielded)**

**Triode (Each Section)**

Grid to Plate .....	2.2 Pf
Input .....	2.0 Pf
Output .....	0.22 Pf

**Diode (Each Section)**

Plate to Cathode and Heater .....	2.0 Pf
Cathode to Heater and Plate .....	5.5 Pf

**Coupling**

Triode Grid to Diode Plate (Max.) .....	0.08 Pf
Triode Grid (Sec. 1) to Triode Grid (Sec. 2) (Max.) .....	0.01 Pf
Triode Plate (Sec. 1) to Triode Plate (Sec. 2) .....	0.48 Pf

**RATINGS (Design Maximum Rating System)**

**Triode (Each Section)**

Plate Voltage (Max.) .....	330 Volts
Positive DC Grid Voltage (Max.) .....	0 Volt
Negative DC Grid Voltage (Max.) .....	50 Volts
Plate Dissipation (Max.) .....	1.0 Watts

**Diode (Each Section)**

Diode Current for Continuous Operation .....	5.0 Ma
--	--------

**CHARACTERISTICS AND TYPICAL OPERATION**

**Triode (Each Section)**

Plate Voltage .....	250 Volts
Grid Voltage .....	-2.0 Volts
Amplification Factor .....	100
Plate Resistance (Approx.) .....	52,700 Ohms
Transconductance .....	1900 $\mu$ hms
Plate Current .....	1.2 Ma

**Diode (Each Section)**

Average Diode Current with 5.0 Voltage DC Applied .....	18 Ma
---	-------

Color Television Type

## SYNC SEPARATOR/CLIPPER(T) IF/VIDEO/AGC AMPLIFIER(P)

# 6AZ8

**Medium Mu Triode and Sharp Cutoff Pentode**

Construction ..... Miniature T-6-1/2  
 Base ..... Button 9 Pin, E9-1  
 Basing ..... 9ED  
 Outline ..... 6-2  
 Maximum Diameter ..... 0.875 In.  
 Maximum Seated Height ..... 1.938 In.  
 Maximum Overall Height ..... 2.188 In.

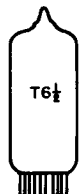
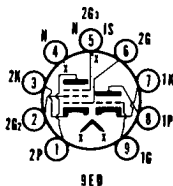

**ELECTRICAL DATA**

**HEATER OPERATION**

Heater Voltage.....	6.3 Volts
Heater Current .....	450 Ma
Maximum Heater-Cathode Voltage	
Heater Negative with Respect to Cathode	
Total DC and Peak.....	200 Volts
Heater Positive with Respect to Cathode	
DC .....	100 Volts
Total DC and Peak.....	200 Volts

**DIRECT INTERELECTRODE CAPACITANCES**

**Triode**

Grid to Plate .....	1.7 Pf
Grid to Cathode, Heater, Pentode Grid No. 3 and Internal Shield .....	2.0 Pf
Plate to Cathode, Heater, Pentode Grid No. 3 and Internal Shield .....	1.7 Pf

**Pentode**

Grid No. 1 to Plate (Max.).....	0.02 Pf
Grid No. 1 to Cathode, Heater, Grid No. 2, Grid No. 3 and Internal Shield .....	6.5 Pf
Plate to Cathode, Heater, Grid No. 2, Grid No. 3 and Internal Shield .....	2.2 Pf

**Coupling**

Triode Grid to Pentode Plate (Max.) .....	0.027 Pf
Pentode Grid No. 1 to Triode Plate (Max.) .....	0.020 Pf
Pentode Plate to Triode Plate (Max.) .....	0.045 Pf

**RATINGS (Design Center Rating System)**

	<b>Triode</b>	<b>Pentode</b>
Plate Voltage (Max.) .....	300	300 Volts
Grid No. 2 Supply Voltage (Max.) .....	—	300 Volts
Grid No. 2 Voltage.....	See Rating Chart (Gen. Info. Sec.)	
Grid No. 1 Voltage (Positive Bias) (Max.) .....	0	0 Volt
Plate Dissipation (Max.) .....	2.6	2 Watts
Grid No. 2 Input		
For Grid No. 2 Voltage up to 150 Volts (Max.).....	—	0.5 Watt
For Grid No. 2 Voltage Between 150 and 300 Volts .....	See Rating Chart (Gen. Info. Sec.)	
Maximum Circuit Values		
Grid No. 1 Circuit Resistance		
Fixed Bias .....	0.5	0.25 Megohm
Cathode Bias .....	1.0	1.0 Megohm

**CHARACTERISTICS AND TYPICAL OPERATION**

	<b>Triode</b>	<b>Pentode</b>
Plate Supply Voltage.....	200	200 Volts
Grid No. 2 Voltage .....	—	150 Volts
Grid No. 1 Voltage .....	- 6	— Volts
Cathode Bias Resistor .....	—	180 Ohms
Plate Resistance .....	5750	300,000 Ohms
Transconductance .....	3300	6000 $\mu$ mhos
Grid No. 1 Voltage for $I_b = 10 \mu$ a .....	-19	— Volts
Grid No. 1 Voltage for $G_m = 10 \mu$ mhos .....	—	-12.5 Volts
Plate Current .....	13	9.5 Ma
Grid No. 2 Current .....	—	3 Ma

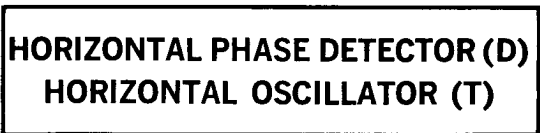

**Double Diode and Medium Mu Twin Triode**

Construction..... Compactron T-9  
 Base ..... Button 12 Pin, E12-70  
 Basing ..... 12BF  
 Outline

Maximum Diameter .....1.188 In.  
 Maximum Seated Height .....1.500 In.  
 Maximum Overall Height .....1.846 In.

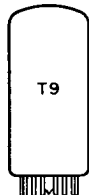
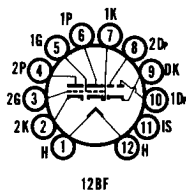

**ELECTRICAL DATA**  
**HEATER OPERATION**

	<b>8B10</b>	<b>6B10</b>
Heater Voltage.....	8.5	6.3 Volts
Heater Current .....	450	600 Ma
Heater Warm-up Time .....	11	11 Seconds

Maximum Heater-Cathode Voltage	
Heater Negative with Respect to Cathode	
Total DC and Peak .....	200 Volts
Heater Positive with Respect to Cathode	
DC .....	100 Volts
Total DC and Peak .....	200 Volts

**DIRECT INTERELECTRODE CAPACITANCES (Unshielded)**

<b>Triode No. 1</b>	
Grid to Plate .....	1.5 Pf
Input: 1Tg to (h + 1Tk + IS) .....	1.7 Pf
Output: 1Tp to (h + 1Tk + IS) .....	1.6 Pf

<b>Triode No. 2</b>	
Grid to Plate .....	1.5 Pf
Input: 2Tg to (h + 2Tk + IS) .....	1.8 Pf
Output: 2Tp to (h + 2Tk + IS) .....	0.6 Pf

<b>Diode No. 1</b>	
Plate to Cathode, Heater and Internal Shield .....	1.9 Pf

<b>Diode No. 2</b>	
Plate to Cathode, Heater, and Internal Shield .....	1.8 Pf

<b>Coupling</b>	
Triode Plate to Triode Plate .....	0.9 Pf
Diode Plate to Diode Plate .....	0.7 Pf
Triode No. 1 Grid to Diode No. 1 Plate .....	1.015 Pf
Triode No. 2 Grid to Diode No. 1 Plate .....	0.005 Pf
Triode No. 1 Grid to Diode No. 2 Plate .....	0.02 Pf
Triode No. 2 Grid to Diode No. 2 Plate .....	0.005 Pf

**RATINGS (Design Maximum Rating System)**

<b>Triode (Each Section)</b>	
Plate Voltage .....	330 Volts
Plate Dissipation .....	2.5 Watts
DC Cathode Current .....	20 Ma
Grid Circuit Resistance	
Fixed Bias .....	0.25 Megohm
Cathode Bias .....	1.0 Megohm

<b>Diode (Each Section)</b>	
Average Diode Current for Eb = 5 Volts .....	20 Ma

**CHARACTERISTICS AND TYPICAL OPERATION**

<b>Triode (Each Section)</b>	
Plate Voltage .....	250 Volts
Grid Voltage .....	-9.5 Volts
Plate Current .....	7.0 Ma
Amplification Factor .....	18
Plate Resistance .....	9750 Ohms
Transconductance .....	1850 $\mu$ mhos
Grid Voltage for Ib = 50 $\mu$ a .....	-20 Volts

<b>Diode (Each Section)</b>	
Average Diode Current for Eb = 5 Volts .....	20 Ma

Color Television Type  
**RF/IF AMPLIFIER**

**6BA6/EF93**  
3BA6, 4BA6, 12BA6

**Semi-Remote Cutoff Pentode**

Construction .....	Miniature T-5 $\frac{1}{2}$
Base .....	Button 7 Pin, E7-1
Basing .....	.7BK
Outline .....	5-2
Maximum Diameter .....	0.750 In.
Maximum Seated Height .....	1.875 In.
Maximum Overall Height .....	2.125 In.

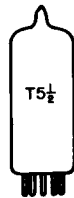
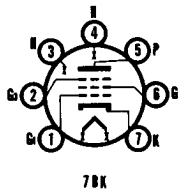

**ELECTRICAL DATA**

**HEATER OPERATION**

	3BA6	4BA6	12BA6	6BA6/EF93
Heater Voltage .....	3.15	4.2	12.6	6.3 Volts
Heater Current .....	600	450	150	300 Ma
Heater Warm-up Time .....	11	11	—	— Seconds
Maximum Heater-Cathode Voltage				
Heater Negative with Respect to Cathode				
Total DC and Peak .....				200 Volts
Heater Positive with Respect to Cathode				
DC .....				100 Volts
Total DC and Peak .....				200 Volts

**DIRECT INTERELECTRODE CAPACITANCES**

	Shielded <sup>(1)</sup>	Unshielded
Grid No. 1 to Plate (Max.).....	0.0035	0.0035 Pf
Input .....	5.5	5.5 Pf
Output .....	5.5	5.0 Pf

**RATINGS (Design Maximum Rating System)**

Plate Voltage (Max.) .....	330 Volts
Grid No. 2 Supply Voltage (Max.) .....	330 Volts
Grid No. 2 Voltage .....	See Rating Chart (Gen. Info. Sec.)
Plate Dissipation (Max.) .....	3.4 Watts
Grid No. 2 Dissipation (Max.) .....	0.7 Watt
Negative Grid No. 1 Voltage (Max.) .....	55 Volts
Positive Grid No. 1 Voltage (Max.) .....	0 Volt

**CHARACTERISTICS AND TYPICAL OPERATION**

Plate Voltage .....	100	250 Volts
Grid No. 3 Voltage .....	Connected to Cathode at Socket	
Grid No. 2 Voltage .....	100	100 Volts
Cathode Bias Resistor .....	68	68 Ohms
Plate Resistance (Approx.) .....	0.25	1.0 Megohm
Transconductance .....	4300	4200 $\mu$ mhos
Plate Current .....	10.8	11.0 Ma
Grid No. 2 Current .....	4.4	4.2 Ma
Grid No. 1 Voltage for $G_m = 40 \mu$ mhos .....	-20	-20 Volts

**NOTE:**

(1) External Shield No. 316 Connected to Pin 7 (cathode).



**Medium Mu Triode and Sharp Cutoff Pentode**

Construction ..... Miniature T-6½  
 Base ..... Button 9 Pin, E9-1  
 Basing ..... 9DX  
 Outline ..... 6-3  
 Maximum Diameter ..... 0.875 In.  
 Maximum Seated Height ..... 2.375 In.  
 Maximum Overall Height ..... 2.625 In.

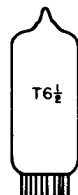
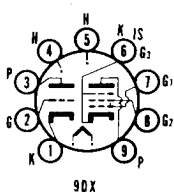

**ELECTRICAL DATA**

**HEATER OPERATION**

	8BA8A	6BA8A
Heater Voltage.....	8.4	6.3 Volts
Heater Current .....	450	600 Ma
Heater Warm-up Time .....	11	11 Seconds
Maximum Heater-Cathode Voltage		
Heater Negative with Respect to Cathode		
Total DC and Peak.....		200 Volts
Heater Positive with Respect to Cathode		
DC .....		100 Volts
Total DC and Peak.....		200 Volts

**DIRECT INTERELECTRODE CAPACITANCES**

**Triode**

	Shielded <sup>(1)</sup>	Unshielded
Grid to Plate: (g to p) .....	2.2	2.2 Pf
Input: g to (h + k) .....	2.7	2.5 Pf
Output: p to (h + k) .....	1.9	0.4 Pf

**Pentode**

Grid to Plate: (g1 to p) (Max.) .....	0.05	0.06 Pf
Input: g1 to (h + k + g2 + g3 + IS).....	10.0	10.0 Pf
Output: p to (h + k + g2 + g3 + IS).....	4.5	3.6 Pf

**Coupling**

Pentode Grid No. 1 to Triode Plate (Max.) .....	0.003	0.006 Pf
Pentode Plate to Triode Grid (Max.) .....	0.006	0.016 Pf
Pentode Plate to Triode Plate (Max.) .....	0.023	0.150 Pf

**RATINGS (Design Center Rating System)**

	Triode	Pentode
Plate Voltage (Max.) .....	300	300 Volts
Grid No. 2 Supply Voltage (Max.) .....	—	300 Volts
Grid No. 2 Voltage .....	See Rating Chart (Gen. Info. Sec.)	
Plate Dissipation (Max.) .....	2.0	3.25 Watts
Grid No. 2 Dissipation (Max.) .....	—	1.0 Watt
Negative Grid No. 1 Voltage (Max.) .....	—	50 Volts

Positive Grid No. 1 Voltage (Max.) .....	—	0 Volt
Grid No. 1 Circuit Resistance .....		
Fixed Bias (Max.) .....	0.5	0.25 Megohm
Self Bias (Max.) .....	1.0	1.0 Megohm

**CHARACTERISTICS AND TYPICAL OPERATION**

**Class A1 Amplifier**

	<b>Triode</b>	<b>Pentode</b>
Plate Voltage .....	200	200 Volts
Grid No. 2 Voltage .....	—	150 Volts
Grid No. 1 Voltage .....	-8	0 Volts
Cathode Bias Resistor .....	—	180 Ohms
Plate Current .....	8.0	13 Ma
Grid No. 2 Current .....	—	3.5 Ma
Transconductance .....	2700	9000 $\mu$ mhos
Amplification Factor .....	18	—
Plate Resistance (Approx.) .....	6700	400,000 Ohms
Grid No. 1 Voltage for $I_b = 10 \mu a$ (Approx.) .....	-16	-10 Volts

**INSTANTANEOUS PLATE KNEE VALUES**

$E_b = 65 V$ ,  $E_{c2} = 150 V$ , and  $E_{c1} = 0 V$ ;  
 $I_b = 42 Ma$ ; and  $I_{c2} = 12.5 Ma$

**NOTE:**

(1) Shield No. 315 ties to cathode base pin of section under test.

Color Television Type

**VERTICAL DEFLECTION OSC. (T)  
 SYNC/AGC AMPLIFIER (P)**

**6BA11**

8BA11

**Medium Mu Triode and Twin Pentode**

Construction.....Compactron T-9  
 Base .....Button 12 Pin, E12-70  
 Basing .....12ER  
 Outline .....9-58  
     Maximum Diameter .....1.188 In.  
     Maximum Seated Height .....2.000 In.  
     Maximum Overall Height .....2.375 In.

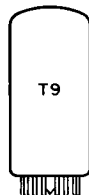
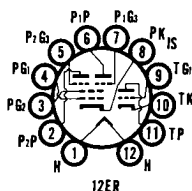

**ELECTRICAL DATA**

**HEATER OPERATION**

	<b>8BA11</b>	<b>6BA11</b>
Heater Voltage.....	8.4	6.3 Volts
Heater Current .....	450	600 Ma
Heater Warm-up Time .....	11	11 Seconds
Maximum Heater-Cathode Voltage .....		
Heater Negative with Respect to Cathode .....		
Total DC and Peak.....		200 Volts
Heater Positive with Respect to Cathode .....		
DC .....		100 Volts
Total DC and Peak.....		200 Volts

**DIRECT INTERELECTRODE CAPACITANCES (Unshielded)**

**Pentode Section**

Grid No. 3 to Plate (Each Pentode) .....	2.0 Pf
Grid No. 1 to All.....	5.0 Pf
Grid No. 3 (Each Pentode to All) .....	3.6 Pf
Plate (Each Pentode to All) .....	3.0 Pf
Grid No. 3 (Pentode 1) to Grid No. 3 (Pentode 2) (Max.).....	0.026 Pf

**Triode Section**

Grid to Plate .....	2.0 Pf
Input: $g_1$ to $(k + h)$ .....	2.0 Pf
Output: $p$ to $(k + h + IS)$ .....	1.9 Pf

**RATINGS (Design Maximum Rating System)**

	<b>Triode Section</b>	<b>Pentode Section</b>
Plate Voltage .....	300	300 Volts
Grid No. 2 Voltage .....	—	150 Volts
Positive DC Grid No. 3 Voltage .....	—	3.0 Volts
Negative DC Grid No. 3 Voltage .....	—	50 Volts
Peak Positive Grid No. 3 Voltage.....	—	50 Volts

Negative DC Grid No. 1 Voltage .....	—	50 Volts
Plate Dissipation (Each Plate) .....	1.5	1.1 Watts
Grid No. 2 Dissipation .....	—	0.75 Watt
DC Cathode Current .....	20	12 Ma
Grid No. 3 Circuit Resistance (Each Grid).....	—	0.5 Megohm
Grid No. 1 Circuit Resistance .....		
Fixed Bias .....	0.25	0.5 Megohm
Cathode Bias .....	1.0	0.5 Megohm

**CHARACTERISTICS AND TYPICAL OPERATION**

	Pentode				
	Triode Section	Each Section Separately <sup>(2)</sup>		Both Sections Operating <sup>(3)</sup>	
Plate Voltage .....	250	100	100	100	100 Volts
Grid No. 2 Voltage .....	—	67.5	67.5	67.5	67.5 Volts
Grid No. 3 Voltage .....	—	0	0	-10	0 Volts
Grid No. 1 Voltage .....	-11	0	Note 1	Note 1	Note 1 Volts
Plate Current .....	5.0	—	2.5	0	2.5 Ma
Grid No. 2 Current .....	—	—	—	7.0	4.4 Ma
Grid No. 1 Transconductance ...	1800	1700	—	—	— $\mu$ mhos
Amplification Factor .....	18	—	—	—	—
Grid No. 3 Transconductance ...	—	—	450	—	— $\mu$ mhos
Grid No. 1 Voltage I <sub>b</sub> = 100 $\mu$ a .....	-18	2.3	—	—	— Volts
Grid No. 3 Voltage (Approx.) For I <sub>b</sub> = 100 $\mu$ a .....	—	—	-3.2	—	— Volts

**NOTES:**

- (1) Grid current adjusted for 100  $\mu$ a DC.
- (2) Plate and Grid No. 3 of opposite section grounded.
- (3) Voltages and plate current apply to each section.

**AVERAGE PLATE CHARACTERISTICS  
(Pentode Section)  
(with Opposite Grid No. 3 and Plate Grounded)**

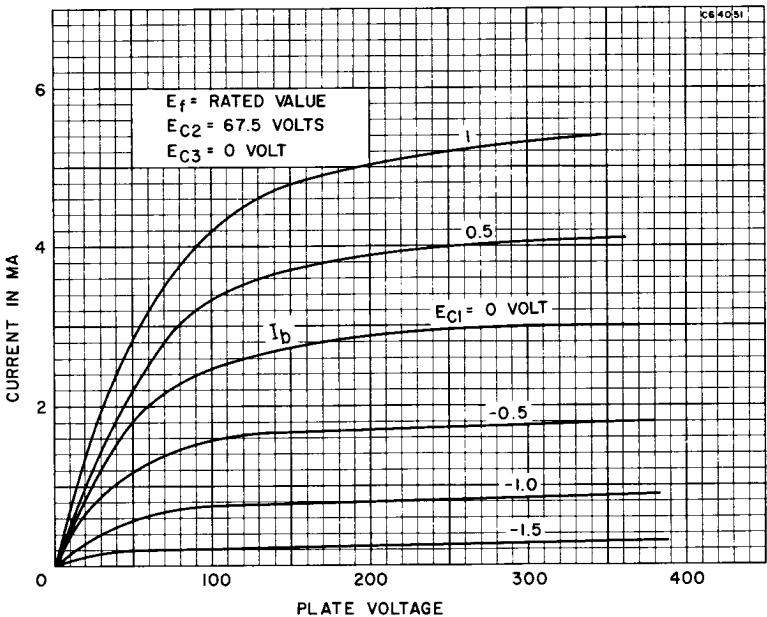



**AVERAGE PLATE CHARACTERISTICS  
(Triode Section)**

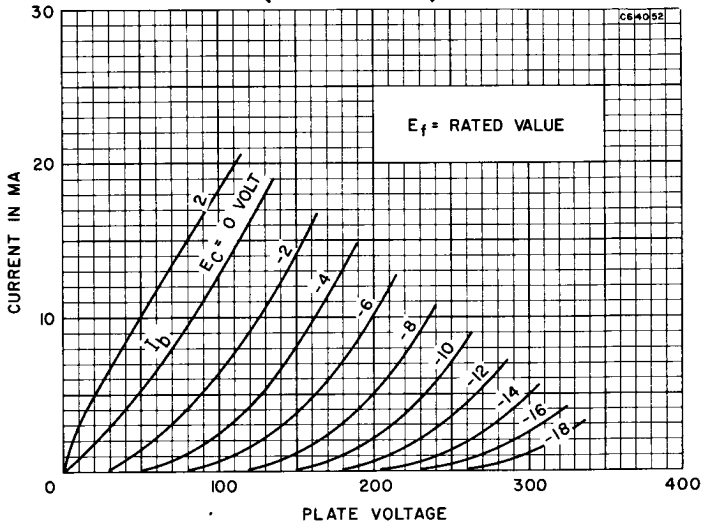

**RF AMPLIFIER**

**6BC4**

**Medium Mu Triode**

Construction ..... Miniature T-6½  
 Base ..... Button 9 Pin, E9-1  
 Basing ..... 9DR  
 Outline ..... 6-1  
 Maximum Diameter ..... 0.875 In.  
 Maximum Seated Height ..... 1.500 In.  
 Maximum Overall Height ..... 1.750 In.

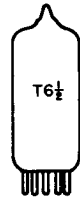
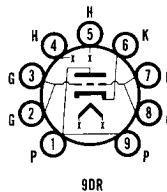

**ELECTRICAL DATA**

**HEATER OPERATION**

Heater Voltage ..... 6.3 Volts  
 Heater Current ..... 225 Ma  
 Maximum Heater-Cathode Voltage ..... 75 Volts

**DIRECT INTERELECTRODE CAPACITANCES (Unshielded)**

Grid to Plate ..... 1.6 Pf  
 Grid to Cathode and Heater ..... 2.9 Pf  
 Plate to Cathode and Heater ..... 0.26 Pf  
 Heater to Cathode ..... 2.7 Pf

**RATINGS (Design Center Rating System)**

Plate Voltage (Max.) ..... 250 Volts  
 Plate Dissipation (Max.) ..... 2.5 Watts  
 Cathode Current (Max.) ..... 25 Ma

**Grid Circuit Resistance**

Fixed Bias ..... Not recommended  
 Cathode Bias (Max.) ..... 0.5 Megohm

**CHARACTERISTICS AND TYPICAL OPERATION**

**Class A1 Amplifier**

Plate Supply Voltage ..... 150 Volts  
 Cathode Bias Resistor ..... 100 Ohms  
 Amplification Factor ..... 48  
 Plate Resistance ..... 4800 Ohms  
 Transconductance ..... 10,000 μmhos  
 Grid Bias for Ib = 10 μa ..... -10 Volts  
 Plate Current ..... 14.5 Ma

# 6BC7

## Color Television Type DC RESTORER or FM DISCRIMINATOR or AM DETECTOR

**Triple Diode**

Construction ..... Miniature T-6½  
 Base ..... Button 9 Pin, E9-1  
 Basing ..... 9AX  
 Outline ..... 6-2  
 Maximum Diameter ..... 0.875 In.  
 Maximum Seated Height ..... 1.938 In.  
 Maximum Overall Height ..... 2.188 In.

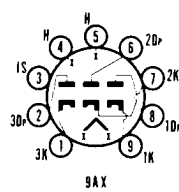

**ELECTRICAL DATA**

**HEATER OPERATION**

Heater Voltage.....	6.3 Volts
Heater Current .....	450 Ma
Maximum Heater-Cathode Voltage .....	200 Volts

**DIRECT INTERELECTRODE CAPACITANCES (Unshielded)**

Plate Diode No. 1 to All Other Elements .....	3.5 Pf
Plate Diode No. 2 to All Other Elements .....	5.5 Pf
Plate Diode No. 3 to All Other Elements .....	3.5 Pf

**RATINGS (Design Center Rating System) (Each Section)**

Peak Inverse Plate Voltage (Max.) .....	330 Volts
DC Output Current (Max.) .....	12 Ma
Peak Plate Current (Max.) .....	54 Ma

# 6BC8

4BC8

## Color Television Type VHF CASCODE AMPLIFIER

**Medium Mu, Semi-Remote  
Cutoff Twin Triode**

Construction ..... Miniature T-6½  
 Base ..... Button 9 Pin, E9-1  
 Basing ..... 9AJ  
 Outline ..... 6-2  
 Maximum Diameter ..... 0.875 In.  
 Maximum Seated Height ..... 1.938 In.  
 Maximum Overall Height ..... 2.188 In.

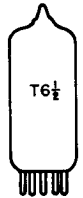
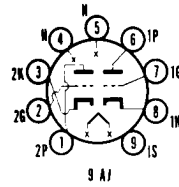

**ELECTRICAL DATA**

**HEATER OPERATION**

Heater Voltage.....	<b>4BC8</b>	<b>6BC8</b>
Heater Current .....	4.2	6.3 Volts
Heater Warm-up Time .....	600	400 Ma
Maximum Heater-Cathode Voltage .....	11	— Seconds

Heater Negative with Respect to Cathode <sup>(1)</sup>		200 Volts
Total DC and Peak.....		
Heater Positive with Respect to Cathode		
DC .....		100 Volts
Total DC and Peak.....		200 Volts

**DIRECT INTERELECTRODE CAPACITANCES (Shielded)<sup>(2)</sup>**

	<b>Section 1</b>	<b>Section 2</b>
Grid to Plate .....	1.2	1.2 Pf
Input .....	2.6	5.5 Pf
Output .....	1.3	2.4 Pf
Heater to Cathode .....	2.8	2.8 Pf
Plate Section No. 1 to Plate Section No. 2.....		0.02 Pf
Grid Section No. 1 to Grid Section No. 2 (Max.) .....		0.04 Pf

**RATINGS (Design Maximum Rating System) (Each Section)**

Plate Voltage (Max.) <sup>(1)</sup> .....	250 Volts
Plate Dissipation (Max.) .....	2.2 Watts
Cathode Current (Max.) .....	22 Ma
Grid Circuit Resistance (Max.) .....	0.5 Megohm

**CHARACTERISTICS AND TYPICAL OPERATION (Each Section)**

<b>Class A1 Amplifier</b>	
Plate Voltage .....	150 Volts

Grid Voltage .....	0 Volt
Cathode Bias Resistor .....	220 Ohms
Plate Current .....	10 Ma
Transconductance .....	6200 $\mu$ mhos
Plate Resistance.....	5300 Ohms
Amplification Factor .....	35
Grid Voltage for Gm = 50 $\mu$ mhos (Approx.) .....	-13 Volts

**NOTES:**

- (1) This rating may be as high as 300 volts max. under cutoff conditions when the tube is used as a cascade amplifier and the two sections are connected in series.
- (2) Shield No. 315.

**RF/IF AMPLIFIER**

**6BD6**  
12BD6

**Remote Cutoff Pentode**

Construction ..... Miniature T-5½  
 Base ..... Button 7 Pin, E7-1  
 Basing ..... 7BK  
 Outline ..... 5-2  
 Maximum Diameter ..... 0.750 In.  
 Maximum Seated Height ..... 1.875 In.  
 Maximum Overall Height ..... 2.125 In.

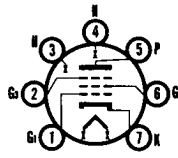

7BK

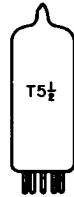

**ELECTRICAL DATA**

**HEATER OPERATION**

Heater Voltage.....	<b>12BD6</b> 12.6	<b>6BD6</b> 6.3 Volts
Heater Current .....	150	300 Ma
Maximum Heater-Cathode Voltage .....		90 Volts

**DIRECT INTERELECTRODE CAPACITANCES**

	<b>Shielded</b> (1)	<b>Unshielded</b>
Grid to Plate (Max.).....	0.005	0.004 Pf
Input .....	4.3	4.3 Pf
Output .....	5.0	5.0 Pf

**RATINGS (Design Center Rating System)**

Plate Voltage (Max.).....	300 Volts
Grid No. 2 Voltage (Max.) .....	125 Volts
Plate Dissipation (Max.) .....	4.0 Watts
Grid No. 2 Dissipation (Max.) .....	0.4 Watt
Cathode Current (Max.).....	14 Ma

**CHARACTERISTICS AND TYPICAL OPERATION**

**Class A1 Amplifier**

Plate Voltage .....	100	250 Volts
Grid No. 3 Voltage .....	(Connected to Cathode at Socket)	
Grid No. 2 Voltage .....	100	100 Volts
Grid No. 1 Voltage .....	-1	-3 Volts
Plate Current .....	13	9 Ma
Grid No. 2 Current .....	5	3.5 Ma
Transconductance .....	2350	2000 $\mu$ mhos
Plate Resistance.....	0.12	0.7 Megohm
E <sub>c1</sub> for Gm = 10 $\mu$ mhos (Approx.).....	-35	-35 Volts

**NOTE:**

- (1) With external Shield No. 316 connected to pin 7 (cathode).

**GENERAL PURPOSE AMPLIFIER (T)  
 SYNC SEPARATOR (T)  
 VIDEO AMPLIFIER (P)**

**6BD11**  
15BD11, 15BD11A

**High Mu Triode, Medium Mu Triode  
 and Sharp Cutoff Pentode**

Construction..... Compactron T-9  
 Base ..... Button 12 Pin, E12-70  
 Basing ..... 12DP  
 Outline ..... 9-58  
 Maximum Diameter ..... 1.188 In.  
 Maximum Seated Height ..... 2.000 In.  
 Maximum Overall Height ..... 2.375 In.

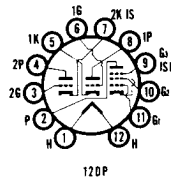

12DP

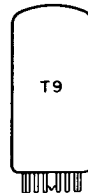

**ELECTRICAL DATA  
HEATER OPERATION**

	<b>15BD11 15BD11A</b>	<b>6BD11</b>
Heater Voltage.....	14.7	6.3 Volts
Heater Current .....	450	1050 Ma
Heater Warm-up Time .....	11	— Seconds
Maximum Heater-Cathode Voltage		
Heater Negative with Respect to Cathode		
Total DC and Peak.....		200 Volts
Heater Positive with Respect to Cathode		
DC Component .....		100 Volts
Total DC and Peak.....		200 Volts

**DIRECT INTERELECTRODE CAPACITANCES (Unshielded)**

**Triode (Section 1)**

Grid to Plate .....	1.9 Pf
Input: T1g to (1Tk + 2Tk + Pk + Pg3 + h + IS) .....	3.0 Pf
Output: T1p to (1Tk + 2Tk + Pk + Pg3 + h + IS) .....	2.2 Pf

**Triode (Section 2)**

Grid to Plate .....	3.6 Pf
Input: T2g to (2Tk + Pk + Pg3 + h + IS) .....	2.4 Pf
Output: T2p to (2Tk + Pk + Pg3 + h + IS) .....	3.8 Pf

**Pentode**

Grid No. 1 to Plate .....	0.13 Pf
Input: Pg1 to (2Tk + Pk + Pg2 + Pg3 + h + IS) .....	11 Pf
Output: Pp to (2Tk + Pk + Pg2 + Pg3 + h + IS) .....	4.6 Pf

**Coupling**

Pentode Plate to Triode Plate (Section 2) (Max.) .....	0.045 Pf
Triode Plate (Section 1) to Triode Plate (Section 2) (Max.) .....	0.075 Pf

**RATINGS (Design Maximum Rating System)**

**Triode No. 1**

Plate Voltage (Max.) .....	330 Volts
Positive DC Grid Voltage (Max.) .....	0 Volt
Plate Dissipation (Max.) .....	1.5 Watts
Grid Circuit Resistance	
With Fixed Bias (Max.) .....	0.5 Megohm
With Cathode Bias (Max.) .....	1.0 Megohm

**Triode No. 2**

Plate Voltage (Max.) .....	330 Volts
Positive DC Grid Voltage (Max.) .....	0 Volt
Plate Dissipation (Max.) .....	2.0 Watts
Grid Circuit Resistance	
With Fixed Bias (Max.) .....	0.5 Megohm
With Cathode Bias (Max.) .....	1.0 Megohm

**Pentode Section**

Plate Voltage (Max.) .....	330 Volts
Screen-Supply Voltage (Max.) .....	330 Volts
Screen Voltage .....	See Rating Chart (Gen. Info. Sec.)
Positive DC Grid No. 1 Voltage (Max.) .....	0 Volt
Plate Dissipation (Max.) .....	4.0 Watts
Screen Dissipation (Max.) .....	(15BD11A = 1.5) 1.1 Watts
Grid No. 1 Circuit Resistance	
With Fixed Bias (Max.) .....	1.0 Megohm
With Cathode Bias (Max.) .....	1.0 Megohm

**CHARACTERISTICS AND TYPICAL OPERATION**

**Triode No. 1**

Plate Voltage .....	200 Volts
Grid Voltage .....	-2.0 Volts
Amplification Factor .....	68
Plate Resistance (Approx.) .....	12,400 Ohms
Transconductance .....	5500 $\mu$ mhos
Plate Current .....	7.0 Ma
Grid Voltage (Approx.)	
Ib = 100 $\mu$ a .....	-5.5 Volts

**Triode No. 2**

Plate Voltage .....	200 Volts
Cathode-Bias Resistor .....	220 Ohms
Amplification Factor .....	41
Plate Resistance (Approx.) .....	9400 Ohms
Transconductance .....	4400 $\mu$ mhos
Plate Current .....	9.2 Ma
Grid Voltage (Approx.)	
Ib = 100 $\mu$ a .....	-6.5 Volts

**Pentode Section**

Plate Voltage .....	35	135 Volts
Screen Voltage .....	135	135 Volts
Grid No. 1 Voltage <sup>(1)</sup> .....	0	— Volt
Cathode Bias Resistor .....	—	100 Ohms

Plate Resistance (Approx.) .....	—	45,000 Ohms
Transconductance .....	—	10,400 $\mu$ mhos
Plate Current .....	34	17 Ma
Screen Current .....	13	4.0 Ma
Grid No. 1 Voltage (Approx.) I <sub>b</sub> = 100 $\mu$ a .....	—	-6 Volts

**NOTE:**

(1) Applied for short interval (two seconds maximum) so as not to damage tube.

Color Television Type  
**DAMPER**

**6BE3A**  
12BE3A, 17BE3A

**Heater-Cathode Diode**

Construction..... Compactron T-9  
 Base ..... Button 12 Pin, E12-70  
 Basing ..... 12GA  
 Outline ..... 9-60  
     Maximum Diameter ..... 1.188 In.  
     Maximum Seated Height ..... 2.500 In.  
     Maximum Overall Height ..... 2.875 In.

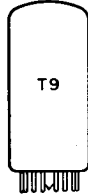
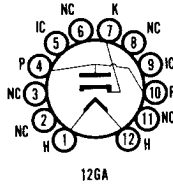

**ELECTRICAL DATA  
HEATER OPERATION**

	17BE3A	12BE3A	6BE3A
Heater Voltage.....	16.8	12.6	6.3 Volts
Heater Current .....	450	600	1200 Ma
Heater Warm-up Time .....	11	11	— Seconds
Maximum Heater-Cathode Voltage			
Heater Negative with Respect to Cathode			
DC .....			900 Volts
Total DC and Peak.....			5000 Volts
Heater Positive with Respect to Cathode			
DC .....			100 Volts
Total DC and Peak.....			300 Volts

**DIRECT INTERELECTRODE CAPACITANCES (Unshielded)**

Heater to Cathode .....	3.4 Pf
Plate to Cathode and Heater.....	8.0 Pf
Cathode to Plate and Heater.....	10 Pf

**RATINGS (Design Maximum Rating System)**

**Damper Service**

Peak Inverse Plate Voltage <sup>(1)</sup> (Max.) .....	5000 Volts
Plate Dissipation (Max.) .....	6.5 Watts
Steady State Peak Current (Max.) .....	1200 Ma
DC Plate Current (Max.) .....	200 Ma

**CHARACTERISTICS AND TYPICAL OPERATION**

Tube Voltage Drop for I <sub>b</sub> = 350 Ma DC.....	22.5 Volts
---	------------

**NOTE:**

(1) For operation in a 525 line, 30 frame system as described in "Standards of Good Engineering Practice for Television Broadcast Stations; Federal Communications Commission," the duty cycle of the voltage pulse must not exceed 15% of one horizontal scanning cycle.

**AM/FM PENTAGRID CONVERTER**

**6BE6**  
3BE6, 4BE6, 12BE6

**Heptode**

Construction ..... Miniature T-5½  
 Base ..... Button 7 Pin, E7-1  
 Basing ..... 7CH  
 Outline ..... 5-2  
     Maximum Diameter ..... 0.750 In.  
     Maximum Seated Height ..... 1.875 In.  
     Maximum Overall Height ..... 2.125 In.

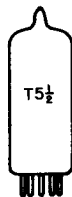
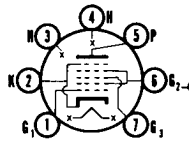

7 CH

**ELECTRICAL DATA**

**HEATER OPERATION**

	<b>3BE6</b>	<b>4BE6</b>	<b>12BE6</b>	<b>6BE6</b>
Heater Voltage.....	3.15	4.2	12.6	6.3 Volts
Heater Current.....	600	450	150	300 Ma
Heater Warm-up Time .....	11	11	—	— Seconds
Maximum Heater-Cathode Voltage				
Heater Negative with Respect to Cathode				
Total DC and Peak.....				200 Volts
Heater Positive with Respect to Cathode				
DC .....				100 Volts
Total DC and Peak.....				200 Volts

**DIRECT INTERELECTRODE CAPACITANCES**

	<b>Shielded <sup>(2)</sup></b>	<b>Unshielded</b>
Grid No. 3 to Plate (Max.).....	0.25	0.30 Pf
Grid No. 3 to Grid No. 1 (Max.).....	0.15	0.15 Pf
Grid No. 3 Input: g3 to (h+k+g1+g2+g4+g5+p)	7.0	7.0 Pf
Grid No. 1 Input: g1 to (h+k+g2+g4+g3+g5+p)	5.5	5.5 Pf
Output: p to (h+k+g1+g2+g4+g3+g5).....	13.0	8.0 Pf
Grid No. 1 to Cathode.....	3.0	3.0 Pf
Grid No. 1 to Plate .....	0.05	0.1 Pf
Cathode to All Electrodes Except Grid No. 1 .....	20.0	15.0 Pf

**RATINGS (Design Center Rating System)**

Plate Voltage (Max.) .....		300 Volts
Plate Dissipation (Max.) .....		1.0 Watt
Grid No. 2 Voltage (Max.) .....		100 Volts
Grid No. 2 Supply Voltage (Max.) .....		300 Volts
Grid No. 2 Dissipation (Max.) .....		1.0 Watt
Positive Grid No. 3 Voltage (Max.) .....		0 Volt
Negative Grid No. 3 Voltage (Max.) .....		50 Volts
Cathode Current (Max.).....		14 Ma

**CHARACTERISTICS AND TYPICAL OPERATION**

**Separate Excitation<sup>(2)</sup>**

Plate Voltage .....	100	250 Volts
Grid No. 2 Voltage .....	100	100 Volts
Grid No. 3 Voltage .....	-1.5	-1.5 Volts
Grid No. 1 Resistance .....	20,000	20,000 Ohms
Grid No. 1 Current .....	0.5	0.5 Ma
Conversion Transconductance .....	455	475 $\mu$ mhos
Plate Resistance (Approx.) .....	0.4	1.0 Megohm
Plate Current .....	2.6	2.9 Ma
Grid No. 2 Current .....	7.0	6.8 Ma
Cathode Current .....	10.1	10.2 Ma
Grid No. 3 Voltage (Approx.) for Gc = 10 $\mu$ mhos .....	-30	-30 Volts

**Oscillator Section Characteristics (non-Oscillating)**

Grid No. 3 Voltage .....		0 Volt
Grid No. 1 Voltage .....		0 Volt
Grid No. 2 Connected to Plate .....		100 Volts
Cathode Current .....		25 Ma
Transconductance Between Grid No. 1 and		
Grid No. 2 Connected to Plate .....		7250 $\mu$ mhos
Amplification Factor .....		20
Grid No. 3 Voltage (Approx.) for Ib = 10 $\mu$ a .....		-11 Volts

**NOTES:**

- (1) Shield No. 316 connected to cathode.
- (2) Data for self-excitation in a zero bias circuit corresponds very closely to that for separate excitation.

# 6BF11

12BF11, 17BF11, 24BF11

*Color Television Type*

## AUDIO POWER AMPLIFIER FM DETECTOR

**Beam Pentode and Sharp Cutoff Pentode**

Construction..... Compactron T-9  
 Base ..... Button 12 Pin, E12-70  
 Basing ..... 12EZ  
 Outline ..... 9-59  
 Maximum Diameter ..... 1.188 In.  
 Maximum Seated Height ..... 2.250 In.  
 Maximum Overall Height ..... 2.625 In.

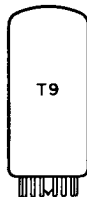
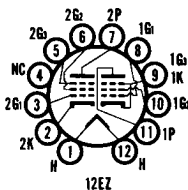

**ELECTRICAL DATA  
HEATER OPERATION**

	<b>24BF11</b>	<b>17BF11</b>	<b>12BF11</b>	<b>6BF11</b>
Heater Voltage.....	24.2	16.8	12.6	6.3 Volts
Heater Current .....	315	450	600	1200 Ma
Heater Warm-up Time .....	11	11	11	— Seconds
Maximum Heater-Cathode Voltage				
Heater Negative with Respect to Cathode				
Total DC and Peak.....				200 Volts
Heater Positive with Respect to Cathode				
DC .....				100 Volts
Total DC and Peak.....				200 Volts

**DIRECT INTERELECTRODE CAPACITANCES (Unshielded)  
Section No. 1 (Power Amplifier)**

Grid to Plate .....	0.24 Pf
Input: g to (h + 1k + 1g2 + 1g3 + 1S).....	13.0 Pf
Output: p to (h + 1k + 1g2 + 1g3 + 1S).....	10.0 Pf

**Section No. 2 (FM Detector)**

Grid No. 1 to Plate (Max.).....	0.036 Pf
Grid No. 3 to Plate .....	3.2 Pf
Grid No. 1 to (h + 2k + 2g2 + 2g3 + 1S).....	6.5 Pf
Grid No. 3 to (h + 2k + 2g2 + 2g3 + 2p + 1S).....	8.0 Pf
Grid No. 1 to Grid No. 3 .....	0.11 Pf
Plate No. 1 to Plate No. 2 .....	0.13 Pf

**RATINGS (Design Maximum Rating System)**

**Section No. 1 (Power Amplifier)**

Plate Voltage (Max.) .....	165 Volts
Screen Voltage (Max.) .....	150 Volts
Plate Dissipation (Max.) .....	6.5 Watts
Screen Dissipation (Max.) .....	1.8 Watts
DC Cathode Current (Max.) .....	65 Ma
Grid No. 1 Circuit Resistance	
Fixed Bias (Max.) .....	0.25 Megohm
Cathode Bias (Max.) .....	0.5 Megohm

**Section No. 2 (FM Detector)**

Plate Voltage (Max.) .....	330 Volts
Suppressor Voltage (Max.).....	28 Volts
Screen Supply Voltage (Max.).....	330 Volts
Positive DC Grid Voltage (Max.).....	0 Volt
Plate Dissipation (Max.) .....	1.7 Watts
Screen Dissipation (Max.) .....	1.1 Watts

**CHARACTERISTICS AND TYPICAL OPERATION**

**Section No. 1**

**Class A1 Amplifier (Power Amplifier)**

Plate Voltage .....	145 Volts
Screen Voltage.....	110 Volts
Grid No. 1 Voltage .....	-6.0 Volts
Peak AF Grid Voltage .....	6.0 Volts
Plate Resistance (Approx.) .....	30,000 Ohms
Transconductance .....	8600 $\mu$ mhos
Zero Signal Plate Current .....	36 Ma
Maximum Signal Plate Current .....	40 Ma
Zero Signal Screen Current .....	3.0 Ma
Maximum Signal Screen Current .....	9.0 Ma
Load Resistance .....	3000 Ohms
Total Harmonic Distortion (Approx.).....	10 Percent
Maximum Signal Power Output .....	2.4 Watts

**Section No. 2 (FM Detector)**

Plate Voltage .....	150 Volts
Suppressor Voltage .....	0 Volt
Screen Voltage .....	100 Volts
Cathode Resistor .....	560 Ohms
Plate Resistance (Approx.) .....	150,000 Ohms
Transconductance (G1) .....	1000 $\mu$ mhos
Transconductance (G3) .....	400 $\mu$ mhos
Plate Current .....	1.3 Ma
Screen Current .....	2.1 Ma
E <sub>c1</sub> for I <sub>b</sub> = 30 $\mu$ a .....	-4.5 Volts
E <sub>c3</sub> for I <sub>b</sub> = 50 $\mu$ a .....	-4.5 Volts

**6BH3**  
17BH3, 22BH3

**DAMPER**

**Heater-Cathode Diode**

Construction .....Novar T-9  
 Base .....Button 9 Pin, E9-75  
 Basing<sup>(1)</sup> .....9HP  
 Outline .....9-86  
 Maximum Diameter .....1.188 In.  
 Maximum Seated Height .....3.030 In.  
 Maximum Overall Height .....3.410 In.

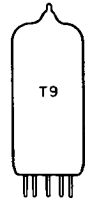
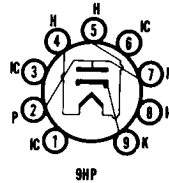

**ELECTRICAL DATA**

**HEATER OPERATION**

	<b>22BH3</b>	<b>17BH3</b>	<b>6BH3</b>
Heater Voltage.....	22.4	17	6.3 Volts
Heater Current .....	450	600	1600 Ma
Heater Warm-up Time .....	11	11	— Seconds
Maximum Heater-Cathode Voltage			
Heater Negative with Respect to Cathode			
DC .....			900 Volts
Total DC and Peak.....			5500 Volts
Heater Positive with Respect to Cathode			
DC .....			100 Volts
Total DC and Peak.....			300 Volts

**DIRECT INTERELECTRODE CAPACITANCES (Unshielded)**

Heater to Cathode .....	2.8 Pf
Plate to Cathode and Heater.....	6.5 Pf
Cathode to Plate and Heater.....	9.0 Pf

**RATINGS (Design Maximum Rating System)**

**Damper Service**

Peak Inverse Plate Voltage (Max.) <sup>(2)</sup> .....	5500 Volts
Plate Dissipation (Max.) .....	6.5 Watts
Steady State Peak Current (Max.) .....	1100 Ma
DC Plate Current (Max.) .....	180 Ma

**NOTES:**

- (1) Pins 1, 3, 6, and 8 should not be used as tie points.
- (2) For operation in a 525 line, 30 frame system as described in "Standards of Good Engineering Practice for Television Broadcast Stations; Federal Communications Commission," the duty cycle of the voltage pulse must not exceed 15% of one horizontal scanning cycle.

**6BH3A**  
17BH3A, 22BH3A

**DAMPER**

**Heater-Cathode Diode**

Construction .....Novar T-9  
 Base .....Button 9 Pin, E9-89  
 Basing .....9HP  
 Outline .....9-86  
 Maximum Diameter .....1.188 In.  
 Maximum Seated Height .....2.625 In.  
 Maximum Overall Height .....3.005 In.  
 6BH3A, 17BH3A, and 22BH3A are identical to 6BH3, 17BH3, and 22BH3 except for base with exhaust tip at bottom and shorter bulb.

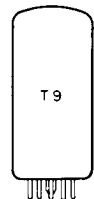
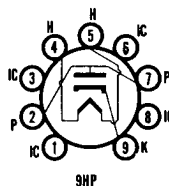



**RF AMPLIFIER**

**6BH6**

**Sharp Cutoff Pentode**

Construction ..... Miniature T-5½  
 Base ..... Button 7 Pin, E7-1  
 Basing ..... .7CM  
 Outline ..... 5-2  
 Maximum Diameter ..... 0.750 In.  
 Maximum Seated Height ..... 1.865 In.  
 Maximum Overall Height ..... 2.125 In.

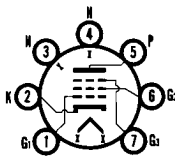

7CM

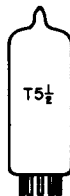

**ELECTRICAL DATA**

**HEATER OPERATION**

Heater Voltage ..... 6.3 Volts  
 Heater Current ..... 150 Ma  
 Maximum Heater-Cathode Voltage ..... 90 Volts

**DIRECT INTERELECTRODE CAPACITANCES**

	<b>Shielded</b>	<b>Unshielded</b>
Grid to Plate (Max.) .....	0.0035	0.0035 Pf
Input (Max.) .....	5.4	5.4 Pf
Output (Max.) .....	4.4	4.4 Pf

**RATINGS (Design Center Rating System)**

Plate Voltage (Max.) ..... 300 Volts  
 Grid No. 2 Supply Voltage (Max.) ..... 300 Volts  
 Grid No. 2 Voltage ..... See Rating Chart (Gen. Info. Sec.)  
 Plate Dissipation (Max.) ..... 3 Watts  
 Grid No. 2 Dissipation (Max.) ..... 0.5 Watt  
 Negative Grid No. 1 Voltage (Max.) ..... 50 Volts  
 Positive Grid No. 1 Voltage (Max.) ..... 0 Volt

**CHARACTERISTICS AND TYPICAL OPERATION**

**Class A1 Amplifier**

Plate Voltage .....	100	250 Volts
Grid No. 3 Voltage .....	Connected to Cathode at Socket	
Grid No. 2 Voltage .....	100	150 Volts
Grid No. 1 Voltage .....	-1.0	-1.0 Volt
Cathode Bias Resistor .....	200	95 Ohms
Plate Current .....	3.6	7.4 Ma
Grid No. 2 Current .....	1.4	2.9 Ma
Transconductance .....	3400	4600 μmhos
Plate Resistance (Approx.) .....	0.7	1.4 Megohms
Grid No. 1 Voltage for Ib = 10 μa .....	-5.0	-7.7 Volts

*Color Television Type*

**SYNC SEP./CLIPPER/AMP.  
 or SWEEP OSC. (T)  
 VIDEO AMPLIFIER (P)**

**6BH8**

8BH8

**Medium Mu Triode and  
 Sharp Cutoff Pentode**

Construction ..... Miniature T-6½  
 Base ..... Button 9 Pin, E9-1  
 Basing ..... 9DX  
 Outline ..... 6-3  
 Maximum Diameter ..... 0.875 In.  
 Maximum Seated Height ..... 2.375 In.  
 Maximum Overall Height ..... 2.625 In.

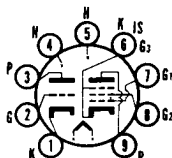

9DX

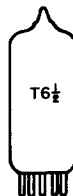

**ELECTRICAL DATA**

**HEATER OPERATION**

	<b>8BH8</b>	<b>6BH8</b>
Heater Voltage .....	8.4	6.3 Volts
Heater Current .....	450	600 Ma
Heater Warm-up Time .....	11	11 Seconds

<b>Maximum Heater-Cathode Voltage</b>	
Heater Negative with Respect to Cathode	
Total DC and Peak.....	200 Volts
Heater Positive with Respect to Cathode	
DC .....	100 Volts
Total DC and Peak.....	200 Volts

**DIRECT INTERELECTRODE CAPACITANCES (Unshielded)**

<b>Triode</b>	
Grid to Plate .....	2.4 Pf
Input .....	2.6 Pf
Output .....	0.38 Pf
<b>Pentode</b>	
Grid to Plate .....	0.046 Pf
Input .....	7.0 Pf
Output .....	2.4 Pf
<b>Coupling</b>	
Pentode Grid No. 1 to Triode Plate .....	0.004 Pf
Triode Grid to Pentode Plate .....	0.016 Pf
Pentode Plate to Triode Plate .....	0.095 Pf

**RATINGS (Design Center Rating System)**

	<b>Triode</b>	<b>Pentode</b>
Plate Voltage (Max.) .....	300	300 Volts
Grid No. 2 Supply Voltage (Max.) .....	—	300 Volts
Grid No. 2 Voltage .....	See Rating Chart (Gen. Info. Sec.)	
Plate Dissipation (Max.) .....	2.5	3.0 Watts
Grid No. 2 Dissipation (Max.) .....	—	1.0 Watt
Grid No. 1 Circuit Resistance		
Fixed Bias (Max.) .....	0.5	0.25 Megohm
Self Bias (Max.) .....	1.0	1.0 Megohm

**CHARACTERISTICS AND TYPICAL OPERATION**

**Class A1 Amplifier**

	<b>Triode</b>	<b>Pentode</b>
Plate Voltage .....	150	200 Volts
Grid No. 2 Voltage .....	—	125 Volts
Grid No. 1 Voltage .....	-5	— Volts
Cathode Bias Resistor .....	—	82 Ohms
Amplification Factor .....	17	—
Plate Resistance (Approx.) .....	5150	150,000 Ohms
Transconductance .....	3300	7000 $\mu$ mhos
Plate Current .....	9.5	15 Ma
Grid No. 2 Current .....	—	3.4 Ma
Grid No. 1 Voltage (Approx.)		
For $I_b = 100 \mu$ a.....	-14	-8 Volts

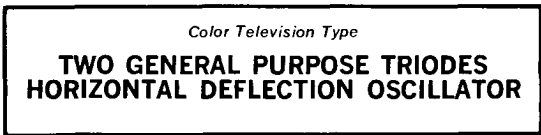

**Double Medium Mu Triode  
and Sharp Cutoff Pentode**

Construction.....	Compactron T-9
Base .....	Button 12 Pin, E12-70
Basing .....	12FP
Outline .....	9-58
Maximum Diameter .....	1.188 In.
Maximum Seated Height .....	2.000 In.
Maximum Overall Height .....	2.375 In.

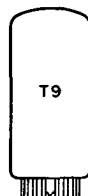
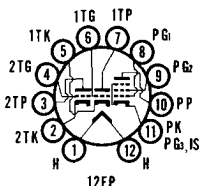

**ELECTRICAL DATA**

<b>HEATER OPERATION</b>	
Heater Voltage.....	6.3 Volts
Heater Current .....	800 Ma
<b>Maximum Heater-Cathode Voltage</b>	
Heater Positive with Respect to Cathode	
DC Component .....	100 Volts
Total DC and Peak.....	200 Volts
Heater Negative with Respect to Cathode	
Total DC and Peak.....	200 Volts

**DIRECT INTERELECTRODE CAPACITANCES (Unshielded)**

**Triode (Section 1)**

Grid to Plate: (T1g to T1p) .....	1.7 Pf
Input: T1g to (T1k + Pk + Pg3 + IS) .....	3.2 Pf
Output: T1p to (T1k + Pk + Pg3 + IS) .....	1.4 Pf

**Triode (Section 2)**

Grid to Plate: (T2g to T2p) .....	1.8 Pf
Input: T2g to (T2k + Pk + Pg3 + IS) .....	3.0 Pf
Output: T2p to (T2k + Pk + Pg3 + IS) .....	0.6 Pf

**Pentode Section**

Grid No. 1 to Plate: (Pg2 to Pp) .....	0.11 Pf
Input: Pp1 to (Pk + Pg2 + Pg3 + IS) .....	5.5 Pf
Output: Pp to (Pk + Pg2 + Pg3 + IS) .....	2.2 Pf

**RATINGS (Design Maximum Rating System)**

	<b>Pentode Section Horiz. Osc. Service<sup>(1)</sup></b>	<b>Each Triode Section</b>
DC Plate Voltage (Max.) .....	350	330 Volts
Screen Supply Voltage (Max.) .....	330	— Volts
Screen Voltage (Max.) .....	See Rating Chart (Gen. Info. Sec.)	
Positive DC Grid No. 1 Voltage (Max.) .....	0	0 Volt
Peak Negative Grid No. 1 Voltage (Max.) .....	175	— Volts
Plate Dissipation (Max.) .....	2.5	2.5 Watts
Screen Dissipation (Max.) .....	0.55	— Watt
DC Cathode Current (Max.) .....	20	— Ma
Peak Cathode Current (Max.) .....	300	— Ma
Grid No. 1 Circuit Resistance		
With Fixed Bias (Max.) .....	2.2	2.2 Megohms
With Cathode Bias (Max.) .....	2.2	2.2 Megohms

**CHARACTERISTICS AND TYPICAL OPERATION**

	<b>Pentode Section</b>	<b>Each Triode Section</b>
Plate Voltage .....	125	125 Volts
Screen Voltage .....	125	— Volts
Grid No. 1 Voltage .....	-1.0	-1.0 Volt
Amplification Factor .....	—	46
Plate Resistance (Approx.) .....	200,000	5400 Ohms
Transconductance .....	7500	8500 $\mu$ mhos
Plate Current .....	12	13.5 Ma
Screen Current .....	4.0	— Ma
Grid No. 1 Voltage (Approx.) .....		
Ib = 10 $\mu$ a .....	-8	-8 Volts

**NOTE:**

(1) For operation in a 525 line, 30 frame system as described in "Standards of Good Engineering Practice for Television Broadcast Stations; Federal Communications Commission," the duty cycle of the voltage pulse must not exceed 15% of one horizontal scanning cycle.



**Heater-Cathode Diode**

Construction .....	Compactron T-9
Base .....	Button 12 Pin, E12-70
Basing <sup>(1)</sup> .....	12BL
Outline .....	9-59
Maximum Diameter .....	1.188 In.
Maximum Seated Height .....	2.250 In.
Maximum Overall Height .....	2.625 In.

**ELECTRICAL DATA**

**HEATER OPERATION**

Heater Voltage .....	6.3 Volts
Heater Current .....	1200 Ma
Maximum Heater Cathode Voltage	
Heater Negative with Respect to Cathode	
DC .....	600 Volts
Total DC and Peak .....	3300 Volts
Heater Positive with Respect to Cathode	
DC .....	100 Volts
Total DC and Peak .....	300 Volts

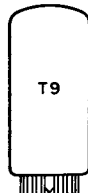
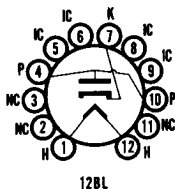

**DIRECT INTERELECTRODE CAPACITANCES (Unshielded)**

Heater to Cathode .....	2.7 Pf
Plate to Cathode and Heater.....	5.5 Pf
Cathode to Plate and Heater.....	8.0 Pf

**RATINGS (Design Maximum Rating System)**

**Damper Service**

Peak Inverse Plate Voltage <sup>(2)</sup> (Max.) .....	3300 Volts
Plate Dissipation (Max.) .....	4 Watts
Steady State Peak Current (Max.) .....	840 Ma
DC Plate Current (Max.) .....	140 Ma

**CHARACTERISTICS AND TYPICAL OPERATION**

Tube Voltage Drop for Ib = 250 Ma .....	21 Volts
---	----------

**NOTES:**

- (1) Pin 5, 6, 8, and 9 should not be used as tie points.
- (2) For operation in a 525 line, 30 frame system as described in "Standards of Good Engineering Practice for Television Broadcast Stations; Federal Communications Commission," the duty cycle of the voltage pulse must not exceed 15% of one horizontal scanning cycle.



**Remote Cutoff Pentode**

- Construction ..... Miniature T-5½
- Base ..... Button 7 Pin, E7-1
- Basing ..... 7CM
- Outline ..... 5-2
- Maximum Diameter ..... 0.750 In.
- Maximum Seated Height ..... 1.875 In.
- Maximum Overall Height ..... 2.125 In.

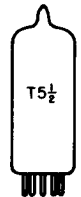
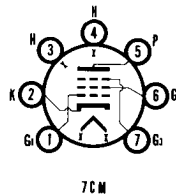

**ELECTRICAL DATA**

**HEATER OPERATION**

Heater Voltage.....	6.3 Volts
Heater Current .....	150 Ma
Maximum Heater-Cathode Voltage .....	90 Volts

**DIRECT INTERELECTRODE CAPACITANCES**

	Shielded <sup>(1)</sup>	Unshielded
Grid No. 1 to Plate (Max.).....	0.0035	0.0035 Pf
Input: g1 to (h + k + g2 + g3 + IS).....	4.5	4.5 Pf
Output: p to (h + k + g2 + g3 + IS).....	5.5	5.5 Pf

**RATINGS (Design Center Rating System)**

Plate Voltage (Max.) .....	300 Volts
Grid No. 2 Supply Voltage (Max.) .....	300 Volts
Grid No. 2 Voltage .....	See Rating Chart (Gen. Info. Sec.)
Positive Grid No. 1 Voltage (Max.) .....	0 Volt
Negative Grid No. 1 Voltage (Max.) .....	50 Volts
Plate Dissipation (Max.) .....	3.0 Watts
Grid No. 2 Dissipation (Max.) .....	0.6 Watt

**CHARACTERISTICS AND TYPICAL OPERATION**

**Class A1 Amplifier**

Plate Voltage .....	100	250 Volts
Grid No. 2 Voltage .....	100	100 Volts
Grid No. 3 Voltage .....	Connected to Cathode at Socket	
Grid No. 1 Voltage .....	-1.0	-1.0 Volt
Plate Current .....	9	9.2 Ma
Grid No. 2 Current .....	3.5	3.3 Ma
Transconductance .....	3650	3600 μmhos
Plate Resistance.....	0.25	1.3 Megohms
Ec1 for Gm = 10 μmhos (Approx.) .....	-20	-20 Volts

**NOTE:**

- (1) Shield No. 306 connected to Pins 2 and 7.

**6BJ6A (only)**

The 6BJ6A, except for controls on formation of interface impedance, is identical to Type 6BJ6. The interface impedance control consists of a life test conducted for 500 hours with the filament operating with 6.9 volts imposed. The other tube elements are unconnected simulating operation at cutoff conditions. Following life test the sample tubes are measured at conditions Ef = 5.7 V; Eb = Ec2 = Ec3 = 70 V DC; and Ec1 adjusted for Ib = 4.0 Ma DC. The maximum allowable value for interface impedance is 70 Ohms.

Color Television Type  
**DC RESTORER**

**6BJ7**

**Triple Diode**

Construction ..... Miniature T-6½  
 Base ..... Button 9 Pin, E9-1  
 Basing ..... 9AX  
 Outline ..... 6-2  
 Maximum Diameter ..... 0.875 In.  
 Maximum Seated Height ..... 1.937 In.  
 Maximum Overall Height ..... 2.187 In.

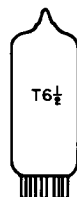
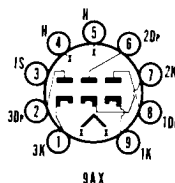

**ELECTRICAL DATA**

**HEATER OPERATION**

Heater Voltage .....	6.3 Volts
Heater Current .....	450 Ma
Maximum Heater-Cathode Voltage	
Heater Positive with Respect to Cathode .....	100 Volts
Heater Negative with Respect to Cathode .....	330 Volts

**DIRECT INTERELECTRODE CAPACITANCES (Unshielded)**

Plate No. 1 to Cathode No. 1, Heater and Internal Shield .....	3.0 Pf
Plate No. 2 to Cathode No. 2, Heater and Internal Shield .....	2.6 Pf
Plate No. 3 to Cathode No. 3, Heater and Internal Shield .....	2.6 Pf
Cathode No. 1 to Plate No. 1, Heater and Internal Shield .....	4.0 Pf
Cathode No. 2 to Plate No. 2, Heater and Internal Shield .....	3.8 Pf
Cathode No. 3 to Plate No. 3, Heater and Internal Shield .....	4.0 Pf
Plate No. 1 to Plate No. 2 .....	0.055 Pf
Plate No. 2 to Plate No. 3 .....	0.036 Pf
Plate No. 3 to Plate No. 1 .....	0.036 Pf

**RATINGS (Design Center Rating System)**

**Television DC-Restorer Service**

Peak Inverse Plate Voltage (Max.) .....	330 Volts
Peak Plate Current Per Plate (Max.) .....	10 Ma
DC Output Current Per Plate (Max.) .....	1.0 Ma

**CHARACTERISTICS AND TYPICAL OPERATION**

Tube Voltage Drop (Each Section) for Ib = 10 Ma DC .....	2.7 Volts
--	-----------

Color Television Type  
**PHASE SPLITTER/COMPARATOR  
VERTICAL DEFLECTION AMPLIFIER**

**6BJ8**

**Double Diode and Medium Mu Triode**

Construction ..... Miniature T-6½  
 Base ..... Button 9 Pin, E9-1  
 Basing ..... 9ER  
 Outline ..... 6-3  
 Maximum Diameter ..... 0.875 In.  
 Maximum Seated Height ..... 2.375 In.  
 Maximum Overall Height ..... 2.625 In.

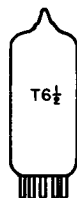
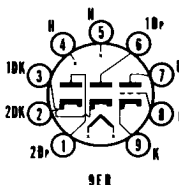

**ELECTRICAL DATA**

**HEATER OPERATION**

Heater Voltage .....	6.3 Volts
Heater Current .....	600 Ma
Heater Warm-up Time .....	11 Seconds
Maximum Heater-Cathode Voltage	

Heater Negative with Respect to Cathode	
Total DC and Peak .....	200 Volts
Heater Positive with Respect to Cathode	
DC .....	100 Volts
Total DC and Peak .....	200 Volts

**DIRECT INTERELECTRODE CAPACITANCES (Unshielded)**

**Diode Section**

No. 1 Diode Plate to No. 1 Diode	
Cathode + Heater .....	1.9 Pf

No. 2 Diode Plate to No. 2 Diode Cathode + Heater .....	1.9 Pf
No. 1 Diode Cathode to No. 1 Diode Plate + Heater .....	4.6 Pf
No. 2 Diode Cathode to No. 2 Diode Plate + Heater .....	4.6 Pf
<b>Triode Section</b>	
Grid to Plate .....	2.6 Pf
Input: g to (h + Tk) .....	2.8 Pf
Output: p to (h + Tk) .....	0.31 Pf
<b>Coupling</b>	
No. 1 Diode Plate to Triode Grid (Max.).....	0.070 Pf
No. 2 Diode Plate to Triode Grid (Max.).....	0.11 Pf
No. 1 Diode Cathode to All:	
1 Dk to (h + Tk + 2Dk + Tp + 1Dp + Tg + 2Dp) .....	4.8 Pf
No. 2 Diode Cathode to All:	
2DK to (h + Tk + 1Dk + Tp + 1Dp + 2Dp + Tg) .....	4.8 Pf
No. 1 Diode Plate to No. 2 Diode Plate (Max.).....	0.060 Pf
No. 1 Diode Plate to All:	
1DP to (h + Tk + 1Dk + 2Dk + Tp + 2Dp + Tg) .....	3.0 Pf
No. 2 Diode Plate to All:	
2DP to (h + Tk + 1Dk + 2Dk + Tp + 1Dp + Tg) .....	3.0 Pf
<b>RATINGS (Design Maximum Rating System)</b>	

	Class A1 Amplifier	Vert. Def. Amplifier <sup>(1)</sup>
<b>Triode Section</b>		
Plate Voltage (Max.) .....	330	330 Volts
Peak Positive Pulse Plate Voltage (Abs. Max.).....	—	1200 Volts
Peak Negative Pulse Grid Voltage (Max.) .....	—	275 Volts
Positive DC Grid Voltage (Max.) .....	0	— Volt
Maximum Plate Dissipation <sup>(2)</sup> (Max.) .....	4.0	4.0 Watts
Average Cathode Current (Max.).....	22	22 Ma
Peak Cathode Current (Max.) .....	—	77 Ma
Grid Circuit Resistance		
Self Bias (Max.) .....	1.0	2.2 Megohms
Fixed Bias (Max.) .....	1.0	— Megohms
<b>Diode Section</b>		
Peak Plate Current (Each Plate) (Max.).....	—	54 Ma
DC Current (Each Plate) (Max.) .....	—	9 Ma

**CHARACTERISTICS AND TYPICAL OPERATION**

<b>Triode Section</b>		
<b>Class A1 Amplifier</b>		
Plate Voltage .....	90	250 Volts
Grid Voltage .....	0	-9 Volts
Plate Current .....	13.5	8.0 Ma
Transconductance .....	4700	2800 $\mu$ mhos
Amplification Factor .....	22	20
Plate Resistance (Approx.) .....	4700	7150 Ohms
Plate Current at $E_c = -12.5$ Volts DC .....	—	1.7 Ma
<b>Diode Section</b>		
Average Current Each Plate at 10 Volts DC <sup>(3)</sup> .....		50 Ma
Voltage Drop Each Section at $I_b = 9$ Ma DC .....		2.6 Volts

**NOTES:**

- (1) For operation in a 525 line, 30 frame system as described in "Standards of Good Engineering Practice for Television Broadcast Stations; Federal Communications Commission," the duty cycle of the voltage pulse must not exceed 15% of one horizontal scanning cycle.
- (2) In stages operating with grid leak bias, an adequate cathode bias resistor or other suitable means is required to protect the tube in the absence of excitation.
- (3) Test conditions only.



**Sharp Cutoff Beam Pentode**

Construction .....	Octal T-12
Base .....	B8-71 or B8-118
Top Cap .....	Small C1-1 or C1-34
Basing .....	8MW
Outline .....	12-36
Maximum Diameter .....	1.720 In.
Maximum Seated Height .....	4.438 In.
Maximum Overall Height .....	5.000 In.

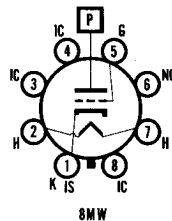

**ELECTRICAL DATA**

**HEATER OPERATION**

Heater Voltage.....	6.3 Volts
Heater Current .....	200 Ma
Maximum Heater-Cathode Voltage	
Heater Negative with Respect to Cathode .....	450 Volts
Heater Positive with Respect to Cathode .....	Not Recommended

**DIRECT INTERELECTRODE CAPACITANCES (Unshielded)**

Grid to Plate .....	1.0 Pf
Input .....	2.6 Pf
Output (Max.).....	1.0 Pf

**RATINGS (Design Maximum Rating System)**

**Voltage Control Service**

DC Plate Voltage (Abs. Max.) .....	27,000 Volts
Unregulated DC Supply Voltage (Abs. Max.) .....	60,000 Volts
Grid Voltage	

DC (Max.) .....	-135 Volts
Peak (Max.) <sup>(1)</sup> .....	-440 Volts
DC Plate Current (Abs. Max.) .....	1.6 Ma
Plate Dissipation (Max.) .....	40 Watts
Grid Circuit Resistance (Abs. Max.) <sup>(2)</sup> .....	3 Megohms

**CHARACTERISTICS AND TYPICAL OPERATION**

**Shunt Voltage Regulator**

Unregulated Supply	
DC Voltage.....	36,000 Volts
Equivalent Resistance .....	11 Megohms

**Voltage Divider Values**

R1 (5 Watts).....	220 Megohms
R2 (2 Watts).....	1 Megohm
R3 (½ Watt) .....	0.82 Megohm

**Reference Voltage Supply**

DC Value.....	200 Volts
Equivalent Resistance .....	1000 Ohms
Effective Grid-Plate Transconductance .....	200 $\mu$ hos

**DC Plate Current**

For Load Current of 0 Ma .....	1000 $\mu$ a
For Load Current of 1 Ma .....	45 $\mu$ a

**Regulated DC Output Voltage**

For Load Current of 0 Ma .....	25,000 Volts
For Load Current of 1 Ma .....	24,500 Volts

Amplification Factor .....	2000
----------------------------	------

**X-RADIATION CHARACTERISTIC**

Maximum X-Radiation ..... 25.0 mR/h

X-Radiation is measured in accordance with JEDEC Publication No. 67, "Recommended Practice for Measurement of X-Radiation from Receiving Tubes," dated February 1968 and quality controlled in accordance with JEDEC Publication No. 73, "Recommended Practice for Quality Control of X-Radiation Emitted from High Voltage Rectifier and Shunt Regulator Receiving Tubes."

Lot acceptance sampling procedures for the manufacturer's initial and life tests for X-Radiation are based on MIL-STD-105, "Military Standard Sampling Procedures and Tables for Inspection by Attributes." Lot acceptance and life control limits are established substantially below the X-Radiation Characteristic Maximum.

**NOTES:**

- (1) Peak value for maximum of 20 seconds during equipment warm-up.
- (2) With flyback transformer high voltage supply.

**X-RADIATION WARNING:** The high voltages associated with this tube type result in the production of X-radiation which may constitute a health hazard on prolonged exposure at close range unless the tube is adequately shielded. Precautions must be exercised during the servicing of equipment to assure that all shielding components are replaced to their intended positions before the equipment is operated.

**SHUNT REGULATOR CIRCUIT**

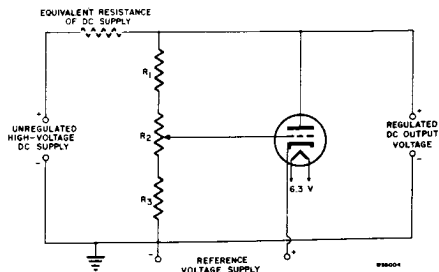

98004

**TRANSFER CHARACTERISTICS (6BK4C/6EL4A)**

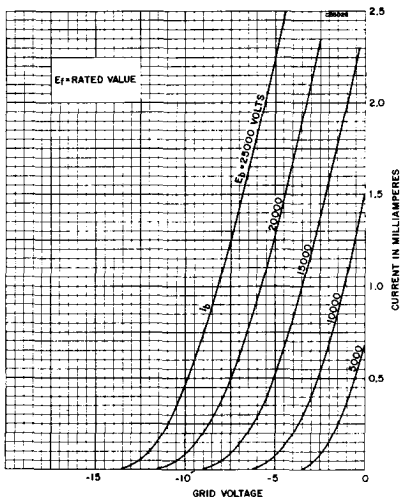

**6BK7B**  
5BK7A

Color Television Type  
**VHF CASCODE AMPLIFIER**

**Twin Medium Mu Triodes**

- Construction ..... Miniature T-6½
- Base ..... Button 9 Pin, E9-1
- Basing ..... 9AJ
- Outline ..... 6-2
  - Maximum Diameter ..... 0.875 In.
  - Maximum Seated Height ..... 1.937 In.
  - Maximum Overall Height ..... 2.187 In.

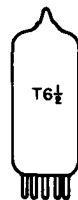
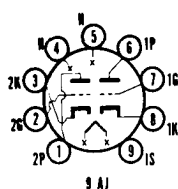

**ELECTRICAL DATA**

**HEATER OPERATION**

	<b>5BK7A</b>	<b>6BK7B</b>
Heater Voltage.....	4.7	6.3 Volts
Heater Current .....	600	450 Ma
Heater Warm-up Time .....	11	11 Seconds
Maximum Heater-Cathode Voltage		
Heater Negative with Respect to Cathode		
Total DC and Peak <sup>(1)</sup> .....		200 Volts
Heater Positive with Respect to Cathode		
DC .....		100 Volts
Total DC and Peak.....		200 Volts

**DIRECT INTERELECTRODE CAPACITANCES (Unshielded)**

	<b>Section 1<sup>(2)</sup></b>	<b>Section 2<sup>(2)</sup></b>
Grid to Plate .....	1.8	1.8 Pf
Input .....	3.0	3.0 Pf
Output .....	1.0	0.9 Pf
Heater to Cathode .....	2.8	3.0 Pf
Grid to Grid (Max.) .....	0.004	Pf
Plate to Plate (Max.).....	0.075	Pf
<b>Grounded Grid Operation</b>		
Plate to Cathode .....	0.22	0.22 Pf
Input .....	6.0	6.0 Pf
Output .....	2.4	2.4 Pf
<b>RATINGS (Design Center Rating System)</b>		
Plate Voltage (Max.) .....		300 Volts



Negative DC Grid Voltage (Max.) .....	50 Volts
Plate Dissipation (Each Section) (Max.) .....	2.7 Watts
<b>CHARACTERISTICS AND TYPICAL OPERATION</b>	
<b>Class A1 Amplifier (Each Section)</b>	
Plate Voltage .....	150 Volts
Cathode Bias Resistor .....	56 Ohms
Plate Current .....	18 Ma
Transconductance .....	9300 $\mu$ mhos
Amplification Factor .....	43
Plate Resistance.....	4600 Ohms
Grid Voltage for $I_b = 10 \mu$ a .....	-11 Volts

**NOTES:**

- (1) When operated as a cascode amplifier and the two sections are connected in series, the heater-cathode voltage of the grounded grid stage may be as high as 300 volts maximum with the heater negative with respect to the cathode.
- (2) Section 1 connects to Pins 6, 7, and 8. Section 2 connects to Pins 1, 2, and 3.

<p><i>Color Television Type</i></p> <p><b>VERTICAL DEFLECTION OSCILLATOR AND AMPLIFIER</b></p>	<p>6BL7GT</p>
--	---------------

**Twin Triode**

Construction .....	Octal T-9
Base .....	8 Pin, B8-58
Basing .....	.8BD
Outline .....	9-41
Maximum Diameter .....	1.188 In.
Maximum Seated Height .....	2.750 In.
Maximum Overall Height .....	3.313 In.

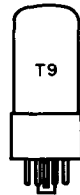
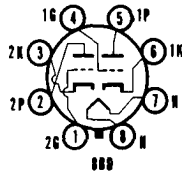

**ELECTRICAL DATA**

**HEATER OPERATION**

Heater Voltage.....	6.3 Volts
Heater Current .....	1500 Ma
Maximum Heater-Cathode Voltage	
Heater Negative with Respect to Cathode	
Total DC and Peak.....	200 Volts
Heater Positive with Respect to Cathode	
DC .....	100 Volts
Total DC and Peak.....	200 Volts

**DIRECT INTERELECTRODE CAPACITANCES (Unshielded)**

	Section No. 1	Section No. 2
Grid to Plate .....	6.0	6.0 Pf
Input .....	4.2	4.6 Pf
Output .....	0.9	0.9 Pf

**RATINGS (Design Center Rating System)**

**Vertical Deflection Oscillator and Amplifier<sup>(1,2)</sup>**

	Oscillator	Amplifier
Plate Voltage (Max.) .....	500	500 Volts
Peak Positive Pulse Plate Voltage (Abs. Max.).....	3	2000 Volts
Plate Dissipation (Each Plate) (Max.) <sup>(3)</sup> .....	10	10 Watts
Total Plate Dissipation (Both Plates) (Max.) .....	12	12 Watts
Peak Negative Pulse Grid Voltage (Max.).....	400	250 Volts
Average Cathode Current (Max.).....	60	60 Ma
Peak Cathode Current (Max.) .....	210	210 Ma
Grid Circuit Resistance (Max.).....	2.2	2.2 Megohms

**CHARACTERISTICS AND TYPICAL OPERATION (Each Section)**

Plate Voltage .....	250 Volts
Grid Voltage .....	-9 Volts
Plate Current .....	40 Ma
Transconductance .....	7000 $\mu$ mhos
Amplification Factor .....	15
Plate Resistance (Approx.) .....	2150 Ohms
Plate Current at $E_c = -17$ Volts .....	4.0 Ma
$E_{c1}$ for $I_b = 50 \mu$ a (Approx.).....	-23 Volts

**INSTANTANEOUS PLATE KNEE CHARACTERISTICS**

$E_b = 150$  V and  $E_{c1} = 0$  V  
 $I_b = 65$  Ma

**NOTES:**

- (1) For operation in a 525 line, 30 frame system as described in "Standards of Good Engineering Practice for Television Broadcast Stations; Federal Communications Commission," the duty cycle of the voltage pulse must not exceed 15% of one horizontal scanning cycle.
- (2) Section No. 1 is recommended for vertical oscillator service, and Section No. 2 is recommended for vertical deflection amplifier service.
- (3) In stages operating with grid leak bias, an adequate bias resistor or other suitable means is required to protect the tube in the absence of excitation.

**6BL8/ECF80**  
4BL8/XCF80, 6LN8

Color Television Type  
**VHF OSCILLATOR AND MIXER**

**Medium Mu Triode and Sharp Cutoff Pentode**

Construction ..... Miniature T-6½  
 Base ..... Button 9 Pin, E9-1  
 Basing ..... 9DC  
 Outline ..... 6-2  
 Maximum Diameter ..... 0.875 In.  
 Maximum Seated Height ..... 1.938 In.  
 Maximum Overall Height ..... 2.188 In.

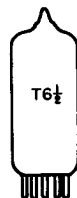
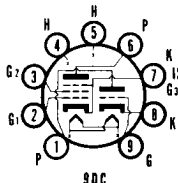

**ELECTRICAL DATA  
HEATER OPERATION**

	4BL8/XCF80	6LN8	6BL8/ECF80
Heater Voltage.....	4.6	6.0	6.3 Volts
Heater Current .....	600	450	430 Ma
Heater Warm-up Time .....	—	11	— Seconds
Maximum Heater-Cathode Voltage			
Heater Negative with Respect to Cathode			
Total DC and Peak.....			200 Volts
Heater Positive with Respect to Cathode			
DC .....			100 Volts
Total DC and Peak.....			200 Volts

**DIRECT INTERELECTRODE CAPACITANCES**

**Triode Section**

Grid to Plate .....	1.5 Pf
Input: g1 to (k + Pg3 + IS + h) .....	2.5 Pf
Output: p to (k + Pg3 + IS + h) .....	1.8 Pf

**Pentode Section**

Grid No. 1 to Plate .....	0.025 Pf
Input: g1 to (k + g3 + IS + g2 + h).....	5.2 Pf
Output: p to (k + g3 + IS + g2 + h).....	3.4 Pf

**Coupling**

Pentode Plate to Triode Plate .....	0.07 Pf
Pentode Plate to Triode Grid.....	0.02 Pf
Pentode Grid No. 1 to Triode Plate .....	0.16 Pf

**RATINGS (Design Maximum Rating System)**

**Pentode Section**

Plate Supply Voltage (Max.) .....	600 Volts
Plate Voltage (Max.) .....	275 Volts
Plate Dissipation (Max.) .....	1.9 Watts
Screen Supply Voltage (Max.) .....	600 Volts
Screen Voltage (Ik = 14 Ma) (Max.).....	175 Volts
Screen Voltage (Ik = 10 Ma) (Max.).....	200 Volts
Screen Dissipation (Max.) <sup>(1)</sup> .....	0.55 Watt
Cathode Current (Max.).....	16.5 Ma
Grid Series Resistance (Cathode Bias) (Max.).....	1 Megohm
Grid Series Resistance (Fixed Bias) (Max.).....	0.5 Megohm
Negative Grid Voltage (I <sub>g1</sub> = 0.3 μa) (Max.) <sup>(2)</sup> .....	1.3 Volts

**Triode Section**

Plate Supply Voltage (Max.) .....	600 Volts
Plate Voltage (Max.) .....	275 Volts
Plate Dissipation (Max.) .....	1.7 Watts
Cathode Current (Max.).....	16.5 Ma
Grid Series Resistance (Max.).....	0.5 Megohm
Negative Grid Voltage (I <sub>g</sub> = 0.3 μa) (Max.) <sup>(2)</sup> .....	1.3 Volts

**CHARACTERISTICS AND TYPICAL OPERATION**

**Pentode Section**

Plate Voltage .....	170 Volts
Screen Voltage .....	170 Volts
Grid Voltage .....	-2 Volts
Plate Current .....	10 Ma
Screen Current .....	2.8 Ma
Transconductance .....	6200 $\mu$ mhos
Amplification Factor .....	47
Plate Resistance .....	0.4 Megohm
Input Resistance (F = 50 MHz) .....	10,000 Ohms
Equivalent Noise Resistance .....	1500 Ohms

**Triode Section**

Plate Voltage .....	100 Volts
Grid Voltage .....	-2 Volts
Plate Current .....	14 Ma
Transconductance .....	5000 $\mu$ mhos
Amplification Factor .....	20

**Converter Service<sup>(3)</sup>**

Plate Voltage .....	170	170 Volts
Screen Voltage .....	170	170 Volts
Grid Resistance .....	0.1	0.1 Megohm
Cathode Resistor .....	330	820 Ohms
Oscillator Voltage .....	3.5	3.5 Volts
Plate Current .....	6.5	5.2 Ma
Screen Current .....	2.0	1.5 Ma
Grid Current .....	20	0 $\mu$ a
Conversion Conductance .....	2200	2100 $\mu$ mhos
Internal Resistance .....	0.8	0.87 Megohm

**NOTES:**

- (1) If the plate dissipation is less than 1.2 watts, the maximum value of the screen dissipation may be increased to 0.75 watts.
- (2) Grid voltage must not be more positive than this value.
- (3) The triode should be used in Colpitts rather than a Hartley type oscillator circuit.

*Color Television Type*

**AF AMPLIFIER or OSCILLATOR  
AUDIO POWER AMPLIFIER**

**6BM8/ECL82**

**Triode and Power Pentode**

Construction .....	Miniature T-6½
Base .....	Button 9 Pin, E9-1
Basing .....	9EX
Outline .....	6-4
Maximum Diameter .....	0.875 In.
Maximum Seated Height .....	2.813 In.
Maximum Overall Height .....	3.063 In.

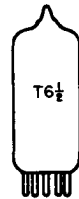
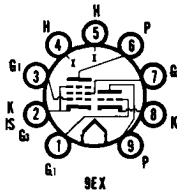

**ELECTRICAL DATA**

**HEATER OPERATION**

Heater Voltage .....	6.3 Volts
Heater Current .....	780 Ma
Maximum Heater-Cathode Voltage .....	100 Volts

**DIRECT INTERELECTRODE CAPACITANCES**

**Triode**

Grid to All Other Elements Except Plate .....	2.7 Pf
Plate to All Other Elements Except Grid .....	4.0 Pf
Plate to Grid .....	4.0 Pf
Grid to Heater (Max.) .....	0.1 Pf

**Pentode**

Grid No. 1 to All Other Elements .....	9.3 Pf
Plate to All Other Elements .....	8 Pf
Grid No. 1 to Plate (Max.) .....	0.3 Pf
Grid to 1 to Heater (Max.) .....	0.3 Pf

**Coupling**

Triode Plate to Pentode Grid No. 1 (Max.) .....	0.02 Pf
Triode Grid to Pentode Plate (Max.) .....	0.02 Pf
Triode Grid to Pentode Grid No. 1 (Max.) .....	0.025 Pf
Triode Plate to Pentode Plate (Max.) .....	0.25 Pf

**RATINGS (Design Center Rating System)**

	<b>Triode</b>	<b>Pentode</b>
Plate Supply Voltage (Max.) .....	550	900 Volts
Plate Voltage (Max.) .....	300	600 Volts
Grid No. 2 Supply Voltage (Max.) .....	—	550 Volts
Grid No. 2 Voltage (Max.) .....	—	300 Volts
Cathode Current (Max.) .....	15	50 Ma
Plate Dissipation (Max.) .....	1	7 Watts
Grid No. 2 Input (Max.) .....	—	1.8 Watts
Grid No. 1 Circuit Resistance		
Fixed Bias (Max.) .....	1	1 Megohm
Cathode Bias (Max.) .....	2	2 Megohms

**CHARACTERISTICS AND TYPICAL OPERATION**

	<b>Triode</b>	<b>Pentode</b>
Plate Voltage .....	100	200 Volts
Grid No. 2 Voltage .....	—	200 Volts
Grid No. 1 Voltage .....	0	-16 Volts
Amplification Factor .....	70	9.5 <sup>(1)</sup>
Plate Resistance .....	—	20,000 Ohms
Transconductance .....	2500	6400 $\mu$ mhos
Plate Current .....	3.5	35 Ma
Grid No. 2 Current .....	—	7 Ma

**NOTE:**

(1) Grid No. 1 to Grid No. 2.

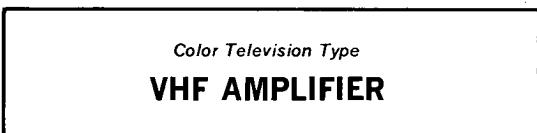
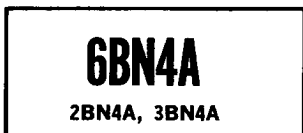

**Medium Mu Triode**

Construction ..... Miniature T-5½  
 Base ..... Button 7 Pin, E7-1  
 Basing ..... 7EG  
 Outline ..... 5-2  
 Maximum Diameter ..... 0.750 In.  
 Maximum Seated Height ..... 1.875 In.  
 Maximum Overall Height ..... 2.125 In.

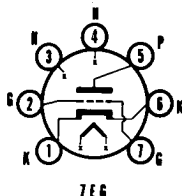

**ELECTRICAL DATA**

**HEATER OPERATION**

	<b>2BN4A</b>	<b>3BN4A</b>	<b>6BN4A</b>
Heater Voltage .....	2.35	3.0	6.3 Volts
Heater Current .....	600	450	200 Ma
Heater Warm-up Time .....	11	11	— Seconds
Maximum Heater-Cathode Voltage .....			100 Volts

**DIRECT INTERELECTRODE CAPACITANCES**

	<b>Unshielded</b>	<b>Shielded</b>
Grid to Plate .....	1.1	1.2 Pf
Input: g to (h + k) .....	2.9	3.2 Pf
Output: p to (h + k) .....	0.7	1.4 Pf

**RATINGS (Design Center Rating System)**

Plate Voltage (Max.) .....	275 Volts
Plate Dissipation (Max.) .....	2.2 Watts
Positive DC Grid Voltage (Max.) .....	0 Volt
DC Cathode Current (Max.) .....	22 Ma
Grid Circuit Resistance (Max.) .....	0.5 Megohm

**CHARACTERISTICS AND TYPICAL OPERATION**

**Class A1 Amplifier**

Plate Voltage .....	150 Volts
Cathode Bias Resistor .....	220 Ohms
Plate Current .....	9.0 Ma
Transconductance .....	7700 $\mu$ mhos
Amplification Factor .....	43
Plate Resistance (Approx.) .....	5400 Ohms
Ec for Ib = 100 $\mu$ a (Approx.) .....	-6 Volts

Color Television Type  
**GATED BEAM DISCRIMINATOR**

**6BN6/6KS6**  
3BN6, 4BN6, 12BN6

**Pentode**

Construction ..... Miniature T-5½  
 Base ..... Button 7 Pin, E7-1  
 Basing ..... 7DF  
 Outline ..... 5-3  
 Maximum Diameter ..... 0.750 In.  
 Maximum Seated Height ..... 2.375 In.  
 Maximum Overall Height ..... 2.625 In.

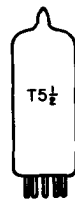
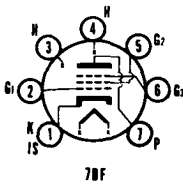

**ELECTRICAL DATA**

**HEATER OPERATION**

	3BN6	4BN6	12BN6	6BN6/6KS6
Heater Voltage.....	3.16	4.2	12.6	6.3 Volts
Heater Current .....	600	450	150	300 Ma
Heater Warm-up Time .....	11	11	—	— Seconds
Maximum Heater-Cathode Voltage				
Heater Negative with Respect to Cathode				
Total DC and Peak.....				200 Volts
Heater Positive with Respect to Cathode				
DC .....				100 Volts
Total DC and Peak.....				200 Volts

**DIRECT INTERELECTRODE CAPACITANCES (Unshielded)**

Grid No. 1 to All Other Electrodes.....	4.2 Pf
Grid No. 3 to All Other Electrodes.....	3.3 Pf
Grid No. 1 to Grid No. 3 (Max.).....	0.004 Pf

**RATINGS (Design Center Rating System)**

Plate Supply Voltage (Max.).....	300 Volts
Grid No. 2 Voltage (Accelerator) (Max.) .....	100 Volts
Peak Positive Grid No. 1 Voltage (Limiter) (Max.).....	55 Volts
Total Cathode Current (Max.).....	11.5 Ma

**CHARACTERISTICS AND TYPICAL OPERATION**

**Limiter-Discriminator Service**

Plate Supply Voltage.....	85	285	270 Volts
Plate Voltage .....	63	122	121 Volts
Grid No. 2 Voltage .....	55	100	100 Volts
Cathode Bias Resistor (Variable) <sup>(1)</sup> .....	200-400	200-400	200-400 Ohms
Plate Current .....	0.25	0.49	0.44 Ma
Grid No. 2 Current .....	4.1	9.8	10.0 Ma
Plate Load Resistor .....	85,000	330,000	330,000 Ohms
Plate Linearity Resistor.....	470	1500	1000 Ohms
Integrating Capacitor .....	0.002	0.001	0.001 µf
Coupling Capacitor .....	0.25	0.01	0.25 µf
Input Signal Center Frequency .....	10.7	10.7	4.5 Millihertz
Frequency Deviation .....	± 75	± 75	± 25 Kiloherztz
Minimum Signal Voltage for Limiting Action (RMS) <sup>(2)</sup> .....	1.25	1.25	1.25 Volts
Input Signal Level for AM Rejection Adjustment <sup>(1)</sup> .....	1.25	2.0	2.0 Volts
AM Rejection at Esig = 2.0 Volts (RMS) .....	31	20	25 Decibels
AM Rejection at Esig = 3.0 Volts (RMS) .....	30	29	30 Decibels
Total Harmonic Distortion .....	2.0	1.6	1.8 Percent
Peak Audio Output Voltage .....	6.0	16.6	16.8 Volts

**NOTES:**

- The cathode resistor should be adjusted for maximum AM rejection in the output of the limiter-discriminator stage at the specified signal level. AM rejection is measured with an applied signal containing 30% AM and 30% FM.
- At signal levels above specified value, limiting is within ± 2 decibels. Adequate shielding between components of the limiter grid and the quadrature grid must be used to insure proper phasing of the voltage developed at the quadrature grid. Standard de-emphasis requirements for FM are included. The Q of the quadrature grid circuit should be high enough to develop a minimum of 4 volts (RMS) signal with 2 volts (RMS) of the center-frequency signal applied to the limiter grid. It is recommended that the coil be shunted by a minimum of 10 Pf. The capacitance may be composed of tube input capacitance, stray capacitance, and distributed capacitance, as well as physical capacitance.

**6BN8**  
8BN8

Color Television Type  
**PHASE/RATIO DETECTOR  
OR DISCRIMINATOR  
AF/BURST AMPLIFIER OR OSCILLATOR**

**Double Diode and High Mu Triode**

Construction ..... Miniature T-6½  
Base ..... Button 9 Pin, E9-1  
Basing ..... 9ER  
Outline ..... 6-3  
Maximum Diameter ..... 0.875 In.  
Maximum Seated Height ..... 2.375 In.  
Maximum Overall Height ..... 2.625 In.

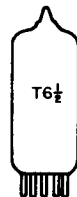
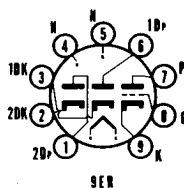

**ELECTRICAL DATA  
HEATER OPERATION**

	<b>8BN8</b>	<b>6BN8</b>
Heater Voltage.....	8.4	6.3 Volts
Heater Current.....	450	600 Ma
Heater Warm-up Time.....	11	11 Seconds
Maximum Heater-Cathode Voltage Heater Negative with Respect to Cathode Total DC and Peak.....		200 Volts
Heater Positive with Respect to Cathode DC.....		100 Volts
Total DC and Peak.....		200 Volts

**DIRECT INTERELECTRODE CAPACITANCES (Unshielded)**

**Triode**

Grid to Plate.....	2.5 Pf
Input: g to (h + Tk).....	3.6 Pf
Output: p to (h + Tk).....	0.25 Pf

**Diodes**

No. 1 Diode Plate to No. 1 Diode Cathode + Heater.....	1.9 Pf
No. 2 Diode Plate to No. 2 Diode Cathode + Heater.....	1.9 Pf
No. 1 Diode Cathode to No. 1 Diode Plate + Heater.....	4.8 Pf
No. 2 Diode Cathode to No. 2 Diode Plate + Heater.....	4.8 Pf

**Coupling**

No. 1 Diode Plate to Triode Grid (Max.).....	0.060 Pf
No. 2 Diode Plate to Triode Grid (Max.).....	0.10 Pf
No. 1 Diode Cathode to All: 1Dk to (h + Tk + 2Dk + Tp + 1Dp + Tg + 2Dp).....	5.0 Pf
No. 2 Diode Cathode to All: 2Dk to (h + Tk + 1Dk + Tp + 1Dp + 2DP + Tg).....	5.0 Pf
No. 1 Diode Plate to No. 2 Diode Plate (Max.).....	0.070 Pf
No. 1 Diode Plate to All: 1DP to (h + Tk + 1Dk + 2Dk + Tp + 2Dp + Tg).....	3.0 Pf
No. 2 Diode Plate to All: 2DP to (h + Tk + 1Dk + 2Dk + Tp + 1Dp + Tg).....	3.0 Pf

**RATINGS (Design Maximum Rating System)**

**Triode Section**

Plate Voltage (Max.).....	330 Volts
Positive DC Grid Voltage (Max.).....	0 Volt
Plate Dissipation (Max.).....	1.7 Watts
Grid Circuit Resistance (Max.).....	1.0 Megohm

**Diode Section**

Peak Plate Current (Each Plate) (Max.).....	54 Ma
DC Current (Each Plate) (Max.).....	9 Ma

**CHARACTERISTICS AND TYPICAL OPERATION**

**Triode Section, Class A1 Amplifier**

Plate Voltage.....	100	250 Volts
Grid Voltage.....	-1	-3 Volts
Plate Current.....	1.5	1.6 Ma
Transconductance.....	3500	2500 μmhos
Amplification Factor.....	75	70
Plate Resistance (Approx.).....	21,000	28,000 Ohms
Grid Voltage (Approx.) for Ib = 10 μa.....	-2.5	-5.5 Volts

**Diode Section**

Average Current Each Plate at 10 Volts DC <sup>(1)</sup> .....	50 Ma
Voltage Drop Each Section at Ib = 9 Ma DC.....	2.6 Volts

**NOTE:**

(1) Test conditions only.

Color Television Type  
**IF AMPLIFIER**

**6BN11**  
8BN11

**Double Sharp Cutoff Pentode**

Construction ..... Compactron T-9  
 Base ..... Button 12 Pin, E12-70  
 Basing ..... 12GF  
 Outline ..... 9-58  
     Maximum Diameter ..... 1.188 In.  
     Maximum Seated Height ..... 2.000 In.  
     Maximum Overall Height ..... 2.375 In.

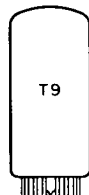
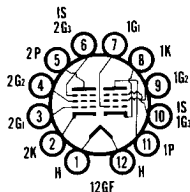

**ELECTRICAL DATA**

**HEATER OPERATION**

	<b>6BN11</b>	<b>8BN11</b>
Heater Voltage.....	8.4	6.3 Volts
Heater Current.....	600	800 Ma
Heater Warm-up Time.....	11	— Sec.
Maximum Heater-Cathode Voltage		
Heater Negative with Respect to Cathode		
Total DC and Peak.....		200 Volts
Heater Positive with Respect to Cathode		
DC.....		100 Volts
Total DC and Peak.....		200 Volts

**DIRECT INTERELECTRODE CAPACITANCES (Shielded)<sup>(1)</sup>**

**Section 1**

Grid No. 1 to Plate.....	0.04 Pf
Input: 1g1 to (1k + 1g2 + 2g3 + h + 1s).....	12 Pf
Output: 1p to (1k + 1g2 + 2g3 + h + 1s).....	2.8 Pf

**Section 2**

Grid No. 1 to Plate.....	0.03 Pf
Input: 2g1 to (2k + 2g2 + 2g3 + 1g3 + h + 1s).....	12 Pf
Output: 2p to (2k + 2g2 + 2g3 + 1g3 + h + 1s).....	2.8 Pf
Plate to Plate: (1p to 2p) (Max.).....	0.01 Pf
Grid No. 1, Section 1 to Plate, Section 2 (Max.).....	0.02 Pf
Grid No. 1, Section 2 to Plate, Section 1: (2g1 to 1p) (Max.).....	0.003 Pf
Cathode, Section 1 to Cathode, Section 2 (Max.) <sup>(2)</sup> .....	0.02 Pf

**RATINGS (Design Maximum Rating System) (Each Section)**

Plate Voltage (Max.).....	330 Volts
Screen Supply Voltage (Max.).....	330 Volts
Screen Voltage.....	See Rating Chart (Gen. Info. Sec.)
Positive DC Grid No. 1 Voltage (Max.).....	0 Volt
Plate Dissipation (Max.).....	3.1 Watts
Screen Dissipation (Max.).....	0.65 Watt
Grid No. 1 Circuit Resistance (Cathode Bias).....	0.25 Megohm

**CHARACTERISTICS AND TYPICAL OPERATION (Each Section)**

Plate Voltage.....	125 Volts
Suppressor.....	Connected to Cathode at Socket
Screen Voltage.....	125 Volts
Cathode-Bias Resistor.....	56 Ohms
Plate Resistance (Approx.).....	0.2 Megohm
Transconductance.....	13,000 $\mu$ mhos
Plate Current.....	11 Ma
Screen Current.....	3.8 Ma
Grid No. 1 Voltage (Approx.)	
I <sub>b</sub> = 20 $\mu$ a.....	-3 Volts

**NOTES:**

- (1) With external shield (EIA 309) connected to cathode of section under test.
- (2) With external shield (EIA 309) connected to ground.

# 6BQ5/EL84

8BQ5, 10BQ5

## Color Television Type AUDIO POWER AMPLIFIER

### Beam Pentode

Construction ..... Miniature T-6½  
 Base ..... Button 9 Pin, E9-1  
 Basing ..... .9CV  
 Outline ..... 6-4  
 Maximum Diameter ..... 0.875 In.  
 Maximum Seated Height ..... 2.812 In.  
 Maximum Overall Height ..... 3.062 In.

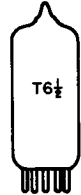
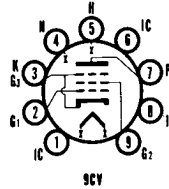

### ELECTRICAL DATA HEATER OPERATION

	10BQ5	8BQ5	6BQ5/EL84
Heater Voltage.....	10.6	8.0	6.3 Volts
Heater Current.....	450	600	760 Ma
Heater Warm-up Time.....	11	11	— Seconds
Maximum Heater Cathode Voltage.....			100 Volts

### DIRECT INTERELECTRODE CAPACITANCES

Grid No. 1 to Plate (Max.).....	0.5 Pf
Input.....	10.8 Pf
Output.....	6.5 Pf
Grid No. 1 to Heater (Max.).....	0.25 Pf

### RATINGS (Design Center Rating System)

Plate Voltage (Max.) <sup>(1)</sup> .....	300 Volts
Grid No. 2 Voltage (Max.) <sup>(1)</sup> .....	300 Volts
Negative Grid No. 1 Voltage (Max.).....	100 Volts
Plate Dissipation (Max.).....	12 Watts
Grid No. 2 Dissipation (Max.).....	2 Watts
Cathode Current (Max.).....	65 Ma
Grid No. 1 Circuit Resistance.....	
Fixed Bias (Max.).....	0.3 Megohm
Cathode Bias (Max.).....	1.0 Megohm

### CHARACTERISTICS AND TYPICAL OPERATION

	Triode Operation <sup>(2)</sup>			Pentode Operation		
	Class A1 Single Tube	Class AB1 Push-pull	Class AB1 Push-pull	Class A1 Single Tube	Class AB1 Push-pull	Class AB1 Push-pull
Plate Voltage.....	250	250	300	250	250	300 Volts
Grid No. 2 Voltage.....	—	—	—	250	250	300 Volts
Grid No. 1 Voltage.....	—	—	—	-7.3	—	— Volts
Cathode Resistor <sup>(3)</sup> .....	270	270	270	135	130	130 Ohms
Grid Voltage (RMS) <sup>(4)</sup> .....	6.7	8.4	10	4.3	8	10 Volts
Plate Current						
(Zero-Signal).....	34	40	48	48	62	72 Ma
(Maximum Signal).....	36	53.4	52	49.5	75	92 Ma
Grid No. 2 Current						
(Zero Signal).....	—	—	—	5.5	7.0	8 Ma
(Maximum Signal).....	—	—	—	10.8	15	22 Ma
Transconductance.....	—	—	—	11.3K	—	— μmhos
Amplification Factor <sup>(1)</sup> .....	—	—	—	19	—	—
Plate Resistance.....	—	—	—	38K	—	— Ohms
Load Resistance.....	3.5K	—	—	5.2K	—	— Ohms
Load Resistance (Plate to Plate).....	—	10K	10K	—	8K	8K Ohms
Maximum-Signal Power Output... Total Harmonic Distortion <sup>(1)</sup> .....	1.95 9	3.4 2.5	5.2 2.5	5.7 10	11 3.0	17 4.0 Watts Percent
<b>CLASS AB1 ULTRA-LINEAR CONNECTION<sup>(4)</sup></b>						
Plate Voltage.....						300 Volts
Cathode Resistor (Per Tube).....						270 Ohms
Grid Voltage (RMS).....						8 Volts
Cathode Current (Zero Signal).....						80 Ma
Cathode Current (Max. Signal).....						90 Ma
Load Resistance (P1 to P1).....						8000 Ohms
Power Output.....						11 Watts

### NOTES:

- (1) When the heater and positive voltages are obtained from a storage battery by means of a vibrator, the maximum values of the plate and Grid No. 2 voltage is 250 volts and the plate dissipation is 9 watts.



- (2) Grid No. 2 connected to plate.
- (3) Common cathode resistor for push-pull applications.
- (4) Per grid.
- (5) Measured from grid No. 2 to plate.
- (6) For Pentode Operation—Class A Amplifier Service, the maximum signal power output and total distortion are measured at fixed bias and therefore represses the power output available during the reproduction of speech and music. When a sustained sine wave is applied to the control grid the bias across the cathode resistor will readjust itself as a result of the increased plate and screen grid currents. This will result in approximately 10 percent reduction in power output.
- (7) Measured with fixed bias.
- (8) Grid No. 2 taps located at 43% of primary winding.

*Color Television Type*

## HORIZONTAL DEFLECTION AMPLIFIER

## 6BQ6GTB/6CU6

12BQ6GTB/12CU6  
17BQ6GTB  
25BQ6GTB/25CU6

**Beam Power Pentode**

Construction ..... Octal T-9  
 Base<sup>(1)</sup>.. B5-187, B6-81, B6-84, B7-7, or B7-59  
 Top Cap..... C1-2, C1-3, or C1-33  
 Basing ..... 6AM  
 Outline ..... 9-49 or 9-50  
 Maximum Diameter ..... 1.188 In.  
 Maximum Seated Height ..... 3.313 In.  
 Maximum Overall Height ..... 3.875 In.

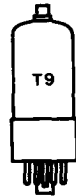
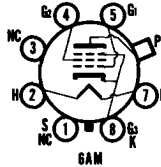

**ELECTRICAL DATA  
HEATER OPERATION**

	25BQ6GTB/ 25CU6	17BQ6GTB	12BQ6GTB/ 12CU6	6BQ6GTB/ 6CU6
Heater Voltage.....	25	16.8	12.6	6.3 Volts
Heater Current .....	300	450	600	1200 Ma
Heater Warm-up Time .....	—	11	11	— Seconds
Maximum Heater-Cathode Voltage				
Heater Negative with Respect to Cathode				
Total DC and Peak.....				200 Volts
Heater Positive with Respect to Cathode				
DC .....				100 Volts
Total DC and Peak.....				200 Volts

**DIRECT INTERELECTRODE CAPACITANCES (Unshielded)**

Grid No. 1 to Plate .....	0.6 Pf
Input .....	15 Pf
Output .....	7.5 Pf

**RATINGS (Design Center Rating System)**

DC Plate Supply Voltage (Boost + DC Power Supply) (Max.) .....	600 Volts
Peak Positive Plate Voltage (Abs. Max.) .....	6000 Volts
Peak Negative Plate Voltage (Max.) .....	1250 Volts
Plate Dissipation (Max.) <sup>(2)</sup> .....	11 Watts
Peak Negative Grid No. 1 Voltage (Max.) .....	300 Volts
Grid No. 2 Voltage (Max.) .....	200 Volts
Grid No. 2 Dissipation (Max.) .....	2.5 Watts
Average Cathode Current (Max.) .....	110 Ma
Peak Cathode Current (Max.) .....	400 Ma
Grid No. 1 Circuit Resistance (Max.) .....	0.47 Megohm
Bulb Temperature (At Hottest Point) (Max.) .....	220 °C

**CHARACTERISTICS AND TYPICAL OPERATION**

Plate Voltage .....	250 Volts
Grid No. 2 Voltage .....	150 Volts
Grid No. 1 Voltage .....	-22.5 Volts
Plate Current .....	57 Ma
Grid No. 2 Current .....	2.1 Ma
Transconductance .....	5900 μmhos
Plate Resistance.....	14,500 Ohms
Amplification Factor (Eb and Ec2 = 150 V, Ec1 = -22.5 V) .....	4.3
Ec1 for Ib = 1.0 Ma (Approx.) .....	-43 Volts

**INSTANTANEOUS PLATE KNEE VALUES**

Eb = 60 V; Ec2 = 150 V and Ec1 = 0  
 Ib = 260 Ma, and Ic2 = 26 Ma

**NOTES:**

- (1) Pin No. 1 omitted on Base No. B6-81 and B6-84.
- (2) For operation in a 525 line, 30 frame system as described in "Standards of Good Engineering Practice for Television Broadcast Stations; Federal Communications Commission," the duty cycle of the voltage pulse must not exceed 15% of one horizontal scanning cycle.
- (3) In stages operating with grid leak bias, an adequate cathode bias resistor or other suitable means is required to protect the tube in the absence of excitation.

**AVERAGE PLATE CHARACTERISTICS**

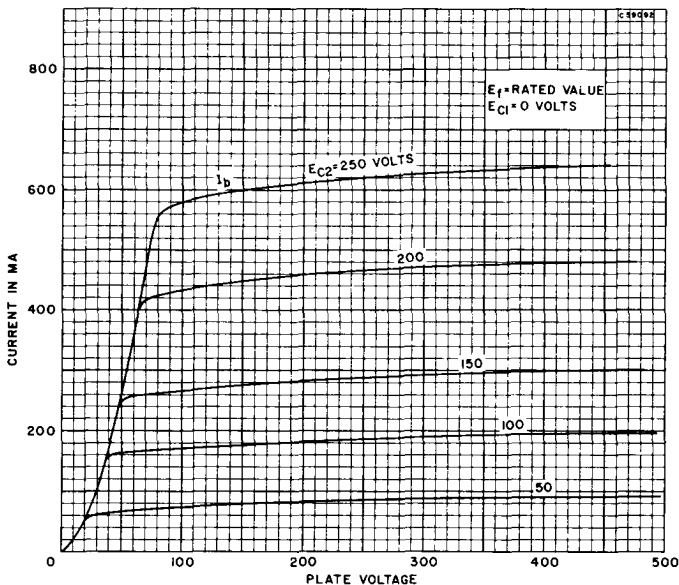

**6BQ7A/6BZ7**  
4BQ7A/4BZ7, 5BQ7A, 5BZ7

Color Television Type  
**VHF CASCODE AMPLIFIER**

**Twin Medium Mu Triode**

Construction ..... Miniature T-6½  
Base ..... Button 9 Pin, E9-1  
Basing ..... 9AJ  
Outline ..... .6-2  
Maximum Diameter ..... 0.875 In.  
Maximum Seated Height ..... 1.938 In.  
Maximum Overall Height ..... 2.188 In.

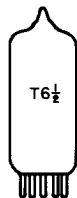
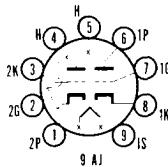

**ELECTRICAL DATA**

**HEATER OPERATION**

	<b>4BQ7A/ 4BZ7</b>	<b>5BQ7A 5BZ7</b>	<b>6BQ7A/ 6BZ7</b>
Heater Voltage.....	4.2	5.6	6.3 Volts
Heater Current.....	600	450	400 Ma
Heater Warm-up Time.....	11	11	— Seconds
Maximum Heater-Cathode Voltage			
Heater Negative with Respect to Cathode			
Total DC and Peak <sup>(1)</sup> .....			200 Volts
Heater Positive with Respect to Cathode			
DC.....			100 Volts
Total DC and Peak.....			200 Volts

**DIRECT INTERELECTRODE CAPACITANCES (Shielded)<sup>(2)</sup>**

	Section 1 <sup>(3)</sup>	Section 2 <sup>(3)</sup>
Grid to Plate .....	1.2	1.2 Pf
Input: g to (h + k + IS) .....	2.6	5.0 <sup>(4)</sup> Pf
Output: p to (h + k + IS) .....	1.2	2.2 <sup>(4)</sup> Pf
Plate to Cathode (Max.) .....	0.12	0.12 Pf
Heater to Cathode .....	2.6	2.5 Pf
Plate Section 1 to Plate Section 2 (Max.) .....	0.010	Pf
Plate Section 2 to Plate and Grid Section 1 (Max.) ..	0.024	Pf

**RATINGS (Design Maximum Rating System) (Each Section)**

Plate Voltage (Max.) <sup>(1)</sup> .....	250 Volts
Plate Dissipation (Max.) .....	2 Watts
Cathode Current (Max.) .....	20 Ma
Grid Circuit Resistance (Max.) .....	0.5 Megohm

**CHARACTERISTICS AND TYPICAL OPERATION**

**Class A1 Amplifier (Each Section)**

Plate Voltage .....	150 Volts
Cathode Bias Resistor .....	220 Ohms
Plate Current .....	9 Ma
Transconductance .....	6400 $\mu$ mhos
Plate Resistance .....	5900 Ohms
Amplification Factor .....	38
Grid Voltage for $I_b = 100 \mu$ a (Approx.) .....	-6.5 Volts

**NOTES:**

- (1) Under cutoff conditions, in rf grounded grid circuits with direct coupled drive, this voltage may be as high as 300 volts.
- (2) EIA shield No. 315 connected to Pin No. 9.
- (3) Section No. 1 connects to Pins 6, 7, and 8. Section No. 2 connects to Pins 1, 2, and 3.
- (4) Read as grounded grid amplifier.

**AVERAGE TRANSFER CHARACTERISTICS**

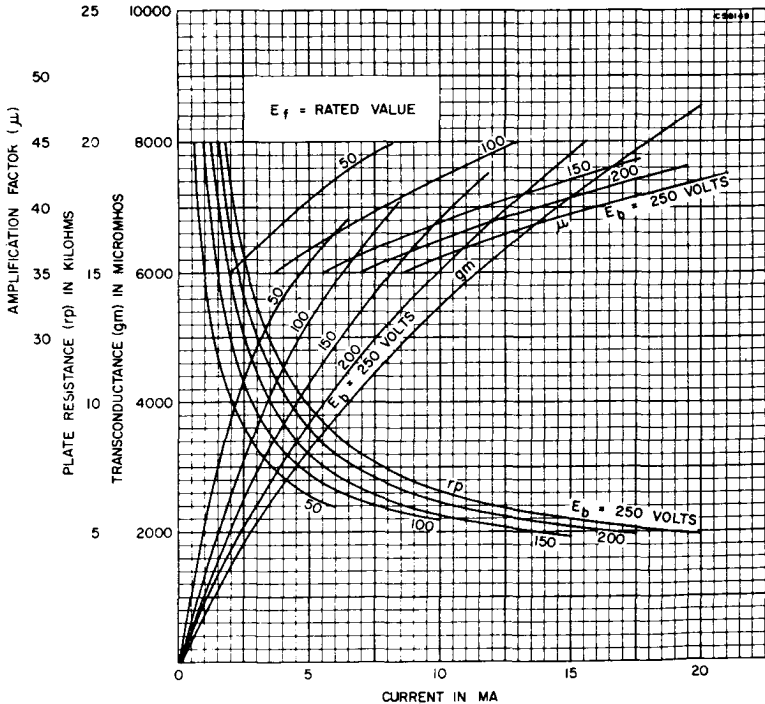

**AVERAGE PLATE CHARACTERISTICS**

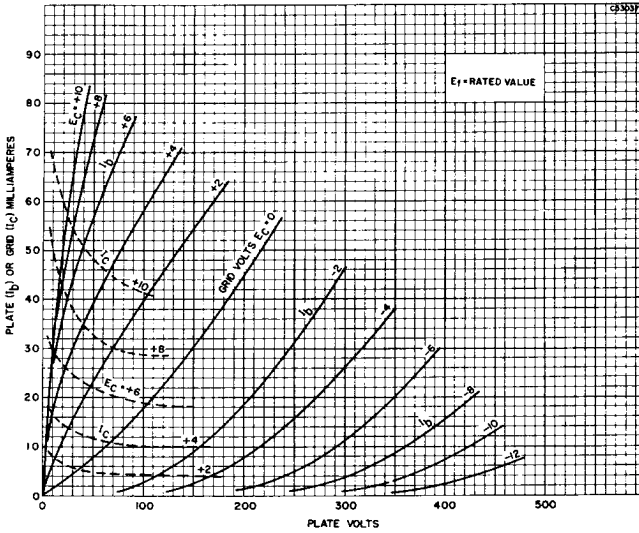

**6BR8A**  
5BR8

Color Television Type  
**VHF OSCILLATOR AND MIXER**

**Medium Mu Triode and Sharp Cutoff Pentode**

- Construction ..... Miniature T-6½
- Base ..... Button 9 Pin, E9-1
- Basing ..... 9FA
- Outline ..... 6-2
- Maximum Diameter ..... 0.875 In.
- Maximum Seated Height ..... 1.938 In.
- Maximum Overall Height ..... 2.188 In.

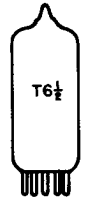
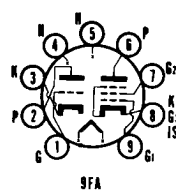

**ELECTRICAL DATA  
HEATER OPERATION**

	<b>5BR8</b>	<b>6BR8A</b>
Heater Voltage.....	4.7	6.3 Volts
Heater Current.....	600	450 Ma
Heater Warm-up Time .....	11	11 Seconds
Maximum Heater-Cathode Voltage		
Heater Negative with Respect to Cathode		250 Volts
Total DC and Peak.....		
Heater Positive with Respect to Cathode		
DC .....		100 Volts
Total DC and Peak.....		200 Volts

**DIRECT INTERELECTRODE CAPACITANCES**

	<b>Shielded (1)</b>	<b>Unshielded</b>
<b>Triode Section</b>		
Grid to Plate .....	1.8	1.8 Pf
Triode Input .....	2.8	2.8 Pf
Triode Output.....	2.0	1.5 Pf
Heater to Cathode .....	2.4	2.4 Pf
<b>Pentode Section</b>		
Grid No. 1 to Plate (Max.).....	0.010	0.020 Pf
Input .....	4.6	4.6 Pf
Output .....	3.2	2.4 Pf
Heater to Cathode .....	2.4	2.4 Pf

**RATINGS (Design Maximum Rating System)**

	<b>Triode Section</b>	<b>Pentode Section</b>
Plate Voltage (Max.) .....	330	330 Volts
Grid No. 2 Voltage .....	See Rating Chart (Gen. Info. Sec.)	
Grid No. 2 Supply Voltage (Max.) .....	330	330 Volts
Positive Grid Voltage (Max.) .....	0	0 Volt
Plate Dissipation (Max.) .....	2.5	3.0 Volts
Grid No. 2 Dissipation (Max.) .....	—	0.55 Watt

**CHARACTERISTICS AND TYPICAL OPERATION**

	<b>Triode Section</b>	<b>Pentode Section</b>
<b>Class A1 Amplifier</b>		
Plate Voltage .....	125	125 Volts
Grid No. 2 Voltage .....	—	110 Volts
Grid No. 1 Voltage .....	-1.0	-1.0 Volts
Plate Current .....	13.5	9.5 Ma
Grid No. 2 Current .....	—	3.5 Ma
Transconductance .....	7500	5000 $\mu$ mhos
Amplification Factor .....	40	—
Plate Resistance (Approx.) .....	—	200,000 Ohms
Zero Bias Transconductance (with $E_b = 100$ V, $E_{c2} = 70$ V) .....	—	6000 $\mu$ mhos

**NOTE:**

(1) With external EIA No. 315 shield connected to cathode of section under test.

Color Television Type

## DAMPER

# 6BS3

12BS3, 17BS3

**Heater-Cathode Diode**

Construction ..... Novar T-9  
 Base ..... Button 9 Pin, E9-75  
 Basing<sup>(1)</sup> ..... 9HP  
 Outline ..... 9-86  
 Maximum Diameter ..... 1.188 In.  
 Maximum Seated Height ..... 3.030 In.  
 Maximum Overall Height ..... 3.410 In.

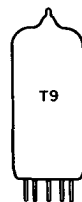
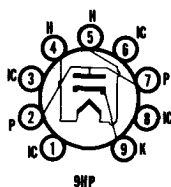

**ELECTRICAL DATA**

**HEATER OPERATION**

	17BS3	12BS3	6BS3
Heater Voltage.....	16.8	12.6	6.3 Volts
Heater Current .....	450	600	1200 Ma
Heater Warm-up Time .....	11	11	— Seconds
Maximum Heater-Cathode Voltage			
Heater Negative with Respect to Cathode			
DC .....			900 Volts
Total DC and Peak .....			5000 Volts
Heater Positive with Respect to Cathode			
DC .....			100 Volts
Total DC and Peak.....			300 Volts

**DIRECT INTERELECTRODE CAPACITANCES (Unshielded)**

Heater to Cathode .....	2.8 Pf
Plate to Cathode and Heater.....	6.5 Pf
Cathode to Plate and Heater.....	9.0 Pf

**RATINGS (Design Maximum Rating System)**

**Damper Service**

Peak Inverse Plate Voltage (Max.) <sup>(2)</sup> .....	5000 Volts
Plate Dissipation (Max.) .....	6.0 Watts
Steady State Peak Current (Max.) .....	1100 Ma
DC Plate Current (Max.) .....	200 Ma

**CHARACTERISTICS AND TYPICAL OPERATION**

Tube Voltage Drop for $I_b = 140$ Ma .....	12 Volts
--	----------

**NOTES:**

- (1) Pins 1, 3, 6, and 8 should not be used as tie points.
- (2) For operation in a 525 line, 30 frame system as described in "Standards of Good Engineering Practice for Television Broadcast Stations; Federal Communications Commission," the duty cycle of the voltage pulse must not exceed 15% of one horizontal scanning cycle.

**6BS3A**  
12BS3A, 17BS3A

Color Television Type  
**DAMPER**

**Heater-Cathode Diode**

Construction .....Novar T-9  
Base .....Button 9 Pin, E9-89  
Basing .....9HP  
Outline

Maximum Diameter .....1.188 In.  
Maximum Seated Height .....2.625 In.  
Maximum Overall Height .....3.005 In.

The 6BS3A, 12BS3A, and 17BS3A are identical to the 6BS3, 12BS3, and 17BS3 except for base with exhaust tip at bottom and shorter bulb.

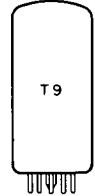
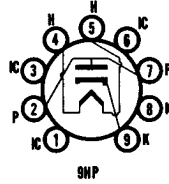

**6BS8**  
5BS8, 4BS8

Color Television Type  
**VHF CASCADE AMPLIFIER**

**Medium Mu Twin Triode**

Construction .....Miniature T-6½  
Base .....Button 9 Pin, E9-1  
Basing .....9AJ  
Outline .....6-2

Maximum Diameter .....0.875 In.  
Maximum Seated Height .....1.938 In.  
Maximum Overall Height .....2.188 In.

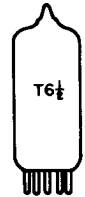
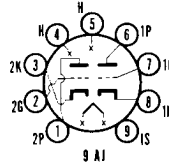

**ELECTRICAL DATA**

**HEATER OPERATION**

	4BS8	5BS8	6BS8
Heater Voltage.....	4.5	5.6	6.3 Volts
Heater Current.....	600	450	400 Ma
Heater Warm-up Time.....	11	11	— Seconds
Maximum Heater-Cathode Voltage			
Heater Negative with Respect to Cathode			
Total DC and Peak.....			200 Volts
Heater Positive with Respect to Cathode			
DC.....			100 Volts
Total DC and Peak.....			200 Volts

**DIRECT INTERELECTRODE CAPACITANCES (Shielded)<sup>(1)</sup>**

	Section 1	Section 2
Grid to Plate.....	1.15	1.15 Pf
Input.....	2.6	— Pf
Output.....	1.2	— Pf
Heater to Cathode.....	2.6	2.6 Pf
Plate to Cathode (Max.).....	0.15	0.15 Pf

**Coupling**

Plate to Plate (Max.).....	0.01	Pf
Plate of Section 2 to Plate and Grid of Section 1 (Max.).....	0.024	Pf

**Grounded Grid Operation**

Input.....	5.0	5.0 Pf
Output.....	2.2	2.2 Pf

**RATINGS (Design Center Rating System)**

Plate Voltage (Max.).....	150 Volts
Plate Dissipation (Each Section) (Max.).....	2.0 Watts
DC Cathode Current (Max.).....	20 Ma
Grid Circuit Resistance (Each Section) (Max.).....	0.5 Megohm

**CHARACTERISTICS AND TYPICAL OPERATION**

**Class A1 Amplifier (Each Section)**

Plate Voltage .....	150 Volts
Cathode Bias Resistor .....	220 Ohms
Plate Current .....	10 Ma
Transconductance .....	7200 $\mu$ mhos
Amplification Factor .....	36
Plate Resistance.....	5000 Ohms
Grid Voltage for $I_b = 10 \mu a$ (Section 2 only) .....	-7 Volts

**Cascode Amplifier**

Plate Supply Voltage.....	250 Volts
Plate Current .....	16 Ma
Grid Voltage .....	-1 Volt
Transconductance .....	10,000 $\mu$ mhos
Ec1 for $g_m = 50 \mu$ mhos (Approx.) .....	-6 Volts

**NOTES:**

- (1) External shield No. 315.
- (2) Section 2 (Pins 1, 2, and 3) is intended as the input section of the cascode circuit.

*Color Television Type*

**AFC or DETECTOR (D)  
IF/VIDEO/AGC AMPLIFIER (P)**

**6BT8**

5BT8

**Double Diode and Sharp Cutoff Pentode**

Construction .....	Miniature T-6 $\frac{1}{2}$
Base .....	Button 9 Pin, E9-1
Basing .....	9FE
Outline .....	6-2
Maximum Diameter .....	0.875 In.
Maximum Seated Height .....	1.938 In.
Maximum Overall Height .....	2.188 In.

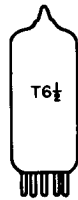
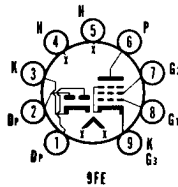

**ELECTRICAL DATA  
HEATER OPERATION**

Heater Voltage.....	<b>5BT8</b> 4.7	<b>6BT8</b> 6.3 Volts
Heater Current .....	600	450 Ma
Heater Warm-up Time .....	11	— Seconds
Maximum Heater-Cathode Voltage		
Heater Negative with Respect to Cathode		
Total DC and Peak.....		200 Volts
Heater Positive with Respect to Cathode		
DC .....		100 Volts
Total DC and Peak.....		200 Volts

**DIRECT INTERELECTRODE CAPACITANCES (Unshielded)**

<b>Pentode Section</b>	
Grid No. 1 to Plate (Max.).....	0.04 Pf
Input .....	7.0 Pf
Output .....	2.3 Pf

**Diode (Each Section)**

Plate to (h + k) .....	1.3 Pf
Cathode to (h + p) .....	3.0 Pf

**Coupling**

Pentode Grid No. 1 to Diode Plate .....	0.005 Pf
Pentode Plate to Diode Plate .....	0.020 Pf

**RATINGS (Design Center Rating System)**

Plate Voltage (Max.) .....	300 Volts
Grid No. 2 Supply Voltage (Max.) .....	300 Volts
Grid No. 2 Voltage .....	See Rating Chart (Gen. Info. Sec.)
Positive Grid No. 1 Voltage (Max.) .....	0 Volt
Plate Dissipation (Max.) .....	2.0 Watts
Grid No. 2 Input (Max.) .....	0.5 Watt
Grid No. 1 Circuit Resistance	
Fixed Bias (Max.).....	0.25 Megohm
Self Bias (Max.) .....	1.0 Megohm

**CHARACTERISTICS AND TYPICAL OPERATION**

<b>Pentode</b>	
Plate Voltage .....	200 Volts

Grid No. 2 Voltage .....	150 Volts
Cathode Bias Resistor .....	180 Ohms
Plate Current .....	9.5 Ma
Grid No. 2 Current .....	2.8 Ma
Transconductance .....	6200 $\mu$ mhos
Plate Resistance (Approx.) .....	300,000 Ohms
Grid No. 1 Voltage for $I_b = 10 \mu$ a (Approx.) .....	-8 Volts
<b>Diode</b>	
Average Diode Current with 10 Volts DC Applied (Each Section) .....	8.0 Ma

**6BV11**  
12BV11

Color Television Type  
**COLOR DEMODULATOR**

**Twin Dual Control Sharp Cutoff Pentode**

Construction.....Compactron T-9  
 Base .....Button 12 Pin, E12-70  
 Basing .....12HB  
 Outline .....9-59  
 Maximum Diameter .....1.188 In.  
 Maximum Seated Height .....2.250 In.  
 Maximum Overall Height .....2.625 In.

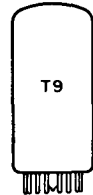
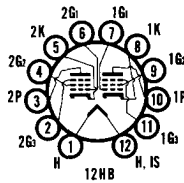

**ELECTRICAL DATA**

**HEATER OPERATION**

	<b>12BV11</b>	<b>6BV11</b>
Heater Voltage.....	12.6	6.3 Volts
Heater Current .....	450	900 Ma
Heater Warm-up Time .....	11	— Seconds

NOTE: To obtain the unique characteristics of this tube, an internal shield is tied to the heater Pin No. 12. To assure proper operation Pin No. 12 must be tied directly to ground.

**DIRECT INTERELECTRODE CAPACITANCES (Unshielded) (Each Section)**

Grid No. 1 to Plate .....	0.10 Pf
Grid No. 3 to Plate .....	3.2 Pf
Input: $g_1$ to $(h + k + g_2 + g_3 + IS)$ .....	7.0 Pf
Grid No. 3 to All.....	8.5 Pf
Grid No. 1 to Grid No. 3 .....	0.08 Pf

**RATINGS (Design Maximum Rating System) (Each Section)**

DC Plate Voltage (Max.) .....	300 Volts
Positive Grid No. 3 Voltage (DC and Peak) (Max.) .....	25 Volts
Negative Grid No. 3 Voltage (DC and Peak) (Max.).....	100 Volts
DC Grid No. 2 Supply Voltage (Max.).....	300 Volts
DC Grid No. 2 Voltage (Max.) .....	See Rating Chart (Gen. Info. Sec.)
Positive Grid No. 1 Voltage (Max.) .....	0 Volt
Negative Grid No. 1 Voltage (Max.) .....	50 Volts
Plate Dissipation (Max.) .....	1.7 Watts
Grid No. 3 Input (Max.) .....	0.1 Watt
Grid No. 2 Input (Ec2 up to 150 V) (Max.) .....	1.0 Watt
Grid No. 2 Input (Ec2 Between 150 V to 300 V) .....	See Rating Chart (Gen. Info. Sec.)
Grid No. 3 Circuit Resistance (Max.) .....	0.68 Megohm
Grid No. 1 Circuit Resistance	
Fixed Bias (Max.) .....	0.22 Megohm
Self Bias (Max.) .....	0.47 Megohm

**CHARACTERISTICS AND TYPICAL OPERATION (Each Section)**

Plate Supply Voltage.....	150 Volts
Grid No. 3 Voltage .....	0 Volt
Grid No. 2 Supply Voltage.....	100 Volts
Cathode Resistor .....	180 Ohms
Plate Current .....	3.1 Ma
Grid No. 2 Current .....	2.4 Ma
Grid No. 1 Transconductance .....	3200 $\mu$ mhos
Grid No. 3 Transconductance .....	390 $\mu$ mhos
Plate Resistance (Approx.) .....	0.17 Megohm
Ec1 for $I_b = 75 \mu$ a (Approx.).....	-3.5 Volts
Ec3 for $I_b = 85 \mu$ a (Approx.).....	-5.5 Volts
Amplification Factor (g3-P) .....	67



**AVERAGE PLATE CHARACTERISTICS  
(Each Section)**

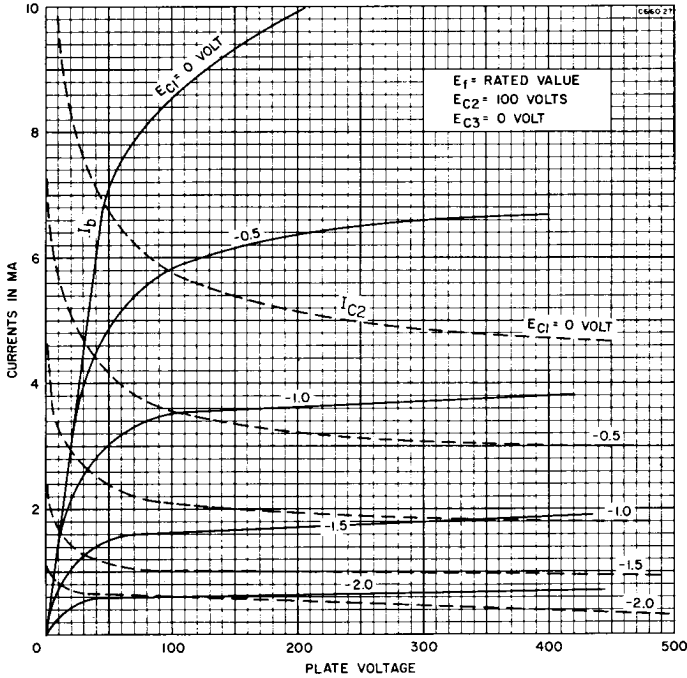

*Color Television Type*  
**GENERAL PURPOSE AMPLIFIER  
VIDEO AMPLIFIER**

**6BW11**

**Double Dissimilar Pentode**

- Construction.....Compactron T-9
- Base .....E12-70
- Basing .....12HD
- Outline .....9-58
- Maximum Diameter .....1.188 In.
- Maximum Seated Height .....2.000 In.
- Maximum Overall Height .....2.375 In.

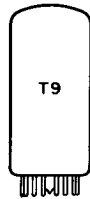
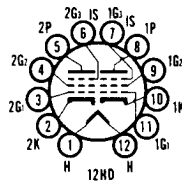

**ELECTRICAL DATA**

**HEATER OPERATION**

- Heater Voltage..... 6.3 Volts
- Heater Current ..... 800 Ma
- Maximum Heater-Cathode Voltage
- Heater Negative with Respect to Cathode
- Total DC and Peak..... 200 Volts
- Heater Positive with Respect to Cathode
- DC ..... 100 Volts
- Total DC and Peak..... 200 Volts

**DIRECT INTERELECTRODE CAPACITANCES<sup>(1)</sup>**

- Section No. 1**
- Grid to Plate ..... 0.03 pf
  - Input: g to (h + 1K + 1g2 + 1g3 + 1S)..... 7.5 pf
  - Output: p to (h + 1K + 1g2 + 1g3 + 1S)..... 2.8 pf
- Section No. 2**
- Grid to Plate (Max.)..... 0.03 pf
  - Input: g to (h + 1K + 1g2 + 1g2 + 1S)..... 12.0 pf
  - Output: p to (h + 1K + 1g2 + 1g3 + 1S)..... 2.8 pf

**Coupling**

Cathode Section 1, to Cathode Section 2: (1K to 2K), Maximum <sup>(2)</sup> .....	0.003 pf
Grid No. 1 Section 1, to Plate Section 2: (1g1 to 2p) Maximum .....	0.004 pf
Grid No. 1 Section 2, to Plate Section 1: (2g1 to 1p), Maximum .....	0.003 pf
Plate Section 1, to Plate Section 2: (1p to 2p), Maximum .....	0.018 pf

**RATINGS (Design Maximum Rating System)**

**Section No. 1**

Plate Voltage .....	330 Volts
Screen Supply Voltage .....	330 Volts
Plate Dissipation .....	4.0 Watts
Screen Dissipation .....	0.8 Watts
Grid No. 1 Circuit Resistance with Cathode Bias .....	0.25 Megohms

**Section No. 2**

Plate Voltage .....	330 Volts
Screen Supply Voltage .....	330 Volts
Positive DC Grid Voltage .....	0 Volt
Plate Dissipation .....	3.1 Watts
Screen Dissipation .....	0.65 Watts

**AVERAGE CHARACTERISTICS**

**Section No. 1**

Plate Voltage .....	125 Volts
Screen Voltage .....	125 Volts
Cathode Resistor .....	56 Ohms
Plate Resistance (Approx.) .....	120,000 Ohms
Transconductance .....	8500 $\mu$ mhos
Plate Current .....	22 Ma
Screen Current .....	4.8 Ma
E <sub>c1</sub> for I <sub>b</sub> = 20 $\mu$ a .....	9.5 Volts

**Section No. 2**

Plate Voltage .....	125 Volts
Screen Voltage .....	125 Volts
Cathode Resistor .....	56 Ohms
Plate Resistance (Approx.) .....	200,000 Ohms
Transconductance (G <sub>1</sub> ) .....	13,000 $\mu$ mhos
Plate Current .....	11 Ma
Screen Current .....	3.8 Ma
E <sub>c1</sub> for I <sub>b</sub> = 20 $\mu$ a .....	-3 Volts

**NOTES:**

- (1) With external shield No. 309 connected to cathode of section under test unless otherwise indicated.
- (2) With external shield No. 309 connected to ground.

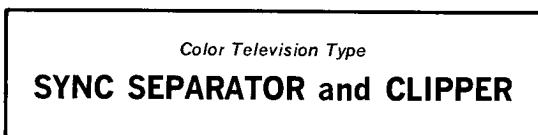

**Heptode**

Construction .....	Miniature T-5½
Base .....	Button 7 Pin, E7-1
Basing .....	.7CH
Outline .....	5-2
Maximum Diameter .....	0.750 In.
Maximum Seated Height .....	1.875 In.
Maximum Overall Height .....	2.125 In.

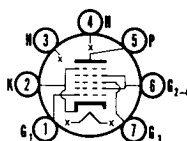

7 CH

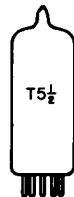

**ELECTRICAL DATA**

**HEATER OPERATION**

Heater Voltage .....	<b>3BY6</b> 3.15	<b>6BY6</b> 6.3 Volts
Heater Current .....	600	300 Ma
Heater Warm-up Time .....	11	— Seconds
Maximum Heater-Cathode Voltage Heater Negative with Respect to Cathode Total DC and Peak .....		200 Volts

Heater Positive with Respect to Cathode

DC .....	100 Volts
Total DC and Peak.....	200 Volts

**DIRECT INTERELECTRODE CAPACITANCES**

Grid No. 1 to Plate (Max.).....	0.08 Pf
Grid No. 3 to Plate (Max.).....	0.35 Pf
Grid No. 1 to Grid No. 3 (Max.).....	0.22 Pf
Grid No. 1 to All Other Electrodes.....	5.4 Pf
Grid No. 3 to All Other Electrodes.....	6.9 Pf
Plate to All Other Electrodes.....	7.6 Pf

**RATINGS (Design Maximum Rating System)**

Plate Voltage (Max.) .....	330 Volts
Grid No. 2 and Grid No. 4 Voltage .....	See Rating Chart (Gen. Info. Sec.)
Grid No. 2 and Grid No. 4 Supply Voltage (Max.).....	330 Volts
Grid No. 3 Voltage	
Negative Bias Value (Max.) .....	-55 Volts
Positive Bias Value (Max.) .....	0 Volt
Positive Peak Value (Max.) .....	27 Volts
Grid No. 1 Voltage (Negative Bias Value) (Max.) .....	-100 Volts
Plate Dissipation (Max.) .....	2.3 Watts
Grid No. 3 Input (Max.) .....	0.1 Watt
Grid No. 1 and Grid No. 4 Input	
Up to 165 Volts (Max.).....	1.1 Watts
165 to 330 Volts .....	See Rating Chart (Gen. Info. Sec.)
Grid No. 1 Input (Max.) .....	0.1 Watt
Grid No. 1 or Grid No. 3 Circuit Resistance	
Fixed Bias .....	0.5 Megohm
Cathode Bias .....	1.0 Megohm

**CHARACTERISTICS AND TYPICAL OPERATION**

**Sync Separator and Clipper**

Plate Voltage .....	10 Volts
Grid No. 3 Voltage .....	0 Volt
Grid No. 2 and Grid No. 4 Voltage .....	25 Volts
Grid No. 1 Voltage .....	0 Volt
Plate Current .....	1.4 Ma
Grid No. 2 and Grid No. 4 Current.....	3.5 Ma
Eg3 for Eb = Eg2 = Eg4 = 25 V, Eg1 = 0 V and Ib = 50 $\mu$ a.....	-2.5 Volts
Eg1 for Eb = Eg2 = Eg4 = 25 V, Eg3 = 0 V and Ib = 50 $\mu$ a.....	-2.3 Volts

**LIMITER or DETECTOR (D)  
RF or IF AMPLIFIER (P)**

**6BY8**

**High Perveance Diode  
and Sharp Cutoff Pentode**

Construction .....	Miniature T-6½
Base .....	Button 9 Pin, E9-1
Basing .....	9FN
Outline .....	6-3
Maximum Diameter .....	0.875 In.
Maximum Seated Height .....	2.375 In.
Maximum Overall Height .....	2.625 In.

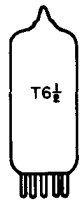
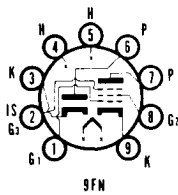

**ELECTRICAL DATA**

**HEATER OPERATION**

Heater Voltage.....	6.3 Volts
Heater Current .....	600 Ma
Heater Warm-up Time .....	11 Seconds
Maximum Heater-Cathode Voltage	
Heater Negative with Respect to Cathode	
Total DC and Peak.....	200 Volts

## Heater Positive with Respect to Cathode

DC .....	100 Volts
Total DC and Peak.....	200 Volts

**DIRECT INTERELECTRODE CAPACITANCES (Shielded)<sup>(1)</sup>**

Grid to Plate (Max.).....	0.0035 Pf
Input: g1 to (h + k + g2 + g3 + IS).....	5.5 Pf
Output: p to (h + k + g2 + g3 + IS).....	5.0 Pf
Diode Plate to All: Dp to (h + Dk + k + g1 + g2 + g3 + p + IS) .....	4.8 Pf

**RATINGS (Design Center Rating System)****Pentode Section**

Plate Voltage (Max.) .....	300 Volts
Grid No. 2 Voltage .....	See Rating Chart (Gen. Info. Sec.)
Grid No. 2 Supply Voltage (Max.) .....	300 Volts
Negative Grid No. 1 Voltage (Max.) .....	50 Volts
Positive Grid No. 1 Voltage (Max.) .....	0 Volt
Plate Dissipation (Max.) .....	3 Watts
Grid No. 2 Dissipation (Max.) .....	0.65 Watt

**Diode Section**

Peak Inverse Plate Voltage (Max.) .....	430 Volts
Peak Plate Current (Max.) .....	180 Ma
DC Plate Current (Max.) .....	45 Ma

**CHARACTERISTICS AND TYPICAL OPERATION****Class A1 Amplifier**

Plate Voltage .....	100	250	250 Volts
Grid No. 3 Voltage .....	Connected to Cathode at Socket		
Grid No. 2 Voltage .....	100	125	150 Volts
Cathode Resistor .....	150	100	68 Ohms
Plate Current .....	5.0	7.6	10.6 Ma
Grid No. 2 Current .....	2.1	3.0	4.3 Ma
Transconductance .....	3900	4500	5200 $\mu$ mhos
Plate Resistance (Approx.) .....	0.5	1.5	1.0 Megohms
Ec1 for Ib = 10 $\mu$ a (Approx.).....	-4.2	-5.5	-6.5 Volts
Average Diode Current with 10 Volts DC Applied (Test Condition Only) .....			60 Ma

**NOTE:**

(1) External Shield No. 315 connected to Pentode Cathode.

**6BY11****AUDIO OUTPUT AMPLIFIER  
FM DETECTOR****Power Pentode and  
Dual-Control Pentode**

Construction.....	Compactron T-9
Base .....	E12-70
Basing .....	12EZ
Outline .....	9-59
Maximum Diameter .....	1.188 In.
Maximum Seated Height .....	2.000 In.
Maximum Overall Height .....	2.250 In.

**ELECTRICAL DATA****HEATER OPERATION**

Heater Voltage.....	6.3 Volts
Heater Current .....	1200 Ma
Maximum Heater-Cathode Voltage	
Heater Negative with Respect to Cathode	
Total DC and Peak.....	200 Volts
Heater Positive with Respect to Cathode	
DC .....	100 Volts
Total DC and Peak.....	200 Volts

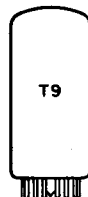
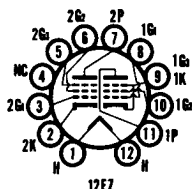

**DIRECT INTERELECTRODE CAPACITANCES**

**Section No. 1**

Grid to Plate .....	0.28 pf
Input: g to (h + 1k + 1g <sub>2</sub> + 1g <sub>3</sub> + IS) .....	12.0 pf
Output: p to (h + 1k + 1g <sub>2</sub> + 1g <sub>3</sub> + IS) .....	7.0 pf

**Section No. 2**

Grid No. 1 to Plate (Max.) .....	0.40 pf
Grid No. 3 to Plate .....	3.2 pf
Grid No. 1 to (h + 2k + 2g <sub>2</sub> + 2g <sub>3</sub> + IS) .....	7.0 pf
Grid No. 3 to (h + 2k + 2g <sub>2</sub> + 2g <sub>3</sub> + 2p + IS) .....	8.0 pf
Grid No. 1 to Grid No. 3 .....	0.15 pf
Plate No. 1 to Plate No. 2 .....	0.18 pf

**RATINGS (Design Maximum Rating System)**

**Section No. 1**

Plate Voltage .....	200 Volts
Screen Voltage .....	150 Volts
Plate Dissipation .....	10 Watts
Screen Dissipation .....	1.8 Watts
DC Cathode Current .....	65 Ma
Grid No. 1 Circuit Resistance Cathode Bias .....	1.0 Megohms

**Section No. 2**

Plate Voltage .....	300 Volts
Suppressor Voltage .....	25 Volts
Screen Supply Voltage .....	300 Volts
Positive DC Grid Voltage .....	0 Volt
Plate Dissipation .....	1.7 Watts
Screen Dissipation .....	1.0 Watts

**AVERAGE CHARACTERISTICS .**

**Section No. 1, Class A1 Amplifier**

Plate Voltage .....	170 Volts
Screen Voltage .....	140 Volts
Grid No. 1 Voltage .....	-3.0 Volts
Peak AF Grid Voltage .....	15 Volts
Plate Resistance (Approx.) .....	33,000 Ohms
Transconductance .....	4900 $\mu$ hos
Zero Signal Plate Current .....	74 Ma
Maximum Signal Plate Current .....	76 Ma
Zero Signal Screen Current .....	3.9 Ma
Maximum Signal Screen Current .....	8.3 Ma
Load Resistance .....	2500 Ohms
Total Harmonic Distortion (Approx.) .....	10 Percent
Maximum Signal Power Output .....	4.0 Watts

**Section No. 2**

Plate Voltage .....	150 Volts
Suppressor Voltage .....	0 Volt
Screen Voltage .....	100 Volts
Cathode Resistor .....	180 Ohms
Plate Resistance (Approx.) .....	110,000 Ohms
Transconductance (G1) .....	2500 $\mu$ hos
Transconductance (G3) .....	850 $\mu$ hos
Plate Current .....	1.3 Ma
Screen Current .....	2.1 Ma
E <sub>c1</sub> for I <sub>b</sub> = 20 $\mu$ a .....	-4.0 Volts
E <sub>c3</sub> for I <sub>b</sub> = 50 $\mu$ a .....	-3.0 Volts

Without Shield

**DAMPER**

**6BZ3**  
17BZ3

**Heater-Cathode Diode**

Construction .....	Compactron T-9
Base .....	Button 12 Pin, E12-70
Basing .....	.....12FX
Outline .....	.....9-60
Maximum Diameter .....	.....1.188 In.
Maximum Seated Height .....	.....2.500 In.
Maximum Overall Height .....	.....2.875 In.

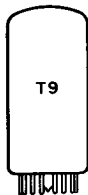
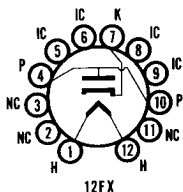

**ELECTRICAL DATA  
HEATER OPERATION**

	<b>17BZ3</b>	<b>6BZ3</b>
Heater Voltage.....	16.8	6.3 Volts
Heater Current .....	450	1200 Ma
Heater Warm-up Time .....	11	— Seconds
Maximum Heater-Cathode Voltage		
Heater Negative with Respect to Cathode		
DC .....		900 Volts
Total DC and Peak.....		4500 Volts
Heater Positive with Respect to Cathode		
DC .....		100 Volts
Total DC and Peak.....		300 Volts

**DIRECT INTERELECTRODE CAPACITANCES (Unshielded)**

Cathode to Plate and Heater.....	11 Pf
Plate to Cathode and Heater.....	8.5 Pf
Heater to Cathode .....	3.4 Pf

**RATINGS (Design Maximum Rating System)**

**Damper Service<sup>(1)</sup>**

Peak Inverse Plate Voltage (Max.) .....	4500 Volts
Plate Dissipation (Max.) .....	6.5 Watts
Steady State Peak Plate Current (Max.) .....	1200 Ma
DC Output Current (Max.) .....	200 Ma

**CHARACTERISTICS AND TYPICAL OPERATION**

Tube Voltage drop for $I_b = 350$ Ma .....	21 Volts
--	----------

**NOTE:**

(1) For operation in a 525 line, 30 frame system as described in "Standards of Good Engineering Practice for Television Broadcast Stations; Federal Communications Commission," the duty cycle of the voltage pulse must not exceed 15% of one horizontal scanning cycle.

# 6BZ6

3BZ6, 4BZ6, 12BZ6

Color Television Type

## AGC/IF AMPLIFIER

**Semi-Remote Cutoff Pentode**

Construction ..... Miniature T-5½  
 Base ..... Button 7 Pin, E7-1  
 Basing ..... 7CM  
 Outline ..... 5-2  
 Maximum Diameter ..... 0.750 In.  
 Maximum Seated Height ..... 1.875 In.  
 Maximum Overall Height ..... 2.125 In.

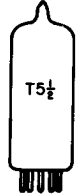
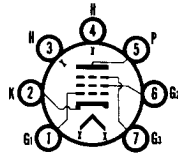

7CM

**ELECTRICAL DATA  
HEATER OPERATION**

	<b>3BZ6</b>	<b>4BZ6</b>	<b>12BZ6</b>	<b>6BZ6</b>
Heater Voltage.....	3.15	4.2	12.6	6.3 Volts
Heater Current .....	60	450	150	300 Ma
Heater Warm-up Time .....	11	11	—	— Seconds
Maximum Heater-Cathode Voltage				
Heater Negative with Respect to Cathode				
Total DC and Peak .....	300	200	200	200 Volts
DC .....	200	200	200	200 Volts
Heater Positive with Respect to Cathode				
DC .....	100	100	100	100 Volts
Total DC and Peak.....	200	200	200	200 Volts

**DIRECT INTERELECTRODE CAPACITANCES**

	<b>Shielded<sup>(1)</sup></b>	<b>Unshielded</b>
Grid No. 1 to Plate (Max.) .....	0.015	0.025 Pf
Input: $g_1$ to $(h + k + g_2 + g_3 + IS)$ .....	7.0	7.0 Pf
Output: $p$ to $(h + k + g_2 + g_3 + IS)$ .....	3.0	2.0 Pf

**RATINGS (Design Maximum Rating System)**

Plate Voltage (Max.) .....	330 Volts
Grid No. 2 Supply Voltage (Max.) .....	330 Volts
Grid No. 2 Voltage .....	See Rating Chart (Gen. Info. Sec.)
Plate Dissipation (Max.) .....	2.3 Watts
Grid No. 2 Dissipation (Max.) .....	0.55 Watt
Grid No. 1 Circuit Resistance	
Fixed Bids (Max.) .....	0.25 Megohm
Cathode Bias (Max.) .....	1.0 Megohm

**CHARACTERISTICS AND TYPICAL OPERATION**

**Class A1 Amplifier**

Plate Voltage .....	125 Volts
Grid No. 2 Voltage .....	125 Volts
Grid No. 3 Voltage .....	Connected to Cathode at Socket
Cathode Bias Resistor .....	56 Ohms
Plate Current .....	14 Ma
Grid No. 2 Current .....	3.6 Ma
Transconductance .....	8000 $\mu$ mhos
Plate Resistance (Approx.) .....	260,000 Ohms
Ec1 for Gm = 50 $\mu$ mhos (Approx.) .....	-19 Volts
Gm with Ec1 = -4.5 V, RK = 0 .....	700 $\mu$ mhos

**NOTE:**

(1) External Shield No. 316 connected to Pin No. 2 (cathode) at socket.

**VHF CASCODE AMPLIFIER**

**6BZ8**  
4BZ8

**Medium Mu-Semi-remote Cutoff Double Triode**

Construction .....	Miniature T-6½
Base .....	Button 9 Pin, E9-1
Basing .....	9AJ
Outline .....	6-2
Maximum Diameter .....	0.875 In.
Maximum Seated Height .....	1.937 In.
Maximum Overall Height .....	2.187 In.

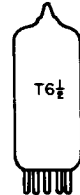
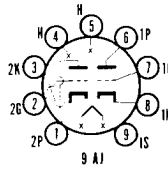

**ELECTRICAL DATA**

**HEATER OPERATION**

	<b>4BZ8</b>	<b>6BZ8</b>
Heater Voltage (AC or DC) .....	4.2	6.3 Volts
Heater Current .....	600	400 Ma
Heater Warm-up Time .....	11	— Seconds
Maximum Heater-Cathode Voltage		
Heater Negative with Respect to Cathode		
Total DC and Peak .....		200 Volts
Heater Positive with Respect to Cathode		
DC .....		100 Volts
Total DC and Peak .....		200 Volts

**DIRECT INTERELECTRODE CAPACITANCES (Shielded)**

	<b>Section No. 1</b>	<b>Section No. 2</b>
<b>Cascode Operation</b>		
Grid to Plate .....	1.15	— Pf
Plate to Cathode .....	—	0.15 Pf
Triode No. 1 Plate to Triode No. 2 Plate .....	0.010	— Pf
<b>RATINGS (Design Maximum Rating System) (Each Section)</b>		
Plate Voltage (Max.) .....		250 Volts
Plate Dissipation (Max.) .....		2.2 Watts
Cathode Current (Max.) .....		20 Ma
Grid Circuit Resistance (Max.) .....		0.1 Megohm

**CHARACTERISTICS AND TYPICAL OPERATION (Each Section)**

**Class A1 Amplifier**

Plate Voltage .....	125 Volts
Cathode Resistor .....	100 Ohms
Plate Current .....	10 Ma
Transconductance .....	8000 $\mu$ mhos
Amplification Factor .....	45
Plate Resistance .....	5600 Ohms
Grid Voltage (Approx.) for Gm = 50 $\mu$ mhos .....	-13 Volts
Cascode Operation at Eb = 250 Volts, Ec1 = -0.5 Volts	
Transconductance .....	10,000 $\mu$ mhos
Plate Current .....	15 Ma

**NOTE:**

(1) Use external shield No. 315.

# 6C4

Color Television Type

## RF OSCILLATOR, AMPLIFIER, or DETECTOR

**Medium Mu Triode**

Construction ..... Miniature T-5½  
 Base ..... Button 7 Pin, E7-1  
 Basing ..... 6BG  
 Outline ..... 5-2  
 Maximum Diameter ..... 0.750 In.  
 Maximum Seated Height ..... 1.875 In.  
 Maximum Overall Height ..... 2.125 In.

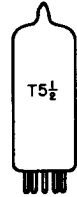
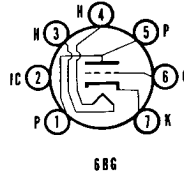

**ELECTRICAL DATA**

**HEATER OPERATION**

Heater Voltage.....	6.3 Volts
Heater Current.....	150 Ma
Maximum Heater-Cathode Voltage	
Heater Negative with Respect to Cathode	
Total DC and Peak .....	200 Volts
Heater Positive with Respect to Cathode	
DC .....	100 Volts
Total DC and Peak.....	200 Volts

**DIRECT INTERELECTRODE CAPACITANCES**

	Shielded <sup>(1)</sup>	Unshielded
Grid to Plate .....	1.4	1.6 Pf
Input: (g to h + k) .....	1.8	1.8 Pf
Output: (p to h + k) .....	2.5	1.3 Pf

**RATINGS (Design Center Rating System)**

	Class A1 Amplifier	Class C Telegraphy
Plate Voltage (Max.) .....	300	300 Volts
Plate Dissipation (Max.) .....	3.5	5.0 Watts
Plate Current (Max.) .....	—	25 Ma
Negative DC Grid Voltage (Max.) .....	—	-50 Volts
DC Grid Current (Max.) .....	—	8 Ma
Grid Circuit Resistance		
Fixed Bias (Max.) .....	0.25	0.25 Megohm
Cathode Bias (Max.) .....	1.0	1.0 Megohm

**CHARACTERISTICS AND TYPICAL OPERATION**

**Class A1 Amplifier**

Plate Voltage .....	100	250 Volts
Grid Voltage <sup>(2)</sup> .....	0	-8.5 Volts
Plate Current .....	11.8	10.5 Ma
Plate Resistance (Approx.) .....	6250	7700 Ohms
Transconductance .....	3100	2200 μmhos
Amplification Factor .....	19.5	17
Grid Voltage (Approx.) for Ib = 10 μa .....	-10	-25 Volts

**Class C Telegraphy <sup>(3)</sup>**

Plate Voltage .....	300 Volts
Grid Voltage .....	-27 Volts
Plate Current .....	25 Ma
Grid Current (Approx.) .....	7 Ma
Grid Driving Power (Approx.) .....	0.35 Watt
Power Output (Approx.) .....	5.5 Watts

**NOTES:**

- (1) Shield No. 316 connected to cathode.
- (2) Transformer or impedance-type input coupling devices are recommended to minimize resistance in the grid circuit.
- (3) Approximately 2.5 watts output can be obtained when the 6C4 is used at 150 megacycles as an oscillator with a grid resistor of 10,000 Ohms and with maximum rated input.



**AMPLIFIER, PHASE INVERTER**

**6C10**

**Triple High Mu Triode**

Construction.....Compactron T-9  
 Base .....Button 12 Pin, E12-70  
 Basing .....12BQ  
 Outline .....9-56  
 Maximum Diameter .....1.188 In.  
 Maximum Seated Height .....1.500 In.  
 Maximum Overall Height .....1.875 In.

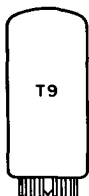
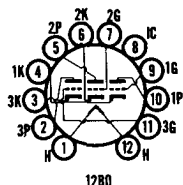

**ELECTRICAL DATA**

**HEATER OPERATION**

Heater Voltage..... 6.3 Volts  
 Heater Current ..... 600 Ma  
 Maximum Heater-Cathode Voltage  
 Heater Negative with Respect to Cathode  
 Total DC and Peak..... 200 Volts  
 Heater Positive with Respect to Cathode  
 DC ..... 100 Volts  
 Total DC and Peak..... 200 Volts

**DIRECT INTERELECTRODE CAPACITANCES (Unshielded)**

	Section 1	Section 2	Section 3
Grid to Plate (g to p).....	1.7	1.7	1.7 Pf
Input: g to (h + k + IS).....	1.6	1.6	1.6 Pf
Output: p to (h + k + IS).....	0.30	0.24	0.34 Pf

**RATINGS (Design Maximum Rating System) (Each Section)**

Plate Voltage (Max.) ..... 330 Volts  
 Plate Dissipation (Max.) ..... 1.0 Watt  
 Total Plate Dissipation (All Plates) (Max.) ..... 3.0 Watts  
 Positive DC Grid No. 1 Voltage..... 0 Volt  
 Negative DC Grid No. 1 Voltage..... 50 Volts  
 Grid Circuit Resistance  
 With Fixed Bias (Max.) ..... 0.25 Megohm  
 With Cathode Bias (Max.) ..... 1.0 Megohm

**CHARACTERISTICS AND TYPICAL OPERATION (Each Section)**

**Class A1 Amplifier**

Plate Voltage ..... 100 250 Volts  
 Grid Voltage ..... -1.0 -2.0 Volts  
 Amplification Factor ..... 100 100  
 Plate Resistance (Approx.) ..... 80,000 62,500 Ohms  
 Transconductance ..... 1250 1600  $\mu$ mhos  
 Plate Current ..... 0.5 1.2 Ma

**AUDIO POWER AMPLIFIER**

**6CA7/EL34**

**Beam Pentode**

Construction .....Octal, Metal  
 Base .....Octal 8 Pin  
 Basing .....8ET  
 Outline .....  
 Maximum Diameter .....1.500 In.  
 Maximum Seated Height .....3.875 In.  
 Maximum Overall Height .....4.438 In.

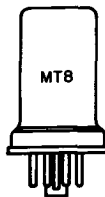
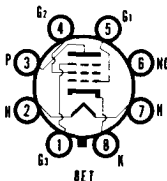

**ELECTRICAL DATA**

**HEATER OPERATION**

Heater Voltage..... 6.3 Volts  
 Heater Current ..... 1500 Ma

Maximum Heater Cathode Voltage	
Heater Negative with Respect to Cathode	
Total DC and Peak.....	200 Volts
Heater Positive with Respect to Cathode	
DC .....	100 Volts
Total DC and Peak.....	200 Volts

**DIRECT INTERELECTRODE CAPACITANCES (Unshielded)**

Grid No. 1 to Plate .....	1.0 Pf
Input .....	15.5 Pf
Output .....	7.2 Pf

**RATINGS (Design Center Rating System)**

	Triode Conn.	Pentode Conn.
Plate Voltage (Max.) .....	500	800 Volts
Grid No. 2 Voltage (Max.) .....	—	425 Volts
Plate Dissipation (Max.) .....	30	25 Watts
Grid No. 2 Dissipation (Max.) .....	—	8.0 Watts
Cathode Current (Max.) .....	—	150 Ma
Grid No. 1 Circuit Resistance Cathode Bias (Max.) <sup>(1)</sup> .....	0.7	0.7 Megohm

**CHARACTERISTICS AND TYPICAL OPERATION**

	Triode Operation Push-Pull	Pentode Operation Single Tube	
Plate Voltage .....	400	265	300 Volts
Grid No. 2 Voltage .....	—	250	300 Volts
Cathode Resistor .....	220	—	190 Ohms
Grid No. 1 Voltage .....	—	-13.5	— Volts
A-F Grid Voltage (RMS) .....	—	8.7	8.2 Volts
Zero Signal Plate Current.....	130	100	83 Ma
Max. Signal Plate Current .....	142	—	— Ma
Zero Signal Grid No. 2 Current.....	—	15	13 Ma
Transconductance .....	—	11K	— $\mu$ mhos
Plate Resistance.....	—	15K	— Ohms
Load Resistance .....	5K	2K	3.5K Ohms
Power Output .....	16.5	11	11 Watts
Total Harmonic Distortion .....	3	10	10 Percent

**Class AB1 Push-Pull (Pentode Operation)**

Plate Voltage .....	375	450	400 Volts
Grid No. 2 Voltage .....	375	450	400 Volts
Grid No. 2 Resistor .....	470	1000	800 Ohms
Grid No. 1 Voltage .....	—	—	-36 Volts
Cathode Resistor .....	130	232	— Ohms
A-F Grid Voltage (RMS) .....	20	27	25 Volts
Zero Signal Plate Current.....	150	120	60 Ma
Maximum Signal Plate Current .....	188	143	221 Ma
Zero Signal Grid No. 2 Current.....	25	20	9 Ma
Maximum Signal Grid No. 2 Current .....	39	44	46 Ma
Load Resistance (P to P) .....	3.5K	6.5K	3.5K Ohms
Power Output .....	35	40	54 Watts
Total Harmonic Distortion .....	1.7	5.1	1.6 Percent

**Class AB1 Push-Pull (Ultra-Linear Operation)****Grid No. 2 at 43% of Primary Winding**

Plate Voltage .....	430	430 Volts
Cathode Resistor .....	235	235 Ohms
A-F Grid Voltage (RMS) .....	17.5	25 Volts
Zero Signal Plate Current.....	125	125 Ma
Maximum Signal Plate Current .....	130	140 Ma
Zero Signal Grid No. 2 Current.....	20	20 Ma
Maximum Signal Grid No. 2 Current .....	20.4	28 Ma
Load Resistance (P to P) .....	6K	6K Ohms
Power Output .....	20	34 Watts
Total Harmonic Distortion .....	0.35	2.5 Percent

**NOTE:**

(1) The maximum permissible limit for Grid No. 1 Resistor in a Class B Circuit is 0.5 Megohm.

Color Television Type  
**VIDEO AMPLIFIER  
CATHODE FOLLOWER**

**6CA11**  
11CA11

**Dissimilar-Double-Triode Pentode**

Construction ..... Compactron T-9  
 Base ..... E12-70  
 Basing ..... 12HN  
 Outline ..... 9-58  
 Maximum Diameter ..... 1.188 In.  
 Maximum Seated Height ..... 2.000 In.  
 Maximum Overall Height ..... 2.375 In.

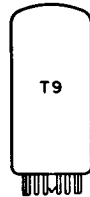
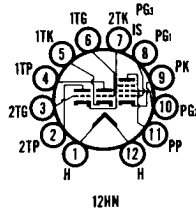

**ELECTRICAL DATA  
HEATER OPERATION**

Heater Voltage .....	<b>11CA11</b>	<b>6CA11</b>
Heater Current .....	10.7	6.3 Volts
Heater Warm-up Time .....	600	1020 Ma
Maximum Heater-Cathode Voltage	11	— Seconds
Heater Negative with Respect to Cathode		
Total DC and Peak .....		200 Volts
Heater Positive with Respect to Cathode		
DC Component .....		100 Volts
Total DC and Peak .....		200 Volts

**DIRECT INTERELECTRODE CAPACITANCES (Unshielded)**

**Triode (Section 1)**

Grid to Plate .....	2.7 pf
Input: 1Tg to (1Tk+2Tk+Pk+Pg3+h+IS) .....	4.7 pf
Output: 1Tp to (1Tk+2Tk+Pk+Pg3+h+IS) .....	4.0 pf

**Triode (Section 2)**

Grid to Plate .....	2.1 pf
Input: 2Tg to (2Tk+Pk+Pg3+h+IS) .....	2.8 pf
Output: 2Tp to (2Tk+Pk+Pg3+h+IS) .....	2.0 pf

**Pentode**

Grid No. 1 to Plate .....	0.13 pf
Input: Pg1 to (2Tk+Pk+Pg2+Pg3+h+IS) .....	12.3 pf
Output: Pp to (2Tk+Pk+Pg2+Pg3+h+IS) .....	4.6 pf

**Coupling**

Pentode Plate to Triode Plate (Section 2) (Max.) .....	0.045 pf
Triode Plate (Section 1) to Triode Plate (Section 2) (Max.) .....	0.100 pf

**RATINGS (Design Maximum Rating System)**

**Triode No. 1**

Plate Voltage (Max.) .....	330 Volts
Positive DC Grid Voltage (Max.) .....	0 Volt
Plate Dissipation (Max.) .....	1.5 Watts
Grid Circuit Resistance	
With Fixed Bias (Max.) .....	0.5 Megohm
With Cathode Bias (Max.) .....	1.0 Megohm

**Triode No. 2**

Plate Voltage (Max.) .....	330 Volts
Positive DC Grid Voltage (Max.) .....	0 Volt
Plate Dissipation (Max.) .....	1.5 Watts
Grid Circuit Resistance	
With Fixed Bias (Max.) .....	0.5 Megohm
With Cathode Bias (Max.) .....	1.0 Megohm

**Pentode Section**

Plate Voltage (Max.) .....	330 Volts
Screen-Supply Voltage (Max.) .....	330 Volts
Screen Voltage .....	See Rating Chart (Gen. Info. Sec.)
Positive DC Grid No. 1 Voltage (Max.) .....	0 Volt
Plate Dissipation (Max.) .....	5.0 Watts
Screen Dissipation (Max.) .....	1.0 Watts
Grid No. 1 Circuit Resistance	
With Fixed Bias (Max.) .....	10,000 Ohms
With Cathode Bias (Max.) .....	10,000 Ohms

**CHARACTERISTICS AND TYPICAL OPERATION**

**Triode No. 1**

Plate Voltage .....	200 Volts
Cathode Bias Resistor .....	270 Ohms

Grid Voltage .....		-2.0 Volts
Amplification Factor .....		63
Plate Resistance (Approx.) .....		10,000 Ohms
Transconductance .....		6300 $\mu$ mhos
Plate Current .....		7.1 Ma
Grid Voltage (Approx.) $I_b = 100 \mu a$ .....		-6.3 Volts
<b>Triode No. 2</b>		
Plate Voltage .....		200 Volts
Cathode-Bias Resistor .....		270 Ohms
Amplification Factor .....		69
Plate Resistance (Approx.) .....		12,400 Ohms
Transconductance .....		5500 $\mu$ mhos
Plate Current .....		7.1 Ma
Grid Voltage (Approx.) $I_b = 100 \mu a$ .....		-5.5 Volts
<b>Pentode Section</b>		
Plate Voltage .....	40	200 Volts
Screen Voltage .....	120	120 Volts
Grid No. 1 Voltage .....	0	— Volt
Cathode Bias Resistor .....		65 Ohms
Plate Resistance (Approx.) .....	—	490,000 Ohms
Transconductance .....	—	21,200 $\mu$ mhos
Plate Current .....	68	27.5 Ma
Screen Current .....	17.6	4.9 Ma
Grid No. 1 Voltage (Approx.) $I_b = 100 \mu a$ .....	—	-5.0 Volts

# 6CB5A

*Color Television Type*

## HORIZONTAL DEFLECTION AMPLIFIER

### Beam Power Pentode

Construction .....	Octal T-12
Base .....	Octal 8 Pin
Top Cap .....	C1-1
Basing .....	.8GD
Outline .....	.12-21
Maximum Diameter .....	1.563 In.
Maximum Seated Height .....	4.250 In.
Maximum Overall Height .....	5.000 In.

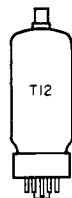
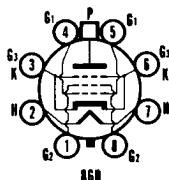

### ELECTRICAL DATA

#### HEATER OPERATION

Heater Voltage .....	6.3 Volts
Heater Current .....	2500 Ma
Maximum Heater-Cathode Voltage	
Heater Negative with Respect to Cathode	
Total DC and Peak .....	200 Volts
Heater Positive with Respect to Cathode	
DC .....	100 Volts
Total DC and Peak .....	200 Volts

#### DIRECT INTERELECTRODE CAPACITANCES (Unshielded)

Grid to Plate .....	0.4 Pf
Input .....	22 Pf
Output .....	10 Pf

#### RATINGS (Design Maximum Rating System)

##### Horizontal Deflection Amplifier<sup>(1)</sup>

Plate Supply Voltage (DC and Boost) (Max.) .....	800 Volts
Peak Positive Pulse Plate Voltage (Abs. Max.) .....	6800 Volts
Plate Dissipation (Max.) .....	23 Watts
Peak Negative Pulse Plate Voltage (Max.) .....	-1650 Volts
DC Grid No. 2 Voltage (Max.) .....	220 Volts
DC Grid No. 1 Voltage (Max.) .....	-55 Volts
Grid No. 2 Dissipation (Max.) .....	4 Watts
Peak Negative Pulse Grid No. 1 Voltage (Max.) .....	220 Volts
DC Plate Current (Max.) .....	240 Ma
Grid No. 1 Circuit Resistance (Max.) .....	0.47 Megohm
Bulb Temperature (At Hottest Point) (Max.) .....	220 °C

**CHARACTERISTICS AND TYPICAL OPERATION**

Plate Voltage .....	175 Volts
Grid No. 2 Voltage .....	175 Volts
Grid No. 1 Voltage .....	-30 Volts
Plate Current .....	90 Ma
Grid No. 2 Current .....	6.0 Ma
Transconductance .....	8800 $\mu$ mhos
Plate Resistance.....	5000 Ohms
Triode Amplification Factor.....	3.8
Ec1 for Ib = 1 Ma .....	-60 Volts

**PLATE KNEE CHARACTERISTICS**

Eb = 75 V, Ec2 = 150 V, Ec1 = 0 V  
Ib = 460 Ma, Ic2 = 42 Ma

**NOTE:**

(1) For operation in a 525 line, 30 frame system as described in "Standards of Good Engineering Practice for Television Broadcast Stations; Federal Communications Commission," the duty cycle of the voltage pulse must not exceed 15% of one horizontal scanning cycle.

Color Television Type  
**RF/IF AMPLIFIER**

**6CB6A**  
4CB6, 3CB6/3CF6

**Sharp Cutoff Pentode**

Construction ..... Miniature T-5½  
Base ..... Button 7 Pin  
Basing ..... .7CM  
Outline ..... 5-2  
Maximum Diameter ..... 0.750 In.  
Maximum Seated Height ..... 1.875 In.  
Maximum Overall Height ..... 2.125 In.

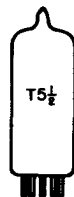
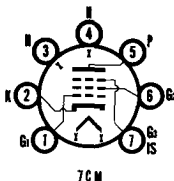

**ELECTRICAL DATA**

**HEATER OPERATION**

	3CB6/3CF6	4CB6	6CB6A
Heater Voltage.....	3.15	4.2	6.3 Volts
Heater Current .....	600	450	300 Ma
Heater Warm-up Time .....	11	11	11 Seconds
Maximum Heater-Cathode Voltage			
Heater Negative with Respect to Cathode			200 Volts
Total DC and Peak.....			
Heater Positive with Respect to Cathode			100 Volts
DC .....			200 Volts
Total DC and Peak.....			

**DIRECT INTERELECTRODE CAPACITANCES**

	Shielded <sup>(1)</sup>	Unshielded
Grid No. 1 to Plate (Max.) .....	0.015	0.025 Pf
Input: g1 to (h + k + g2 + g3 + IS) .....	6.5	6.5 Pf
Output: p to (h + k + g2 + g3 + IS) .....	3.0	2.0 Pf

**RATINGS (Design Maximum Rating System)**

Plate Voltage (Max.) .....	330 Volts
Grid No. 2 Supply Voltage (Max.) .....	330 Volts
Grid No. 2 Voltage .....	See Rating Chart (Gen. Info. Sec.)
Plate Dissipation (Max.) .....	2.3 Watts
Grid No. 2 Dissipation (Max.) .....	0.55 Watt

**CHARACTERISTICS AND TYPICAL OPERATION**

**Class A1 Amplifier**

Plate Voltage .....	125 Volts
Grid No. 3 Voltage .....	Connected to Cathode at Socket
Grid No. 2 Voltage .....	125 Volts
Cathode Bias Resistor .....	56 Ohms
Plate Current .....	13.0 Ma
Grid No. 2 Current .....	3.7 Ma
Transconductance .....	8000 $\mu$ mhos
Plate Resistance (Approx.) .....	0.28 Megohm
Grid No. 1 Voltage for Ib = 20 $\mu$ a (Approx.) .....	-6.5 Volts

**NOTE:**

(1) External Shield No. 316 connected to Pin 2.

**6CD6GA**

25CD6GB, 35CD6GA

Color Television Type

**HORIZONTAL DEFLECTION  
AMPLIFIER****Beam Power Pentode**

Construction ..... Octal T-12  
 Base ..... 5 or 8 Pin, B5-123 or B8-110  
 Top Cap ..... C1-1  
 Basing<sup>(1)</sup> ..... 5BT  
 Outline ..... 12-21  
 Maximum Diameter ..... 1.563 In.  
 Maximum Seated Height ..... 4.250 In.  
 Maximum Overall Height ..... 5.000 In.

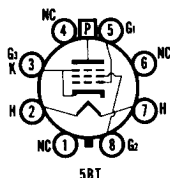
**ELECTRICAL DATA  
HEATER OPERATION**

	35CD6GA	25CD6GB	6CD6GA
Heater Voltage.....	35	25	6.3 Volts
Heater Current.....	450	600	2500 Ma
Heater Warm-up Time .....	11	11	— Seconds
Maximum Heater-Cathode Voltage			
Heater Negative with Respect to Cathode			
Total DC and Peak.....			200 Volts
Heater Positive with Respect to Cathode			
DC .....			100 Volts
Total DC and Peak.....			200 Volts

**DIRECT INTERELECTRODE CAPACITANCES**

Grid No. 1 to Plate .....	1.1 Pf
Input .....	22 Pf
Output .....	8.5 Pf

**RATINGS (Design Center Rating System)****Horizontal Deflection Amplifier<sup>(2)</sup>**

DC Plate Supply Voltage (Boost + DC Power Supply) (Max.) .....	700 Volts
Peak Positive Pulse Plate Voltage (Abs. Max.).....	7000 Volts
Peak Negative Pulse Plate Voltage (Max.).....	1500 Volts
Peak Negative Grid No. 1 Voltage (Max.) .....	200 Volts
DC Grid No. 2 Voltage (Max.).....	175 Volts
Plate Dissipation (Max.) <sup>(3)</sup> .....	20 Watts
Grid No. 2 Dissipation (Max.) .....	3.0 Watts
Average Cathode Current (Max.).....	200 Ma
Peak Cathode Current (Max.) .....	700 Ma
Grid No. 1 Circuit Resistance (Max.).....	0.47 Megohm
Bulb Temperature (At Hottest Point) (Max.) .....	225 °C

**CHARACTERISTICS AND TYPICAL OPERATION**

Plate Voltage .....	175 Volts
Grid No. 2 Voltage .....	175 Volts
Grid No. 1 Voltage .....	-30 Volts
Plate Current .....	75 Ma
Grid No. 2 Current .....	5.5 Ma
Transconductance .....	7700 μmhos
Amplification Factor <sup>(4)</sup> .....	3.9
Plate Resistance.....	7200 Ohms
Ec1 for Ib = 1.0 Ma (Approx.) .....	-55 Volts

**INSTANTANEOUS PLATE KNEE VALUES**

Eb = 60 V, Ec2 = 100 V, and Ec1 = 0 V

Ib = 230 Ma and Ic2 = 21 Ma

**NOTES:**

- (1) Horizontal operation permitted if plane of Pins 2 and 7 is vertical.
- (2) For operation in a 525 line, 30 frame system as described in "Standards of Good Engineering Practice for Television Broadcast Stations; Federal Communications Commission," the duty cycle of the voltage pulse must not exceed 15% of one horizontal scanning cycle.
- (3) In stages operating with grid leak bias, an adequate cathode bias resistor or other suitable means is required to protect the tube in the absence of excitation.
- (4) Amplification factor with tube operation as a triode with 175 Volts on the plate and Grid No. 2 and -30 Volts on Grid No. 1.

Color Television Type  
**DAMPER**

**6CE3/6CD3**  
34CE3, 34CD3

**Heater-Cathode Diode**

Construction..... Compactron T-9  
Base ..... Button 12 Pin, E12-70  
Basing ..... 12GK  
Outline ..... 9-62  
Maximum Diameter ..... 1.188 In.  
Maximum Seated Height ..... 3.000 In.  
Maximum Overall Height ..... 3.375 In.

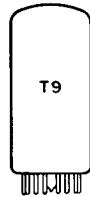
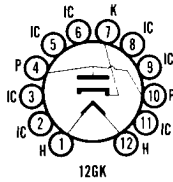

**ELECTRICAL DATA**

**HEATER OPERATION**

	<b>34CE3, 34CD3</b>	<b>6CE3/6CD3</b>
Heater Voltage.....	34.5	6.3 Volts
Heater Current .....	450	2500 Ma
Heater Warm-up Time .....	11	— Seconds
Maximum Heater-Cathode Voltage		
Heater Negative with Respect to Cathode		
DC .....		900 Volts
Total DC and Peak.....		5000 Volts
Heater Positive with Respect to Cathode		
DC .....		100 Volts
Total DC and Peak.....		300 Volts

**DIRECT INTERELECTRODE CAPACITANCES (Unshielded)**

Cathode to Plate and Heater.....	18.0 Pf
Plate to Cathode and Heater.....	13.0 Pf
Heater to Cathode .....	5.5 Pf

**RATINGS (Design Maximum Rating System)**

**Damper Service**

Peak Inverse Plate Voltage (Max.) .....	5000 Volts
Plate Dissipation (Max.) .....	11 Watts
Steady State Peak Plate Current (Max.) .....	1500 Ma
DC Plate Current (Max.) .....	350 Ma

**CHARACTERISTICS AND TYPICAL OPERATION**

Tube Voltage Drop for Ib = 680 Ma .....	20 Volts
---	----------

**NOTE:**

(1) For operation in a 525 line, 30 frame system as described in "Standards of Good Engineering Practice for Television Broadcast Stations; Federal Communications Commission," the duty cycle of the voltage pulse must not exceed 15% of one horizontal scanning cycle.

Color Television Type  
**DAMPER**

**6CG3**  
19CG3, 25CG3

**Heater-Cathode Diode**

Construction..... Compactron T-9  
Base ..... Button 12 Pin, E12-70  
Basing<sup>(1)</sup> ..... 12HF  
Outline ..... 9-62  
Maximum Diameter ..... 1.188 In.  
Maximum Seated Height ..... 3.000 In.  
Maximum Overall Height ..... 3.375 In.

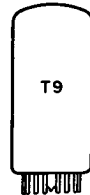
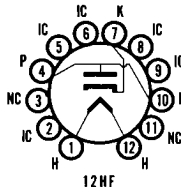

**ELECTRICAL DATA**

**HEATER OPERATION**

	<b>19CG3</b>	<b>25CG3</b>	<b>6CG3</b>
Heater Voltage.....	19.0	25.0	6.3 Volts
Heater Current .....	600	450	1800 Ma
Heater Warm up Time .....	11	11	— Seconds
Maximum Heater-Cathode Voltage			
Heater Negative with Respect to Cathode			
DC .....			900 Volts
Total DC and Peak.....			5000 Volts

Heater Positive with Respect to Cathode

DC .....	100 Volts
Total DC and Peak.....	300 Volts

**DIRECT INTERELECTRODE CAPACITANCES (Unshielded)**

Cathode to Plate and Heater.....	16.0 Pf
Plate to Cathode and Heater.....	13.0 Pf
Heater to Cathode .....	4.0 Pf

**RATINGS (Design Maximum Rating System)**

**Damper Service<sup>(2)</sup>**

Peak Inverse Plate Voltage (Max.) .....	5000 Volts
Plate Dissipation (Max.) .....	6.5 Watts
Steady State Peak Plate Current (Max.) .....	2100 Ma
DC Plate Current (Max.) .....	350 Ma

**CHARACTERISTICS AND TYPICAL OPERATION**

Tube Voltage Drop for Ib = 700 Ma .....	20 Volts
---	----------

**NOTES:**

- (1) Pins designated Internal Connection (IC) may or may not have connections to internal elements depending on the manufacturer. To maintain interchangeability do not use these pins for external connection.
- (2) For operation in a 525 line, 30 frame system as described in "Standards of Good Engineering Practice for Television Broadcast Stations; Federal Communications Commission," the duty cycle of the voltage pulse must not exceed 15% of one horizontal scanning cycle.

6CG7/6FQ7

8CG7/8FQ7, 12FQ7

Color Television Type

HORIZONTAL and VERTICAL  
DEFLECTION OSCILLATOR

**Medium Mu Twin Triodes**

Construction .....	Miniature T-6½
Base .....	Button 9 Pin, E9-1
Basing .....	9LP
Outline .....	6-3
Maximum Diameter .....	0.875 In.
Maximum Seated Height .....	2.375 In.
Maximum Overall Height .....	2.625 In.

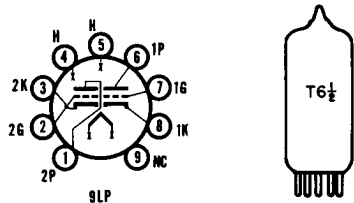

**ELECTRICAL DATA**

**HEATER OPERATION**

	12FQ7	8CG7/8FQ7	6CG7/6FQ7
Heater Voltage.....	12.6	8.4	6.3 Volts
Heater Current .....	300	450	600 Ma
Heater Warm-up Time .....	11	11	11 Seconds
Maximum Heater-Cathode Voltage			
Heater Negative with Respect to Cathode			
Total DC and Peak.....			200 Volts
Heater Positive with Respect to Cathode			
DC .....			100 Volts
Total DC and Peak.....			200 Volts

**DIRECT INTERELECTRODE CAPACITANCES (Unshielded)**

	Section No. 1	Section No. 2
Grid to Plate .....	3.6	3.8 Pf
Input: g to (h + k) .....	2.4	2.4 Pf
Output: p to (h + k) .....	0.34	0.26 Pf
Plate of Section No. 1 to Plate of Section No. 2 .....	1.0	Pf

**RATINGS (Design Maximum Rating System)**

	Class A1 Amplifier	Horiz. Defl. Oscillator <sup>(1)</sup>	Vert. Defl. Oscillator <sup>(1)</sup>
DC Plate Voltage (Max.) .....	330	330	330 Volts
Peak Negative Pulse Grid Voltage (Max.) .....	—	660	440 Volts
Positive Grid Voltage (Max.) .....	0	—	— Volt
Plate Dissipation <sup>(2)</sup>			
Each Plate (Max.).....	4	4	4 Watts
Both Plates (Max.).....	5.7	5.7	5.7 Watts
Average Cathode Current (Max.).....	22	22	22 Ma
Peak Cathode Current (Max.) .....	—	330	77 Ma
Grid Circuit Resistance			
Fixed Bias (Max.) .....	1.0	—	— Megohm
Self Bias (Max.) .....	—	2.2	2.2 Megohms



**CHARACTERISTICS AND TYPICAL OPERATION**

Plate Voltage .....	90	250 Volts
Grid No. 1 Voltage .....	0	-8 Volts
Plate Current .....	10	9 Ma
Transconductance .....	3000	2600 $\mu$ mhos
Amplification Factor .....	20	20
Plate Resistance (Approx.) .....	6700	7700 Ohms
Grid Voltage for $I_b = 10 \mu$ a (Approx.) .....	-7	-18 Volts
Plate Current at $E_c = -12.5$ Vdc. ....	—	1.3 Ma

**NOTES:**

- (1) For operation in a 525 line, 30 frame system as described in "Standards of Good Engineering Practice for Television Broadcast Stations; Federal Communications Commission," the duty cycle of the voltage pulse must not exceed 15% of one horizontal scanning cycle.
- (2) In stages operating with grid leak bias, an adequate bias resistor or other suitable means is required to protect the tube in the absence of excitation.

Color Television Type

## VHF OSCILLATOR and MIXER

# 6CG8A

5CG8

**Medium Mu Triode and Sharp Cutoff Pentode**

Construction ..... Miniature T-6½  
 Base ..... Button 9 Pin, E9-1  
 Basing ..... 9GF  
 Outline ..... 6-2  
 Maximum Diameter ..... 0.875 In.  
 Maximum Seated Height ..... 1.937 In.  
 Maximum Overall Height ..... 2.187 In.

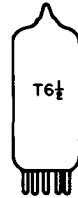
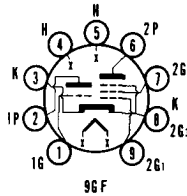

**ELECTRICAL DATA**

**HEATER OPERATION**

	<b>5CG8</b>	<b>6CG8A</b>
Heater Voltage.....	4.7	6.3 Volts
Heater Current .....	600	450 Ma
Heater Warm-up Time .....	11	11 Seconds
Maximum Heater-Cathode Voltage		
Heater Negative with Respect to Cathode		
Total DC and Peak.....		200 Volts
Heater Positive with Respect to Cathode	/	
DC .....		100 Volts
Total DC and Peak.....		200 Volts

**DIRECT INTERELECTRODE CAPACITANCES**

	<b>Shielded <sup>(1)</sup></b>	<b>Unshielded</b>
<b>Triode Section</b>		
Grid to Plate .....	1.5	1.5 Pf
Input: g to (h + k) .....	2.4	2.0 Pf
Output: p to (h + k) .....	1.0	0.5 Pf
<b>Pentode Section</b>		
Grid No. 1 to Plate (Max.).....	0.02	0.04 Pf
Input: g1 to (k + g3 + g2 + h) .....	4.8	4.6 Pf
Output: p to (k + g3 + g2 + h) .....	1.6	0.9 Pf
<b>Coupling</b>		
Pentode Grid No. 1 to Triode Plate (Max.) .....	0.04	0.05 Pf
Pentode Plate to Triode Plate (Max.) .....	0.008	0.05 Pf
Heater to Cathode .....	5.5 <sup>(2)</sup>	5.5 Pf

**RATINGS (Design Maximum Rating System)**

	<b>Triode Section</b>	<b>Pentode Section</b>
<b>Converter Service</b>		
Plate Voltage (Max.) .....	275	275 Volts
Grid No. 2 Supply Voltage (Max.) .....	—	275 Volts
Grid No. 2 Voltage .....	See Rating Chart (Gen. Info. Sec.)	
Plate Dissipation (Max.) .....	1.7	2.3 Watts

Grid No. 2 Dissipation:	
For Grid No. 2 Voltages up to 137.5 Volts .....	0.45 Watt
For Grid No. 2 Voltages between 137.5 and 275 Volts .....	See Rating Chart (Gen. Info. Sec.)
Grid No. 1 Input .....	0.5 Watt Max.
Positive Grid No. 1 Voltage (Max.) .....	0 Volt
Grid No. 1 Circuit Resistance	
Fixed Bias (Max.) .....	0.1 Megohm
Self Bias (Max.) .....	0.5 Megohm

**CHARACTERISTICS AND TYPICAL OPERATION**

	<b>Triode Section</b>	<b>Pentode Section</b>
Plate Voltage .....	125	125 Volts
Grid No. 2 Voltage .....	—	125 Volts
Cathode Bias Resistor .....	100	200 Ohms
Plate Current .....	8.5	7.7 Ma
Grid No. 2 Current .....	—	1.6 Ma
Transconductance .....	6500	5500 $\mu$ mhos
Amplification Factor .....	40	—
Plate Resistance (Approx.) .....	6000	300,000 Ohms
E <sub>c1</sub> for I <sub>b</sub> = 10 $\mu$ a (Approx.) .....	-7	-6.5 Volts

**NOTES:**

- (1) Shield No. 315 connected to cathode.
- (2) Shield No. 315 connected to ground.



**Heater-Cathode Diode**

Construction .....	Novar T-9
Base .....	Buton 9 Pin, E9-75
Basing .....	9SD
Outline .....	9-87
Maximum Diameter .....	1.188 In.
Maximum Seated Height .....	3.330 In.
Maximum Overall Height .....	3.710 In.

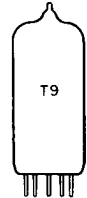
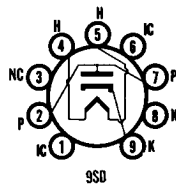

**ELECTRICAL DATA**

**HEATER OPERATION**

Heater Voltage .....	6.3 Volts
Heater Current .....	2500 Ma
Maximum Heater-Cathode Voltage	
Heater Negative with Respect to Cathode	
DC .....	900 Volts
Total DC and Peak .....	5000 Volts
Heater Positive with Respect to Cathode	
DC .....	100 Volts
Total DC and Peak .....	300 Volts

**DIRECT INTERELECTRODE CAPACITANCES (Unshielded)**

Cathode to Plate and Heater .....	17.0 Pf
Plate to Cathode and Heater .....	13.0 Pf
Heater to Cathode .....	4.4 Pf

**RATINGS (Design Maximum Rating System)**

**Damper Service<sup>(1)</sup>**

Peak Inverse Plate Voltage (Max.) .....	5000 Volts
Plate Dissipation (Max.) .....	11 Watts
Steady State Peak Plate Current (Max.) .....	1500 Ma
DC Plate Current (Max.) .....	350 Ma

**CHARACTERISTICS AND TYPICAL OPERATION**

Tube Voltage Drop for I <sub>b</sub> = 680 Ma .....	20 Volts
---	----------

**NOTE:**

- (1) For operation in a 525 line, 30 frame system as described in "Standards of Good Engineering Practice for Television Broadcast Stations; Federal Communications Commission," the duty cycle of the voltage pulse must not exceed 15% of one horizontal scanning cycle.

**DAMPER**

**6CK3**  
12CK3, 17CK3, 25CK3

**Heater-Cathode Diode**

Construction .....Nova T-9  
 Base .....Nova Button 9 Pin, E9-89  
 (Exhaust Tip on Base)  
 Basing .....9HP  
 Outline  
 Maximum Diameter .....1.188 In.  
 Maximum Seated Height .....2.625 In.  
 Maximum Overall Height .....3.005 In.

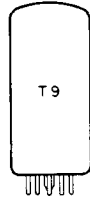
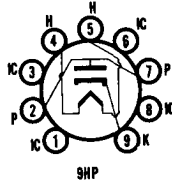

**ELECTRICAL DATA**

**HEATER OPERATION**

	<b>25CK3</b>	<b>17CK3</b>	<b>12CK3</b>	<b>6CK3</b>
Heater Voltage.....	25.2	16.8	12.6	6.3 Volts
Heater Current.....	300	450	600	1200 Ma
Heater Warm-up Time.....	11	11	11	— Seconds

Maximum Heater-Cathode Voltage  
 Heater Negative with Respect to Cathode

DC.....	900 Volts
Total DC and Peak.....	5200 Volts

Heater Positive with Respect to Cathode

DC.....	100 Volts
Total DC and Peak.....	300 Volts

**DIRECT INTERELECTRODE CAPACITANCES (Unshielded)**

Heater to Cathode.....	3.0 Pf
Plate to Cathode and Heater.....	6.5 Pf
Cathode to Plate and Heater.....	9.0 Pf

**RATINGS (Design Maximum Rating System)**

**Damper Service<sup>(1)</sup>**

Peak Inverse Plate Voltage (Max.).....	5200 Volts
Plate Dissipation (Max.).....	6.5 Watts
Steady State Peak Current (Max.).....	1200 Ma
DC Plate Current (Max.).....	250 Ma
Bulb Temperature at Hottest Point.....	220 °C

**CHARACTERISTICS AND TYPICAL OPERATION**

Tube Voltage Drop for $I_b = 350$ Ma.....	16 Volts
---	----------

**NOTE:**

(1) For operation in a 525 line, 30 frame system as described in "Standards of Good Engineering Practice for Television Broadcast Stations; Federal Communications Commission," the duty cycle of the voltage pulse must not exceed 15% of one horizontal scanning cycle.

*Color Television Type*  
**DAMPER**

**6CL3**  
12CL3, 17CL3

**Heater-Cathode Diode**

Construction .....Nova T-9  
 Base .....Nova Button 9 Pin, E9-89  
 (Exhaust Tip on Base)  
 Basing<sup>(1)</sup> .....9HP  
 Outline  
 Maximum Diameter .....1.188 In.  
 Maximum Seated Height .....2.625 In.  
 Maximum Overall Height .....3.005 In.

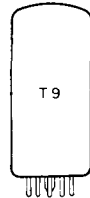
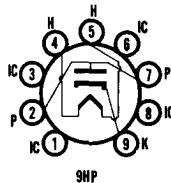

**ELECTRICAL DATA**

**HEATER OPERATION**

	<b>17CL3</b>	<b>12CL3</b>	<b>6CL3</b>
Heater Voltage.....	16.8	12.6	6.3 Volts
Heater Current.....	450	600	1200 Ma
Heater Warm-up Time.....	11	11	— Seconds

Maximum Heater-Cathode Voltage  
 Heater Negative with Respect to Cathode

DC.....	900 Volts
Total DC and Peak.....	5000 Volts

Heater Positive with Respect to Cathode	
DC .....	100 Volts
Total DC and Peak .....	300 Volts
<b>DIRECT INTERELECTRODE CAPACITANCES (Unshielded)</b>	
Heater to Cathode .....	3.0 Pf
Plate to Cathode and Heater .....	6.5 Pf
Cathode to Plate and Heater .....	9.0 Pf
<b>RATINGS (Design Maximum Rating System)</b>	
<b>Damper Service<sup>(2)</sup></b>	
Peak Inverse Plate Voltage (Max.) .....	5500 Volts
Plate Dissipation (Max.) .....	8.5 Watts
Steady State Peak Current (Max.) .....	1300 Ma
DC Plate Current (Max.) .....	250 Ma
Bulb Temperature at Hottest Point .....	220 °C
<b>CHARACTERISTICS AND TYPICAL OPERATION</b>	
Tube Voltage Drop for Ib = 350 Ma .....	16 Volts

**NOTES:**

- (1) Pins 1, 3, 6, and 8 should not be used as tie points.
- (2) For operation in a 525 line, 30 frame system as described in "Standards of Good Engineering Practice for Television Broadcast Stations; Federal Communications Commission," the duty cycle of the voltage pulse must not exceed 15% of one horizontal scanning cycle.



**Beam Pentode**

Construction .....	Miniature T-6½
Base .....	Button 9 Pin, E9-1
Basing .....	.9BV
Outline .....	6-3
Maximum Diameter .....	0.875 In.
Maximum Seated Height .....	2.375 In.
Maximum Overall Height .....	2.625 In.

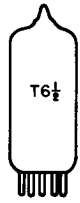
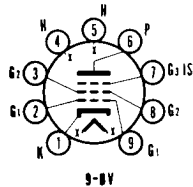

**ELECTRICAL DATA**

**HEATER OPERATION**

Heater Voltage .....	6.3 Volts
Heater Current .....	650 Ma
Maximum Heater-Cathode Voltage .....	100 Volts

**DIRECT INTERELECTRODE CAPACITANCES (Unshielded)**

Grid No. 1 to Plate .....	0.12 Pf
Input .....	11 Pf
Output .....	5.5 Pf

**RATINGS (Design Center Rating System)**

Plate Voltage (Max.) .....	300 Volts
Plate Dissipation (Max.) .....	7.5 Watts
Grid No. 2 Voltage (Max.) .....	150 Volts
Grid No. 2 Input (Max.) .....	1.7 Watts
Grid No. 3 Voltage (Max.) .....	0 Volt
Grid No. 1 Voltage .....	
Negative Bias Value (Max.) .....	50 Volts
Positive Bias Value (Max.) .....	0 Volt
Grid No. 1 Circuit Resistance .....	
Fixed Bias (Max.) .....	0.1 Megohm
Cathode Bias (Max.) .....	0.5 Megohm
Bulb Temperature (At Hottest Point) (Max.) .....	200° C

**CHARACTERISTICS AND TYPICAL OPERATION**

Plate Voltage .....	250 Volts
Grid No. 2 Voltage .....	150 Volts
Grid No. 3 Voltage .....	Connected to Cathode at Socket
Grid No. 1 Bias Voltage .....	-3 Volts
Peak AF Grid No. 1 Signal Voltage .....	3 Volts
Zero Signal DC Plate Current .....	30 Ma
Maximum Signal DC Plate Current .....	31 Ma
Zero Signal DC Grid No. 2 Current .....	7 Ma
Maximum Signal DC Grid No. 2 Current .....	7.2 Ma
Transconductance .....	11,000 μmhos
Plate Resistance (Approx.) .....	90,000 Ohms
Grid No. 1 Voltage for Plate Current of 10 μa (Approx.) .....	-14 Volts
Load Resistance .....	7500 Ohms

Total Harmonic Distortion .....	8 Percent
Maximum Signal Power Output.....	2.8 Watts
<b>4 MHz Bandwidth Video Amplifier</b>	
Plate Supply Voltage.....	300 Volts
Grid No. 3 Voltage.....	Connected to Cathode at Socket
Grid No. 2 Supply Voltage.....	300 Volts
Grid No. 1 Bias Voltage .....	-2 Volts
Peak-to-Peak Signal Voltage Grid No. 1 .....	3 Volts
Grid No. 2 Resistor .....	24,000 Ohms
Grid No. 1 Resistor .....	0.1 Megohm
Plate Load Resistor.....	3900 Ohms
Zero Signal Plate Current .....	30 Ma
Zero Signal Grid No. 2 Current .....	7.0 Ma
Peak-to-Peak Voltage Output .....	132 Volts

Color Television Type  
**VHF OSCILLATOR and MIXER**

**6CL8A**  
5CL8A, 19CL8A

**Medium Mu Triode and Semi-Remote Cutoff Tetrode**

Construction ..... Miniature T-6½  
 Base ..... Button 9 Pin, E9-1  
 Basing ..... 9FX  
 Outline ..... 6-2  
 Maximum Diameter ..... 0.875 In.  
 Maximum Seated Height ..... 1.937 In.  
 Maximum Overall Height ..... 2.187 In.

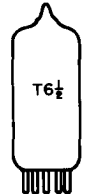
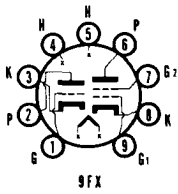

**ELECTRICAL DATA**

**HEATER OPERATION**

	19CL8A	5CL8A	6CL8A
Heater Voltage.....	18.9	4.7	6.3 Volts
Heater Current .....	150	600	450 Ma
Heater Warm-up Time .....	—	11	11 Seconds
Maximum Heater-Cathode Voltage			
Heater Negative with Respect to Cathode			
Total DC and Peak.....			200 Volts
Heater Positive with Respect to Cathode			
DC .....			100 Volts
Total DC and Peak.....			200 Volts

**DIRECT INTERELECTRODE CAPACITANCES**

	Shielded <sup>(1)</sup>	Unshielded
<b>Triode Section</b>		
Grid to Plate .....	1.8	1.8 Pf
Input: g to (h + k) .....	2.7	2.7 Pf
Output: p to (h + k) .....	1.2	0.4 Pf
<b>Tetrode Section</b>		
Grid No. 1 to Plate (Max.).....	0.010	0.020 Pf
Input: g1 to (h + k + g2).....	5.0	5.0 Pf
Output: p to (h + k + g2).....	3.4	2.4 Pf

**RATINGS (Design Center Rating System)**

	Triode Section	Tetrode Section
Plate Voltage (Max.) .....	300	300 Volts
Grid No. 2 Supply Voltage (Max) .....	—	300 Volts
Grid No. 2 Voltage .....	See Rating Chart (Gen. Info. Sec.)	
Plate Dissipation (Max.) .....	2.7	2.8 Watts
Grid No. 2 Dissipation (Max.) .....	—	0.5 Watts
Positive Grid No. 1 Voltage (Max.) .....	0	0 Volt
Grid No. 1 Circuit Resistance		
Fixed Bias (Max.) .....	0.5	0.25 Megohm
Self Bias (Max.) .....	1.0	1.0 Megohm

**CHARACTERISTICS AND TYPICAL OPERATION**

	Triode Section	Tetrode Section
<b>Class A1 Amplifier</b>		
Plate Voltage .....	125	125 Volts
Grid No. 2 Voltage .....	—	125 Volts

	Triode Section	Tetrode Section
Grid No. 1 Voltage .....	0	-1.0 Volt
Cathode Bias Resistor .....	56	— Ohms
Plate Current .....	15	12 Ma
Grid No. 2 Current .....	—	4.0 Ma
Transconductance .....	8000	6400 $\mu$ mhos
Amplification Factor .....	40	—
Plate Resistance .....	5000	100K Ohms
Grid No. 1 Voltage for $I_b = 10 \mu$ a (Approx.) .....	-9	-10 Volts

**NOTE:**

(1) Shield No. 315.

**6CM3**

25CM3, 34CM3

**DAMPER**

**Heater-Cathode Diode**

Construction .....Novar T-9  
 Base .....E9-89  
 Basing .....9HP  
 Outline  
 Maximum Diameter .....1.188 In.  
 Maximum Seated Height .....2.625 In.  
 Maximum Overall Height .....3.005 In.

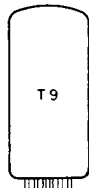
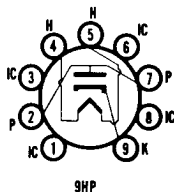

**ELECTRICAL DATA**  
**HEATER OPERATION**

	6CM3	25CM3	34CM3
Heater Voltage .....	6.3	25.0	33.5 Volts
Heater Current .....	2.4	0.600	0.450 Amp.
Heater Warm-up Time .....	—	11	11 Seconds
Maximum Heater-Cathode Voltage			
Heater Negative with Respect to Cathode			
DC .....			900 Volts
Total DC and Peak .....			5500 Volts
Heater Positive with Respect to Cathode			
DC .....			100 Volts
Total DC and Peak .....			300 Volts
<b>DIRECT INTERELECTRODE CAPACITANCES (Without Shield)</b>			
Cathode to Plate and Heater .....			18.0 pf
Plate to Cathode and Heater .....			20.0 pf
Heater to Cathode .....			4.0 pf

**RATINGS (Design Maximum Rating System)**

**Damper Service<sup>(1)</sup>**

Peak Inverse Plate Voltage (Max.) .....	5500 Volts
Plate Dissipation (Max.) .....	12 Watts
Steady State Peak Plate Current (Max.) .....	1700 Ma
DC Plate Current (Max.) .....	400 Ma

**AVERAGE CHARACTERISTICS**

Tube Voltage Drop ( $I_b = 350$ Ma) .....	10 Volts
---	----------

**NOTE:**

(1) For operation in a 525 line, 30 frame system as described in "Standards of Good Engineering Practice of Television Broadcasting Stations, Federal Communications Commission," the duty cycle of the voltage pulse is not to exceed 15% of one horizontal scanning cycle.

**6CM6**

5CM6, 12CM6

Color Television Type

**AUDIO POWER AMPLIFIER or**  
**VERTICAL DEFLECTION AMPLIFIER**

**Beam Power Pentode**

Construction .....Miniature T-6½  
 Base .....Button 9 Pin, E9-1  
 Basing .....9CK  
 Outline  
 Maximum Diameter .....0.875 In.  
 Maximum Seated Height .....2.375 In.  
 Maximum Overall Height .....2.625 In.

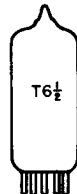
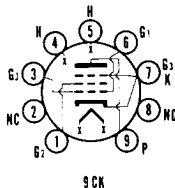

**ELECTRICAL DATA**

**HEATER OPERATION**

	12CM6	5CM6	6CM6
Heater Voltage.....	12.6	4.7	6.3 Volts
Heater Current.....	225	600	450 Ma
Heater Warm-up Time.....	—	11	— Seconds
Maximum Heater-Cathode Voltage			
Heater Negative with Respect to Cathode			
Total DC and Peak.....			200 Volts
Heater Positive with Respect to Cathode			
DC.....			100 Volts
Total DC and Peak.....			200 Volts

**DIRECT INTERELECTRODE CAPACITANCES (Unshielded)**

Grid to Plate.....	0.7 Pf
Input: g1 to (h + k + g2 + g3).....	8.0 Pf
Output: p to (h + k + g2 + g3).....	8.5 Pf

**RATINGS (Design Center Rating System)**

**Class A1 Amplifier**

Plate Voltage (Max.).....	315 Volts
Plate Dissipation (Max.).....	12 Watts
Grid No. 2 Voltage (Max.).....	285 Volts
Grid No. 2 Dissipation (Max.).....	2 Watts
Grid No. 1 Circuit Resistance	
Fixed Bias (Max.).....	0.1 Megohm
Cathode Bias (Max.).....	0.5 Megohm

**Vertical Deflection Amplifier<sup>(1)</sup>**

	Pent. Conn.	Tri. Conn.
Plate Voltage (Max.).....	315	315 Volts
Peak Positive Plate Voltage (Abs. Max.).....	2000	2000 Volts
Plate Dissipation (Max.) <sup>(2)</sup> .....	8	9 Watts
Grid No. 2 Voltage.....	285	— Volts
Grid No. 2 Dissipation <sup>(2)</sup> .....	1.75	— Watts
Peak Negative Grid Voltage (Max.).....	250	250 Volts
Average Cathode Current (Max.).....	40	40 Ma
Peak Cathode Current (Max.).....	120	120 Ma
Grid No. 1 Circuit Resistance		
Cathode Bias (Max.).....	2.2	2.2 Megohms

**CHARACTERISTICS AND TYPICAL OPERATION**

**Class A1 Amplifier**

	Tri. Conn.	Single Tube			Push-Pull	
Plate Voltage.....	250	180	250	315	250	285 Volts
Grid No. 2 Voltage.....	—	180	250	225	250	285 Volts
Grid No. 1 Voltage.....	-12.5	-8.5	-12.5	-13.0	-15	-19 Volts
Peak AF Grid No. 1 Voltage.....	—	8.5	12.5	13.0	30	38 Volts
Zero Signal Plate Current.....	49.5	29	45	34	70	70 Ma
Maximum Signal Plate Current.....	—	30	47	35	90	92 Ma
Zero Signal Grid No. 2 Current.....	—	3.0	4.5	2.2	5	4 Ma
Max. Signal Grid No. 2 Current.....	—	4.0	7.0	6.0	13	13.5 Ma
Plate Resistance (Approx.).....	1960	50,000	50,000	80,000	—	— Ohms
Transconductance.....	5000	3700	4100	3750	—	— $\mu$ mhos
Amplification Factor.....	9.8	—	—	—	—	—
Load Resistance.....	—	5500	5000	8500	10,000	8000 Ohms
Maximum Signal Power Output.....	—	2.0	4.5	5.5	10	14 Watts
Total Harmonic Distortion.....	—	8	8	12	5	3.5 Percent
E <sub>c1</sub> for I <sub>b</sub> = 0.5 Ma (Approx.).....	-37	—	-37	—	—	— Volts

**NOTES:**

- (1) For operation in a 525 line, 30 frame system as described in "Standards of Good Engineering Practice for Television Broadcast Stations; Federal Communications Commission," the duty cycle of the voltage pulse must not exceed 15% of one horizontal scanning cycle.
- (2) In stages operating with a grid-leak bias, an adequate cathode bias resistor, or other suitable means, is required to protect the tube in the absence of excitation.

**VERTICAL DEFLECTION OSCILLATOR and AMPLIFIER**

**6CM7**  
8CM7

**Dissimilar Double Triode**

Construction.....	Miniature T-6½
Base.....	Button 9 Pin, E9-1
Basing.....	.9ES
Outline.....	6-3
Maximum Diameter.....	0.875 In.
Maximum Seated Height.....	2.375 In.
Maximum Overall Height.....	2.625 In.

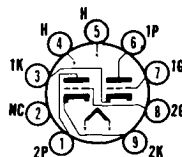

9ES

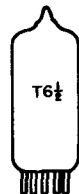

**ELECTRICAL DATA  
HEATER OPERATION**

	<b>8CM7</b>	<b>6CM7</b>
Heater Voltage.....	8.4	6.3 Volts
Heater Current .....	450	600 Ma
Heater Warm-up Time .....	11	11 Seconds
Maximum Heater-Cathode Voltage		
Heater Negative with Respect to Cathode		
Total DC and Peak.....		200 Volts
Heater Positive with Respect to Cathode		
DC .....		100 Volts
Total DC and Peak.....		200 Volts

**DIRECT INTERELECTRODE CAPACITANCES (Unshielded)**

	<b>Section 1<sup>(1)</sup></b>	<b>Section 2</b>
Grid to Plate .....	3.8	3.0 Pf
Input: g to (k + h) .....	2.0	3.5 Pf
Output: p to (k + h) .....	0.5	0.4 Pf

**RATINGS (Design Center Rating System)**

**Vertical Deflection Oscillator and Amplifier<sup>(2)</sup>**

	<b>Section 1<sup>(1)</sup> (Oscillator)</b>	<b>Section 2 (Amplifier)</b>
DC Plate Voltage (Max.) .....	500	500 Volts
Peak Positive Pulse Plate Voltage (Abs. Max.) .....	—	2200 Volts
Plate Dissipation (Max.) <sup>(3)</sup> .....	1.25	5.5 Watts
Peak Negative Pulse Grid Voltage (Max.) .....	200	200 Volts
Average Cathode Current (Max.) .....	15	20 Ma
Peak Cathode Current (Max.).....	70	70 Ma
Grid Circuit Resistance		
Fixed Bias (Max.) .....	2.2	1.0 Megohms
Cathode Bias (Max.) .....	2.2	2.5 Megohms

**CHARACTERISTICS AND TYPICAL OPERATION**

	<b>Section 1<sup>(1)</sup> (Oscillator)</b>	<b>Section 2 (Amplifier)</b>
Plate Voltage .....	200	250 Volts
Grid Voltage .....	-7	-8 Volts
Plate Current .....	5	20 Ma
Transconductance .....	2000	4400 $\mu$ mhos
Amplification Factor .....	21	18
Plate Resistance.....	10,500	4100 Ohms
Plate Current at $E_c = -10$ Volts .....	1.0	— Ma
Grid Voltage for $I_b = 10 \mu$ a .....	-14	— Volts

**NOTES:**

- (1) Section 1 connects to pins 3, 6, and 7. Section 2 connects to pins 1, 8, and 9.
- (2) For operation in a 525 line, 30 frame system as described in "Standards of Good Engineering Practice for Television Broadcast Stations; Federal Communications Commission," the duty cycle of the voltage pulse must not exceed 15% of one horizontal scanning cycle.
- (3) In stages operating with grid leak bias, an adequate cathode bias resistor or other suitable means is required to protect the tube in the absence of excitation.

6CM8

5CM8

GENERAL PURPOSE AMPLIFIER (T)  
IF/VIDEO/AGC AMPLIFIER (P)

**High Mu Triode and Sharp Cutoff Pentode**

Construction .....	Miniature T-6½
Base .....	Button 9 Pin, E9-1
Basing .....	.9FZ
Outline .....	6-2
Maximum Diameter .....	0.875 In.
Maximum Seated Height .....	1.937 In.
Maximum Overall Height .....	2.187 In.

**ELECTRICAL DATA  
HEATER OPERATION**

	<b>5CM8</b>	<b>6CM8</b>
Heater Voltage.....	4.7	6.3 Volts
Heater Current .....	600	450 Ma
Heater Warm-up Time .....	11	11 Seconds

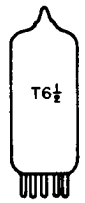
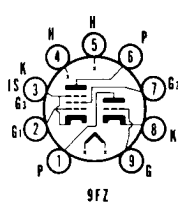



Maximum Heater-Cathode Voltage	
Heater Negative with Respect to Cathode	
Total DC and Peak.....	200 Volts
Heater Positive with Respect to Cathode	
DC .....	100 Volts
Total DC and Peak.....	200 Volts

**DIRECT INTERELECTRODE CAPACITANCES (Unshielded)**

**Triode Section**

Grid to Plate .....	1.9 Pf
Input: g to (h + k) .....	1.6 Pf
Output: p to (h + k) .....	0.22 Pf

**Pentode Section**

Grid No. 1 to Plate (Max.).....	0.04 Pf
Input: g1 to (h + k + g2 + g3 + IS).....	6.0 Pf
Output: p to (h + k + g2 + g3 + IS).....	2.6 Pf

**Coupling**

Pentode Plate to Triode Grid (Max.) .....	0.01 Pf
Pentode Grid No. 1 to Triode Plate (Max.) .....	0.15 Pf
Pentode Plate to Triode Plate (Max.) .....	0.10 Pf

**RATINGS (Design Center Rating System)**

	Triode	Pentode
Plate Voltage (Max.) .....	300	300 Volts
Grid No. 2 Supply Voltage (Max.) .....	—	300 Volts
Grid No. 2 Voltage .....	See Rating Chart (Gen. Info. Sec.)	
Positive Grid No. 1 Voltage (Max.) .....	0	0 Volt
Plate Dissipation (Max.) .....	1.0	2.0 Watts
Grid No. 2 Dissipation (Max.) .....	—	0.5 Watt
Grid No. 1 Circuit Resistance		
Self Bias (Max.) .....	—	1.0 Megohm
Fixed Bias (Max.) .....	—	0.25 Megohm

**CHARACTERISTICS AND TYPICAL OPERATION**

**Class A1 Amplifier**

	Triode	Pentode
Plate Supply Voltage.....	250	200 Volts
Grid No. 2 Voltage .....	—	150 Volts
Grid No. 1 Voltage .....	-2	0 Volts
Cathode Bias Resistor .....	—	180 Ohms
Plate Current .....	1.8	9.5 Ma
Grid No. 2 Current .....	—	2.8 Ma
Amplification Factor .....	100	—
Plate Resistance (Approx.) .....	50,000	600,000 Ohms
Transconductance .....	2000	6200 $\mu$ mhos
Grid No. 1 Voltage for Ib = 10 $\mu$ a (Approx.) .....	—	-8 Volts

Color Television Type

**REACTANCE TUBE or SYNC  
SEP/AMP (T); PHASE DETECTOR (D)**

**6CN7**

8CN7

**Double Diode and High Mu Triode**

Construction .....	Miniature T-6½
Base .....	Button 9 Pin, E9-1
Basing .....	9EN
Outline .....	6-2
Maximum Diameter .....	0.875 In.
Maximum Seated Height .....	1.937 In.
Maximum Overall Height .....	2.187 In.

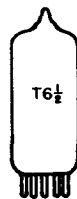
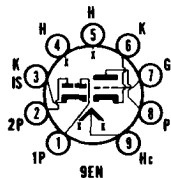

**ELECTRICAL DATA  
HEATER OPERATION**

	8CN7	6CN7
Heater Voltage Series/Parallel.....	8.4/4.2	6.3/3.15 Volts
Heater Current .....	225/450	300/600 Ma
Heater Warm-up Time .....	11	11 Seconds
Maximum Heater-Cathode Voltage		
Heater Negative with Respect to Cathode		
Total DC and Peak.....		200 Volts
Heater Positive with Respect to Cathode		
DC .....		100 Volts
Total DC and Peak.....		200 Volts

**DIRECT INTERELECTRODE CAPACITANCES (Unshielded)**

Triode Grid to Plate.....	1.8 Pf
Triode Input .....	1.5 Pf
Triode Output.....	0.5 Pf
Grid to Each Diode Plate.....	0.006 Pf
Diode p1 to (dk + h) .....	3.6 Pf
Diode p2 to (dk + h) .....	3.6 Pf

**RATINGS (Design Maximum Rating System)**

Plate Voltage (Max.) .....	330 Volts
Positive DC Grid Voltage (Max.) .....	0 Volt
Plate Dissipation (Max.) .....	1.1 Watt
Diode Current for Continuous Operation Each Diode (Max.) .....	5.5 Ma

**CHARACTERISTICS AND TYPICAL OPERATION**

**Class A1 Amplifier**

Plate Voltage .....	100	250 Volts
Grid Voltage .....	-1.0	-3.0 Volts
Amplification Factor .....	70	70
Plate Resistance (Approx.) .....	54,000	58,000 Ohms
Transconductance .....	1300	1200 $\mu$ mhos
Plate Current .....	0.8	1.0 Ma
Average Diode Current, Each Diode with 5.0 Volts DC Applied .....	—	20 Ma



**Medium Mu Triode and Sharp Cutoff Tetrode**

Construction .....	Miniature T-6 $\frac{1}{2}$
Base .....	Button 9 Pin, E9-1
Basing .....	9GE
Outline .....	6-2
Maximum Diameter .....	0.875 In.
Maximum Seated Height .....	1.937 In.
Maximum Overall Height .....	2.187 In.

**ELECTRICAL DATA  
HEATER OPERATION**

	5CQ8	6CQ8
Heater Voltage.....	4.7	6.3 Volts
Heater Current .....	600	450 Ma
Heater Warm-up Time .....	11	11 Seconds
Maximum Heater Cathode Voltage Heater Negative with Respect to Cathode Total DC and Peak.....		200 Volts
Heater Positive with Respect to Cathode DC .....		100 Volts
Total DC and Peak.....		200 Volts

**DIRECT INTERELECTRODE CAPACITANCES**

**Triode Section**

	Shielded <sup>(1)</sup>	Unshielded
Grid to Plate .....	1.8	1.8 Pf
Input: g to (h + k) .....	2.7	2.7 Pf
Output: p to (h + k) .....	0.4	1.2 Pf

**Pentode Section**

Grid No. 1 to Plate (Max.).....	0.019	0.015 Pf
Input: g1 to (h + k + g2 + IS) .....	5	5 Pf
Output: p to (h + k + g2 + IS) .....	2.5	3.3 Pf

**Coupling**

Triode Plate to Tetrode Plate (Max.).....	0.07	0.01 Pf
---	------	---------

**RATINGS (Design Maximum Rating System)**

	Triode Section (Oscillator)	Tetrode Section (Mixer)
Plate Voltage (Max.) .....	330	330 Volts
Grid No. 2 Voltage .....	See Rating Chart (Gen. Info. Sec.)	
Grid No. 2 Supply Voltage (Max.) .....	—	330 Volts
Positive Grid Voltage (Max.) .....	0	0 Volt
Plate Dissipation (Max.) .....	3.1	3.2 Watts

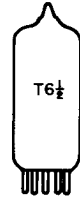
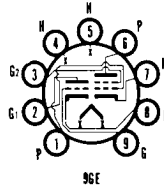

Grid No. 2 Input (Up to 150 Volts) (Max.) .....	—	0.7 Watt
Grid No. 2 Input (150 Volts to 300 Volts) (Max.) . See Rating Chart (Gen. Info. Sec.)		
Grid Input .....	0.55	— Watt
Grid Circuit Resistance		
Fixed Bias (Max.) .....	0.5	0.25 Megohm
Cathode Bias (Max.) .....	1.0	1.0 Megohm

**CHARACTERISTICS AND TYPICAL OPERATION**

**Class A1 Amplifier**

	<b>Triode Section</b>	<b>Tetrode Section</b>
Plate Voltage .....	125	125 Volts
Grid No. 2 Voltage .....	—	125 Volts
Grid No. 1 Voltage .....	—	-1.0 Volt
Cathode Resistor .....	56	— Ohms
Plate Current .....	15	12 Ma
Grid No. 2 Current .....	—	4.2 Ma
Transconductance .....	8000	5800 $\mu$ mhos
Amplification Factor .....	40	—
Plate Resistance (Approx.) .....	5000	140,000 Ohms
Ecl for Ib = 100 $\mu$ a (Approx.).....	-7	-7 Volts

**NOTE:**

(1) With external JEDEC No. 315 shield connected to cathode of section under test.

*Color Television Type*

**SYNC SEPARATOR and CLIPPER**

**6CS6**

3CS6, 4CS6, 12CS6

**Dual Control Heptode**

Construction .....	Miniature T-5 $\frac{1}{2}$
Base .....	Button 7 Pin, E7-1
Basing .....	7CH
Outline .....	5-2
Maximum Diameter .....	0.750 In.
Maximum Seated Height .....	1.875 In.
Maximum Overall Height .....	2.125 In.

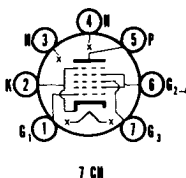

**ELECTRICAL DATA**

**HEATER OPERATION**

	<b>12CS6</b>	<b>4CS6</b>	<b>3CS6</b>	<b>6CS6</b>
Heater Voltage.....	12.6	4.2	3.15	6.3 Volts
Heater Current .....	150	450	600	300 Ma
Heater Warm-up Time .....	—	11	11	— Seconds
Maximum Heater-Cathode Voltage				
Heater Negative with Respect to Cathode				
Total DC and Peak.....				200 Volts
Heater Positive with Respect to Cathode				
DC .....				100 Volts
Total DC and Peak.....				200 Volts

**DIRECT INTERELECTRODE CAPACITANCES (Unshielded)**

Grid No. 1 to Plate (Max.).....	0.05 Pf
Grid No. 3 to Plate (Max.).....	0.36 Pf
Grid No. 1 Input: g1 to (k + h + g2 + g3 + g5) .....	5.5 Pf
Grid No. 3 Input: g3 to (k + h + g1 + g2 + g5) .....	7.0 Pf
Output: p to (k + h + g1 + g2 + g3 + g5) .....	7.5 Pf
Coupling (g1 to g3) (Max.) .....	0.15 Pf

**RATINGS (Design Center Rating System)**

Plate Voltage (Max.) .....	300 Volts
Plate Dissipation (Max.) .....	1.0 Watt
Grid No. 2 Voltage (Max.) .....	100 Volts
Grid No. 2 Supply Voltage (Max.) .....	300 Volts
Grid No. 2 Dissipation (Max.) .....	1.0 Watt
Cathode Current (Max.).....	14 Ma
Grid No. 1 Circuit Resistance (Max.).....	0.47 Megohm
Grid No. 3 Circuit Resistance (Max.).....	2.2 Megohms

**CHARACTERISTICS AND TYPICAL OPERATION**

Plate Voltage .....	10	100	100 Volts
Grid No. 2 Voltage .....	30	30	30 Volts

Grid No. 1 Voltage .....	0	0	-1.0 Volt
Grid No. 3 Voltage .....	0	-1.0	0 Volt
Plate Current .....	1.2	0.8	0.75 Ma
Grid No. 2 Current .....	4.1	4.0	1.1 Ma
Transconductance			
Grid No. 1.....	—	—	950 $\mu$ mhos
Grid No. 3.....	—	1250	— $\mu$ mhos
Plate Resistance (Approx.) .....	—	0.7	1.0 Megohm
Grid Voltage for $I_b = 50 \mu$ a			
Grid No. 1.....	—	—	-2.5 Volts
Grid No. 3.....	—	-2.2	— Volts

**6CS7**  
8CS7

**VERTICAL DEFLECTION  
OSCILLATOR and AMPLIFIER**

**Double Dissimilar Triode**

Construction ..... Miniature T-6½  
 Base ..... Button 9 Pin, E9-1  
 Basing ..... 9EF  
 Outline ..... 6-3  
   Maximum Diameter ..... 0.875 In.  
   Maximum Seated Height ..... 2.375 In.  
   Maximum Overall Height ..... 2.625 In.

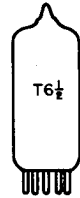
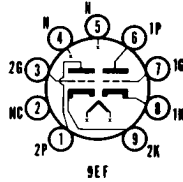

**ELECTRICAL DATA**

**HEATER OPERATION**

	<b>8CS7</b>	<b>6CS7</b>
Heater Voltage.....	8.4	6.3 Volts
Heater Current .....	450	600 Ma
Heater Warm-up Time .....	11	11 Seconds
Maximum Heater-Cathode Voltage		
Heater Negative with Respect to Cathode		
Total DC and Peak.....		200 Volts
Heater Positive with Respect to Cathode		
DC .....		100 Volts
Total DC and Peak.....		200 Volts

**DIRECT INTERELECTRODE CAPACITANCES (Unshielded)**

	<b>Section 1<sup>(1)</sup></b>	<b>Section 2</b>
Grid to Plate .....	2.6	2.6 Pf
Input: g to (k + h + IS) .....	1.8	3.0 Pf
Output: p to (k + h + IS) .....	0.5	0.5 Pf

**RATINGS (Design Center Rating System)**

**Vertical Deflection Oscillator and Amplifier<sup>(2)</sup>**

	<b>Section 1<sup>(1)</sup> (Oscillator)</b>	<b>Section 2 (Amplifier)</b>
DC Plate Voltage (Max.) .....	500	500 Volts
Peak Positive Pulse Plate Voltage (Abs. Max.).....	—	2200 Volts
Plate Dissipation (Max.) <sup>(2)</sup> .....	1.25	6.5 Watts
Peak Negative Pulse Grid Voltage (Max.) .....	400	250 Volts
Average Cathode Current (Max.).....	20	30 Ma
Peak Cathode Current (Max.) .....	70	105 Ma
Grid Circuit Resistance (Max.).....	2.2	2.2 Megohms

**CHARACTERISTICS AND TYPICAL OPERATION**

	<b>Section 1<sup>(1)</sup></b>	<b>Section 2</b>
Plate Voltage .....	250	250 Volts
Grid Voltage .....	-8.5	-10.5 Volts
Plate Current .....	10.5	19.0 Ma

Transconductance .....	2200	4500 $\mu$ mhos
Amplification Factor .....	17.0	15.5
Plate Resistance.....	7700	3450 Ohms
Plate Current at $E_c = -16$ Volts .....	—	3.0 Ma
Grid Voltage for $I_b = 10 \mu$ a.....	-24	— Volts
Grid Voltage for $I_b = 50 \mu$ a.....	—	-22 Volts

**NOTES:**

- (1) Section 1 connects to Pins 6, 7, and 8. Section 2 connects to Pins 1, 3, and 9.
- (2) For operation in a 525 line, 30 frame system as described in "Standards of Good Engineering Practice for Television Broadcast Stations; Federal Communications Commission," the duty cycle of the voltage pulse must not exceed 15% of one horizontal scanning cycle.
- (3) In stages operating with grid leak bias, an adequate cathode bias resistor or other suitable means is required to protect the tube in the absence of excitation.

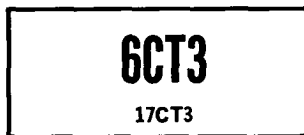

**Heater-Cathode Diode**

Construction .....	Miniature T-6½
Base .....	E9-1
Basing <sup>(1)</sup> .....	9RX
<b>Outline</b>	
Maximum Diameter .....	0.875 In.
Maximum Seated Height .....	2.875 In.
Maximum Overall Height .....	3.125 In.

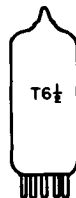
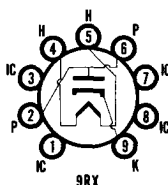

**ELECTRICAL DATA**

**HEATER OPERATION**

	6CT3	17CT3
Heater Voltage.....	6.3	16.8 Volts
Heater Current .....	1200	450 Ma
Heater Warm-up Time .....	—	11 Seconds
<b>Maximum Heater-Cathode Voltage</b>		
Heater Negative with Respect to Cathode		
DC .....		900 Volts
Total DC and Peak .....		5000 Volts
Heater Positive with Respect to Cathode		
DC .....		100 Volts
Total DC and Peak .....		300 Volts

**DIRECT INTERELECTRODE CAPACITANCES (Without Shield)**

Cathode to Plate and Heater.....	9.5 pf
Plate to Cathode and Heater.....	12.0 pf
Heater to Cathode .....	2.8 pf

**RATINGS (Design Maximum Rating System)**

**Damper Service<sup>(1)</sup>**

Peak Inverse Plate Voltage .....	5000 Volts
Plate Dissipation .....	4.75 Watts
Steady State Peak Plate Current .....	1200 Ma
DC Plate Current .....	250 Ma

**AVERAGE CHARACTERISTICS**

Tube Voltage Drop ( $I_b = 350$ Ma) .....	16 Volts
---	----------

**NOTES:**

- (1) For operation in a 525-line, 30-frame system as described in "Standards of Good Engineering Practice for Television Broadcasting Stations, Federal Communications Commission," the duty cycle of the voltage pulse is not to exceed 15% of a scanning cycle.
- (2) Pins designated Internal Connection (IC) may or may not connect to internal elements depending on the manufacturer. To maintain interchangeability do not use these pins for external connection.

**6CU5**  
**12C5/12CU5,**  
**17C5/17CU5, 25C5, 50C5**

*Color Television Type*  
**AUDIO POWER AMPLIFIER**

**Beam Pentode**

Construction ..... Miniature T-5½  
 Base ..... Button 7 Pin, E7-1  
 Basing ..... 7CV  
 Outline ..... 5-3  
 Maximum Diameter ..... 0.750 In.  
 Maximum Seated Height ..... 2.375 In.  
 Maximum Overall Height ..... 2.625 In.

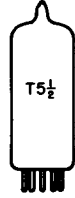
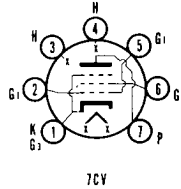

**ELECTRICAL DATA**  
**HEATER OPERATION**

	50C5	25C5	17C5/17CU5	12C5/12CU5
Heater Voltage.....	50	25	16.8	12.6
Heater Current .....	150	300	450	600
Heater Warm-up Time ..	—	—	11	11

**6CU5**  
 6.3 Volts  
 1200 Ma  
 — Seconds

**Maximum Heater-Cathode Voltage**

Heater Negative with Respect to Cathode

Total DC and Peak.....

200 Volts

Heater Positive with Respect to Cathode

DC .....

100 Volts

Total DC and Peak.....

200 Volts

**DIRECT INTERELECTRODE CAPACITANCES (Unshielded)**

Grid to Plate .....

0.6 Pf

Input .....

13 Pf

Output .....

8.5 Pf

**RATINGS (Design Maximum Rating System)**

Plate Voltage (Max.) .....

150 Volts

Grid No. 2 Voltage (Max.) .....

130 Volts

Plate Dissipation (Max.) .....

7.0 Watts

Grid No. 2 Dissipation (Max.) .....

1.4 Watts

Positive Grid No. 1 Voltage (Max.) .....

0 Volt

Grid No. 1 Circuit Resistance

Fixed Bias (Max.) .....

0.1 Megohm

Cathode Bias (Max.) .....

0.5 Megohm

Bulb Temperature (Hottest Point) (Max.).....

220 °C

**CHARACTERISTICS AND TYPICAL OPERATION**

**Class A1 Amplifier**

Plate Voltage .....

120 Volts

Grid No. 2 Voltage .....

110 Volts

Grid No. 1 Voltage .....

-8 Volts

Peak AF Grid No. 1 Voltage .....

8 Volts

Zero-Signal Plate Current.....

49 Ma

Maximum-Signal Plate Current .....

50 Ma

Zero-Signal Grid No. 2 Current.....

4.0 Ma

Maximum-Signal Grid No. 2 Current .....

8.5 Ma

Transconductance .....

7500 μmhos

Plate Resistance (Approx.) .....

10,000 Ohms

Load Resistance .....

2500 Ohms

Maximum-Signal Power Output.....

2.3 Watts

Total Harmonic Distortion (Approx.).....

10 Percent

**6CU8**

**IF/VIDEO/AGC AMP. (T)**  
**OSC./SYNC SEP. or CLIPPER (P)**

**Medium Mu Triode**  
**and Sharp Cutoff Pentode**

Construction ..... Miniature T-6½  
 Base ..... Button 9 Pin, E9-1  
 Basing ..... 9GM  
 Outline ..... 6-2  
 Maximum Diameter ..... 0.875 In.  
 Maximum Seated Height ..... 1.937 In.  
 Maximum Overall Height ..... 2.187 In.

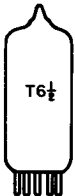
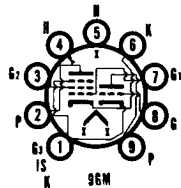

**ELECTRICAL DATA**

**HEATER OPERATION**

Heater Voltage.....	6.3 Volts
Heater Current.....	450 Ma
Heater Warm-up Time.....	11 Seconds
Maximum Heater-Cathode Voltage	
Heater Negative with Respect to Cathode	
Total DC and Peak.....	200 Volts
Heater Positive with Respect to Cathode	
DC.....	100 Volts
Total DC and Peak.....	200 Volts

**DIRECT INTERELECTRODE CAPACITANCES (Unshielded)**

**Triode Section**

Grid to Plate.....	1.6 Pf
Grid to (k + h + g3 + IS).....	1.9 Pf
Plate to (k + h + g3 + IS).....	1.6 Pf

**Pentode Section**

Grid No. 1 to Plate (Max.).....	0.025 Pf
Grid No. 1 to (k and g3 + g2 + h + Tk + IS).....	7.0 Pf
Plate to (k and g3 + g2 + h + Tk + IS).....	2.4 Pf

**Coupling**

Pentode Grid No. 1 to Triode Plate (Max.).....	0.03 Pf
Pentode Plate to Triode Plate (Max.).....	0.07 Pf

**RATINGS (Design Center Rating System)**

	<b>Triode Section</b>	<b>Pentode Section</b>
Plate Voltage (Max.).....	330	330 Volts
Grid No. 2 Supply Voltage (Max.).....	—	330 Volts
Grid No. 2 Voltage.....	See Rating Chart (Gen. Info. Sec.)	
Plate Dissipation (Max.).....	2.8	2.3 Watts
Positive Grid No. 1 Voltage (Max.).....	0	0 Volt
Grid No. 2 Input:		
For Grid No. 2 Voltages Up to 150 Volts (Max.).....	—	0.55 Watt
For Grid No. 2 Voltages Between		
150 Volts and 300 Volts.....	See Rating Chart (Gen. Info. Sec.)	
Grid No. 1 Circuit Resistance		
Fixed Bias (Max.).....	0.5	0.25 Megohm
Self Bias (Max.).....	1.0	1.0 Megohm

**CHARACTERISTICS AND TYPICAL OPERATION**

	<b>Triode Section</b>	<b>Pentode Section</b>
Plate Voltage.....	125	125 Volts
Grid No. 2 Voltage.....	—	125 Volts
Grid Voltage.....	-1.0	— Volt
Cathode Bias Resistor.....	—	56 Ohms
Plate Current.....	17	12 Ma
Grid No. 2 Current.....	—	3.8 Ma
Transconductance.....	5800	7800 $\mu$ mhos
Amplification Factor.....	24	—
Plate Resistance.....	4100	170,000 Ohms
Ec1 for Ib = 10 $\mu$ a (Approx.).....	-12	-6 Volts
Ib at Ec1 = -3 Volts, RK = 0.....	—	1.6 Ma

Color Television Type  
**VHF AMPLIFIER**

**6CW4**  
2CW4, 13CW4

**High Mu Triode**

Construction.....Nuvistor, Metal  
 Base.....Medium Ceramic Wafer  
                     Twelvevar 5 Pin, E5-65  
 Basing.....12AQ  
 Outline

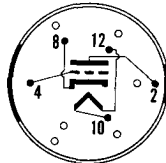

Maximum Diameter.....0.440 In.  
 Maximum Seated Height.....0.625 In.  
 Maximum Overall Height.....0.800 In.

**ELECTRICAL DATA**

**HEATER OPERATION**

	<b>12AQ</b>	<b>13CW4</b>	<b>2CW4</b>	<b>6CW4</b>
Heater Voltage.....		13.5	2.0	6.3 Volts
Heater Current.....		60	450	130 Ma

Heater Warm-up Time .....	—	11	— Seconds
Maximum Heater-Cathode Voltage .....			100 Volts
<b>DIRECT INTERELECTRODE CAPACITANCES (Shielded)</b>			
Grid to Plate .....			0.92 Pf
Input: g to (h + k + Shell) .....			4.3 Pf
Output: p to (h + k + Shell) .....			1.8 Pf
Heater to Cathode .....			1.3 Pf
Plate to Cathode .....			0.18 Pf
<b>RATINGS (Design Maximum Rating System)</b>			
Plate Supply Voltage (Max.) .....			300 Volts
Plate Voltage (Max.) .....			135 Volts
Plate Dissipation (Max.) .....			1.0 Watt
DC Cathode Current (Max.) .....			15 Ma
Negative Grid Voltage (Max.) .....			55 Volts
Grid Circuit Resistance			
Self Bias (Max.) .....			2.2 Megohms
Fixed Bias (Max.) .....			0.5 Megohms

**CHARACTERISTICS AND TYPICAL OPERATION**

**Class A1 Amplifier**

Plate Voltage .....	70	110 Volts
Grid Resistor .....	47,000	— Ohms
Cathode Resistor .....	—	130 Ohms
Plate Current .....	7.2	7 Ma
Transconductance .....	12,500	9800 $\mu$ mhos
Amplification Factor .....	68	65
Plate Resistance (Approx.) .....	5440	6600 Ohms
Ec for Ib = 10 $\mu$ a (Approx.) .....	—	—4 Volts

**6CW5/EL86**  
8CW5A, 10CW5/LL86  
15CW5/PL84, 30CW5

Color Television Type  
**AUDIO POWER AMPLIFIER**

**Beam Pentode**

Construction .....	Miniature T-6½
Base .....	Button 9 Pin, E9-1
Basing .....	9CV
Outline .....	6-4
Maximum Diameter .....	0.875 In.
Maximum Seated Height .....	2.813 In.
Maximum Overall Height .....	3.063 In.

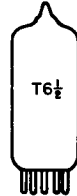
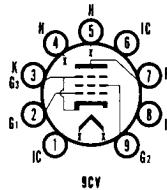

**ELECTRICAL DATA**

**HEATER OPERATION**

	30CW5	15CW5/ PL84	10CW5/ LL86	8CW5A	6CW5/EL86
Heater Voltage .....	30	15	10.6	8.0	6.3 Volts
Heater Current .....	150	300	450	600	760 Ma
Heater Warm-up Time .....	—	—	11	11	— Seconds

**Maximum Heater-Cathode Voltage**

Heater Negative with Respect to Cathode	
DC .....	220 Volts
Total DC and Peak .....	330 Volts

Heater Positive with Respect to Cathode	
DC .....	220 Volts
Total DC and Peak .....	330 Volts

**DIRECT INTERELECTRODE CAPACITANCES**

Grid No. 1 to All Other Electrodes Except Plate .....	1.3 Pf
Plate to All Other Electrodes Except Grid No. 1 .....	6.8 Pf
Plate to Grid No. 1 (Max.) .....	0.6 Pf
Grid No. 1 to Heater (Max.) .....	0.25 Pf

**RATINGS (Design Maximum Rating System)**

**Class A1 Amplifier**

Plate Voltage (Max.) .....	275 Volts
Grid No. 2 Voltage (Max.) .....	220 Volts
Plate Dissipation (Max.) .....	14 Watts
Grid No. 2 Dissipation (Max.) .....	2.1 Watts
Grid No. 1 Circuit Resistance	
Fixed Bias (Max.) .....	0.1 Megohm

**Vertical Deflection Amplifier (1)—Triode Connected (2)**

Plate Voltage (Max.) .....	275 Volts
Peak Positive Plate Voltage (Abs. Max.) .....	2200 Volts



Plate Dissipation (Max.) <sup>(3)</sup> .....	12 Watts
Peak Negative Grid No. 1 Voltage (Max.) .....	250 Volts
Average Cathode Current (Max.) .....	110 Ma
Peak Cathode Current (Max.) .....	240 Ma
Grid No. 1 Circuit Resistance .....	
Cathode Bias (Max.) .....	2.2 Megohms

**CHARACTERISTICS AND TYPICAL OPERATION**

Plate Voltage .....	170 Volts
Grid No. 2 Voltage .....	170 Volts
Grid No. 1 Voltage .....	-12.5 Volts
Plate Current .....	70 Ma
Grid No. 2 Current .....	3.5 Ma
Transconductance .....	11,000 $\mu$ mhos
Amplification Factor (g <sub>1</sub> to g <sub>2</sub> ) .....	8
Plate Resistance .....	26,000 Ohms

**NOTES:**

- (1) For operation in a 525 line, 30 frame system as described in "Standards of Good Engineering Practice for Television Broadcast Stations; Federal Communications Commission," the duty cycle of the voltage pulse must not exceed 15% of one horizontal scanning cycle.
- (2) Grid No. 2 connected to plate.
- (3) In stages operating with grid leak bias, an adequate cathode bias resistor or other suitable means is required to protect the tube in the absence of excitation.

**LOW FREQUENCY OSC. or AMP. (T)  
VIDEO AMPLIFIER (P)**

**6CX8**  
8CX8

**Medium Mu Triode and Sharp Cutoff Pentode**

Construction .....	Miniature T-6 $\frac{1}{2}$
Base .....	Button 9 Pin, E9-1
Basing .....	.9DX
Outline .....	.6-3
Maximum Diameter .....	.0.875 In.
Maximum Seated Height .....	.2.375 In.
Maximum Overall Height .....	.2.625 In.

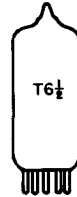
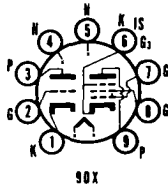

**ELECTRICAL DATA**

**HEATER OPERATION**

	8CX8	6CX8
Heater Voltage .....	8.0	6.3 Volts
Heater Current .....	600	750 Ma
Heater Warm-up Time .....	11	— Seconds
Maximum Heater-Cathode Voltage		
Heater Negative with Respect to Cathode		
Total DC and Peak .....		200 Volts
Heater Positive with Respect to Cathode		
DC .....		100 Volts
Total DC and Peak .....		200 Volts

**DIRECT INTERELECTRODE CAPACITANCES (Unshielded)**

**Triode Section**

Grid to Plate .....	4.4 Pf
Input .....	2.2 Pf
Output .....	0.38 Pf

**Pentode Section**

Grid No. 1 to Plate .....	0.06 Pf
Input .....	9.0 Pf
Output .....	4.4 Pf

**Coupling**

Pentode Grid No. 1 to Triode Plate (Max.) .....	0.005 Pf
Pentode Plate to Triode Grid (Max.) .....	0.018 Pf
Pentode Plate to Triode Plate (Max.) .....	0.17 Pf

**RATINGS (Design Maximum Rating System)**

	Triode Section	Pentode Section
Plate Voltage (Max.) .....	330	330 Volts
Grid No. 2 Supply Voltage (Max.) .....	—	330 Volts

Grid No. 2 Voltage .....	See Rating Chart (Gen. Info. Sec.)	
Positive Grid No. 1 Voltage (Max.) .....	0	0 Volt
Plate Dissipation (Max.) .....	2.0	5.0 Watts
Grid No. 2 Dissipation (Max.) .....	—	1.1 Watts
Grid No. 1 Circuit Resistance		
Fixed Bias (Max.) .....	0.5	0.25 Megohm
Cathode Bias (Max.) .....	1.0	1.0 Megohm

**CHARACTERISTICS AND TYPICAL OPERATION**

**Class A1 Amplifier**

	<b>Triode Section</b>	<b>Pentode Section</b>
Plate Voltage .....	150	200 Volts
Grid No. 2 Voltage .....	—	125 Volts
Cathode Bias Resistor .....	150	68 Ohms
Plate Current .....	9.2	24 Ma
Grid No. 2 Current .....	—	5.2 Ma
Transconductance .....	4600	10,000 $\mu$ mhos
Amplification Factor .....	40	—
Plate Resistance (Approx.) .....	8700	70,000 Ohms
Grid No. 1 Voltage for $I_b = 100 \mu a$ (Approx.) .....	-5.0	-8.5 Volts

**INSTANTANEOUS PLATE KNEE CHARACTERISTICS**

$E_b = 40 V, E_{c2} = 125 V, E_{c1} = 0 V$   
 $I_b = 40 Ma, I_{c2} = 15.5 Ma$

# 6CY5

2CY5, 3CY5, 4CY5

# VHF AMPLIFIER

**Sharp Cutoff Tetrode**

Construction ..... Miniature T-5½  
 Base ..... Button 7 Pin, E7-1  
 Basing ..... 7EW  
 Outline ..... 5-2  
 Maximum Diameter ..... 0.750 In.  
 Maximum Seated Height ..... 1.875 In.  
 Maximum Overall Height ..... 2.125 in.

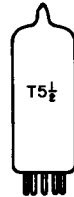
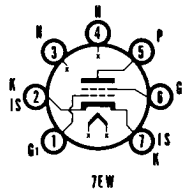

**ELECTRICAL DATA**

**HEATER OPERATION**

	<b>2CY5</b>	<b>3CY5</b>	<b>4CY5</b>	<b>6CY5</b>
Heater Voltage .....	2.4	2.9	4.5	6.3
Heater Current .....	600	450	300	200 Ma
Heater Warm-up Time .....	11	11	11	— Seconds
Maximum Heater-Cathode Voltage .....				100 Volts

**DIRECT INTERELECTRODE CAPACITANCES (Shielded)<sup>(1)</sup>**

Grid No. 1 to Plate .....	0.03 Pf
Input .....	4.5 Pf
Output .....	3.0 Pf

**RATINGS (Design Maximum Rating System)**

Plate Voltage (Max.) .....	180 Volts
Grid No. 2 Supply Voltage (Max.) .....	180 Volts
Grid No. 2 Voltage .....	See Rating Chart (Gen. Info. Sec.)
Plate Dissipation (Max.) .....	2.0 Watts
Grid No. 2 Dissipation (Max.) .....	0.5 Watt
Positive Grid No. 1 Voltage (Max.) .....	0 Volt
Cathode Current (Max.) .....	20 Ma
Grid Circuit Resistance (Max.) .....	0.5 Megohms

**CHARACTERISTICS AND TYPICAL OPERATION**

Plate Voltage .....	125 Volts
Grid No. 2 Voltage .....	80 Volts
Grid No. 1 Voltage .....	-1 Volt
Plate Current .....	10 Ma
Grid No. 2 Current .....	1.5 Ma
Transconductance .....	8000 $\mu$ mhos
Plate Resistance .....	0.1 Megohm
Grid No. 1 Voltage for $I_b = 20 \mu a$ .....	-6 Volts

**NOTE:**

(1) Shield No. 316 connected to cathode.

**VERTICAL DEFLECTION  
OSCILLATOR and AMPLIFIER**

**6CY7**  
8CY7, 11CY7

**Double Dissimilar Triode**

Construction ..... Miniature T-6½  
 Base ..... Button 9 Pin, E9-1  
 Basing ..... 9LG  
 Outline ..... 6-3  
 Maximum Diameter ..... 0.875 In.  
 Maximum Seated Height ..... 2.375 In.  
 Maximum Overall Height ..... 2.625 In.

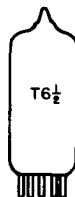
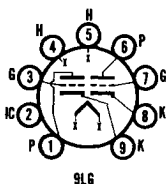

**ELECTRICAL DATA**

**HEATER OPERATION**

	11CY7	8CY7	6CY7
Heater Voltage .....	11	7.9	6.3 Volts
Heater Current .....	450	600	750 Ma
Heater Warm-up Time .....	11	11	— Seconds
Maximum Heater-Cathode Voltage			
Heater Negative with Respect to Cathode			
Total DC and Peak.....			200 Volts
Heater Positive with Respect to Cathode			
DC .....			100 Volts
Total DC and Peak.....			200 Volts

**DIRECT INTERELECTRODE CAPACITANCES (Unshielded)**

	Section No. 1	Section No. 2
Grid to Plate .....	1.8	4.4 Pf
Input: g to (h + k) .....	1.5	5.0 Pf
Output: p to (h + k) .....	0.30	1.0 Pf

**RATINGS (Design Maximum Rating System)**

	Vertical Defl. Osc. (1) Section No. 1	Vertical Defl. Amp. (1) Section No. 2
DC Plate Voltage (Max.) .....	350	350 Volts
Peak Positive Pulse Plate Voltage (Max.) .....	—	1800 Volts
Peak Negative Pulse Grid Voltage (Max.) .....	400	250 Volts
Plate Dissipation (Max.) (2) .....	1.0	5.5 Watts
DC Cathode Current (Max.) .....	—	35 Ma
Peak Cathode Current (Max.) .....	—	120 Ma
Grid Circuit Resistance		
Cathode Bias (Max.) .....	2.2	2.2 Megohms
Fixed Bias (Max.) .....	2.2	— Megohms

**CHARACTERISTICS AND TYPICAL OPERATION**

	Section No. 1	Section No. 2
Plate Voltage .....	250	150 Volts
Grid Voltage .....	-3.0	— Volts
Cathode Bias Resistor .....	—	620 Ohms
Plate Current .....	1.2	30 Ma
Transconductance .....	1300	5400 μmhos
Amplification Factor .....	68	5
Plate Resistance (Approx.) .....	52,000	920 Ohms
Grid Voltage for Ib = 200 μa (Approx.) .....	—	-40 Volts
Grid Voltage for Ib = 10 μa (Approx.) .....	-5.5	— Volts
Plate Current at Ec = -30 VDC (Approx.) .....	—	3.5 Ma

**INSTANTANEOUS PLATE KNEE CHARACTERISTICS**

Eb = 60 V, Ec1 = 0 V, Ib = 80 Ma

**NOTES:**

- (1) For operation in a 525 line, 30 frame system as described in "Standards of Good Engineering Practice for Television Broadcast Stations; Federal Communications Commission," the duty cycle of the voltage pulse must not exceed 15% of one horizontal scanning cycle.
- (2) In stages operating with grid-leak bias, an adequate bias resistor or other suitable means is required to protect the tube in the absence of excitation.

# 6CZ5

5CZ5

Color Television Type

## AUDIO POWER AMP. or VERTICAL DEFLECTION AMP.

**Beam Power Pentode**

Construction ..... Miniature T-6½  
 Base ..... Button 9 Pin, E9-1  
 Basing ..... 9HN  
 Outline ..... 6-4  
 Maximum Diameter ..... 0.875 In.  
 Maximum Seated Height ..... 2.812 In.  
 Maximum Overall Height ..... 3.062 In.

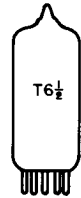
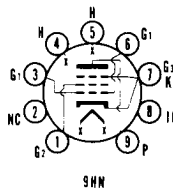

**ELECTRICAL DATA**  
**HEATER OPERATION**

Heater Voltage.....	<b>5CZ5</b>	<b>6CZ5</b>
Heater Current.....	4.7	6.3 Volts
Heater Warm-up Time.....	600	450 Ma
Maximum Heater-Cathode Voltage	11	11 Seconds
Heater Negative with Respect to Cathode		
Total DC and Peak.....		200 Volts
Heater Positive with Respect to Cathode		
DC.....		100 Volts
Total DC and Peak.....		200 Volts

**DIRECT INTERELECTRODE CAPACITANCES**

Grid No. 1 to Plate (Max.).....	0.4 Pf
Input: g1 to (k + h + g3 + g2).....	9.0 Pf
Output: p to (k + h + g3 + g2).....	6.0 Pf

**RATINGS (Design Maximum Rating System)**

	<b>Vertical Deflection Amp.</b>	<b>Class A1 Power Amp.</b>
DC Plate Voltage (Max.).....	350	350 Volts
Peak Positive Plate Voltage (Abs. Max.).....	2200 <sup>(2)</sup>	— Volts
DC Grid No. 2 Voltage (Max.).....	315	285 Volts
Peak Negative Grid No. 1 Voltage (Max.).....	275	— Volts
Plate Dissipation (Max.) <sup>(1)</sup> .....	10	12 Watts
Grid No. 2 Input (Max.).....	2	2 Watts
Average Cathode Current (Max.).....	45	— Ma
Peak Cathode Current (Max.).....	155	— Ma
Grid No. 1 Circuit Resistance		
Fixed Bias (Max.).....	0.5	0.1 Megohm
Cathode Bias (Max.).....	1	1 Megohm
Bulb Temperature (At Hottest Point) (Max.).....	250	250 °C

**CHARACTERISTICS AND TYPICAL OPERATION**

**AF Power Amplifier**

	<b>Single Tube Class A1</b>	<b>Push Pull Class AB1</b>
Plate Voltage.....	250	350 Volts
Grid No. 2 Voltage.....	250	280 Volts
Grid No. 1 Voltage.....	-14	-23.5 Volts
Peak AF Grid No. 1 Voltage.....	13	— Volts
Peak AF Grid to Grid Voltage <sup>(3,4)</sup> .....	—	47 Volts
Zero Signal Plate Current.....	46	46 Ma
Maximum Signal Plate Current.....	48	103 Ma
Zero Signal Grid No. 2 Current.....	4.6	3 Ma
Maximum Signal Grid No. 2 Current.....	8	13 Ma
Transconductance.....	4800	— μmhos
Load Resistance.....	5000	— Ohms
Load Resistance (Plate to Plate).....	—	7500 Ohms
Power Output.....	5.4	21.5 Watts
Total Harmonic Distortion.....	10	1 Percent

**INSTANTANEOUS PLATE KNEE VALUES**

Eb = 70 V, Ec2 = 250 V, Ec1 = 0 V  
 Ib = 130 Ma, Ic2 = 16 Ma

**NOTES:**

- (1) For operation in a 525 line, 30 frame system as described in "Standards of Good Engineering Practice for Television Broadcast Stations; Federal Communications Commission," the duty cycle of the pulse must not exceed 15% of one horizontal scanning cycle.
- (2) Under no circumstances should this absolute value be exceeded.
- (3) No Grid No. 1 Current should flow during any part of the input cycle.
- (4) Low resistance is required by the Grid No. 1 Circuit such as transformer or impedance coupling devices.

**OSCILLATOR, MIXER  
AMPLIFIER or AFC**

**6D10**

**High Mu Triple Triode**

Construction..... Compactron T-9  
 Base ..... Button 12 Pin, E12-70  
 Basing ..... 12BQ  
 Outline ..... 9-56  
 Maximum Diameter ..... 1.188 In.  
 Maximum Seated Height ..... 1.500 In.  
 Maximum Overall Height ..... 1.875 In.

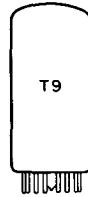
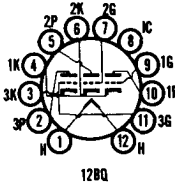

**ELECTRICAL DATA**

**HEATER OPERATION**

Heater Voltage ..... 6.3 Volts  
 Heater Current ..... 450 Ma  
 Maximum Heater-Cathode Voltage  
 Heater Negative with Respect to Cathode  
 Total DC and Peak ..... 200 Volts  
 Heater Positive with Respect to Cathode  
 DC ..... 100 Volts  
 Total DC and Peak ..... 200 Volts

**DIRECT INTERELECTRODE CAPACITANCES (Unshielded) (Each Section)**

Grid to Plate ..... 1.5 Pf  
 Input ..... 2.2 Pf  
 Output ..... 0.5 Pf

**RATINGS (Design Maximum Rating System) (Each Section)**

Plate Voltage (Max.) ..... 330 Volts  
 Plate Dissipation (Each Plate) (Max.) ..... 2.0 Watts  
 Plate Dissipation (Plates 1, 2, and 3) (Max.) ..... 6.0 Watts  
 Positive Grid Voltage (Max.) ..... 0 Volt  
 Negative Grid Voltage (Max.) ..... 50 Volts

**CHARACTERISTICS AND TYPICAL OPERATION**

**Class A1 Amplifier—Each Section**

Plate Voltage ..... 125 Volts  
 Grid Voltage ..... -1.0 Volt  
 Plate Current ..... 4.2 Ma  
 Plate Resistance ..... 13,600 Ohms  
 Transconductance ..... 4200  $\mu$ mhos  
 Amplification Factor ..... 57  
 Ec for Ib = 20  $\mu$ a ..... -4 Volts

**DAMPER**

**6DA4A/6DM4A**  
12D4A, 17D4A

**Heater-Cathode Diode**

Construction ..... Octal T-9  
 Base ..... Octal 5 Pin, B5-85  
 Basing<sup>(1)</sup> ..... 4CG  
 Outline ..... 9-41  
 Maximum Diameter ..... 1.188 In.  
 Maximum Seated Height ..... 2.750 In.  
 Maximum Overall Height ..... 3.313 In.

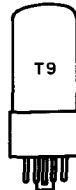
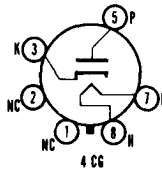

**ELECTRICAL DATA**

**HEATER OPERATION**

	17D4A	12D4A	6DA4A/6DM4A
Heater Voltage.....	16.8	12.6	6.3 Volts
Heater Current.....	450	600	1200 Ma
Heater Warm-up Time.....	11	11	— Seconds
Maximum Heater-Cathode Voltage Heater Negative with Respect to Cathode			
DC.....			1000 Volts
Total DC and Peak.....			5000 Volts

Heater Positive with Respect to Cathode	
DC .....	100 Volts
Total DC and Peak.....	300 Volts

**DIRECT INTERELECTRODE CAPACITANCES**

Heater to Cathode .....	3.0 Pf
Plate to Cathode and Heater.....	9.0 Pf
Cathode to Plate and Heater.....	7.0 Pf

**RATINGS (Design Maximum Rating System)**

**Damper Service<sup>(2)</sup>**

Peak Inverse Plate Voltage (Max.) .....	5000 Volts
Plate Dissipation (Max.) .....	8.0 Watts
Steady State Peak Current (Max.) .....	900 Ma
DC Plate Current (Max.) .....	185 Ma

**CHARACTERISTICS AND TYPICAL OPERATION**

Tube Voltage Drop for Ib = 340 Ma .....	30 Volts
---	----------

**NOTES:**

- (1) Pins 1, 2, 4, and 6 should not be used as tie points.
- (2) For operation in a 525 line, 30 frame system as described in "Standards of Good Engineering Practice for Television Broadcast Stations; Federal Communications Commission," the duty cycle of the voltage pulse must not exceed 15% of one horizontal scanning cycle.



**Heater-Cathode Diode**

Construction .....	Octal T-9
Base <sup>(1)</sup> .....	Octal 5 Pin, B5-85
Basing <sup>(2)</sup> .....	4CG
Outline .....	9-44
Maximum Diameter .....	1.188 In.
Maximum Seated Height .....	3.250 In.
Maximum Overall Height .....	3.813 In.

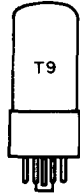
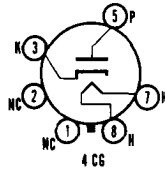

**ELECTRICAL DATA**

**HEATER OPERATION**

	22DE4	17DE4	6DE4
Heater Voltage.....	22.4	17	6.3 Volts
Heater Current .....	450	600	1600 Ma
Heater Warm-up Time .....	11	11	— Seconds
Maximum Heater-Cathode Voltage			
Heater Negative with Respect to Cathode			
DC .....			900 Volts
Total DC and Peak.....			5500 Volts
Heater Positive with Respect to Cathode			
DC .....			100 Volts
Total DC and Peak.....			300 Volts

**DIRECT INTERELECTRODE CAPACITANCES (Unshielded)**

Heater to Cathode .....	4 Pf
Plate to Cathode and Heater.....	8.5 Pf
Cathode to Plate and Heater.....	11.5 Pf

**RATINGS (Design Maximum Rating System)**

**Damper Service**

Peak Inverse Plate Voltage (Max.) <sup>(3)</sup> .....	5500 Volts
Plate Dissipation (Max.) .....	6.5 Watts
Steady State Peak Current (Max.) .....	1100 Ma
DC Plate Current (Max.) .....	180 Ma

**CHARACTERISTICS AND TYPICAL OPERATION**

Tube Voltage Drop for Ib = 350 Ma .....	34 Volts
---	----------

**NOTES:**

- (1) On some base arrangements Pins 1, 4, and 6 are omitted.
- (2) Pins 1, 2, 4, and 6 should not be used as tie points.
- (3) For operation in a 525 line, 30 frame system as described in "Standards of Good Engineering Practice for Television Broadcast Stations; Federal Communications Commission," the duty cycle of the voltage pulse must not exceed 15% of one horizontal scanning cycle.

Color Television Type  
**IF AMPLIFIER**

**6DE6**  
4DE6

**Sharp Cutoff Pentode**

Construction ..... Miniature T-5½  
 Base ..... Button 7 Pin, E7-1  
 Basing ..... .7CM  
 Outline ..... 5-2  
 Maximum Diameter ..... 0.750 In.  
 Maximum Seated Height ..... 1.875 In.  
 Maximum Overall Height ..... 2.125 In.

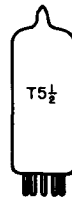
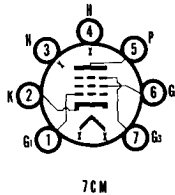

**ELECTRICAL DATA**

**HEATER OPERATION**

	4DE6	6DE6
Heater Voltage.....	4.2	6.3 Volts
Heater Current .....	450	300 Ma
Heater Warm-up Time .....	11	— Seconds
Maximum Heater-Cathode Voltage		
Heater Negative with Respect to Cathode		200 Volts
Total DC and Peak.....		
Heater Positive with Respect to Cathode		200 Volts
DC .....		100 Volts
Total DC and Peak.....		200 Volts

**DIRECT INTERELECTRODE CAPACITANCES**

	Shielded	Unshielded
Grid No. 1 to Plate .....	0.015	0.025 Pf
Input: g1 to (h + k + g2 + g3 + IS) .....	6.5	6.5 Pf
Output: p to (h + k + g2 + g3 + IS).....	3.0	2.0 Pf

**RATINGS (Design Maximum Rating System)**

**Class A1 Amplifier**

Plate Voltage (Max.) .....	330 Volts
Grid No. 2 Supply Voltage (Max.) .....	330 Volts
Grid No. 2 Voltage .....	See Rating Chart (Gen. Info. Sec.)
Plate Dissipation (Max.) .....	2.3 Watts
Grid No. 2 Input (Max.) .....	0.55 Watt
Positive Grid No. 1 Voltage (Max.) .....	0 Volt

**CHARACTERISTICS AND TYPICAL OPERATION**

**Class A1 Amplifier**

Plate Voltage .....	125 Volts
Grid No. 3 Voltage .....	Connected to Cathode at Socket
Grid No. 2 Voltage .....	125 Volts
Cathode Bias Resistor .....	56 Ohms
Plate Current .....	15.5 Ma
Grid No. 2 Current .....	4.2 Ma
Transconductance .....	8000 μmhos
Plate Resistance (Approx.) .....	0.25 Megohm
Transconductance with $E_{c1} = -5.5$ , $R_k = 0$ .....	700 μmhos
$E_{c1}$ for $I_b = 20 \mu a$ .....	-9 Volts

**VERTICAL DEFLECTION  
OSCILLATOR and AMPLIFIER**

**6DE7**  
10DE7, 13DE7, 19DE7

**Dissimilar Double Triode**

Construction ..... Miniature T-6½  
 Base ..... Button 9 Pin, E9-1  
 Basing ..... .9HF  
 Outline ..... 6-3  
 Maximum Diameter ..... 0.875 In.  
 Maximum Seated Height ..... 2.375 In.  
 Maximum Overall Height ..... 2.625 In.

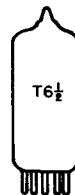
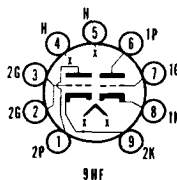

**ELECTRICAL DATA  
HEATER OPERATION**

	19DE7	13DE7	10DE7	6DE7
Heater Voltage.....	19.4	13.0	9.7	6.3 Volts
Heater Current .....	300	450	600	900 Ma
Heater Warm-up Time .....	11	11	11	— Seconds
Maximum Heater-Cathode Voltage				
Heater Negative with Respect to Cathode				
Total DC and Peak.....				200 Volts
Heater Positive with Respect to Cathode				
DC .....				100 Volts
Total DC and Peak.....				200 Volts

**DIRECT INTERELECTRODE CAPACITANCES (Unshielded)**

	Section No. 1	Section No. 2
Grid to Plate .....	4.0	8.5 Pf
Input: g to (h + k) .....	2.2	5.5 Pf
Output: p to (h + k) .....	0.52	1.0 Pf

**RATINGS (Design Maximum Rating System)  
Vertical Deflection Oscillator and Amplifier<sup>(1)</sup>**

	Section No. 1 Oscillator	Section No. 2 Amplifier
DC Plate Voltage (Max.) .....	330	275 Volts
Peak Positive Pulse Plate Voltage (Abs. Max.).....	—	1500 Volts
Peak Negative Pulse Grid Voltage (Max.) .....	400	250 Volts
Plate Dissipation (Max.) <sup>(2)</sup> .....	1.5	7.0 Watts
Average Cathode Current (Max.).....	22	50 Ma
Peak Cathode Current (Max.).....	77	175 Ma
Grid Circuit Resistance (Self Bias) (Max.).....	2.2	2.2 Megohms

**CHARACTERISTICS AND TYPICAL OPERATION**

	Section No. 1	Section No. 2
Plate Voltage .....	250	150 Volts
Grid No. 1 Voltage .....	-11	-17.5 Volts
Plate Current .....	5.5	35 Ma
Transconductance .....	2000	6500 $\mu$ mhos
Amplification Factor .....	17.5	6.0
Plate Resistance (Approx.) .....	8750	925 Ohms
Grid Voltage for $I_b = 10 \mu a$ .....	-20	— Volts
Grid Voltage for $I_b = 50 \mu a$ .....	—	-44 Volts
Plate Current at $E_c = -24 Vdc$ .....	—	10 Ma
Zero Bias Plate Current		
$E_b = 60 V$ ; $E_c = 0$ (Instantaneous Values) .....	—	80 Ma

**NOTES:**

- (1) For operation in a 525 line, 30 frame system as described in "Standards of Good Engineering Practice for Television Broadcast Stations; Federal Communications Commission," the duty cycle of the voltage pulse must not exceed 15% of one horizontal scanning cycle.
- (2) In stages operating with grid leak bias, an adequate bias resistor or other suitable means is required to protect the tube in the absence of excitation.

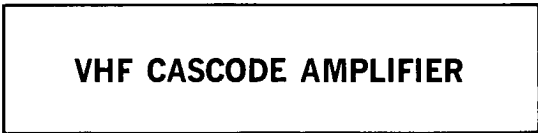

**Double Triode**

Construction .....	Miniature T-6½
Base .....	Button 9 Pin, E9-1
Basing .....	9AJ
Outline .....	6-2
Maximum Diameter .....	0.875 In.
Maximum Seated Height .....	1.937 In.
Maximum Overall Height .....	2.187 In.

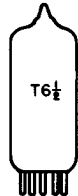
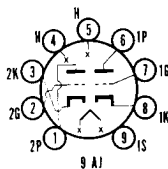

**ELECTRICAL DATA  
HEATER OPERATION**

	12DJ8	7DJ8	6DJ8
Heater Voltage.....	12.6	7.0	6.3 Volts
Heater Current .....	180	300	365 Ma
Maximum Heater-Cathode Voltage			
RMS, Voltage Between Cathode and Heater			
(Grounded Cathode Section).....	50	80	50 Volts



DC Component of Cathode to Heater Voltage (Grounded Grid Section).....	130	130	130 Volts
Peak Voltage Between Cathode and Heater; Cathode Positive with Respect to Heater (Grounded Grid Section) .....	150	180	150 Volts

**DIRECT INTERELECTRODE CAPACITANCES**

	Unshielded	Shielded
<b>Grounded-Cathode Section<sup>(1)</sup></b>		
Grid to All Elements Except Plate.....	3.3	3.3 Pf
Plate to All Elements Except Grid.....	1.8	2.5 Pf
Plate to Grid .....	1.4	1.4 Pf
Grid to Heater .....	0.13	0.13 Pf
<b>Grounded-Grid Section<sup>(1)</sup></b>		
Cathode to All Elements Except Plate .....	6.0	6.0 Pf
Plate to All Elements Except Cathode .....	2.8	3.7 Pf
Plate to Grid .....	1.4	1.4 Pf
Cathode to Heater .....	2.7	2.7 Pf
Plate to Cathode.....	0.18	0.16 Pf
Plate (Grounded-Grid Section) to Plate (Grounded-Cathode Section) (Max.) .....	0.045	0.15 Pf
Grid (Grounded-Cathode Section) to Plate (Grounded-Grid Section) (Max.) .....	0.005	0.005 Pf

**RATINGS (Design Center Rating System) (Each Section)**

Plate Supply Voltage (I <sub>b</sub> = 0 Ma) (Max.).....	550 Volts
Plate Voltage (Max.) <sup>(2)</sup> .....	130 Volts
Plate Dissipation (Max.) .....	1.8 Watts
Cathode Current (Max.).....	25 Ma
Negative Grid Voltage (Max.) .....	50 Volts
Grid Circuit Resistance (Max.).....	1.0 Megohm

**CHARACTERISTICS AND TYPICAL OPERATION**

**Class A1 Amplifier (Each Section)**

Plate Voltage .....	90 Volts
Grid Voltage .....	-1.3 Volts
Plate Current .....	15 Ma
Transconductance .....	12,500 μmhos
Amplification Factor .....	33
Equivalent Noise Resistance .....	300 Ohms

**NOTES:**

- (1) Grounded-cathode section (Section No. 1) connects to Pins 6, 7, and 8. Grounded-grid section (Section No. 2) connects to Pins 1, 2, and 3.
- (2) In order not to exceed the maximum permissible plate voltage when the cascode amplifier has AGC voltage applied to it, a voltage divider is recommended for the grid of the grounded-grid section (Circuit A).  
With grid current biasing for the grounded-cathode section, the plate voltage across this section should not exceed 75 volts when an AGC voltage is not utilized (Circuit B).

**CIRCUIT A**

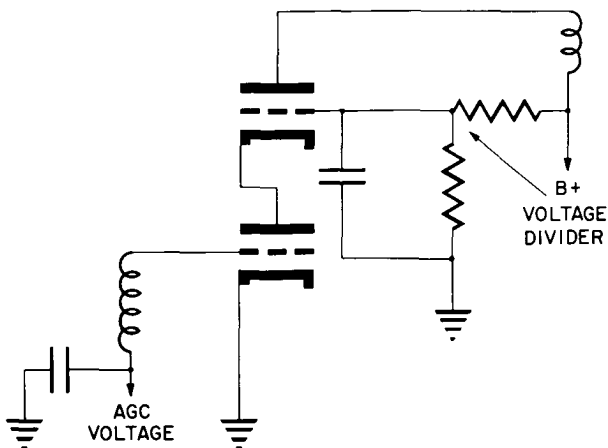

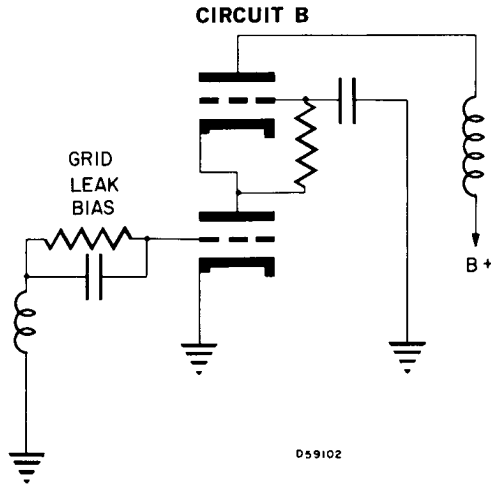

**6DK6**  
3DK6, 4DK6, 12DK6

Color Television Type  
**IF AMPLIFIER**

**Sharp Cutoff Pentode**

- Construction ..... Miniature T-5½
- Base ..... Button 7 Pin, E7-1
- Basing ..... .7CM
- Outline ..... 5-2
- Maximum Diameter ..... 0.750 In.
- Maximum Seated Height ..... 1.875 In.
- Maximum Overall Height ..... 2.125 In.

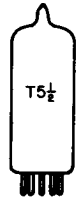
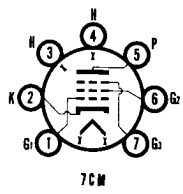

**ELECTRICAL DATA**  
**HEATER OPERATION**

	12DK6	4DK6	3DK6	6DK6
Heater Voltage.....	12.6	4.2	3.15	6.3 Volts
Heater Current .....	150	450	600	300 Ma
Heater Warm-up Time .....	—	11	11	— Seconds
Maximum Heater-Cathode Voltage				
Heater Negative with Respect to Cathode				
DC Component .....	—	200	200	— Volts
Total DC and Plate.....	200	300	300	200 Volts
Heater Positive with Respect to Cathode				
DC .....	100	100	100	100 Volts
Total DC and Peak .....	200	200	200	200 Volts

**DIRECT INTERELECTRODE CAPACITANCES (Unshielded)**

Grid No. 1 to Plate (Max.).....	0.025 Pf
Input .....	6.3 Pf
Output .....	1.9 Pf

**RATINGS (Design Maximum Rating System)**

Plate Voltage (Max.) .....	330 Volts
Grid No. 2 Supply Voltage (Max.) .....	330 Volts
Grid No. 2 Voltage .....	See Rating Chart (Gen. Info. Sec.)
Plate Dissipation (Max.) .....	2.3 Watts
Grid No. 2 Dissipation (Max.) .....	0.55 Watt
Positive Grid No. 1 Voltage (Max.) .....	0 Volt

**CHARACTERISTICS AND TYPICAL OPERATION**

Plate Voltage .....	125 Volts
Grid No. 3 Voltage (Suppressor) .....	Connected to Cathode at Socket
Grid No. 2 Voltage .....	125 Volts
Cathode Bias Resistor .....	56 Ohms
Plate Current .....	12.0 Ma
Grid No. 2 Current .....	3.8 Ma
Transconductance .....	9800 $\mu$ hmhos
Plate Resistance.....	0.35 Megohm
Grid No. 1 Bias for Ib of 20 $\mu$ a (Approx.).....	-6.5 Volts

**VERTICAL DEFLECTION  
OSCILLATOR and AMPLIFIER**

**6DN7**

**Double Dissimilar Triode**

Construction .....Octal T-9  
 Base .....Octal 8 Pin, B8-142  
 Basing .....8BD  
 Outline  
 Maximum Diameter .....1.188 In.  
 Maximum Seated Height .....2.438 In.  
 Maximum Overall Height .....3.000 In.

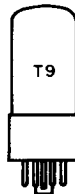
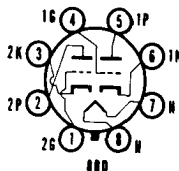

**ELECTRICAL DATA**

**HEATER OPERATION**

Heater Voltage.....	6.3 Volts
Heater Current .....	900 Ma
Maximum Heater-Cathode Voltage	
Heater Positive with Respect to Cathode	
DC Component .....	100 Volts
Total DC and Peak.....	200 Volts
Heater Negative with Respect to Cathode	
Total DC and Peak.....	200 Volts

**DIRECT INTERELECTRODE CAPACITANCES (Unshielded)**

	Section 1	Section 2
Grid to Plate .....	4.0	5.5 Pf
Input .....	2.2	4.6 Pf
Output .....	0.7	1.0 Pf

**RATINGS (Design Maximum Rating System)**

	Vertical Oscillator Service (Section 1) <sup>(1)</sup>	Vertical Deflection Service (Section 2) <sup>(1)</sup>
DC Plate Voltage (Max.) .....	350	550 Volts
Peak Positive Pulse Plate Voltage (Max.) .....	—	2500 Volts
Peak Negative Grid Voltage (Max.) .....	400	250 Volts
Plate Dissipation (Max.) .....	1.0	10 <sup>(2)</sup> Watts
DC Cathode Current (Max.) .....	—	50 Ma
Peak Cathode Current (Max.).....	—	150 Ma
Grid Circuit Resistance		
With Fixed Bias (Max.) .....	2.2	2.2 Megohms
With Cathode Bias (Max.) .....	2.2	— Megohms

**CHARACTERISTICS AND TYPICAL OPERATION**

	Section 1 (Oscillator)	Section 2 (Amplifier)
Plate Voltage .....	250	150 250 Volts
Grid Voltage .....	-8.0	0 <sup>(3)</sup> -9.5 Volts
Amplification Factor .....	22.5	— 15.4
Plate Resistance (Approx.) .....	9000	— 2000 Ohms
Transconductance .....	2500	— 7700 $\mu$ mhos
Plate Current .....	8.0	68 41 Ma
Grid Voltage (Approx.)		
I <sub>b</sub> = 10 $\mu$ a.....	-18	— -22 Volts
I <sub>b</sub> = 50 $\mu$ a.....	—	— -23 Volts

**NOTES:**

- (1) For operation in a 525 line, 30 frame system as described in "Standards of Good Engineering Practice for Television Broadcast Stations; Federal Communications Commission," the duty cycle of the voltage pulse must not exceed 15% of one horizontal scanning cycle.
- (2) In stages operating with grid-leak bias, an adequate cathode-bias resistor or other suitable means is required to protect the tube in the absence of excitation.
- (3) Applied for short interval (two seconds maximum) so as not to damage tube.

# 6DQ4

12DQ4, 17DQ4

# DAMPER

## Heater-Cathode Diode

Construction ..... Octal T-9  
 Base ..... Octal 5 Pin  
 Basing ..... 4CG  
 Outline ..... 9-15  
 Maximum Diameter ..... 1.188 In.  
 Maximum Seated Height ..... 2.875 In.  
 Maximum Overall Height ..... 3.438 In.

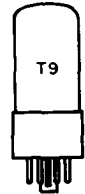
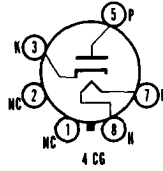

## ELECTRICAL DATA HEATER OPERATION

	17DQ4	12DQ4	6DQ4
Heater Voltage.....	16.8	12.6	6.3 Volts
Heater Current.....	450	600	1200 Ma
Heater Warm-up Time.....	11	11	— Seconds
Maximum Heater-Cathode Voltage			
Heater Negative with Respect to Cathode			
DC.....			900 Volts
Total DC and Peak.....			5500 Volts
Heater Positive with Respect to Cathode			
DC.....			100 Volts
Total DC and Peak.....			300 Volts

## DIRECT INTERELECTRODE CAPACITANCES

Heater to Cathode.....	4.0 Pf
Plate to Cathode and Heater.....	5.0 Pf
Cathode to Plate and Heater.....	8.5 Pf

## RATINGS (Design Maximum Rating System)

Peak Inverse Plate Voltage (Max.).....	5500 Volts
Steady State Peak Plate Current (Max.).....	1000 Ma
DC Output Current (Max.).....	175 Ma
Plate Dissipation (Max.).....	6.0 Watts

## CHARACTERISTICS AND TYPICAL OPERATION

Tube Voltage Drop for Ib = 250 Ma.....	32 Volts
--	----------

# 6DQ5

## Color Television Type HORIZONTAL DEFLECTION AMPLIFIER

## Beam Power Pentode

Construction ..... Octal T-12  
 Base ..... Octal 8 Pin, B8-118  
 Top Cap ..... C1-1  
 Basing ..... 8JC  
 Outline ..... 12-21  
 Maximum Diameter ..... 1.563 In.  
 Maximum Seated Height ..... 4.250 In.  
 Maximum Overall Height ..... 5.000 In.

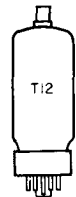
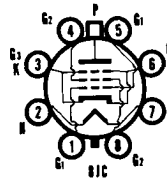

## ELECTRICAL DATA HEATER OPERATION

Heater Voltage.....	6.3 Volts
Heater Current.....	2500 Ma
Maximum Heater-Cathode Voltage	
Heater Negative with Respect to Cathode	
Total DC and Peak.....	200 Volts
Heater Positive with Respect to Cathode	
DC.....	100 Volts
Total DC and Peak.....	200 Volts

## DIRECT INTERELECTRODE CAPACITANCES (Unshielded)

Grid No. 1 to Plate.....	0.5 Pf
Input.....	23 Pf
Output.....	11 Pf

**RATINGS (Design Maximum Rating System)**

**Horizontal Deflection Amplifier<sup>(1)</sup>**

DC Plate Supply Voltage (Boost + DC Power Supply) (Max.) .....	900 Volts
Peak Positive Pulse Plate Voltage (Max.) .....	7000 Volts
Peak Negative Pulse Plate Voltage (Max.) .....	1500 Volts
Grid No. 2 Voltage (Max.) .....	175 Volts
Peak Negative Grid No. 1 Voltage (Max.) .....	200 Volts
Plate Dissipation (Max.) <sup>(2)</sup> .....	24 Watts
Grid No. 2 Dissipation (Max.) .....	3.2 Watts
Average Cathode Current (Max.) .....	285 Ma
Peak Cathode Current (Max.) .....	1000 Ma
Grid No. 1 Circuit Resistance (Max.) .....	0.47 Megohm
Temperature (At Hottest Point) (Max.) .....	240 °C

**CHARACTERISTICS AND TYPICAL OPERATION**

Plate Voltage .....	175 Volts
Grid No. 2 Voltage .....	125 Volts
Grid No. 1 Voltage .....	-25 Volts
Plate Current .....	110 Ma
Grid No. 2 Current .....	5 Ma
Transconductance .....	10,500 $\mu$ mhos
Plate Resistance (Approx.) .....	5500 Ohms
Amplification Factor <sup>(3)</sup> .....	3.3
E <sub>c1</sub> for I <sub>b</sub> = 1.0 Ma .....	-75 Volts

**INSTANTANEOUS PLATE KNEE VALUES**

E<sub>b</sub> = 70 V, E<sub>c2</sub> = 125 V, and E<sub>c1</sub> = 0 V  
 I<sub>b</sub> = 550 Ma, and I<sub>c2</sub> = 42 Ma

**NOTES:**

- (1) For operation in a 525 line, 30 frame system as described in "Standards of Good Engineering Practice for Television Broadcast Stations; Federal Communications Commission," the duty cycle of the voltage pulse must not exceed 15% of one horizontal scanning cycle.
- (2) In stages operating with grid leak bias, an adequate cathode bias resistor or other suitable means is required to protect the tube in the absence of excitation.
- (3) Triode connected with E<sub>b</sub> and E<sub>c2</sub> = 125 V and E<sub>c1</sub> = -25 V.

Color Television Type

## HORIZONTAL DEFLECTION AMPLIFIER

# 6DQ6B/6GW6

12DQ6B/12GW6  
17DQ6B/17GW6

**Beam Power Pentode**

Construction .....	Octal T-12
Base .....	5, 6 or 7 Pin, B5-190, B6-122 B6-148, B7-111 or B7-119
Top Cap .....	C1-2 or C1-3
Basing .....	.6AM
Outline .....	.12-19
Maximum Diameter .....	1.563 In.
Maximum Seated Height .....	3.688 In.
Maximum Overall Height .....	4.250 In.

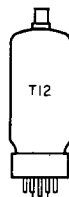
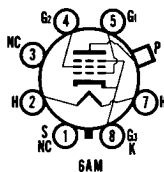

**ELECTRICAL DATA**  
**HEATER OPERATION**

	17DQ6B/ 17GW6	12DQ6B/ 12GW6	6DQ6B/ 6GW6
Heater Voltage .....	16.8	12.6	6.3 Volts
Heater Current .....	450	600	1200 Ma
Heater Warm-up Time .....	11	11	— Seconds
Maximum Heater-Cathode Voltage			
Heater Negative with Respect to Cathode			
Total DC and Peak .....	200 Volts		
Heater Positive with Respect to Cathode			
DC .....			
Total DC and Peak .....	200 Volts		
<b>DIRECT INTERELECTRODE CAPACITANCES (Unshielded)</b>			
Grid No. 1 to Plate .....	0.5 Pf		
Input .....	15.0 Pf		
Output .....	7.0 Pf		

**RATINGS (Design Maximum Rating System)**

**Horizontal Deflection Amplifier<sup>(1)</sup>**

DC Plate Supply Voltage (Boost + DC Power Supply) (Max.) .....	770 Volts
Peak Positive Pulse Plate Voltage .....	6500 Volts
Peak Negative Pulse Plate Voltage (Max.) .....	1500 Volts
Grid No. 2 Voltage (Max.) .....	220 Volts
Grid No. 1 Voltage (Max.) .....	-55 Volts

Peak Negative Grid No. 1 Voltage (Max.) .....	330 Volts
Plate Dissipation (Max.) <sup>(2)</sup> .....	18 Watts
Grid No. 2 Input (Max.) .....	3.6 Watts
Average Cathode Current (Max.) .....	175 Ma
Peak Cathode Current (Max.) .....	610 Ma
Grid No. 1 Circuit Resistance (Max.) .....	1.0 Megohm
Bulb Temperature (At Hottest Point) (Max.) .....	220 °C

**CHARACTERISTICS AND TYPICAL OPERATION**

Plate Voltage .....	250 Volts
Grid No. 2 Voltage .....	150 Volts
Grid No. 1 Voltage .....	-22.5 Volts
Plate Current .....	65 Ma
Grid No. 2 Current .....	1.8 Ma
Transconductance .....	7300 $\mu$ mhos
Amplification Factor <sup>(3)</sup> .....	4.4
Plate Resistance .....	18,000 Ohms
Ec1 for Ib = 1.0 Ma (Approx.) .....	-42 Volts

**INSTANTANEOUS PLATE KNEE VALUES**

Eb = 60 V, Ec2 = 150 V and Ec1 = 0 V

Ib = 345 Ma, and Ic2 = 27 Ma

**NOTES:**

- (1) For operation in a 525 line, 30 frame system as described in "Standards of Good Engineering Practice for Television Broadcast Stations; Federal Communications Commission," the duty cycle of the voltage pulse must not exceed 15% of one horizontal scanning cycle.
- (2) In stages operating with grid leak bias, an adequate bias resistor or other suitable means is required to protect the tube in the absence of excitation.
- (3) Amplification factor with tube operating as a triode with 150 volts on the plate and Grid No. 2 and -22.5 volts on Grid No. 1.

**AVERAGE PLATE CHARACTERISTICS**

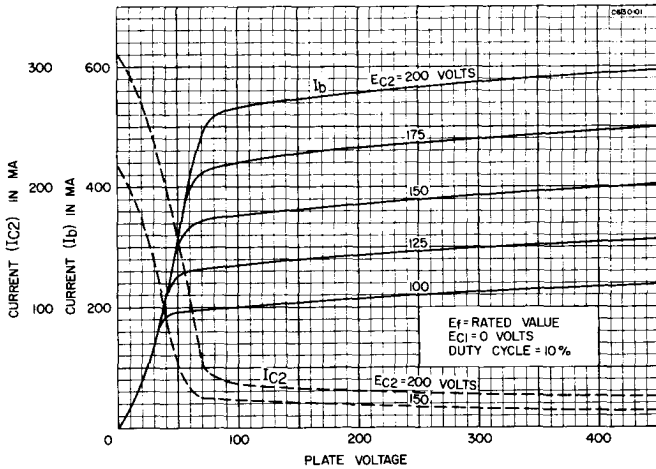

**6DR7**  
10DR7, 13DR7

**VERTICAL DEFLECTION  
OSCILLATOR and AMPLIFIER**

**Double Dissimilar Triode**

Construction .....	Miniature T-6½
Base .....	Button 9 Pin, E9-1
Basing .....	.9HF
Outline .....	.6-3
Maximum Diameter .....	0.875 In.
Maximum Seated Height .....	2.375 In.
Maximum Overall Height .....	2.625 In.

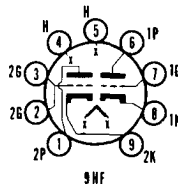

**ELECTRICAL DATA  
HEATER OPERATION**

	13DR7	10DR7	6DR7
Heater Voltage.....	13	9.7	6.3 Volts
Heater Current.....	450	600	900 Ma
Heater Warm-up Time.....	11	11	— Seconds
Maximum Heater-Cathode Voltage			
Heater Negative with Respect to Cathode			
Total DC and Peak.....	200 Volts		
Heater Positive with Respect to Cathode			
DC.....	100 Volts		
Total DC and Peak.....	200 Volts		

**DIRECT INTERELECTRODE CAPACITANCES (Unshielded)**

	Section No. 1	Section No. 2
Grid to Plate.....	4.5	8.5 Pf
Input: g to (h + k).....	2.2	5.5 Pf
Output: p to (h + k).....	0.34	1.0 Pf

**RATINGS (Design Maximum Rating System)  
Vertical Deflection Oscillator and Amplifier<sup>(1)</sup>**

	Section No. 1 Oscillator	Section No. 2 Amplifier
Plate Voltage (Max.).....	330	275 Volts
Peak Positive Pulse Plate Voltage (Abs. Max.).....	—	1500 Volts
Peak Negative Pulse Grid Voltage (Max.).....	400	250 Volts
Plate Dissipation (Max.) <sup>(2)</sup> .....	1.0	7.0 Watts
Average Cathode Current (Max.).....	20	50 Ma
Peak Cathode Current (Max.).....	70	175 Ma
Grid Circuit Resistance Self Bias.....	2.2	2.2 Megohms

**CHARACTERISTICS AND TYPICAL OPERATION**

	Section No. 1	Section No. 2
Plate Voltage.....	250	150 Volts
Grid No. 1 Voltage.....	-3	-17.5 Volts
Plate Current.....	1.4	35 Ma
Transconductance.....	1600	6500 $\mu$ mhos
Amplification Factor.....	68	6.0
Plate Resistance (Approx.).....	40,000	925 Ohms
Ec for Ib = 10 $\mu$ a (Approx.).....	-5.5	— Volts
Ec for Ib = 50 $\mu$ a (Approx.).....	—	-44 Volts
Ib at Ec = -24 Vdc (Approx.).....	—	10 Ma

**INSTANTANEOUS PLATE KNEE VALUES (Section No. 2)**

Eb = 60 V; Ec = 0  
Ib = 80 Ma

**NOTES:**

- (1) For operation in a 525 line, 30 frame system as described in "Standards of Good Engineering Practice for Television Broadcast Stations; Federal Communications Commission," the duty cycle of the voltage pulse must not exceed 15% of one horizontal scanning cycle.
- (2) In stages operating with grid leak bias, an adequate bias resistor or other suitable means is required to protect the tube in the absence of excitation.

**AVERAGE PLATE CHARACTERISTICS  
(Section No. 1)**

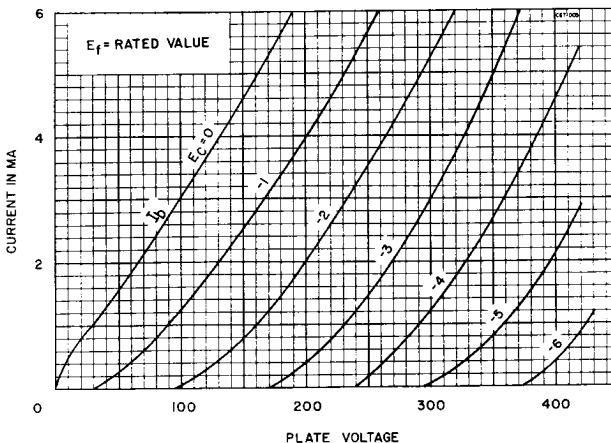

**AVERAGE PLATE CHARACTERISTICS  
(Section No. 2)**

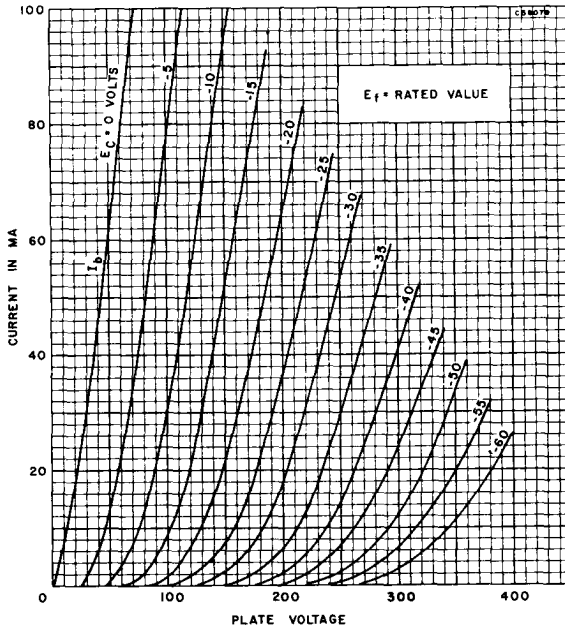

**6DS4**  
2DS4

Color Television Type  
**VHF AMPLIFIER**

**High Mu Triode**

Construction .....Nuvistor, Metal Base..Ceramic Wafer Twelvar 5 Pin, E5-65 Basing .....12AQ Outline

Maximum Diameter .....0.440 In.  
Maximum Seated Height .....0.625 In.  
Maximum Overall Height .....0.800 In.

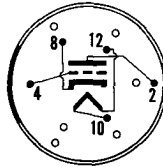

**ELECTRICAL DATA  
HEATER OPERATION**

Heater Voltage.....	2DS4 2.1	6DS4 6.3 Volts
Heater Current .....	450	135 Ma
Heater Warm-up Time .....	8	— Seconds

Maximum Heater-Cathode Voltage		
Heater Negative with Respect to Cathode		100 Volts
Total DC and Peak.....		100 Volts
Heater Positive with Respect to Cathode		
Total DC and Peak.....		100 Volts

**DIRECT INTERELECTRODE CAPACITANCES**

Grid to Plate .....	0.92 Pf
Input: g to (h + Shell) .....	4.3 Pf
Output: p to (h + k + Shell) .....	1.8 Pf
Heater to Cathode .....	1.6 Pf
Plate to Cathode .....	0.18 Pf

**RATINGS (Design Maximum Rating System)**

Plate Supply Voltage (Max.) .....	300 Volts
Plate Voltage (Max.) .....	135 Volts

12AQ

2DS4

6DS4



Plate Dissipation (Max.) .....	1 Watt
DC Cathode Current (Max.) .....	15 Ma
Negative Grid Voltage (Max.) .....	55 Volts
Positive Grid Voltage (Max.) .....	0 Volt
Grid Circuit Resistance	
Fixed Bias (Max.) .....	0.5 Megohm
Self Bias (Max.) .....	2.2 Megohm

**CHARACTERISTICS AND TYPICAL OPERATION**

**Class A1 Amplifier**

Plate Voltage .....	70	110 Volts
Grid Resistor .....	47,000	— Ohms
Cathode Resistor .....	—	130 Ohms
Plate Current .....	7	6.5 Ma
Transconductance .....	12,500	9000 $\mu$ mhos
Amplification Factor .....	68	63
Plate Resistance (Approx.) .....	5440	7000 Ohms
Ec for Ib = 100 $\mu$ a (Approx.) .....	—	-5 Volts
Ec for Ib = 10 $\mu$ a (Approx.) .....	—	-6.8 Volts

**VERTICAL DEFLECTION  
AMPLIFIER**

**6DT5**  
12DT5, 25DT5

**Beam Power Pentode**

Construction .....	Miniature T-6½
Base .....	Button 9 Pin, E9-1
Basing .....	9HN
Outline .....	6-3
Maximum Diameter .....	0.875 In.
Maximum Seated Height .....	2.375 In.
Maximum Overall Height .....	2.625 In.

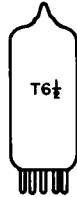
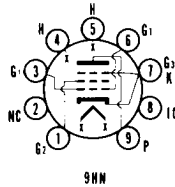

**ELECTRICAL DATA**

**HEATER OPERATION**

	25DT5	12DT5	6DT5
Heater Voltage .....	25	12.6	6.3 Volts
Heater Current .....	300	600	1200 Ma
Heater Warm-up Time .....	11	11	— Seconds
Maximum Heater-Cathode Voltage			
Heater Negative with Respect to Cathode			
Total DC and Peak .....			200 Volts
Heater Positive with Respect to Cathode			
DC .....			100 Volts
Total DC and Peak .....			200 Volts

**DIRECT INTERELECTRODE CAPACITANCES (Unshielded)**

Grid No. 1 to Plate .....	0.57 Pf
Input: g1 to (h + k) .....	12.5 Pf
Output: p to (h + k) .....	4.9 Pf

**RATINGS (Design Maximum Rating System)**

**Vertical Deflection Amplifier<sup>(1)</sup>**

Plate Voltage (Max.) .....	315 Volts
Grid No. 2 Voltage (Max.) .....	285 Volts
Peak Positive Pulse Plate Voltage (Abs. Max.) .....	2200 Volts
Peak Negative Pulse Grid Voltage (Max.) .....	250 Volts
Plate Dissipation (Max.) <sup>(2)</sup> .....	9.0 Watts
Grid No. 2 Dissipation (Max.) <sup>(2)</sup> .....	2.0 Watts
Average Cathode Current (Max.) .....	55 Ma
Peak Cathode Current (Max.) .....	190 Ma
Grid Circuit Resistance	
Fixed Bias (Max.) .....	0.5 Megohm
Cathode Bias (Max.) .....	1.0 Megohm

**CHARACTERISTICS AND TYPICAL OPERATION**

Plate Voltage .....	250 Volts
Grid No. 2 Voltage .....	250 Volts
Grid No. 1 Voltage .....	-16.5 Volts
Plate Current .....	38 Ma
Grid No. 2 Current .....	2.0 Ma
Transconductance .....	6200 $\mu$ mhos
Ec1 for Ib = 100 $\mu$ a (Approx.) .....	-35 Volts

**INSTANTANEOUS PLATE KNEE VALUES**

Zero Bias: With  $E_b = 60\text{ V}$  and  $E_{c2} = 150\text{ V}$

Plate Current .....	100 Ma
Grid No. 2 Current .....	15 Ma

**NOTES:**

- (1) For operation in a 525 line, 30 frame system as described in "Standards of Good Engineering Practice for Television Broadcast Stations; Federal Communications Commission," the duty cycle of the voltage pulse must not exceed 15% of one horizontal scanning cycle.
- (2) In stages operating with grid leak bias, an adequate bias resistor or other suitable means is required to protect the tube in the absence of excitation.

# 6DT6A

3DT6A, 4DT6A

Color Television Type

# FM DETECTOR

**Sharp Cutoff Pentode**

Construction ..... Miniature T-5½  
 Base ..... Button 7 Pin, E7-1  
 Basing ..... 7EN  
 Outline ..... 5-2  
     Maximum Diameter ..... 0.750 In.  
     Maximum Seated Height ..... 1.875 In.  
     Maximum Overall Height ..... 2.125 In.

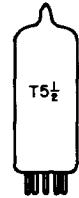
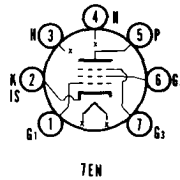

**ELECTRICAL DATA  
HEATER OPERATION**

	3DT6A	4DT6A	6DT6A
Heater Voltage.....	3.15	4.2	6.3 Volts
Heater Current .....	600	450	300 Ma
Heater Warm-up Time .....	11	11	— Seconds
Maximum Heater-Cathode Voltage			
Heater Negative with Respect to Cathode			
Total DC and Peak.....			200 Volts
Heater Positive with Respect to Cathode			
DC .....			100 Volts
Total DC and Peak.....			200 Volts

**DIRECT INTERELECTRODE CAPACITANCES (Shielded)<sup>(1)</sup>**

Grid No. 1 to Plate .....	0.02 Pf
Grid No. 1 to Grid No. 3 .....	0.1 Pf
Grid No. 3 to All Other Electrodes.....	6.1 Pf
Grid No. 1 to Grid No. 2, Grid No. 3, Heater, and Internal Shield and Cathode .....	5.8 Pf
Grid No. 3 to Plate .....	1.7 Pf

**RATINGS (Design Maximum Rating System)**

**FM Detector Service**

Plate Voltage (Max.) .....	330 Volts
Plate Dissipation (Max.) .....	1.7 Watts
Grid No. 3 Voltage (Max.) .....	28 Volts
Grid No. 2 Supply Voltage (Max.) .....	330 Volts
Grid No. 2 Voltage .....	See Rating Chart (Gen. Info. Sec.)
Grid No. 1 Voltage (Positive Bias) (Max.) .....	0 Volt
Grid No. 2 Input	
For $E_{b2}$ up to 165 Volts (Max.).....	1.1 Watts
For $E_{b2}$ Between 165 and 330 Volts.....	See Rating Chart (Gen. Info. Sec.)

**CHARACTERISTICS AND TYPICAL OPERATION**

**Class A1 Amplifier**

Plate Supply Voltage.....	150 Volts
Grid No. 3 Supply Voltage.....	0 Volt
Grid No. 2 Supply Voltage.....	100 Volts
Cathode Bias Resistor .....	560 Ohms
Plate Current .....	1.55 Ma
Grid No. 2 Current .....	1.80 Ma
Transconductance	
Grid No. 1 to Plate .....	1350 $\mu$ mhos
Grid No. 3 to Plate .....	515 $\mu$ mhos
Plate Resistance (Approx.) .....	0.15 Megohm
Grid No. 1 Voltage for $I_b = 10\ \mu\text{a}$ .....	-5.2 Volts
Grid No. 3 Voltage for $I_b = 10\ \mu\text{a}$ .....	-4.2 Volts

**NOTE:**

- (1) Shield No. 316 connected to cathode.

## RF AMPLIFIER or OSCILLATOR and MIXER

## 6DT8 12DT8

### High Mu Twin Triode

Construction ..... Miniature T-6½  
 Base ..... Button 9 Pin, E9-1  
 Basing<sup>(1)</sup> ..... 9DE  
 Outline ..... 6-2  
 Maximum Diameter ..... 0.875 In.  
 Maximum Seated Height ..... 1.937 In.  
 Maximum Overall Height ..... 2.187 In.

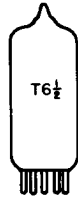
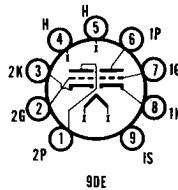

### ELECTRICAL DATA HEATER OPERATION

Heater Voltage.....	<b>12DT8</b>	<b>6DT8</b>
Heater Current.....	12.6	6.3 Volts
Maximum Heater-Cathode Voltage	150	300 Ma
Heater Negative with Respect to Cathode		
Total DC and Peak.....		200 Volts
Heater Positive with Respect to Cathode		
DC.....		100 Volts
Total DC and Peak.....		200 Volts

### DIRECT INTERELECTRODE CAPACITANCES (Shielded)

	Section No. 1 <sup>(1)</sup>	Section No. 2
Grid to Plate .....	1.6	1.6 Pf
Input: g to (k + h + IS) .....	2.7	2.7 Pf
Output: p to (k + h + IS) .....	1.6	1.6 Pf
Heater to Cathode .....	3.0	3.0 Pf

### Grounded Grid Operation

Input: k to (g + h + IS) .....	5.3 Pf
Output: p to (g + h + IS) .....	2.8 Pf

### RATINGS (Design Center Rating System)

Plate Voltage (Max.) .....	300 Volts
Plate Dissipation (Max.) .....	2.5 Watts
Negative Grid Voltage (Max.) .....	50 Volts
Grid Circuit Resistance	
Fixed Bias (Max.) .....	0.25 Megohm
Self Bias (Max.) .....	1.0 Megohms

### CHARACTERISTICS AND TYPICAL OPERATION

#### Class A1 Amplifier—Each Section

Plate Voltage .....	100	250 Volts
Cathode Bias Resistor .....	270	200 Ohms
Plate Current .....	3.7	10.0 Ma
Transconductance .....	4000	5500 μmhos
Amplification Factor .....	60	60
Plate Resistance.....	15,000	10,900 Ohms
Ec for Ib = 10 μa (Approx.).....	-5	-12 Volts

### NOTES:

- (1) Section No. 1 connects to Pins 6, 7, and 8.
- (2) An internal shield is connected to Pin No. 9 to provide isolation between the two sections.

## Color Television Type UHF OSCILLATOR

## 6DV4 2DV4

### Medium Mu Triode

Construction ..... Nuvistor, Metal  
 Base...Ceramic Wafer, Twelvar 7 Pin, E7-83  
 Basing ..... 12EA  
 Outline .....

Maximum Diameter .....0.440 In.  
 Maximum Seated Height .....0.625 In.  
 Maximum Overall Height .....0.800 In.

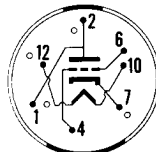

12EA

**ELECTRICAL DATA  
HEATER OPERATION**

	2DV4	6DV4
Heater Voltage.....	2.1	6.3 Volts
Heater Current.....	450	135 Ma
Heater Warm-up Time.....	8	— Seconds
Maximum Heater-Cathode Voltage.....	—	100 Volts

**DIRECT INTERELECTRODE CAPACITANCES**

Grid to Plate.....	1.8 Pf
Grid to Cathode, Heater, and Shell.....	4.4 Pf
Plate to Cathode, Heater, and Shell.....	1.9 Pf
Plate to Cathode.....	0.25 Pf
Heater to Cathode.....	1.4 Pf
Grid to Cathode.....	3.7 Pf

**RATINGS (Design Maximum Rating System)**
**Class A1 Amplifier**

Plate Supply Voltage (Max.) <sup>(1)</sup> .....	300 Volts
Plate Voltage (Max.).....	125 Volts
Grid Voltage.....	
Negative Bias (Max.).....	-55 Volts
Peak Positive Bias (Max.).....	2 Volts
Plate Dissipation (Max.).....	1 Watt
Cathode Current (Max.).....	15 Ma
Grid Circuit Resistance <sup>(2)</sup> .....	
Fixed Bias (Max.).....	0.1 Megohm
Cathode Bias (Max.).....	0.2 Megohm

**CHARACTERISTICS AND TYPICAL OPERATION**

Plate Supply Voltage.....	75 Volts
Cathode Bias Resistor.....	100 Ohms
Amplification Factor.....	35
Plate Resistance (Approx.).....	3100 Ohms
Transconductance.....	11,500 $\mu$ mhos
Grid Voltage for $I_b = 10 \mu$ a.....	-7 Volts
Plate Current.....	10.5 Ma

**Oscillator at 950 MHz**

Plate Voltage.....	60 Volts
Grid Voltage.....	-2 Volts
Grid Resistor.....	5600 Ohms
Plate Current.....	8 Ma
Grid Current.....	350 $\mu$ a

**NOTES:**

- (1) A plate supply voltage of 300 volts may be used provided that a sufficiently large resistor is used in the plate circuit to limit the plate dissipation to one watt under any condition of operation.
- (2) For operation at shell temperatures up to 135° C.

**6DW4A**

12DW4A, 17DW4A

Color Television Type

**DAMPER**
**Heater-Cathode Diode**

Construction.....Novar T-9  
 Base.....Novar Button 9 Pin, E9-75  
 Basing<sup>(1)</sup>.....9HP  
 Outline

Maximum Diameter.....1.188 In.  
 Maximum Seated Height.....3.030 In.  
 Maximum Overall Height.....3.410 In.

**ELECTRICAL DATA  
HEATER OPERATION**

	17DW4A	12DW4A	6DW4A
Heater Voltage.....	16.8	12.6	6.3 Volts
Heater Current.....	450	600	1200 Ma
Heater Warm-up Time.....	11	11	— Seconds
Maximum Heater-Cathode Voltage.....			
Heater Negative with Respect to Cathode.....			
DC.....			900 Volts
Total DC and Peak.....			5500 Volts
Heater Positive with Respect to Cathode.....			
DC.....			100 Volts
Total DC and Peak.....			300 Volts

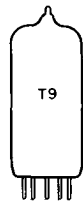
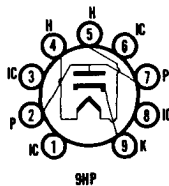

**DIRECT INTERELECTRODE CAPACITANCES (Unshielded)**

Heater to Cathode .....	2.8 Pf
Plate to Cathode and Heater.....	6.5 Pf
Cathode to Plate and Heater.....	9.0 Pf

**RATINGS (Design Maximum Rating System)**

**Damper Service**

Peak Inverse Plate Voltage (Max.) <sup>(2)</sup> .....	5500 Volts
Plate Dissipation (Max.) .....	8.5 Watts
Steady State Peak Current (Max.) .....	1300 Ma
DC Plate Current (Max.) .....	250 Ma

**CHARACTERISTICS AND TYPICAL OPERATION**

Tube Voltage Drop for Ib = 350 Ma .....	25 Volts
---	----------

**NOTES:**

- (1) Pins 1, 3, 6, and 8 should not be used as tie points.
- (2) For operation in a 525 line, 30 frame system as described in "Standards of Good Engineering Practice for Television Broadcast Stations; Federal Communications Commission," the duty cycle of the voltage pulse must not exceed 15% of one horizontal scanning cycle.

*Color Television Type*

**DAMPER**

**6DW4B**

**Heater-Cathode Diode**

Construction .....Novar T-9  
 Base .....Novar Button 9-Pin, E9-89  
 (Exhaust Tip on Base)  
 Basing .....9HP  
 Outline

Maximum Diameter .....1.188 In.  
 Maximum Seated Height .....2.625 In.  
 Maximum Overall Height .....3.005 In.

The 6DW4B is identical to the 6DW4A except for base with exhaust tip at bottom and shorter bulb.

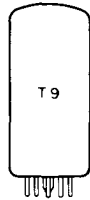
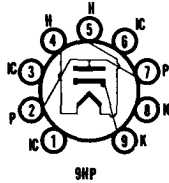

*Color Television Type*

**KEYED AGC, SYNC SEP./AMP. (T)  
VIDEO AMPLIFIER (P)**

**6DX8/ECL84**  
10DX8/LCL84

**Triode and Pentode**

Construction .....Miniature T-6½  
 Base .....Button 9 Pin, E9-1  
 Basing .....9HX  
 Outline

Maximum Diameter .....0.875 In.  
 Maximum Seated Height .....2.375 In.  
 Maximum Overall Height .....2.625 In.

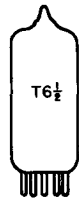
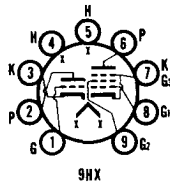

**ELECTRICAL DATA**

**HEATER OPERATION**

Heater Voltage.....	10DX8/ LCL84	6DX8/ECL84
Heater Current .....	10.2	6.3 Volts
Maximum Heater-Cathode Voltage	450	720 Ma
Heater Negative with Respect to Cathode		
DC and Peak.....		200 Volts
Heater Positive with Respect to Cathode		
DC and Peak.....		200 Volts

**DIRECT INTERELECTRODE CAPACITANCES**

**Pentode Section**

G1 to All Elements (Except Plate).....	9.0 Pf
Plate to All Elements (Except Grid No. 1) .....	4.5 Pf
Plate to Grid No. 1 (Max.).....	0.1 Pf
Grid No. 1 to Heater (Max.) .....	0.1 Pf

**Triode Section**

G1 to All Elements (Except Plate).....	4.0 Pf
Plate to All Elements (Except Grid No. 1) .....	2.3 Pf
Plate to Grid No. 1 .....	2.7 Pf
Grid to Heater (Max.) .....	0.1 Pf

**Coupling**

Triode Plate to Pentode Grid No. 1 (Max.) .....	0.01 Pf
Triode Grid No. 1 to Pentode Grid No. 1 (Max.) .....	0.01 Pf

**RATINGS (Design Center Rating System)**

**Pentode Section**

Plate Supply Voltage (Max.) .....	550 Volts
Plate Voltage (Max.) .....	300 Volts
Grid No. 2 Supply Voltage (Max.) .....	550 Volts
Grid No. 2 Voltage (Max.) .....	300 Volts
Cathode Current (Max.).....	40 Ma
Plate Dissipation (Max.) .....	4 Watts
Grid No. 2 Dissipation (Max.) .....	1.7 Watts
Grid No. 1 Circuit Resistance	
Fixed Bias (Max.) .....	1 Megohm
Cathode Bias (Max.) .....	2 Megohms

**Triode Section**

Plate Supply Voltage (Max.) .....	550 Volts
Plate Voltage (Max.) .....	300 Volts
Cathode Current (Max.) .....	12 Ma
Plate Dissipation (Max.) .....	1 Watt
Grid No. 1 Circuit Resistance	
Fixed Bias (Max.) .....	1 Megohm
Cathode Bias (Max.) .....	3 Megohms

**CHARACTERISTICS AND TYPICAL OPERATION**

**Pentode Section**

Plate Voltage .....	170	200	220 Volts
Grid No. 2 Voltage .....	170	200	220 Volts
Grid No. 1 Voltage .....	-2.1	-2.9	-3.4 Volts
Plate Current .....	18	18	18 Ma
Grid No. 2 Current .....	3	3	3 Ma
Transconductance .....	11,000	10,400	10,000 $\mu$ mhos
Plate Resistance.....	100,000	130,000	150,000 Ohms
Amplification Factor (Grid No. 1 to Grid No. 2).....	36	36	36

**Triode Section**

Plate Voltage .....	200 Volts
Grid No. 1 Voltage .....	-1.7 Volts
Plate Current .....	3 Ma
Transconductance .....	4000 $\mu$ mhos
Amplification Factor .....	65

**6DZ4/6AF4A**

2DZ4/2AF4B  
3DZ4/3AF4B

Color Television Type

**UHF OSCILLATOR**

**Medium Mu Triode**

Construction ..... Miniature T-5½  
Base ..... Button 7 Pin, E7-1  
Basing ..... 7DK  
Outline ..... 5-1  
Maximum Diameter ..... 0.750 In.  
Maximum Seated Height ..... 1.500 In.  
Maximum Overall Height ..... 1.750 In.

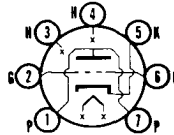

7 DK

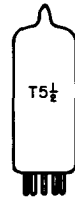

**ELECTRICAL DATA**

**HEATER OPERATION**

	2DZ4/2AF4B	3DZ4/3AF4B	6DZ4/6AF4A
Heater Voltage.....	2.35	3.2	6.3 Volts
Heater Current .....	600	450	225 Ma
Heater Warm-up Time .....	11	11	— Seconds
Maximum Heater-Cathode Voltage			
Heater Negative with Respect to Cathode			
Total DC and Peak.....	180	180	50 Volts
Heater Positive with Respect to Cathode			
DC .....	100	100	25 Volts
Total DC and Peak.....	180	180	50 Volts

**DIRECT INTERELECTRODE CAPACITANCES (Shielded)**

Grid to Plate .....	1.8 Pf
Input: g to (h + k + ES) .....	2.2 Pf
Output: p to (h + k + ES) .....	1.3 Pf

**RATINGS (Design Maximum Rating System)**

**UHF Oscillator Service**

Plate Voltage (Max.) .....	135 Volts
Plate Dissipation (Max.) .....	2.3 Watts
Negative Grid Voltage (Max.) .....	50 Volts
Grid Current (Max.) .....	2 Ma
Cathode Current (Max.) .....	20 Ma

**CHARACTERISTICS AND TYPICAL OPERATION**

**Class A1 Amplifier**

Plate Supply Voltage .....	80 Volts
Plate Resistor .....	2700 Ohms
Plate Current .....	15 Ma
Transconductance .....	6700 $\mu$ mhos
Amplification Factor .....	14
Plate Resistance (Approx.) .....	2000 Ohms
Ec for Ib = 20 $\mu$ a (Approx.) .....	-11 Volts

**Oscillator at 1000 MHz<sup>(1)</sup>**

Plate Supply Voltage .....	135 Volts
Plate Resistor .....	2700 Ohms
Grid Resistor .....	10,000 Ohms
Plate Current .....	15.5 Ma
Grid Current (Approx.) .....	800 $\mu$ a

**NOTE:**

(1) Measured in JEDEC Standard Oscillator No. 400.



**Beam Triode**

Construction .....	Compactron T-12
Base .....	Button 12 Pin, E12-74
Top Cap .....	C1-34
Basing .....	12FA
Outline .....	12-90
Maximum Diameter .....	1.563 In.
Maximum Seated Height .....	4.000 In.
Maximum Overall Height .....	4.375 In.

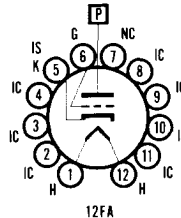

**ELECTRICAL DATA**

**HEATER OPERATION**

Heater Voltage .....	6.3 Volts
Heater Current .....	200 Ma
Maximum Heater-Cathode Voltage .....	
Heater Positive with Respect to Cathode .....	Not Recommended
Heater Negative with Respect to Cathode .....	200 Volts

**DIRECT INTERELECTRODE CAPACITANCES (Unshielded)**

Grid to Plate .....	0.036 Pf
Input: g to (h + k) .....	1.9 Pf
Output: p to (h + k) .....	0.63 Pf

**RATINGS (Design Maximum Rating System)**

Plate-Supply Voltage, Unregulated (Max.) .....	60,000 Volts
Plate Voltage (Max.) .....	27,000 Volts
Negative DC Grid Voltage (Max.) .....	135 Volts
Peak Negative Grid Voltage (Max.) <sup>(1)</sup> .....	440 Volts
Plate Dissipation (Max.) .....	30 Watts
DC Plate Current (Max.) .....	1.6 Ma
Grid Circuit Resistance (Max.) <sup>(2)</sup> .....	3.0 Megohms

**CHARACTERISTICS AND TYPICAL OPERATION**

**Shunt Voltage Regulator Service**

Unregulated DC Supply Voltage .....	36,000 Volts
Equivalent Resistance of Unregulated Supply .....	11 Megohms
DC Reference Voltage .....	200 Volts
Equivalent Resistance of Reference Supply .....	1000 Ohms
Effective Grid-Plate Transconductance .....	200 $\mu$ mhos
DC Plate Current for Zero Load Current .....	1000 $\mu$ a

DC Plate Current for Load Current of 1 Ma .....	45 $\mu$ a
Regulated DC Output Voltage at Zero Load Current .....	25,000 Volts
Regulated DC Output Voltage at Load Current of 1 Ma.....	24,500 Volts

**NOTES:**

- (1) Peak value for duration of 20 seconds maximum during equipment warm-up.
- (2) With flyback transformer high-voltage supply.

**WARNING:**

X-ray radiation shielding may be necessary to protect against possible danger of personal injury from prolonged exposure at close range if this tube is operated higher than 16,000 volts.



**Double Dissimilar Triode**

Construction .....	T-9
Base .....	B8-6 or B8-251
Basing .....	.8BD
Outline .....	9-5
Maximum Diameter .....	1.281 In.
Maximum Seated Height .....	2.439 In.
Maximum Overall Height .....	3.000 In.

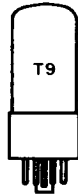
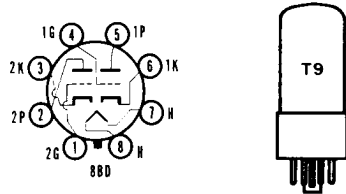

**ELECTRICAL DATA**

**HEATER OPERATION**

	15EA7	6EA7
Heater Voltage.....	14.8	6.3 Volts
Heater Current .....	450	1050 Ma
Heater Warm-up Time .....	11	— Seconds
<b>Maximum Heater-Cathode Voltage</b>		
Heater Negative with Respect to Cathode		
Total DC and Peak.....		200 Volts
Heater Positive with Respect to Cathode		
DC .....		100 Volts
Total DC and Peak.....		200 Volts

**DIRECT INTERELECTRODE CAPACITANCES (Unshielded)**

	Section No. 1 <sup>(3)</sup>	Section No. 2
Grid to Plate .....	4.0	8 Pf
Input: g to (h + k) .....	2.2	6 Pf
Output: p to (h + k) .....	0.6	1.3 Pf

**RATINGS (Design Maximum Rating System)**

**Vertical Deflection Oscillator and Amplifier<sup>(1)</sup>**

	Section No. 1 <sup>(3)</sup> Oscillator	Section No. 2 Amplifier
DC Plate Voltage (Max.) .....	350	550 Volts
Peak Positive Pulse Plate Voltage (Abs. Max.).....	—	1500 Volts
Peak Negative Pulse Grid Voltage (Max.) .....	400	250 Volts
Plate Dissipation (Max.) <sup>(2)</sup> .....	1.0	10 Watts
Average Cathode Current (Max.).....	22	50 Ma
Peak Cathode Current (Max.) .....	77	175 Ma
Grid Circuit Resistance		
Fixed Bias (Max.) .....	1.0	1.0 Megohm
Self Bias (Max.) .....	2.2	2.2 Megohms

**CHARACTERISTICS AND TYPICAL OPERATION**

	Section No. 1 <sup>(3)</sup>	Section No. 2
Plate Voltage .....	250	175 Volts
Grid No. 1 Voltage .....	-3	-25 Volts
Plate Current .....	2.0	40 Ma
Transconductance .....	2200	6000 $\mu$ mhos
Amplification Factor .....	66	5.5
Plate Resistance (Approx.) .....	30,000	920 Ohms
Ec for Ib = 20 $\mu$ a (Approx.).....	-5.3	— Volts
Ec for Ib = 200 $\mu$ a (Approx.).....	—	-45 Volts

**INSTANTANEOUS ZERO BIAS PLATE VALUES (Section No. 2)**

Eb = 60 V, Ec = 0  
Ib = 100 Ma



**NOTES:**

- (1) For operation in a 525 line, 30 frame system as described in "Standards of Good Engineering Practice for Television Broadcast Stations; Federal Communications Commission," the duty cycle of the voltage pulse must not exceed 15% of one horizontal scanning cycle.
- (2) In stages operating with grid-leak bias, an adequate bias resistor or other suitable means is required to protect the tube in the absence of excitation.
- (3) Section No. 1 connects to Pins 4, 5, and 6.

*Color Television Type*

**VHF OSCILLATOR and MIXER  
or GENERAL PURPOSE AMPLIFIER**

**6EA8/6GH8A**  
5EA8, 5GH8, 5GH8A,  
9EA8, 9GH8A, 19EA8

**Medium Mu Triode and Sharp Cutoff Pentode**

Construction ..... Miniature T-6½  
 Base ..... Button 9 Pin, E9-1  
 Basing ..... 9AE  
 Outline ..... 6-2  
 Maximum Diameter ..... 0.875 In.  
 Maximum Seated Height ..... 1.937 In.  
 Maximum Overall Height ..... 2.187 In.

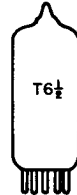
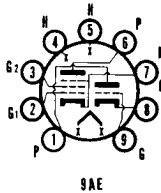

**ELECTRICAL DATA  
HEATER OPERATION**

	19EA8	9EA8 9GH8A	5EA8 5GH8 5GH8A	6EA8/6GH8A
Heater Voltage.....	18.9	9.5	4.7	6.3 Volts
Heater Current .....	150	300	600	450 Ma
Heater Warm-up Time .....	11	11	11	11 Seconds
Maximum Heater-Cathode Voltage				
Heater Negative with Respect to Cathode				
Total DC and Peak.....				200 Volts
Heater Positive with Respect to Cathode				
DC .....				100 Volts
Total DC and Peak.....				200 Volts

**DIRECT INTERELECTRODE CAPACITANCES (Shielded)**

<b>Triode Section</b>		
Grid to Plate .....		1.7 Pf
Input .....		3.2 Pf
Output .....		1.9 Pf
Heater to Cathode .....		3.0 Pf
<b>Pentode Section</b>		
Grid No. 1 to Plate (Max.).....		0.01 Pf
Input .....		5.0 Pf
Output .....		3.4 Pf
Heater to Cathode .....		3.0 Pf

**RATINGS (Design Maximum Rating System)**

	Triode Section	Pentode Section	Pentode Section Horiz. Defl. Osc. (1)
Plate Voltage (Max.) .....	330	330	350 Volts
Grid No. 2 Supply Voltage (Max.) .....	—	330	330 Volts
Grid No. 2 Voltage .....	See Rating Chart (Gen. Info. Sec.)		
Positive Grid No. 1 Voltage (Max.) .....	—	0	0 Volt
Peak Negative Pulse Grid Voltage (Max.) .....	0	—	175 Volts
Average Cathode Current (Max.).....	—	—	20 Ma
Peak Cathode Current (Max.).....	—	—	300 Ma
Plate Dissipation (Max.).....	2.5	3.1	2.5 Watts
Grid No. 2 Dissipation (Max.) .....	—	0.55	0.55 Watt
Maximum Grid No. 1 Circuit Resistance			
Fixed Bias .....	2.2	—	2.2 Megohms
Self Bias .....	2.2	—	2.2 Megohms

**CHARACTERISTICS AND TYPICAL OPERATION**

	Triode Section	Pentode Section
<b>Class A1 Amplifier</b>		
Plate Voltage .....	150	125 Volts
Grid No. 2 Voltage .....	—	125 Volts
Grid No. 1 Voltage .....	—	-1.0 Volts
Cathode Bias Resistor .....	56	— Ohms
Plate Current .....	18	12 Ma
Grid No. 2 Current .....	—	4 Ma

Transconductance .....	8500	6400 $\mu$ mhos
Amplification Factor .....	40	—
Plate Resistance (Approx.) .....	5000	200,000 Ohms
$E_{c1}$ for $I_b = 10 \mu$ a (Approx.) .....	-12	-9 Volts

**NOTE:**

- (1) For operation in a 525 line, 30 frame system as described in "Standards of Good Engineering Practice for Television Broadcast Stations; Federal Communications Commission," the duty cycle of the voltage pulse must not exceed 15% of one horizontal scanning cycle.

**AVERAGE PLATE CHARACTERISTICS  
(Pentode Section)**

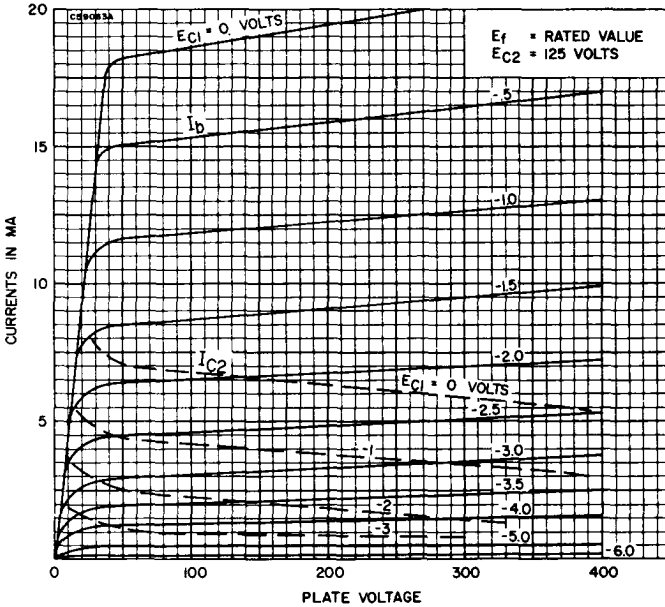

**AVERAGE PLATE CHARACTERISTICS  
(Triode Section)**

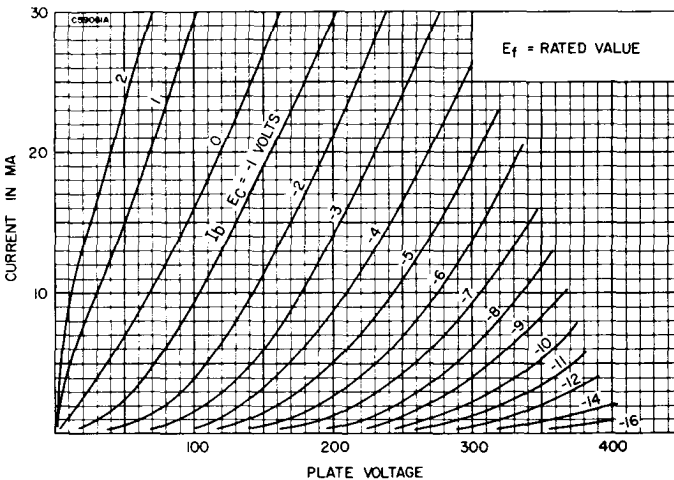

Color Television Type

**SYNC SEP./CLIPPER (T)  
VIDEO AMPLIFIER (P)**

**6EB8**

8EB8, 10EB8

**High Mu Triode and  
Sharp Cutoff Pentode**

Construction ..... Miniature T-6½  
Base ..... Button 9 Pin, E9-1  
Basing ..... 9DX  
Outline ..... 6-3  
Maximum Diameter ..... 0.875 In.  
Maximum Seated Height ..... 2.375 In.  
Maximum Overall Height ..... 2.625 In.

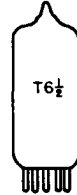
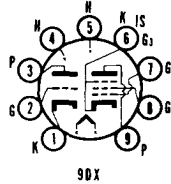

**ELECTRICAL DATA**

**HEATER OPERATION**

	10EB8	8EB8	6EB8
Heater Voltage.....	10.5	8.0	6.3 Volts
Heater Current .....	450	600	750 Ma
Heater Warm-up Time .....	11	11	— Seconds
Maximum Heater-Cathode Voltage			
Heater Negative with Respect to Cathode			
Total DC and Peak.....			200 Volts
Heater Positive with Respect to Cathode			
DC .....			100 Volts
Total DC and Peak.....			200 Volts

**DIRECT INTERELECTRODE CAPACITANCES (Unshielded)**

**Triode Section**

Grid to Plate .....	4.4 Pf
Input: g to (h + k) .....	2.4 Pf
Output: p to (h + k) .....	0.36 Pf

**Pentode Section**

Grid No. 1 to Plate (Max.) .....	0.1 Pf
Input: g1 to (h + k + g2 + g3 + IS).....	11 Pf
Output: p to (h + k + g2 + g3 + IS).....	4.2 Pf

**Coupling**

Triode Grid to Pentode Plate (Max.) .....	0.018 Pf
Pentode Grid No. 1 to Triode Plate (Max.) .....	0.005 Pf
Pentode Plate to Triode Plate (Max.) .....	0.17 Pf

**RATINGS (Design Maximum Rating System)**

	Triode Section	Pentode Section
Plate Voltage (Max.) .....	330	330 Volts
Grid No. 2 Supply Voltage (Max.) .....	—	330 Volts
Grid No. 2 Voltage .....	See Rating Chart (Gen. Info. Sec.)	
Positive Grid No. 1 Voltage (Max.) .....	0	0 Volt
Plate Dissipation (Max.) .....	1.0	5.0 Watts
Grid No. 2 Dissipation (Max.) .....	—	1.1 Watts
Grid No. 1 Circuit Resistance		
Fixed Bias (Max.) .....	0.5	0.25 Megohm
Cathode Bias (Max.) .....	1.0	1.0 Megohm

**CHARACTERISTICS AND TYPICAL OPERATION**

	Triode Section	Pentode Section
Plate Voltage .....	250	200 Volts
Grid No. 2 Voltage .....	—	125 Volts
Grid No. 1 Voltage .....	-2	— Volts
Cathode Bias Resistor .....	—	68 Ohms
Plate Current .....	2	25 Ma
Grid No. 2 Current .....	—	7 Ma
Transconductance .....	2700	12,500 μmhos
Amplification Factor .....	100	—
Plate Resistance (Approx.) .....	37,000	75,000 Ohms
Ec1 for Ib = 100 μa (Approx.) .....	—	-9 Volts
Ec1 for Ib = 20 μa (Approx.) .....	-5	— Volts

**INSTANTANEOUS PLATE KNEE CHARACTERISTICS (Pentode Section)**

Eb = 45 Volts, Ec2 = 125 Volts and Ec1 = 0 Volt  
Ib = 40 Ma and Ic2 = 15 Ma

# 6EF4

# SHUNT REGULATOR

### Beam Power Triode

Construction ..... Compactron T-12  
 Base ..... Button 12 Pin, E12-74  
 Top Cap ..... C1-34  
 Basing ..... 12HC  
 Outline ..... 12-90  
     Maximum Diameter ..... 1.563 In.  
     Maximum Seated Height ..... 4.000 In.  
     Maximum Overall Height ..... 4.375 In.

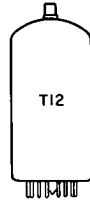
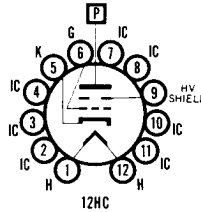

### ELECTRICAL DATA

#### HEATER OPERATION

Heater Voltage .....	6.3 Volts
Heater Current .....	200 Ma
Maximum Heater-Cathode Voltage	
Heater Negative with Respect to Cathode <sup>(1)</sup> .....	450 Volts
Heater Positive with Respect to Cathode .....	Not Recommended

#### DIRECT INTERELECTRODE CAPACITANCES (Unshielded)

Grid to Plate .....	0.03 Pf
Input: g to (h + k) .....	2.0 Pf
Output: p to (h + k) .....	0.8 Pf

#### RATINGS (Design Maximum Rating System)

Plate-Supply Voltage (Unregulated) .....	60,000 Volts
Plate Voltage .....	27,000 Volts
Negative DC Grid Voltage .....	135 Volts
Peak Negative Grid Voltage <sup>(2)</sup> .....	440 Volts
Plate Dissipation .....	40 Watts
DC Plate Current .....	1.6 Ma
Grid-Circuit Resistance <sup>(3)</sup> .....	3.0 Megohms

#### CHARACTERISTICS AND TYPICAL OPERATION

##### Shunt Voltage Regulator Service

Unregulated DC Supply Voltage .....	36,000 Volts
Equivalent Resistance of Unregulated Supply .....	11 Megohms
DC Reference Voltage .....	200 Volts
Equivalent Resistance of Reference Supply .....	1000 Ohms
Effective Grid-Plate Transconductance .....	200 $\mu$ mhos
DC Plate Current for Zero Load Current .....	1000 $\mu$ a
DC Plate Current for Load Current of 1 Ma .....	45 $\mu$ a
Regulated DC Output Voltage at Zero Load Current .....	25,000 Volts
Regulated DC Output Voltage at Load Current of 1 Ma .....	24,500 Volts

#### NOTES:

- (1) Sufficient impedance (1000 Ohms is suggested) should be in series with the cathode to limit the cathode current under prolonged heater-cathode short-circuit conditions to 450 Ma. This protective impedance will minimize the danger of heater burnout in case of a momentary heater-cathode arc within the tube.
- (2) Peak value for duration of 20 seconds maximum during equipment warm-up.
- (3) With flyback transformer high-voltage supply.

#### WARNING:

X-ray radiation shielding may be necessary to protect against possible danger of personal injury from prolonged exposure at close range if this tube is operated higher than 16,000 volts.

# 6EH5

12EH5, 25EH5,  
35EH5A, 50EH5A

# AUDIO POWER AMPLIFIER

### Beam Power Pentode

Construction ..... Miniature T-5½  
 Base ..... Button 7 Pin, E7-1  
 Basing ..... 7CV  
 Outline ..... 5-3  
     Maximum Diameter ..... 0.750 In.  
     Maximum Seated Height ..... 2.375 In.  
     Maximum Overall Height ..... 2.625 In.

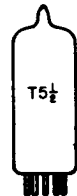
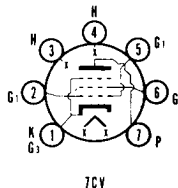

**ELECTRICAL DATA  
HEATER OPERATION**

	50EH5A	35EH5A	25EH5	12EH5	6EH5
Heater Voltage.....	50	35	25	12.6	6.3 Volts
Heater Current.....	150	150	300	600	1200 Ma
Heater Warm-up Time.....	17	17	—	11	— Seconds
Maximum Heater-Cathode Voltage					
Heater Negative with Respect to Cathode					
Total DC and Peak.....	200	200	200	300	200 Volts
Heater Positive with Respect to Cathode					
DC.....	100	100	100	100	100 Volts
Total DC and Peak.....	200	200	200	200	200 Volts

**DIRECT INTERELECTRODE CAPACITANCES (Unshielded)**

Grid No. 1 to Plate.....	0.65 Pf
Input: g1 to (k + g3 + g2 + h).....	17 Pf
Output: p to (k + g3 + g2 + h).....	9 Pf

**RATINGS (Design Maximum Rating System)**

**Class A1 Amplifier**

Plate Voltage (Max.).....	150 Volts	
Grid No. 2 Voltage (Max.).....	130 Volts	
Positive Grid No. 1 Voltage (Max.).....	0 Volt	
Plate Dissipation (Max.).....	5.5 Watts	
Grid No. 2 Input (Max.).....	2.00 Watts	
Grid No. 1 Circuit Resistance		
Fixed Bias (Max.).....	0.1 Megohms	
Cathode Bias (Max.).....	0.5 Megohms	
Bulb Temperature at Hottest Point (Max.).....	220 °C	

**CHARACTERISTICS AND TYPICAL OPERATION**

	Push-Pull AB1 Amp.	A1 Amp.
Plate Voltage.....	140	110 Volts
Grid No. 2 Voltage.....	120	115 Volts
Cathode Resistor.....	68	62 Ohms
Peak AF Grid No. 1 Voltage.....	4.7	3 Volts
Zero Signal Plate Current.....	47	42 Ma
Maximum Signal Plate Current.....	51	42 Ma
Zero Signal Grid No. 2 Current.....	11	11.5 Ma
Maximum Signal Grid No. 2 Current.....	17.7	14.5 Ma
Transconductance.....	—	14,600 μmhos
Plate Resistance (Approx.).....	—	11,000 Ohms
Load Resistance.....	6000 <sup>(1)</sup>	3000 Ohms
Maximum Signal Power Output.....	3.8	1.4 Watts
Total Harmonic Distortion.....	5	7 Percent

**NOTE:**

(1) Plate to Plate.

Color Television Type

**VHF/IF AMPLIFIER**

**6EH7/EF183**

3EH7/XF183, 4EH7

**Semi-Remote Cutoff Pentode**

Construction.....	Miniature T-6½	
Base.....	Button 9 Pin, E9-1	
Basing.....	.9AQ	
Outline		
Maximum Diameter.....	0.875 In.	
Maximum Seated Height.....	2.156 In.	
Maximum Overall Height.....	2.406 In.	

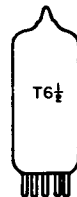
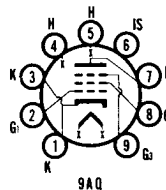

**ELECTRICAL DATA  
HEATER OPERATION**

	3EH7/XF183	4EH7	6EH7/EF183
Heater Voltage.....	3.4	4.4	6.3 Volts
Heater Current.....	600	450	300 Ma
Heater Warm-up Time.....	11	11	— Seconds
Maximum Heater-Cathode Voltage			
Heater Negative with Respect to Cathode			
Total DC and Peak.....	150 Volts		
Heater Positive with Respect to Cathode			
Total DC and Peak.....	150 Volts		

**DIRECT INTERELECTRODE CAPACITANCES (Unshielded)**

Grid No. 1 to Plate (Max.).....	0.005 Pf
Input: g1 to (h + k + g2 + g3 + IS).....	9 Pf
Output: p to (h + k + g2 + g3 + IS).....	3 Pf

**RATINGS (Design Maximum Rating System)**

Plate Voltage with Ib = 0 Ma (Max.) .....	550 Volts
Plate Voltage (Max.) .....	275 Volts
Grid No. 2 Voltage with Ic2 = 0 Ma (Max.) .....	550 Volts
Grid No. 2 Voltage (Max.) .....	275 Volts
Plate Dissipation (Max.) .....	2.8 Watts
Grid No. 2 Dissipation (Max.) .....	0.75 Watt
Cathode Current (Max.).....	22 Ma
Grid No. 1 Circuit Resistance (Max.) .....	1.0 Megohm

**CHARACTERISTICS AND TYPICAL OPERATION**

Plate Voltage .....	200 Volts
Grid No. 3 Voltage .....	0 Volt
Grid No. 2 Voltage .....	90 Volts
Grid No. 1 Voltage .....	-2 Volts
Plate Current .....	12 Ma
Grid No. 2 Current .....	4.5 Ma
Transconductance .....	12,500 $\mu$ mhos
Plate Resistance (Approx.) .....	0.5 Megohm
Grid No. 1 Impedance at 40 MHz <sup>(1)</sup> .....	30,000 Ohms
Plate Voltage .....	200 Volts
Grid No. 3 Voltage .....	0 Volt
Grid No. 2 Supply Voltage.....	200 Volts
Grid No. 2 Series Resistor .....	22,000 Ohms
Grid No. 1 Voltage .....	-19.5      -9.5      -6.5
Transconductance .....	125      625      1250
Ec1 for a Cross Mod. Factor of 1% .....	450      160      100

**NOTE:**

(1) Input damping of tube and typical ceramic socket with both cathode leads returned directly to ground is about 11,000 Ohms.

**AVERAGE TRANSFER CHARACTERISTICS**

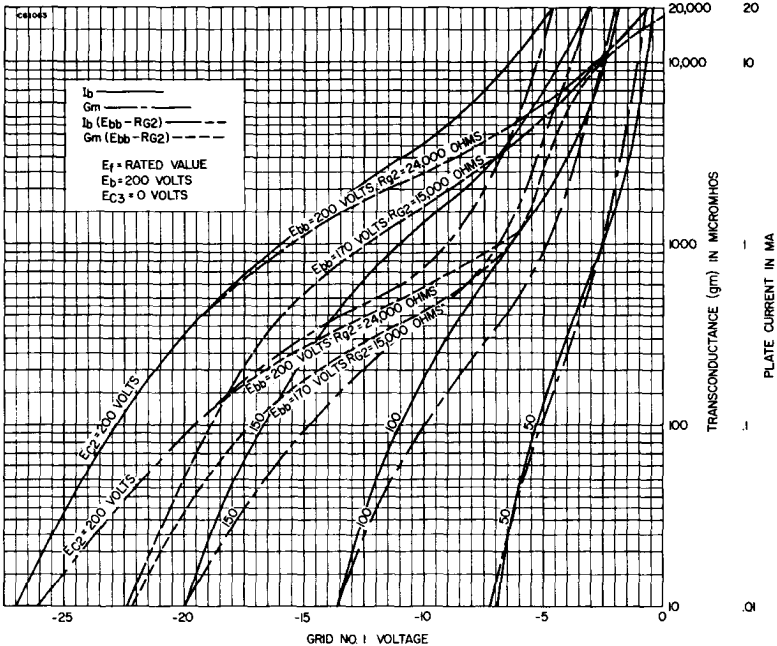

**AVERAGE PLATE CHARACTERISTICS**

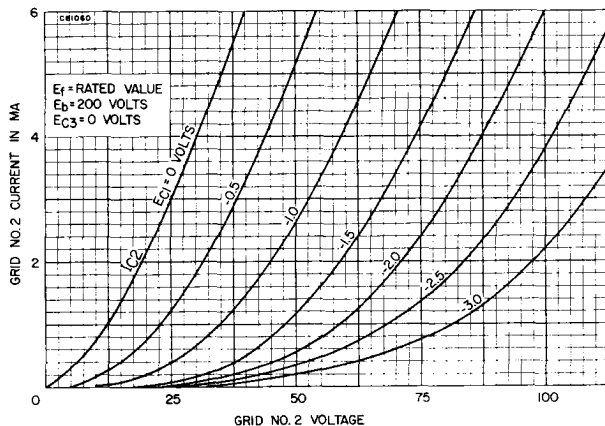

Color Television Type  
**IF AMPLIFIER**

**6EJ7/EF184**  
3EJ7/XF184, 4EJ7

**Sharp Cutoff Pentode**

- Construction ..... Miniature T-6½
- Base ..... Button 9 Pin, E9-1
- Basing ..... 9AQ
- Outline
  - Maximum Diameter ..... 0.875 In.
  - Maximum Seated Height ..... 2.156 In.
  - Maximum Overall Height ..... 2.406 In.

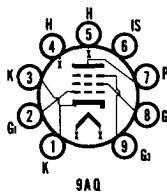

**ELECTRICAL DATA**  
**HEATER OPERATION**

	3EJ7/XF184	4EJ7	6EJ7/EF184
Heater Voltage.....	3.4	4.4	6.3 Volts
Heater Current.....	600	450	300 Ma
Heater Warm-up Time.....	11	11	— Seconds
Maximum Heater-Cathode Voltage			150 Volts
Heater Negative with Respect to Cathode			
Total DC and Peak.....			150 Volts
Heater Positive with Respect to Cathode			
Total DC and Peak.....			150 Volts

**DIRECT INTERELECTRODE CAPACITANCES (Unshielded)**

Grid No. 1 to Plate (Max.).....	0.005 Pf
Input: g1 to (h + k + g2 + g3 + IS).....	10 Pf
Output: p to (h + k + g2 + g3 + IS).....	3 Pf

**RATINGS (Design Maximum Rating System)**

Plate Voltage with Ib = 0 Ma (Max.).....	550 Volts
Plate Voltage (Max.).....	275 Volts
Grid No. 2 Voltage with Ic2 = 0 Ma (Max.).....	550 Volts
Grid No. 2 Voltage (Max.).....	275 Volts
Plate Dissipation (Max.).....	2.8 Watts
Grid No. 2 Dissipation (Max.).....	1.0 Watt
Cathode Current (Max.).....	27 Ma
Grid No. 1 Circuit Resistance (Max.).....	1.0 Megohm

**CHARACTERISTICS AND TYPICAL OPERATION**

**Class A1 Amplifier**

Plate Voltage.....	200 Volts
Grid No. 3 Voltage.....	0 Volt

Grid No. 2 Voltage .....	200 Volts
Grid No. 1 Voltage .....	-2.5 Volts
Plate Current .....	10 Ma
Grid No. 2 Current .....	4.1 Ma
Transconductance .....	15,000 $\mu$ mhos
Amplification Factor (G2 to G1) .....	60
Plate Resistance (Approx.) .....	0.35 Megohm
Grid No. 1 Impedance at 40 MHz <sup>(1)</sup> .....	30,000 Ohms

**NOTE:**

(1) Input damping of tube and typical ceramic socket with both cathode leads tied directly to ground is about 10,000 Ohms.

**AVERAGE TRANSFER CHARACTERISTICS**

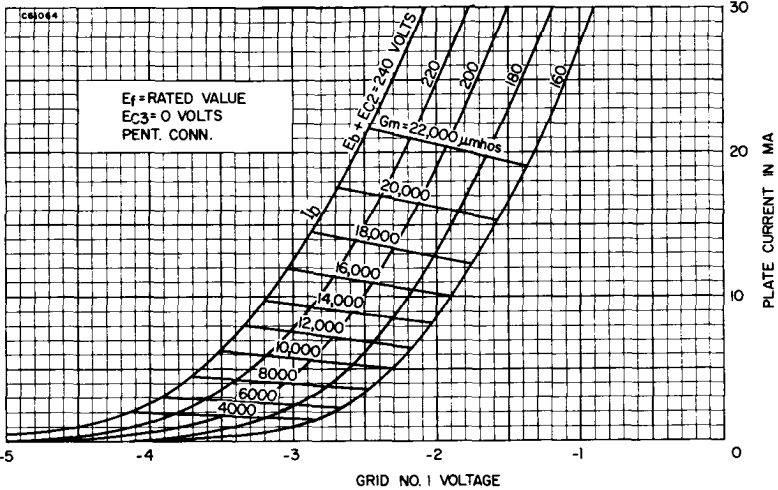

**6EM5**  
8EM5

**VERTICAL DEFLECTION  
AMPLIFIER**

**Beam Power Pentode**

- Construction ..... Miniature T-6½
- Base ..... Button 9 Pin, E9-1
- Basing ..... 9HN
- Outline ..... 6-4
- Maximum Diameter ..... 0.875 In.
- Maximum Seated Height ..... 2.812 In.
- Maximum Overall Height ..... 3.062 In.

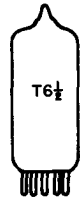
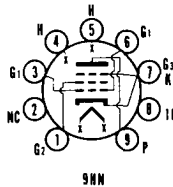

**ELECTRICAL DATA  
HEATER OPERATION**

Heater Voltage.....	<b>8EM5</b> 8.4	<b>6EM5</b> 6.3 Volts
Heater Current .....	600	800 Ma
Heater Warm-up Time .....	11	— Seconds
Maximum Heater-Cathode Voltage Heater Negative with Respect to Cathode Total DC and Peak.....		200 Volts
Heater Positive with Respect to Cathode DC .....		100 Volts
Total DC and Peak.....		200 Volts

**DIRECT INTERELECTRODE CAPACITANCES (Unshielded)**

Grid No. 1 to Plate (Max.).....	0.7 Pf
Input: g1 to (h + k + g2 + g3) .....	10 Pf
Output: p to (h + k + g2 + g3) .....	5.1 Pf



**RATINGS (Design Center Rating System)**

**Vertical Deflection Amplifier<sup>(1)</sup>**

Plate Voltage (Max.) .....	315 Volts
Peak Positive Pulse Plate Voltage (Abs. Max.) .....	2200 Volts
Grid No. 2 Voltage (Max.) .....	285 Volts
Peak Negative Pulse Grid Voltage (Max.) .....	250 Volts
Plate Dissipation (Max.) <sup>(2)</sup> .....	10.0 Watts
Grid No. 2 Input (Max.) <sup>(2)</sup> .....	1.5 Watts
Average Cathode Current (Max.) .....	60 Ma
Peak Cathode Current (Max.) .....	210 Ma
Bulb Temperature (Max.) .....	250 °C
Grid Circuit Resistance	
Fixed Bias (Max.) .....	2.2 Megohms
Cathode Bias (Max.) .....	2.2 Megohms

**CHARACTERISTICS AND TYPICAL OPERATION**

Plate Voltage .....	250 Volts
Grid No. 2 Voltage .....	250 Volts
Grid No. 1 Voltage .....	-18.0 Volts
Plate Current .....	40 Ma
Grid No. 2 Current .....	3.0 Ma
Transconductance .....	5100 $\mu$ mhos
Amplification Factor <sup>(3)</sup> .....	8.7
Ec1 Voltage for Ib = 0.2 Ma (Approx.) .....	-37 Volts

**INSTANTANEOUS PLATE KNEE VALUES**

Eb = 60 V; Ec2 = 250 V; Ec1 = 0 V;

Ib = 180 Ma and Ic2 = 30 Ma

**NOTES:**

- (1) For operation in a 525 line, 30 frame system as described in "Standards of Good Engineering Practice for Television Broadcast Stations; Federal Communications Commission," the duty cycle of the voltage pulse must not exceed 15% of one horizontal scanning cycle.
- (2) In stages operating with grid-leak bias, an adequate bias resistor or other suitable means is required to protect the tube in the absence of excitation.
- (3) Amplification factor measured from Grid No. 1 to Grid No. 2.

Color Television Type

**VERTICAL DEFLECTION  
OSCILLATOR and AMPLIFIER**

**6EM7**

10EM7, 13EM7

**Dissimilar Double Triode**

Construction .....	Octal T-9
Base .....	Octal 8 Pin, B8-58
Basing .....	.8BD
Outline .....	9-37
Maximum Diameter .....	1.188 In.
Maximum Seated Height .....	2.313 In.
Maximum Overall Height .....	2.875 In.

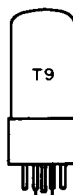
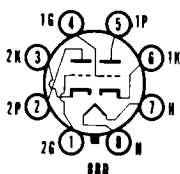

**ELECTRICAL DATA**

**HEATER OPERATION**

	13EM7	10EM7	6EM7
Heater Voltage .....	13	9.7	6.3 Volts
Heater Current .....	450	600	925 Ma
Heater Warm-up Time .....	11	11	— Seconds
Maximum Heater-Cathode Voltage			
Heater Negative with Respect to Cathode			
Total DC and Peak .....			200 Volts
Heater Positive with Respect to Cathode			
DC .....			100 Volts
Total DC and Peak .....			200 Volts

**DIRECT INTERELECTRODE CAPACITANCES (Unshielded)**

	Section No. 1	Section No. 2
Grid to Plate .....	4.8	10 Pf
Input: g to (h + k) .....	2.2	7.0 Pf
Output: p to (h + k) .....	0.6	1.8 Pf

**RATINGS (Design Maximum Rating System)**

**Vertical Deflection Oscillator and Amplifier<sup>(1)</sup>**

	Section No. 1 Oscillator	Section No. 2 Amplifier
DC Plate Voltage (Max.) .....	330	330 Volts
Peak Positive Pulse Plate Voltage (Abs. Max.) .....	—	1500 Volts
Peak Negative Pulse Grid Voltage (Max.) .....	400	250 Volts

Plate Dissipation (Max.) <sup>(2)</sup> .....	1.5	10 Watts
Average Cathode Current (Max.) .....	22	50 Ma
Peak Cathode Current (Max.) .....	77	175 Ma
Grid Circuit Resistance (Self Bias) .....	2.2	2.2 Megohms

**CHARACTERISTICS AND TYPICAL OPERATION**

	Section No. 1 <sup>(3)</sup>	Section No. 2
Plate Voltage .....	250	150 Volts
Grid No. 1 Voltage .....	-3	-20 Volts
Plate Current .....	1.4	50 Ma
Transconductance .....	1600	7200 $\mu$ mhos
Amplification Factor .....	68	5.4
Plate Resistance (Approx.) .....	40,000	750 Ohms
Ec for Ib = 10 $\mu$ a (Approx.) .....	-5.5	— Volts
Ec for Ib = 100 $\mu$ a (Approx.) .....	—	-45 Volts
Ib at Ec = -28 Vdc (Approx.) .....	—	10 Ma

**INSTANTANEOUS PLATE KNEE VALUES (Section No. 2)**

Eb = 60 V; Ec = 0  
Ib = 95 Ma

**NOTES:**

- (1) For operation in a 525 line, 30 frame system as described in "Standards of Good Engineering Practice for Television Broadcast Stations; Federal Communications Commission," the duty cycle of the voltage pulse must not exceed 15% of one horizontal scanning cycle.
- (2) In stages operating with grid-leak bias, an adequate bias resistor or other suitable means is required to protect the tube in the absence of excitation.
- (3) Section No. 1 connects to pins 4, 5, and 6.

# 6EQ7

12EQ7, 20EQ7

## DETECTOR (D) IF AMPLIFIER (P)

**Diode and Sharp Cutoff Pentode**

Construction ..... Miniature T-6 $\frac{1}{2}$   
 Base ..... Button 9 Pin, E9-1  
 Basing ..... 9LQ  
 Outline ..... 6-3  
 Maximum Diameter ..... 0.875 In.  
 Maximum Seated Height ..... 2.375 In.  
 Maximum Overall Height ..... 2.625 In.

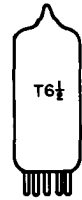
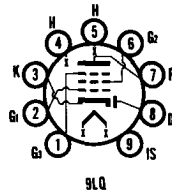

**ELECTRICAL DATA**

**HEATER OPERATION**

	20EQ7	12EQ7	6EQ7
Heater Voltage .....	20	12.6	6.3 Volts
Heater Current .....	100	150	300 Ma
Maximum Heater-Cathode Voltage			
Heater Negative with Respect to Cathode			
Total DC and Peak .....			200 Volts
Heater Positive with Respect to Cathode			
DC .....			100 Volts
Total DC and Peak .....			200 Volts

**DIRECT INTERELECTRODE CAPACITANCES (Unshielded)**

<b>Pentode Section</b>		
Grid No. 1 to Plate (Max.) .....		0.002 Pf
Input: g1 to (h + Pk, g3, IS + g2) .....		5.5 Pf
Output: p to (h + Pk, g3, IS + g2) .....		5.0 Pf

**Coupling**

Pentode Grid No. 1 to Diode Plate (Max.) .....	0.0015 Pf
Pentode Plate to Diode Plate (Max.) .....	0.095 Pf

**RATINGS (Design Maximum Rating System)**

Plate Voltage (Max.) .....	300 Volts
Grid No. 3 Voltage (Positive or Negative) (Max.) .....	300 Volts
Grid No. 2 Supply Voltage (Max.) .....	300 Volts
Grid No. 2 Voltage .....	See Rating Chart (Gen. Info. Sec.)
Positive Grid No. 1 Voltage (Max.) .....	0 Volt
Negative Grid No. 1 Voltage (Max.) .....	50 Volts
Plate Dissipation (Max.) .....	3.0 Watts
Grid No. 3 Input (Max.) .....	0.2 Watt
Grid No. 2 Input (Max.) .....	0.6 Watt
Diode Plate Current (Max.) .....	3.0 Ma

**CHARACTERISTICS AND TYPICAL OPERATION**

**Pentode—Class A1 Amplifier**

Plate Voltage .....	100 Volts
Grid No. 3 and Internal Shield .....	Tied to Cathode
Grid No. 2 Voltage .....	100 Volts
Grid No. 1 Voltage <sup>(1)</sup> .....	
Grid No. 1 Resistor .....	2.2 Megohms
Plate Current .....	9.0 Ma
Grid No. 2 Current .....	3.5 Ma
Transconductance .....	3800 $\mu$ mhos
Plate Resistance (Approx.) .....	250,000 Ohms
E <sub>c1</sub> for gm = 40 $\mu$ mhos (Approx.) .....	-20 Volts
Average Diode Current with 10 Volts DC Applied (Test Condition ONLY) .....	2.0 Ma

**NOTE:**

(1) Average contact potential bias developed across specified grid resistor.

Color Television Type  
**VHF AMPLIFIER**

**6ER5**  
2ER5, 3ER5

**Semi-Remote Cutoff Triode**

Construction ..... Miniature T-5½  
 Base ..... Button 7 Pin, E7-1  
 Basing ..... 7FP  
 Outline ..... 5-2  
 Maximum Diameter ..... 0.750 In.  
 Maximum Seated Height ..... 1.875 In.  
 Maximum Overall Height ..... 2.125 In.

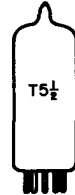
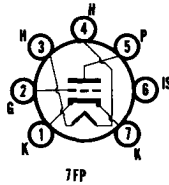

**ELECTRICAL DATA**

**HEATER OPERATION**

	2ER5	3ER5	6ER5
Heater Voltage.....	2.3	2.8	6.3 Volts
Heater Current .....	600	450	180 Ma
Maximum Heater-Cathode Voltage			
Heater Negative with Respect to Cathode			
Total DC and Peak.....			200 Volts
Heater Positive with Respect to Cathode			
DC .....			100 Volts
Total DC and Peak.....			200 Volts

**DIRECT INTERELECTRODE CAPACITANCES**

	Shielded	Unshielded
Grid to Plate .....	0.36	0.38 Pf
Input .....	4.4	4.4 Pf
Output .....	4.0	3.0 Pf
Heater to Cathode .....	2.8	2.8 Pf
Grid to Cathode.....	3.1	3.1 Pf
Plate to Cathode .....	0.2	0.24 Pf
Grid to Heater (Max.) .....	0.28	0.28 Pf

**RATINGS (Design Center Rating System)**

Supply Voltage (Max.) .....	550 Volts
Plate Voltage (Max.) .....	250 Volts
Plate Dissipation (Max.) .....	2.2 Watts
Cathode Current (Max.).....	20 Ma
Negative Grid Voltage (Max.) .....	50 Volts
Grid Circuit Resistance Cathode Bias (Max.) .....	1.0 Megohm

**CHARACTERISTICS AND TYPICAL OPERATION**

Plate Voltage .....	200 Volts
Grid Voltage .....	-1.2 Volts
Plate Current .....	10 Ma
Transconductance .....	10,500 $\mu$ mhos
Amplification Factor .....	80
Plate Resistance.....	8000 Ohms
E <sub>c1</sub> for G <sub>m</sub> = 500 $\mu$ mhos .....	-3.8 Volts
E <sub>c1</sub> for G <sub>m</sub> = 100 $\mu$ mhos .....	-5.6 Volts

# 6ES5

2ES5, 3ES5

# VHF AMPLIFIER

**High Mu Triode**

Construction ..... Miniature T-5½  
 Base ..... Button 7 Pin, E7-1  
 Basing ..... .7FP  
 Outline ..... 5-2  
 Maximum Diameter ..... 0.750 In.  
 Maximum Seated Height ..... 1.875 In.  
 Maximum Overall Height ..... 2.125 In.

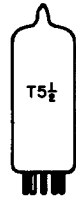
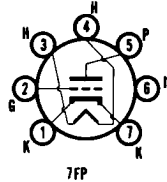

**ELECTRICAL DATA  
 HEATER OPERATION**

	2ES5	3ES5	6ES5
Heater Voltage.....	2.35	3.0	6.3 Volts
Heater Current .....	600	450	200 Ma
Heater Warm-up Time .....	11	11	— Seconds
Maximum Heater-Cathode Voltage			
Heater Negative with Respect to Cathode			
Total DC and Peak.....			200 Volts
Heater Positive with Respect to Cathode			
DC .....			100 Volts
Total DC and Peak.....			200 Volts

**DIRECT INTERELECTRODE CAPACITANCES**

	Shielded <sup>(1)</sup>	Unshielded
Grid to Plate: g to p (Max.) .....	0.5	0.5 Pf
Input: g to (h + k + IS) .....	3.2	3.2 Pf
Output: p to (h + k + IS) .....	4.0	3.2 Pf

**RATINGS (Design Maximum Rating System)**

Plate Voltage (Max.) .....	250 Volts
Positive Grid Voltage (Max.) .....	0 Volt
Plate Dissipation (Max.) .....	2.2 Watts
DC Cathode Current (Max.) .....	22 Ma
Grid Circuit Resistance (Max.).....	1.0 Megohm

**CHARACTERISTICS AND TYPICAL OPERATION**

**Class A1 Amplifier**

Plate Voltage .....	200 Volts
Grid Voltage .....	-1.0 Volt
Plate Resistance (Approx.) .....	8000 Ohms
Transconductance .....	9000 μmhos
Amplification Factor .....	75
Plate Current .....	10 Ma
Grid Voltage (Approx.) for 100 μa Plate Current .....	-6.0 Volts

**NOTE:**

(1) With external shield No. 316 connected to Pin 1.

# 6ES8/ECC189

4ES8, 5ES8

# VHF CASCODE AMPLIFIER

**Semi-Remote Cutoff Twin Triode**

Construction ..... Miniature T-6½  
 Base ..... Button 9 Pin, E9-1  
 Basing <sup>(1)</sup> ..... 9AJ  
 Outline ..... 6-2  
 Maximum Diameter ..... 0.875 In.  
 Maximum Seated Height ..... 1.937 In.  
 Maximum Overall Height ..... 2.187 In.

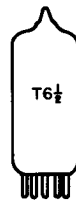
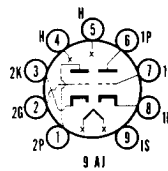

**ELECTRICAL DATA  
 HEATER OPERATION**

	4ES8	5ES8	6ES8/ECC189
Heater Voltage.....	4.0	5.6	6.3 Volts
Heater Current .....	600	450	365 Ma
Heater Warm-up Time .....	11	11	— Seconds

Maximum Heater Cathode Voltage	
RMS, Voltage Between Cathode and Heater (Grounded Cathode Section).....	50 Volts
RMS, Voltage Between Cathode and Heater (Grounded Grid Section).....	50 Volts
Cathode Positive with Respect to Heater (Grounded Grid Section).....	130 Volts

**DIRECT INTERELECTRODE CAPACITANCES (Each Section)**

	Unshielded	Shielded
Grid to Plate .....	1.85	1.85 Pf
Plate to Cathode .....	0.18	0.17 Pf
Heater to Cathode .....	3.0	3.0 Pf
Plate Section No. 1 to Plate Section No. 2 (Max.) ..	0.040	0.015 Pf
Plate Section No. 2 to Grid Section No. 1 (Max.) ..	0.003	0.003 Pf
Grid Section No. 1 to Cathode Section No. 2 (Max.)	0.002	0.002 Pf

**RATINGS (Design Center Rating System) (Each Section)**

Plate Supply Voltage (Ib = 0 Ma) (Max.).....	550 Volts
Plate Voltage (Max.) .....	130 Volts
Plate Dissipation (Max.) .....	1.8 Watts
Cathode Current (Max.).....	22 Ma
Negative Grid Voltage (Max.) .....	50 Volts
Grid Circuit Resistance (Max.).....	1.0 Megohm

**CHARACTERISTICS AND TYPICAL OPERATION**

**Class A1 Amplifier (Each Section)**

Plate Voltage .....	90 Volts
Grid Voltage .....	-1.2 Volts
Plate Current .....	15 Ma
Transconductance .....	12,500 $\mu$ mhos
Amplification Factor .....	34

**Cascode Amplifier<sup>(2)</sup>**

Supply Voltage.....	180 Volts
Plate Current .....	15 Ma
Transconductance .....	12,500 $\mu$ mhos
Noise Figure <sup>(3)</sup> .....	6.5 db
Ec for gm = 125 $\mu$ a (Approx.).....	-9.0 Volts
Input Voltage for Cross Modulation Factor of 1% at gm = 125 $\mu$ mhos ...	500 Mv

**NOTES:**

- (1) Section No. 1 (grounded cathode input section) connects to Pins 6, 7, and 8.  
Section No. 2 (grounded grid output section) connects to Pins 1, 2, and 3.
- (2) The grid of the output section, Section No. 2, is connected to a potentiometer.
- (3) Noise figure measurements taken with tube operating in a TV tuner.

**HORIZONTAL PHASE DETECTOR (D)  
VIDEO AMPLIFIER (P)**

**6E77**

8E77

**Double Diode and  
Sharp Cutoff Pentode**

Construction .....	Miniature T-6 $\frac{1}{2}$
Base .....	Button 9 Pin, E9-1
Basing .....	.9LT
Outline .....	6-3
Maximum Diameter .....	0.875 In.
Maximum Seated Height .....	2.375 In.
Maximum Overall Height .....	2.625 In.

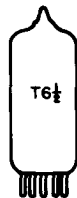
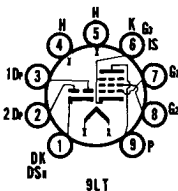

**ELECTRICAL DATA  
HEATER OPERATION**

	8E77	6E77
Heater Voltage.....	8.0	6.3 Volts
Heater Current .....	600	750 Ma
Heater Warm-up Time .....	11	— Seconds
Maximum Heater-Cathode Voltage		
Heater Negative with Respect to Cathode		
Total DC and Peak.....		200 Volts
Heater Positive with Respect to Cathode		
DC .....		100 Volts
Total DC and Peak.....		200 Volts

**DIRECT INTERELECTRODE CAPACITANCES (Unshielded)**

**Pentode Section**

Grid No. 1 to Plate (Max.).....	0.1 Pf
Input: g1 to (h + Pk, g3, IS + g2 + Dk, Dsh) .....	10 Pf

Output: p to (h + Pk, g <sub>2</sub> , IS + g <sub>2</sub> + Dk, Dsh) .....	4.2 Pf
<b>Diode Section (Each Diode)</b>	
Diode Plate to (h + Dk, Dsh + Pk, g <sub>3</sub> , IS) .....	1.5 Pf
Diode Cathode; Diode Shield to (h + Dp + Pk, g <sub>3</sub> , IS) .....	7.5 Pf
<b>Coupling</b>	
Pentode Grid No. 1 to Diode Plate (Each Diode) (Max.) .....	0.005 Pf
Pentode Plate to Diode Plate (Each Diode) (Max.) .....	0.02 Pf
<b>RATINGS (Design Maximum Rating System)</b>	
Plate Voltage (Max.) .....	330 Volts
Grid No. 2 Supply Voltage (Max.) .....	330 Volts
Grid No. 2 Voltage .....	See Rating Chart (Gen. Info. Sec.)
Positive Grid No. 1 Voltage (Max.) .....	0 Volt
Plate Dissipation (Max.) .....	5.0 Watts
Grid No. 2 Dissipation (Max.) .....	1.1 Watts
Grid No. 1 Circuit Resistance	
Cathode Bias (Max.) .....	0.25 Megohms
Fixed Bias (Max.) .....	0.1 Megohm

**CHARACTERISTICS AND TYPICAL OPERATION**

**Pentode—Class A1 Amplifier**

Plate Voltage .....	200 Volts
Grid No. 2 Voltage .....	150 Volts
Cathode Bias Resistor .....	100 Ohms
Plate Current .....	25 Ma
Grid No. 2 Current .....	5.5 Ma
Transconductance .....	11,500 $\mu$ mhos
Plate Resistance (Approx.) .....	60,000 Ohms
Ec1 for Ib = 100 $\mu$ a (Approx.) .....	-10 Volts
Average Diode Current with 10 Volts DC Applied (Each Diode) .....	1.5 Ma

**INSTANTANEOUS PLATE KNEE VALUES**

Eb = 60 V, Ec2 = 150 V, Ec1 = 0 V;  
Ib = 55 Ma and Ic2 = 18 Ma



**High Mu Twin Triode**

Construction .....	Miniature T-6½
Base .....	Button 9 Pin, E9-1
Basing .....	9LS
Outline .....	6-2
Maximum Diameter .....	0.875 In.
Maximum Seated Height .....	1.937 In.
Maximum Overall Height .....	2.187 In.

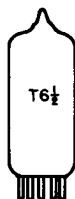
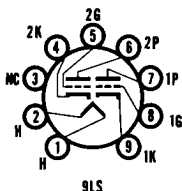

**ELECTRICAL DATA**

**HEATER OPERATION**

Heater Voltage .....	6.3 Volts
Heater Current .....	300 Ma
Maximum Heater-Cathode Voltage	
Heater Negative with Respect to Cathode	
Total DC and Peak .....	200 Volts
Heater Positive with Respect to Cathode	
DC .....	100 Volts
Total DC and Peak .....	200 Volts

**DIRECT INTERELECTRODE CAPACITANCES (Unshielded)**

	<b>Section 1</b>	<b>Section 2</b>
Grid to Plate .....	1.5	1.5 Pf
Input: g to (h + k) .....	1.6	1.6 Pf
Output: p to (h + k) .....	0.2	0.2 Pf

**RATINGS (Design Maximum Rating System) (Each Section)**

Plate Voltage (Max.) .....	330 Volts
Plate Dissipation (Max.) .....	1.2 Watts
Positive Grid Voltage (Max.) .....	0 Volt
Negative Grid Voltage (Max.) .....	55 Volts

**CHARACTERISTICS AND TYPICAL OPERATION**

**Class A1 Amplifier (Each Section)**

Plate Voltage .....	100	250 Volts
Grid Voltage .....	-1	-2 Volts
Plate Current .....	0.5	1.2 Ma
Transconductance .....	1250	1600 $\mu$ mhos
Amplification Factor .....	100	100

Plate Resistance.....	80,000	62,500 Ohms
Equivalent Noise and Hum Voltage (Referenced to Grid—Each Unit) Average Value <sup>(1)</sup> (RMS) ...	—	1.8 $\mu$ Volts

**NOTE:**

(1) Measured under the following conditions: Ef = 6.3 Vac, center-tap of heater transformer grounded; Ebb = 250 Vdc; Rb = 0.1 Megohm; Rk = 2700 Ohms; Ck = 100  $\mu$ f; Rg = 0; F = 25 to 10,000 Hz.

**OSCILLATOR (T)  
MIXER (P)**

**6E8**  
5E8

**Medium Mu Triode and Sharp Cutoff Pentode**

Construction ..... Miniature T-6½  
 Base ..... Button 9 Pin, E9-1  
 Basing..... 9JF  
 Outline ..... 6-2  
     Maximum Diameter ..... 0.875 In.  
     Maximum Seated Height ..... 1.937 In.  
     Maximum Overall Height ..... 2.187 In.

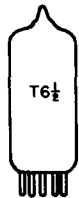
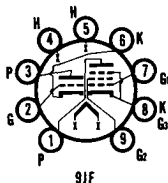

**ELECTRICAL DATA  
HEATER OPERATION**

	<b>5E8</b>	<b>6E8</b>
Heater Voltage.....	4.7	6.3 Volts
Heater Current .....	600	450 Ma
Heater Warm-up Time .....	11	11 Seconds
Maximum Heater-Cathode Voltage Heater Negative with Respect to Cathode Total DC and Peak.....		200 Volts
Heater Positive with Respect to Cathode DC .....		100 Volts
Total DC and Peak.....		200 Volts

**DIRECT INTERELECTRODE CAPACITANCES**

**Pentode Section**

Grid No. 1 to Plate: (g1 to p) (Max.) .....	0.10	0.02 Pf
Input: g1 to (h + k) .....	5.0	5.0 Pf
Output: p to (h + k) .....	3.4	2.6 Pf

**Triode Section**

Grid to Plate: (g to p) .....	1.7	1.7 Pf
Input: g to (h + k) .....	3.2	3.0 Pf
Output: p to (h + k + s) .....	1.1	1.6 Pf
Cathode to Heater (Each Section): (k to h) .....	3.60	3.60 Pf

**RATINGS (Design Center Rating System)**

	<b>Triode</b>	<b>Pentode</b>
Plate Voltage (Max.) .....	330	330 Volts
Grid No. 2 Supply Voltage (Max.) .....	—	330 Volts
Positive DC Grid No. 1 Voltage (Max.) .....	0	0 Volt
Plate Dissipation (Max.) .....	3.0	3.1 Watts
Grid No. 2 Dissipation (Max.) .....	—	0.55 Watts
Grid No. 1 Resistance (Max.) .....	100	100 Kilohms

**CHARACTERISTICS AND TYPICAL OPERATION**

	<b>Triode</b>	<b>Pentode</b>
Plate Voltage .....	150	125 Volts
Grid No. 2 Voltage .....	—	125 Volts
Cathode Resistor .....	56	— Ohms
Grid No. 1 Voltage .....	—	-1.0 Volt
Amplification Factor .....	40.0	—
Transconductance .....	8500	6400 $\mu$ mhos
Plate Resistance (Approx.) .....	5000	80,000 Ohms
Plate Current .....	18.0	12.0 Ma
Grid No. 2 Current .....	—	4.0 Ma
Grid No. 1 Voltage (Approx.) for Ib = 10 $\mu$ a .....	-12.0	-9.0 Volts
Cathode Warm-up Time <sup>(1)</sup> .....	35	— Seconds

**NOTE:**

(1) Cathode Warm-up Time is defined as the time required for transconductance to reach 6500  $\mu$ mhos when a tube is operated from a cold start at a plate potential of 100 volts dc, zero grid bias, and at a constant heater current of 560 milliamperes for 5E8 or a heater potential of 5.5 volts for the 6E8.

# 6EV5

2EV5, 3EV5

## VHF AMPLIFIER

**Sharp Cutoff Tetrode**

Construction ..... Miniature T-5½  
 Base ..... Button 7 Pin, E7-1  
 Basing ..... 7EW  
 Outline ..... 5-2  
 Maximum Diameter ..... 0.750 In.  
 Maximum Seated Height ..... 1.875 In.  
 Maximum Overall Height ..... 2.125 In.

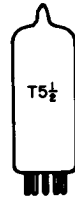
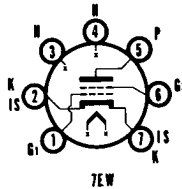

**ELECTRICAL DATA**

**HEATER OPERATION**

	2EV5	3EV5	6EV5
Heater Voltage.....	2.4	2.9	6.3 Volts
Heater Current.....	600	450	200 Ma
Heater Warm-up Time.....	11	11	— Seconds
Maximum Heater-Cathode Voltage			
Heater Negative with Respect to Cathode			
Total DC and Peak.....			100 Volts
Heater Positive with Respect to Cathode			
DC.....			50 Volts
Total DC and Peak.....			100 Volts

**DIRECT INTERELECTRODE CAPACITANCES (Shielded)<sup>(1)</sup>**

Grid No. 1 to Plate (Max.).....	0.035 Pf
Input.....	4.5 Pf
Output.....	2.9 Pf

**RATINGS (Design Maximum Rating System)**

Plate Voltage (Max.).....	275 Volts
Grid No. 2 Supply Voltage (Max.).....	180 Volts
Grid No. 2 Voltage.....	See Rating Chart (Gen. Info. Sec.)
Plate Dissipation (Max.).....	3.25 Watts
Grid No. 2 Dissipation (Max.).....	0.2 Watt
Positive Grid No. 1 Voltage (Max.).....	0 Volt
Cathode Current (Max.).....	20 Ma
Grid Circuit Resistance (Max.).....	0.5 Megohm

**CHARACTERISTICS AND TYPICAL OPERATION**

Plate Voltage.....	250 Volts
Grid No. 2 Voltage.....	80 Volts
Grid No. 1 Voltage.....	-1 Volt
Plate Current.....	11.5 Ma
Grid No. 2 Current.....	0.9 Ma
Transconductance.....	8800 μmhos
Plate Resistance.....	0.150 Megohm
E <sub>c1</sub> for G <sub>m</sub> = 100 μmhos (Approx.).....	-4.5 Volts

**NOTE:**

(1) Shield No. 316 connected to cathode.

# 6EW6

4EW6, 5EW6, 15EW6

## Color Television Type IF AMPLIFIER

**Sharp Cutoff Pentode**

Construction ..... Miniature T-5½  
 Base ..... Button 7 Pin, E7-1  
 Basing ..... 7CM  
 Outline ..... 5-2  
 Maximum Diameter ..... 0.750 In.  
 Maximum Seated Height ..... 1.875 In.  
 Maximum Overall Height ..... 2.125 In.

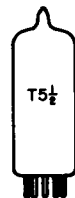
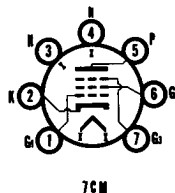



**ELECTRICAL DATA  
HEATER OPERATION**

	15EW6	5EW6	4EW6	6EW6
Heater Voltage.....	15.0	5.6	4.2	6.3 Volts
Heater Current .....	150	450	600	400 Ma
Heater Warm-up Time .....	—	11	11	— Seconds
Maximum Heater-Cathode Voltage				
Heater Negative with Respect to Cathode				
Total DC and Peak.....	200 Volts			
Heater Positive with Respect to Cathode				
DC .....	100 Volts			
Total DC and Peak.....	200 Volts			

**DIRECT INTERELECTRODE CAPACITANCES**

	Shielded <sup>(1)</sup>	Unshielded
Grid No. 1 to Plate (Max.).....	0.03	0.04 Pf
Input: g1 to (h + k + g2 + g3 + IS).....	10.0	10.0 Pf
Output: p to (h + k + g2 + g3 + IS).....	3.4	2.4 Pf

**RATINGS (Design Maximum Rating System)**

Plate Voltage (Max.) .....	330 Volts
Grid No. 2 Supply Voltage (Max.) .....	330 Volts
Grid No. 2 Voltage .....	See Rating Chart (Gen. Info. Sec.)
Positive Grid No. 1 Voltage (Max.) .....	0 Volt
Plate Dissipation (Max.) .....	3.1 Watts
Grid No. 2 Dissipation (Max.) .....	0.65 Watts

**CHARACTERISTICS AND TYPICAL OPERATION**

**Class A1 Amplifier**

Plate Voltage .....	125 Volts
Grid No. 3 .....	Tied to Cathode
Grid No. 2 Voltage .....	125 Volts
Cathode Bias Resistor .....	56 Ohms
Plate Current .....	11 Ma
Grid No. 2 Current .....	3.2 Ma
Transconductance .....	14,000 $\mu$ mhos
Plate Resistance (Approx.) .....	0.2 Megohm
Grid No. 1 Voltage for Ib = 20 $\mu$ a (Approx.) .....	-3.5 Volts

**NOTE:**

(1) Shield No. 316 tied to cathode.

**VERTICAL DEFLECTION  
OSCILLATOR and AMPLIFIER**

**6EW7**

10EW7, 15EW7,  
19EW7, 20EW7

**Dissimilar Double Triode**

Construction .....	9T-9
Base .....	Button 9 Pin, E9-68
Basing <sup>(1)</sup> .....	9HF
Outline .....	9-70
Maximum Diameter .....	1.188 In.
Maximum Seated Height .....	2.620 In.
Maximum Overall Height .....	2.930 In.

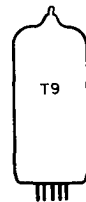
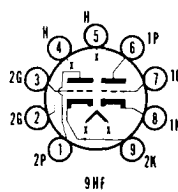

**ELECTRICAL DATA**

**HEATER OPERATION**

	20EW7	19EW7	15EW7	10EW7	6EW7
Heater Voltage.....	20.5	18.9	14.8	9.7	6.3 Volts
Heater Current .....	300	300	450	600	900 Ma
Heater Warm-up Time .....	11	11	11	11	— Seconds
Maximum Heater-Cathode Voltage					
Heater Negative with Respect to Cathode					
Total DC and Peak.....	200 Volts				
Heater Positive with Respect to Cathode					
DC .....	100 Volts				
Total DC and Peak.....	200 Volts				

**DIRECT INTERELECTRODE CAPACITANCES (Unshielded)**

	Section <sup>(1)</sup> No. 1	Section <sup>(1)</sup> No. 2
Grid to Plate .....	4.2	9.0 Pf
Input: g to (h + k) .....	2.2	7.0 Pf
Output: p to (h + k) .....	0.4	1.2 Pf

**RATINGS (Design Maximum Rating System)  
Vertical Deflection Oscillator and Amplifier<sup>(2)</sup>**

	Section <sup>(1)</sup> No. 1 Oscillator	Section <sup>(1)</sup> No. 2 Amplifier
Plate Voltage (Max.) .....	330	330 Volts
Peak Positive Pulse Plate Voltage (Max.) .....	—	1500 Volts
Peak Negative Pulse Grid Voltage (Max.) .....	400	250 Volts
Plate Dissipation (Max.) <sup>(3)</sup> .....	1.5	10 Watts
Average Cathode Current (Max.) .....	22	50 Ma
Peak Cathode Current (Max.) .....	77	175 Ma
Grid Circuit Resistance		
Self Bias (Max.) .....	2.2	2.2 Megohms

**CHARACTERISTICS AND TYPICAL OPERATION**

	Section <sup>(1)</sup> No. 1	Section <sup>(1)</sup> No. 2
Plate Voltage .....	250	150 Volts
Grid No. 1 Voltage .....	-11	-17.5
Plate Current .....	5.5	45 Ma
Transconductance .....	2000	7500 $\mu$ mhos
Amplification Factor .....	17.5	6.0
Plate Resistance (Approx.) .....	8750	800 Ohms
Ec for Ib = 10 $\mu$ a (Approx.) .....	-20	— Volts
Ec for Ib = 100 $\mu$ a (Approx.) .....	—	-40 Volts
Ib at Ec = -25 Vdc .....	—	8 Ma
Ib with Eb = 60 V and Ec = 0 V (Instantaneous Values) .....	—	95 Ma

**NOTES:**

- (1) Section No. 1 connects to Pins 6, 7 and 8. Section No. 2 connects to Pins 1, 2, 3 and 9.
- (2) For operation in a 525 line, 30 frame system as described in "Standards of Good Engineering Practice for Television Broadcast Stations; Federal Communications Commission," the duty cycle of the voltage pulse must not exceed 15% of one horizontal scanning cycle.
- (3) In stages operating with grid leak bias, an adequate bias resistor or other suitable means is required to protect the tube in the absence of excitation.

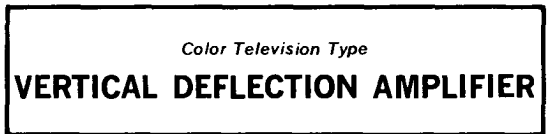

**Beam Power Pentode**

Construction .....	Octal T-9
Base .....	Octal 6 Pin, B6-81
Basing .....	7AC
Outline .....	9-15
Maximum Diameter .....	1.188 In.
Maximum Seated Height .....	2.875 In.
Maximum Overall Height .....	3.438 In.

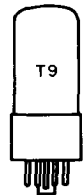
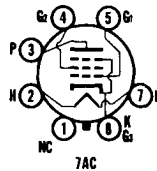

**ELECTRICAL DATA**

**HEATER OPERATION**

Heater Voltage .....	6.3 Volts
Heater Current .....	800 Ma
Maximum Heater-Cathode Voltage	
Heater Negative with Respect to Cathode	
Total DC and Peak .....	200 Volts
Heater Positive with Respect to Cathode	
DC .....	100 Volts
Total DC and Peak .....	200 Volts

**DIRECT INTERELECTRODE CAPACITANCES (Unshielded)**

Grid No. 1 to Plate .....	0.6 Pf
Input .....	9.0 Pf
Output .....	7.0 Pf

**RATINGS (Design Maximum Rating System)**

**Vertical-Deflection-Amplifier Service<sup>(1)</sup>**

DC Plate Voltage (Max.) .....	350 Volts
Peak Pulse Plate Voltage (Max.) .....	2500 Volts
Screen Voltage (Max.) .....	300 Volts
Plate Dissipation (Max.) <sup>(2)</sup> .....	12 Watts
Screen Dissipation (Max.) <sup>(2)</sup> .....	2.75 Watts
DC Cathode Current (Max.) .....	75 Ma
Peak Cathode Current (Max.) .....	260 Ma

Grid No. 1 Circuit Resistance		
With Cathode Bias (Max.)	.....	2.2 Megohms
With Fixed Bias (Max.)	.....	1.0 Megohm
Bulb Temperature at Hottest Point (Max.)	.....	200 °C

**CHARACTERISTICS AND TYPICAL OPERATION**

Plate Voltage	.....	60	250 Volts
Screen Voltage	.....	250	250 Volts
Grid No. 1 Voltage	.....	0 <sup>(3)</sup>	-20 Volts
Plate Resistance (Approx.)	.....	—	50,000 Ohms
Transconductance	.....	—	4100 $\mu$ mhos
Plate Current	.....	180	43 Ma
Screen Current	.....	26	3.5 Ma
Grid No. 1 Voltage (Approx.)	.....	—	-50 Volts
$I_b = 100 \mu$ a	.....	—	

**NOTES:**

- (1) For operation in a 525 line, 30 frame system as described in "Standards of Good Engineering Practice for Television Broadcast Stations; Federal Communications Commission," the duty cycle of the voltage pulse must not exceed 15% of one horizontal scanning cycle.
- (2) In stages operating with grid leak bias, an adequate cathode-bias resistor or other suitable means is required to protect the tube in the absence of excitation.
- (3) Applied for short interval (two seconds maximum) so as not to damage tube.

Color Television Type

**VHF AMPLIFIER or  
OSCILLATOR and MIXER**

**6EZ8**

19EZ8

**Triple Triode**

Construction	.....	Miniature T-6½
Base	.....	Buttton 9 Pin, E9-1
Basing <sup>(1)</sup>	.....	.9KA
Outline	.....	6-2
Maximum Diameter	.....	0.875 In.
Maximum Seated Height	.....	1.937 In.
Maximum Overall Height	.....	2.187 In.

**ELECTRICAL DATA  
HEATER OPERATION**

	19EZ8	6EZ8	
Heater Voltage	.....	18.9	6.3 Volts
Heater Current	.....	150	450 Ma
Maximum Heater-Cathode Voltage	.....		
Heater Negative with Respect to Cathode	.....		
Total DC and Peak	.....		200 Volts
Heater Positive with Respect to Cathode	.....		
DC	.....		100 Volts
Total DC and Peak	.....		200 Volts

**DIRECT INTERELECTRODE CAPACITANCES**

	Shielded	Unshielded	
Grid to Plate (Each Section)	.....	1.5	1.5 Pf
Input (Each Section)	.....	2.6	2.4 Pf
Output (Section No. 1)	.....	1.4	0.21 Pf
Output (Section No. 2)	.....	1.2	0.4 Pf
Output (Section No. 3)	.....	1.2	0.36 Pf
Heater to Cathode (Section No. 3)	.....	0.15	0.17 Pf

**RATINGS (Design Maximum Rating System) (Each Section)**

Plate Voltage (Max.)	.....	300 Volts
Plate Dissipation (Each Plate) (Max.)	.....	2.0 Watts
Plate Dissipation (Plates 1, 2 and 3) (Max.)	.....	5.0 Watts
Positive Grid Voltage (Max.)	.....	0 Volt
Negative Grid Voltage (Max.)	.....	50 Volts

**CHARACTERISTICS AND TYPICAL OPERATION**

**Class A1 Amplifier—Each Section**

Plate Voltage	.....	125 Volts
Grid Voltage	.....	-1.0 Volt
Plate Current	.....	4.2 Ma
Plate Resistance	.....	13,600 Ohms
Transconductance	.....	4200 $\mu$ mhos
Amplification Factor	.....	57
$E_c$ for $I_b = 20 \mu$ a	.....	-4 Volts

**NOTE:**

- (1) Section No. 1 connects to Pins 4, 8 and 9. Section No. 2 connects to Pins 4, 6 and 7. Section No. 3 connects to Pins No. 1, 2 and 3.

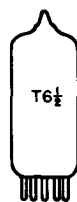
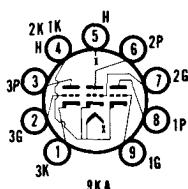

**6FD7**

10FD7, 13FD7

**VERTICAL DEFLECTION  
OSCILLATOR and AMPLIFIER****Dissimilar Double Triode**

Construction .....	9T-9
Base .....	Button 9 Pin, E9-68
Basing <sup>(1)</sup> .....	9HF
Outline .....	9-70 or 9-77
Maximum Diameter .....	1.188 In.
Maximum Seated Height .....	2.620 In.
Maximum Overall Height .....	2.900 In.

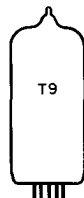
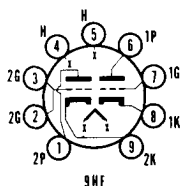
**ELECTRICAL DATA****HEATER OPERATION**

	13FD7	10FD7	6FD7
Heater Voltage.....	13.0	9.7	6.3 Volts
Heater Current .....	450	600	925 Ma
Heater Warm-up Time .....	11	11	— Seconds
Maximum Heater-Cathode Voltage			
Heater Negative with Respect to Cathode			
Total DC and Peak.....			200 Volts
Heater Positive with Respect to Cathode			
DC .....			100 Volts
Total DC and Peak.....			200 Volts

**DIRECT INTERELECTRODE CAPACITANCES (Unshielded)**

	Section <sup>(1)</sup>	Section <sup>(1)</sup>
	No. 1	No. 2
Grid to Plate .....	4.5	10 Pf
Input: g to (h + k) .....	2.2	6.5 Pf
Output: p to (h + k) .....	0.40	1.2 Pf

**RATINGS (Design Maximum Rating System)****Vertical Deflection Oscillator and Amplifier<sup>(2)</sup>**

	Section <sup>(1)</sup>	Section <sup>(1)</sup>
	No. 1 Oscillator	No. 2 Amplifier
Plate Voltage (Max.) .....	330	330 Volts
Peak Positive Pulse Plate Voltage (Max.) .....	—	1500 Volts
Peak Negative Pulse Grid Voltage (Max.) .....	400	250 Volts
Plate Dissipation (Max.) <sup>(3)</sup> .....	1.5	10 Watts
Average Cathode Current.....	20	50 Ma
Peak Cathode Current (Max.) .....	70	175 Ma
Grid Circuit Resistance		
Self Bias .....	2.2	2.2 Megohms

**CHARACTERISTICS AND TYPICAL OPERATION**

	Section <sup>(1)</sup>	Section <sup>(1)</sup>
	No. 1	No. 2
Plate Voltage .....	250	150 Volts
Grid No. 1 Voltage .....	-3	-17.5 Volts
Plate Current .....	1.4	40 Ma
Transconductance .....	1600	7500 $\mu$ mhos
Amplification Factor .....	64	6.0
Plate Resistance (Approx.) .....	40,000	800 Ohms
Ec for Ib = 10 $\mu$ a (Approx.).....	-5.5	— Volts
Ec for Ib = 100 $\mu$ a (Approx.).....	—	-40 Volts
Gm at Ib = 1.0 Ma .....	—	500 $\mu$ mhos
Ib at Ec = -25 Vdc (Approx.) .....	—	6 Ma
Ib with Eb = 60 V and Ec = 0 V (Instantaneous Values)....	—	95 Ma

**NOTES:**

- (1) Section No. 1 connects to Pins 6, 7 and 8. Section No. 2 connects to Pins 1, 2 and 9.
- (2) For operation in a 525 line, 30 frame system as described in "Standards of Good Engineering Practice for Television Broadcast Stations; Federal Communications Commission," the duty cycle of the voltage pulse must not exceed 15% of one horizontal scanning cycle.
- (3) In stages operating with grid leak bias, an adequate bias resistor or other suitable means is required to protect the tube in the absence of excitation.

Color Television Type  
**VHF OSCILLATOR and MIXER**

**6FG7**  
5FG7

**Medium Mu Triode and Semi-Remote Cutoff Pentode**

Construction ..... Miniature T-6½  
 Base ..... Button 9 Pin, E9-1  
 Basing ..... 9GF  
 Outline ..... 6-2  
 Maximum Diameter ..... 0.875 In.  
 Maximum Seated Height ..... 1.937 In.  
 Maximum Overall Height ..... 2.187 In.

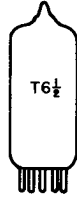
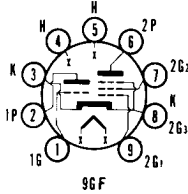

**ELECTRICAL DATA**  
**HEATER OPERATION**

	5FG7	6FG7
Heater Voltage.....	4.7	6.3 Volts
Heater Current.....	600	450 Ma
Heater Warm-up Time.....	11	11 Seconds
Maximum Heater-Cathode Voltage		
Heater Negative with Respect to Cathode		
Total DC and Peak.....		200 Volts
Heater Positive with Respect to Cathode		
DC.....		100 Volts
Total DC and Peak.....		200 Volts

**DIRECT INTERELECTRODE CAPACITANCES**

	Shielded (1)	Unshielded
<b>Triode Section</b>		
Grid to Plate.....	1.8	1.8 Pf
Input: g to (h + k).....	3.0	3.0 Pf
Output: p to (h + k).....	1.9	1.3 Pf
<b>Pentode Section</b>		
Grid No. 1 to Plate (Max.).....	0.01	0.020 Pf
Input: g1 to (h + k + g2).....	5.0	5.0 Pf
Output: p to (h + k + g2).....	3.4	2.4 Pf

**AVERAGE PLATE CHARACTERISTICS**  
**(Pentode Section)**

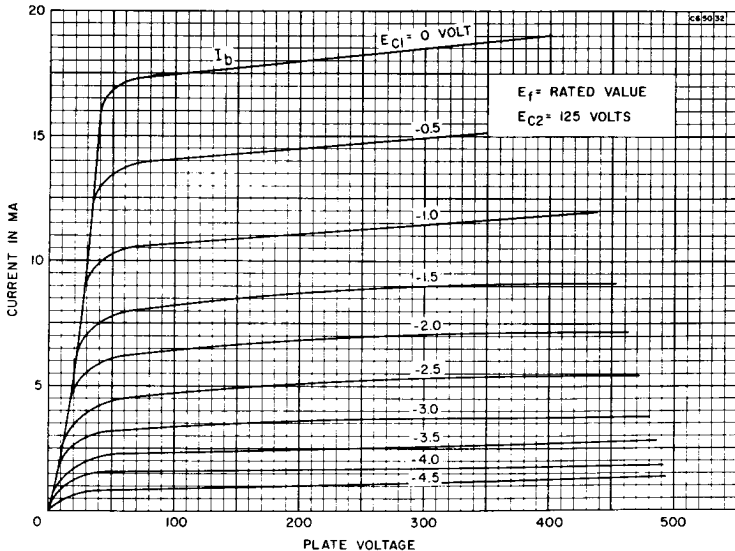

**AVERAGE PLATE CHARACTERISTICS  
(Triode Section)**

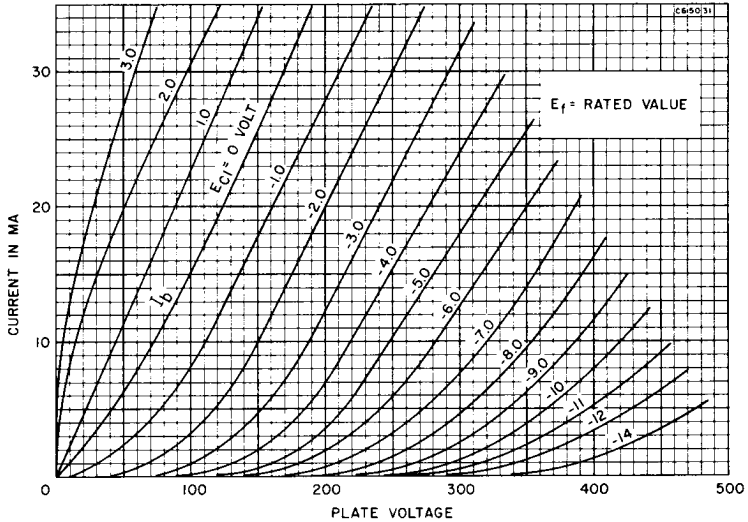

**RATINGS (Design Maximum Rating System)**

	Triode Section	Pentode Section
Plate Voltage (Max.)	330	330 Volts
Grid No. 2 Supply Voltage (Max.)	—	330 Volts
Grid No. 2 Voltage	See Rating Chart (Gen. Info. Sec.)	
Plate Dissipation (Max.)	2.5	3.0 Watts
Grid No. 2 Dissipation (Max.)	—	0.55 Watt
Positive Grid No. 1 Voltage (Max.)	0	0 Volt

**CHARACTERISTICS AND TYPICAL OPERATION**

**Class A1 Amplifier**

	Triode Section	Pentode Section
Plate Voltage	125	125 100 Volts
Grid No. 2 Voltage	—	125 100 Volts
Grid No. 1 Voltage	-1.0	-1.0 0 Volt
Plate Current	13	11 — Ma
Grid No. 2 Current	—	4.0 — Ma
Transconductance	7500	6000 7400 $\mu$ mhos
Amplification Factor	43	—
Plate Resistance	5700	180K — Ohms
Grid No. 1 Voltage for $I_b = 30 \mu$ a (Approx.)	-6.5	-7.5 — Volts

**NOTE:**

(1) Shield No. 315 connected to cathode of section under test.

**6FH5**  
2FH5, 3FH5

Color Television Type  
**VHF AMPLIFIER**

**High Mu Triode**

Construction ..... Miniature T-5½  
 Base ..... Button 7 Pin, E7-1  
 Basing ..... 7FP  
 Outline ..... 5-2  
 Maximum Diameter ..... 0.750 in.  
 Maximum Seated Height ..... 1.875 in.  
 Maximum Overall Height ..... 2.125 in.

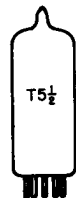
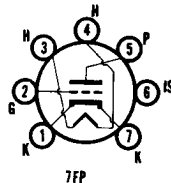

**ELECTRICAL DATA  
HEATER OPERATION**

	<b>2FH5</b>	<b>3FH5</b>	<b>6FH5</b>
Heater Voltage.....	2.35	3.0	6.3 Volts
Heater Current .....	600	450	200 Ma
Heater Warm-up Time .....	11	11	— Seconds
Heater-Cathode Voltage			
Heater Negative with Respect to Cathode			
Total DC and Peak.....			100 Volts
Heater Positive with Respect to Cathode			
Total DC and Peak.....			100 Volts

**DIRECT INTERELECTRODE CAPACITANCES**

	<b>Shielded</b>	<b>Unshielded</b>
Grid to Plate (Max.).....	0.6	0.6 Pf
Input: g to (h + k + IS) .....	3.2	3.2 Pf
Output: p to (h + k + IS) .....	4.0	3.2 Pf

**RATINGS (Design Maximum Rating System)**

Plate Voltage (Max.) .....	150 Volts
Plate Dissipation (Max.) .....	2.2 Watts
Cathode Current (Max.).....	22 Ma
Positive Grid Voltage (Max.) .....	0 Volt
Grid Circuit Resistance (Max.).....	1.0 Megohm

**CHARACTERISTICS AND TYPICAL OPERATION**

**Class A1 Amplifier**

Plate Voltage .....	135 Volts
Grid Voltage .....	-1.0 Volt
Plate Current .....	11 Ma
Transconductance .....	9000 $\mu$ mhos
Amplification Factor .....	50
Plate Resistance (Approx.) .....	5600 Ohms
Ec for Ib = 100 $\mu$ a (Approx.).....	-5.5 Volts



**Medium Mu Triode  
Sharp Cutoff Tetrode (3 Plates)**

- Construction ..... Miniature T-6½
- Base ..... Button 9 Pin, E9-1
- Basing ..... 9KP
- Outline ..... 6-2
- Maximum Diameter ..... 0.875 In.
- Maximum Seated Height ..... 1.937 In.
- Maximum Overall Height ..... 2.187 In.

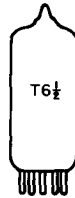
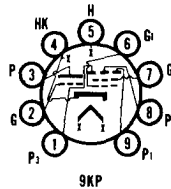

**ELECTRICAL DATA**

**HEATER OPERATION**

Heater Voltage.....	6.3 Volts
Heater Current .....	450 Ma

**DIRECT INTERELECTRODE CAPACITANCES (Shielded)<sup>(1)</sup>**

**Triode Unit**

Grid to Plate .....	1.4 Pf
Grid to Cathode and Heater .....	2.6 Pf
Plate to Cathode and Heater.....	1 Pf

**Tetrode Unit**

Grid No. 1 to Plate No. 1 (Max.) .....	0.060 Pf
Grid No. 1 to Cathode, Heater, Grid No. 2, Plate No. 2, and Plate No. 3 .....	4.5 Pf
Plate No. 1 to Cathode, Heater, Grid No. 2, Plate No. 2, and Plate No. 3 .....	1.4 Pf
Tetrode Grid No. 1 to Triode Plate (Max.).....	0.35 Pf
Tetrode Plate No. 1 to Triode Plate (Max.).....	0.008 Pf

**RATINGS (Design Maximum Rating System)**

**Harmonic Generator Service**

	<b>Triode Unit</b>	<b>Tetrode Unit</b>
Plate Voltage (Max.) .....	275	— Volts
Plate No. 1 Voltage (Max.) .....	—	275 Volts
Plate No. 2 Voltage (Max.) .....	—	200 Volts
Plate No. 3 Voltage (Max.) .....	—	200 Volts

Grid No. 2 Supply Voltage (Max.) .....	—	275 Volts
Grid No. 2 (Screen-Grid) Voltage .....	See Rating Chart (Gen. Info. Sec.)	
Grid No. 1 (Control-Grid) Voltage		
Negative Bias Value (Max.) .....	40	40 Volts
Positive Bias Value (Max.) .....	0	0 Volt
Plate Dissipation (Max.) .....	1.7	— Watts
Plate No. 1 Dissipation (Max.) .....	—	2.3 Watts
Plate No. 2 Dissipation (Max.) .....	—	0.3 Watt
Plate No. 3 Dissipation (Max.) .....	—	0.3 Watt
Grid No. 2 Input		
For Grid No. 2 Voltages Up to 137.5 Volts (Max.) .....	—	0.45 Watt
For Grid No. 2 Voltages Between 137.5 and 275 Volts .....	See Rating Chart (Gen. Info. Sec.)	
Grid No. 1 Circuit Resistance		
For Fixed Bias Operation (Max.) .....	0.5	0.5 Megohm

**CHARACTERISTICS AND TYPICAL OPERATION**

**Class A1 Amplifier**

**Triode Unit**

Plate Voltage .....	100 Volts
Grid Voltage .....	-1 Volt
Amplification Factor .....	40
Plate Resistance (Approx.) .....	7400 Ohms
Transconductance .....	5400 $\mu$ mhos
Plate Current .....	7.9 Ma
Grid Voltage (Approx.) for Plate Current of 100 $\mu$ a .....	-7 Volts

**Tetrode Unit with Plates No. 2 and No. 3 Connected to Cathode**

Plate No. 1 Voltage .....	250 Volts
Grid No. 2 Voltage .....	250 Volts
Grid No. 1 Voltage .....	-2 Volts
Plate No. 1 Resistance (Approx.) .....	750,000 Ohms
Transconductance, Grid No. 1 to Plate No. 1 .....	4400 $\mu$ mhos
Plate No. 1 Current .....	7.3 Ma
Grid No. 2 Current .....	1.4 Ma
Grid No. 1 Voltage (Approx.) for Plate No. 1 Current of 100 $\mu$ a .....	-7 Volts

**Typical Operation with Separate Plate Operation**

Plates No. 1, No. 2, and No. 3 Voltage .....	100 Volts
Grid No. 2 Voltage .....	50 Volts
Grid No. 1 Voltage .....	-1 Volt
Plate No. 1 Current .....	1.6 Ma
Plate No. 2 Current .....	0.04 Ma
Plate No. 3 Current .....	0.04 Ma
Grid No. 2 Current .....	0.3 Ma
Transconductance (Approx.)	
Grid No. 1 to Plate No. 1 .....	2500 $\mu$ mhos
Grid No. 1 to Plate No. 2 .....	70 $\mu$ mhos
Grid No. 1 to Plate No. 3 .....	70 $\mu$ mhos

**NOTE:**

- (1) Shield No. 315 connected to cathode.

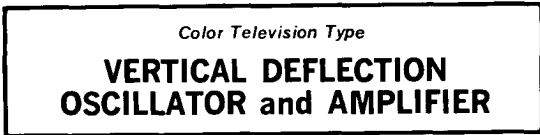

**Double Dissimilar Triode**

Construction .....	Compactron T-9
Base .....	Buttton 12 Pin, E12-70
Basing .....	12BM
Outline .....	9-58
Maximum Diameter .....	1.188 In.
Maximum Seated Height .....	2.000 In.
Maximum Overall Height .....	2.375 In.

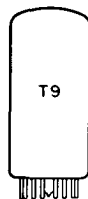
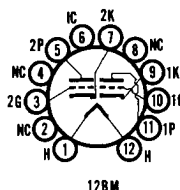

**ELECTRICAL DATA**  
**HEATER OPERATION**

Heater Voltage .....	6.3 Volts
Heater Current .....	900 Ma
Maximum Heater-Cathode Voltage	
Heater Negative with Respect to Cathode	
Total DC and Peak .....	200 Volts
Heater Positive with Respect to Cathode	
DC .....	100 Volts
Total DC and Peak .....	200 Volts



**DIRECT INTERELECTRODE CAPACITANCES (Unshielded)**

	<b>Section 1</b>	<b>Section 2</b>
Grid to Plate: (g to p) .....	3.8	5.0 Pf
Input: g to (h + k) .....	2.2	4.0 Pf
Output: p to (h + k) .....	0.48	0.54 Pf

**RATINGS (Design Maximum Rating System)**

	<b>Vertical Oscillator Service<sup>(1)</sup> (Section 1)</b>	<b>Vertical Deflection Amplifier<sup>(1)</sup> (Section 2)</b>
DC Plate Voltage (Max.) .....	350	550 Volts
Peak Positive Pulse Plate Voltage (Max.) .....	—	2500 Volts
Peak Negative Grid Voltage (Max.) .....	400	250 Volts
Plate Dissipation (Max.) .....	1.0	10 <sup>(2)</sup> Watts
DC Cathode Current (Max.) .....	—	50 Ma
Peak Cathode Current (Max.) .....	—	150 Ma
Grid Circuit Resistance		
With Fixed Bias .....	2.2	2.2 Megohms
With Cathode Bias .....	2.2	— Megohms

**CHARACTERISTICS AND TYPICAL OPERATION**

	<b>Section 1 (Oscillator)</b>	<b>Section 2 (Amplifier)</b>
Plate Voltage .....	250	150 250 Volts
Grid Voltage .....	-8.0	0 <sup>(3)</sup> -9.5 Volts
Amplification Factor .....	22.5	— 15.4
Plate Resistance (Approx.) .....	9000	— 2000 Ohms
Transconductance .....	2500	— 7700 $\mu$ mhos
Plate Current .....	8.0	68 41 Ma
Grid Voltage (Approx.)		
I <sub>b</sub> = 10 $\mu$ a .....	-18	— Volts
Grid Voltage (Approx.)		
I <sub>b</sub> = 50 $\mu$ a .....	—	— -23 Volts

**NOTES:**

- (1) For operation in a 525 line, 30 frame system as described in "Standards of Good Engineering Practice for Television Broadcast Stations; Federal Communications Commission," the duty cycle of the voltage pulse must not exceed 15% of one horizontal scanning cycle.
- (2) In stages operating with grid-leak bias, an adequate cathode-bias resistor or other suitable means is required to protect the device in the absence of excitation.
- (3) Applied for short interval (two seconds maximum) so as not to damage device.

Color Television Type

**VERTICAL DEFLECTION  
OSCILLATOR and AMPLIFIER**

**6FM7**

13FM7, 15FM7

**Double Dissimilar Triode**

- Construction..... Compactron T-9  
 Base..... Button 12 Pin, E12-70  
 Basing..... 12EJ  
 Outline..... 9-58  
 Maximum Diameter..... 1.188 In.  
 Maximum Seated Height..... 2.000 In.  
 Maximum Overall Height..... 2.375 In.

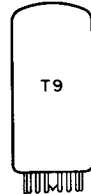
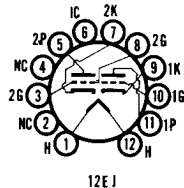

**ELECTRICAL DATA  
HEATER OPERATION**

	<b>15FM7</b>	<b>13FM7</b>	<b>6FM7</b>
Heater Voltage.....	14.8	13.0	6.3 Volts
Heater Current.....	450	450	1005 Ma
Heater Warm-up Time .....	11	11	— Seconds
Maximum Heater-Cathode Voltage			
Heater Negative with Respect to Cathode			
Total DC and Peak.....			200 Volts
Heater Positive with Respect to Cathode			
DC .....			100 Volts
Total DC and Peak.....			200 Volts

**DIRECT INTERELECTRODE CAPACITANCES (Unshielded)**

	<b>Section No. 1</b>	<b>Section No. 2</b>
Grid to Plate .....	4.0	7.0 Pf
Input: g to (h + k) .....	2.4	7.0 Pf
Output: p to (h + k) .....	0.40	1.1 Pf

**RATINGS (Design Maximum Rating System)  
Vertical Deflection Oscillator and Amplifier<sup>(1)</sup>**

	Section <sup>(2)</sup> No. 1 Oscillator	Section <sup>(2)</sup> No. 2 Amplifier
Plate Voltage (Max.) .....	350	550 Volts
Peak Positive Pulse Plate Voltage (Max.) .....	—	1500 Volts
Peak Negative Pulse Grid Voltage (Max.) .....	400	250 Volts
Plate Dissipation (Max.) <sup>(3)</sup> .....	1.0	10 Watts
Average Cathode Current (Max.) .....	—	50 Ma
Peak Cathode Current (Max.) .....	—	175 Ma
Grid Circuit Resistance, Self Bias (Max.) .....	2.2	2.2 Megohms

**AVERAGE PLATE CHARACTERISTICS  
(Section No. 1)**

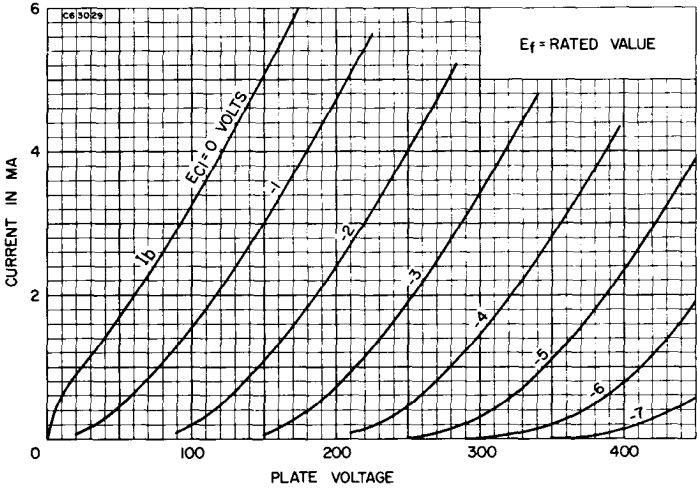

**AVERAGE PLATE CHARACTERISTICS  
(Section No. 2)**

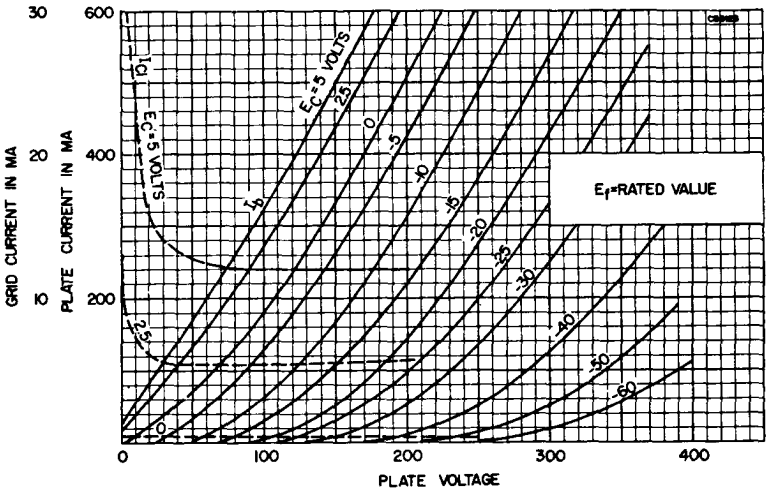

**CHARACTERISTICS AND TYPICAL OPERATION**

	Section No. 1	Section No. 2
Plate Voltage .....	250	175 Volts
Grid No. 1 Voltage .....	-3	-25 Volts
Plate Current .....	2.0	40 Ma
Transconductance .....	2200	6000 $\mu$ mhos
Amplification Factor .....	66	5.5
Plate Resistance (Approx.) .....	30,000	920 Ohms
Ec for Ib = 20 $\mu$ a (Approx.) .....	-5.3	- Volts
Ec for Ib = 200 $\mu$ a (Approx.) .....	—	-45 Volts

**NOTES:**

- (1) For operation in a 525 line, 30 frame system as described in "Standards of Good Engineering Practice for Television Broadcast Stations; Federal Communications Commission," the duty cycle of the voltage pulse not to exceed 15% of one horizontal scanning cycle.
- (2) Section No. 1 connects to Pins 6, 7 and 8. Section No. 2 connects to Pins 1, 2, 3, and 9.
- (3) In stages operating with grid leak bias, an adequate bias resistor or other suitable means is required to protect the tube in the absence of excitation.

**FM DETECTOR  
AF AMPLIFIER**

**6FM8**

**Double Diode and High Mu Triode**

Construction ..... Miniature T-6½  
 Base ..... Button, 9 Pin, E9-1  
 Basing ..... 9KR  
 Outline ..... 6-2  
 Maximum Diameter ..... 0.875 In.  
 Maximum Seated Height ..... 1.937 In.  
 Maximum Overall Height ..... 2.187 In.

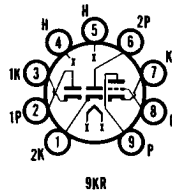

**ELECTRICAL DATA**

**HEATER OPERATION**

Heater Voltage .....	6.3 Volts
Heater Current .....	450 Ma
Maximum Heater-Cathode Voltage	
Heater Negative with Respect to Cathode	
Total DC and Peak .....	200 Volts
Heater Positive with Respect to Cathode	
DC .....	100 Volts
Total DC and Peak .....	200 Volts

**DIRECT INTERELECTRODE CAPACITANCES (Unshielded)**

**Triode**

Grid to Plate .....	1.8 Pf
Input: g to (h + Tk) .....	1.5 Pf
Output: p to (h + Tk) .....	0.16 Pf

**Diodes**

No. 1 Diode Plate to Grid .....	0.05 Pf
No. 2 Diode Plate to Grid .....	0.04 Pf
No. 1 Diode Cathode to All .....	4.6 Pf
No. 2 Diode Cathode to All .....	4.8 Pf
No. 1 Diode Input .....	2.4 Pf
No. 2 Diode Input .....	2.2 Pf

**RATINGS (Design Maximum Rating System)**

**Triode**

Plate Voltage (Max.) .....	330 Volts
Positive DC Grid Voltage (Max.) .....	0 Volt
Plate Dissipation (Max.) .....	1.1 Watts

**Diodes (Continuous Operation)**

DC Current, Each Plate (Max.) .....	5 Ma
-------------------------------------	------

**CHARACTERISTICS AND TYPICAL OPERATION**

**Triode: Class A1 Amplifier**

Plate Voltage .....	250 Volts
Grid Voltage .....	-3 Volts
Plate Current .....	1.0 Ma
Transconductance .....	1200 $\mu$ mhos
Amplification Factor .....	70
Plate Resistance (Approx.) .....	58,000 Ohms

**Diodes**

Average Current Each Plate at 5 Volts DC <sup>(1)</sup> .....	20 Ma
---	-------

**NOTE:**

- (1) Test condition only.

# 6FS5

2FS5, 3FS5

# VHF AMPLIFIER

**Shadow-Grid Beam Pentode**

Construction ..... Miniature T-5½  
 Base ..... Button 7 Pin, E7-1  
 Basing ..... 7GA  
 Outline ..... 5-2  
 Maximum Diameter ..... 0.750 In.  
 Maximum Seated Height ..... 1.875 In.  
 Maximum Overall Height ..... 2.125 In.

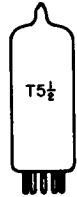
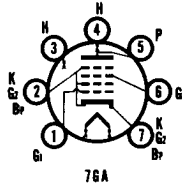

**ELECTRICAL DATA**

**HEATER OPERATION**

Heater Voltage.....	2.4	2.9	6FS5
Heater Current .....	600	450	6.3 Volts
Heater Warm-up Time .....	11	11	200 Ma
Maximum Heater-Cathode Voltage			— Seconds
Heater Negative with Respect to Cathode			
Total DC and Peak.....			200 Volts
Heater Positive with Respect to Cathode			
DC .....			100 Volts
Total DC and Peak.....			200 Volts

**DIRECT INTERELECTRODE CAPACITANCES**

	<b>Shielded <sup>(1)</sup></b>	<b>Unshielded</b>
Grid No. 1 to Plate: (g1 to p) .....	0.016	0.03 Pf
Input: g1 to (h + k + g2 + g3 + b.p.) .....	4.8	4.8 Pf
Output: p to (h + k + g2 + g3 + b.p.) .....	2.8	2.0 Pf
<b>RATINGS (Design Maximum Rating System)</b>		
Plate Voltage (Max.) .....		300 Volts
Screen Voltage (Max.) .....		150 Volts
Positive DC Grid-No. 1 Voltage (Max.) .....		0 Volt
Negative DC Grid-No. 1 Voltage (Max.) .....		50 Volts
Plate Dissipation (Max.) .....		3.25 Watts
Screen Dissipation (Max.) .....		0.15 Watt
DC Cathode Current (Max.) .....		20 Ma
Grid No. 1 Circuit Resistance		
Fixed Bias .....		0.5 Megohm

**CHARACTERISTICS AND TYPICAL OPERATION**

Plate Voltage .....	275 Volts
Screen Voltage .....	135 Volts
Grid No. 1 Voltage .....	-0.2 Volt
Plate Resistance (Approx.) .....	0.24 Megohm
Transconductance .....	10,000 μmhos
Plate Current .....	9 Ma
Screen Current .....	0.17 Ma
Grid No. 1 Voltage (Approx.) .....	
Gm = 100 μmhos .....	-5 Volts

**NOTE:**

(1) With external shield (EIA 316) connected to pin 7.

# 6FV6

2FV6

# VHF AMPLIFIER

**Sharp Cutoff Tetrode**

Construction ..... Miniature T-5½  
 Base ..... Button 7 Pin, E7-1  
 Basing ..... 7FQ  
 Outline ..... 5-2  
 Maximum Diameter ..... 0.750 In.  
 Maximum Seated Height ..... 1.875 In.  
 Maximum Overall Height ..... 2.125 In.

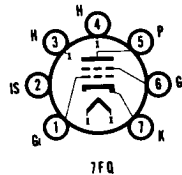

**ELECTRICAL DATA  
HEATER OPERATION**

	<b>2FV6</b>	<b>6FV6</b>
Heater Voltage .....	2.4	6.3 Volts
Heater Current .....	600	200 Ma
Heater Warm-up Time .....	11	— Seconds
Maximum Heater-Cathode Voltage		
Heater Negative with Respect to Cathode		
Total DC and Peak .....		200 Volts
Heater Positive with Respect to Cathode		
DC .....		100 Volts
Total DC and Peak .....		200 Volts

**DIRECT INTERELECTRODE CAPACITANCES (Shielded)<sup>(1)</sup>**

Grid No. 1 to Plate (Max.) .....	0.03 Pf
Input .....	4.5 Pf
Output .....	3.0 Pf

**RATINGS (Design Maximum Rating System)**

Plate Voltage (Max.) .....	275 Volts
Grid No. 2 Supply Voltage (Max.) .....	180 Volts
Grid No. 2 Voltage .....	See Rating Chart (Gen. Info. Sec.)
Positive Grid No. 1 Voltage (Max.) .....	0 Volt
Plate Dissipation (Max.) .....	2.0 Watts
Grid No. 2 Input (Max.) .....	0.5 Watt
Cathode Current (Max.) .....	20 Ma
Grid No. 1 Circuit Resistance (Self Bias) (Max.) .....	0.5 Megohm

**CHARACTERISTICS AND TYPICAL OPERATION**

Plate Voltage .....	125 Volts
Grid No. 2 Voltage .....	80 Volts
Grid No. 1 Voltage .....	-1 Volt
Plate Current .....	10 Ma
Grid No. 2 Current .....	1.5 Ma
Transconductance .....	8000 $\mu$ mhos
Plate Resistance .....	0.1 Megohm
Grid No. 1 Voltage for $I_b = 20 \mu$ a .....	-6 Volts

**NOTE:**

(1) Shield No. 316 connected to cathode.

**VERTICAL DEFLECTION OSC. (T)  
IF/GEN. PURPOSE AMP. (P)**

**6FV8A**  
5FV8

**Medium Mu Triode and  
Sharp Cutoff Pentode**

Construction .....	Miniature T-6 $\frac{1}{2}$
Base .....	Button 9 Pin, E9-1
Basing .....	9FA
Outline .....	6-2
Maximum Diameter .....	0.875 In.
Maximum Seated Height .....	1.937 In.
Maximum Overall Height .....	2.187 In.

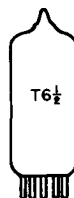
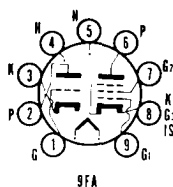

**ELECTRICAL DATA  
HEATER OPERATION**

	<b>5FV8</b>	<b>6FV8A</b>
Heater Voltage .....	4.7	6.3 Volts
Heater Current .....	600	450 Ma
Heater Warm-up Time .....	11	11 Seconds
Maximum Heater-Cathode Voltage		
Heater Negative with Respect to Cathode		
Total DC and Peak .....		200 Volts
Heater Positive with Respect to Cathode		
DC .....		100 Volts
Total DC and Peak .....		200 Volts

**DIRECT INTERELECTRODE CAPACITANCES**

	Shielded <sup>(1)</sup>	Unshielded
<b>Triode Section</b>		
Grid to Plate .....	1.8	1.8 Pf
Input: g to (h + Tk + IS) .....	2.8	2.8 Pf
Output: p to (h + Tk + IS) .....	2.0	1.5 Pf
<b>Pentode Section</b>		
Grid No. 1 to Plate (Max.) .....	0.010	0.020 Pf
Input: g1 to (h + Pk + g2 + g3 + IS) .....	5.0	5.0 Pf

Output: p to (h + Pk + g2 + g3 + IS) .....	3.0	2.0 Pf
Pentode Plate to Triode Plate (Max.) .....	0.03	0.15 Pf

**RATINGS (Design Maximum Rating System)**

	Tri. Sec. Vert. Defl. Osc. <sup>(2)</sup>	Pent. Sec. Class A Amp.
Plate Voltage (Max.) .....	330	330 Volts
Grid No. 2 Supply Voltage (Max.) .....	—	330 Volts
Grid No. 2 Voltage .....	See Rating Chart (Gen. Info. Sec.)	
Positive Grid No. 1 Voltage (Max.) .....	—	0 Volt
Peak Negative Pulse Grid Voltage (Max.) .....	250	— Volts
Average Cathode Current (Max.) .....	20	— Ma
Peak Cathode Current (Max.) .....	70	— Ma
Plate Dissipation (Max.) <sup>(3)</sup> .....	2.0	2.3 Watts
Grid No. 2 Dissipation (Max.) .....	—	0.55 Watt
Grid No. 1 Circuit Resistance		
Fixed Bias (Max.) .....	—	0.25 Megohm
Self Bias (Max.) .....	3.0 <sup>(3)</sup>	1.0 Megohm

**CHARACTERISTICS AND TYPICAL OPERATION**

	Triode Section	Pentode Section
Plate Voltage .....	125	125 Volts
Grid No. 2 Voltage .....	—	125 Volts
Grid No. 1 Voltage .....	-1.0	-1.0 Volt
Transconductance .....	8000	6500 $\mu$ mhos
Plate Current .....	12.0	12.0 Ma
Grid No. 2 Current .....	—	4.0 Ma
Plate Resistance (Approx.) .....	5600	200,000 Ohms
Amplification Factor .....	45	—
E <sub>c1</sub> for I <sub>b</sub> = 20 $\mu$ a (Approx.) .....	-7.5	-9 Volts

**NOTES:**

- (1) Shield No. 315 tied to Pin No. 4.
- (2) For operation in a 525 line, 30 frame system as described in "Standards of Good Engineering Practice for Television Broadcast Stations; Federal Communications Commission," the duty cycle of the voltage pulse must not exceed 15% of one horizontal scanning cycle.
- (3) In stages operating with grid leak bias, an adequate bias resistor or other suitable means is required to protect the tube in the absence of excitation.



**High Mu Triode**

Construction .....	Miniature T-5½
Base .....	Button 7 Pin, E7-1
Basing .....	.7FP
Outline .....	5-2
Maximum Diameter .....	0.750 In.
Maximum Seated Height .....	1.875 In.
Maximum Overall Height .....	2.125 In.

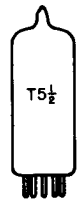
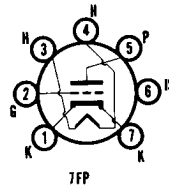

**ELECTRICAL DATA  
HEATER OPERATION**

	2FY5	3FY5	6FY5
Heater Voltage .....	2.4	3.1	6.3 Volts
Heater Current .....	600	450	200 Ma
Maximum Heater Cathode Voltage .....			100 Volts

**DIRECT INTERELECTRODE CAPACITANCES**

	Unshielded	Shielded
Input .....	4.75	4.75 Pf
Output .....	3.3	4.3 Pf
Grid to Heater (Max.) .....	0.28	0.28 Pf
Plate to Cathode .....	0.25	0.21 Pf
Grid to Cathode .....	3.2	3.2 Pf
Cathode to Heater .....	2.5	2.5 Pf
Plate to Grid .....	0.50	0.48 Pf

**RATINGS (Absolute Maximum Rating System)**

Plate Voltage (Max.) .....	200 Volts
Plate Voltage (Zero Plate Current) (Max.) .....	550 Volts
Plate Dissipation (Max.) .....	2.2 Watts

Cathode Current (Max.).....	20 Ma
Negative Grid Voltage (Max.) .....	50 Volts
Grid Circuit Resistance (Max.) .....	1 Megohm
Cathode-Heater Circuit Resistance (Max.) .....	20,000 Ohms

**CHARACTERISTICS AND TYPICAL OPERATION**

Plate Voltage .....	135	135	135	135 Volts
Negative Grid Bias.....	1	3.1	5	4.5 Volts
Plate Current .....	11	—	—	0.1 Ma
Transconductance .....	13,000	625	125	— $\mu$ mhos
Amplification Factor .....	70	—	—	—

**VERTICAL DEFLECTION  
OSCILLATOR and AMPLIFIER**

**6FY7**  
11FY7, 15FY7

**Double Dissimilar Triode**

Construction..... Compactron T-9  
 Base ..... Button 12 Pin, E12-70  
 Basing ..... 12EO  
 Outline ..... 9-60  
 Maximum Diameter ..... 1.188 In.  
 Maximum Seated Height ..... 2.500 In.  
 Maximum Overall Height ..... 2.875 In.

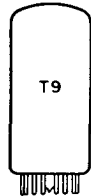
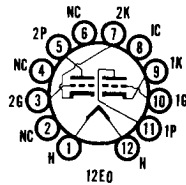

**ELECTRICAL DATA  
HEATER OPERATION**

	15FY7	11FY7	6FY7
Heater Voltage.....	14.7	11.0	6.3 Volts
Heater Current .....	450	600	1050 Ma
Heater Warm-up Time .....	11	11	— Seconds
Maximum Heater-Cathode Voltage			
Heater Negative with Respect to Cathode			
Total DC and Peak.....			200 Volts
Heater Positive with Respect to Cathode			
DC .....			100 Volts
Total DC and Peak.....			200 Volts

**DIRECT INTERELECTRODE CAPACITANCES (Unshielded)**

	Section 1	Section 2
Grid to Plate: (g to p) .....	4.4	9.5 Pf
Input: g to (h + k) .....	2.2	6.5 Pf
Output: p to (h + k) .....	0.4	1.2 Pf

**RATINGS (Design Maximum Rating System)**

	Vertical Oscillator Service <sup>(1)</sup> (Section 1)	Vertical Deflection Amplifier <sup>(1)</sup> (Section 2)
DC Plate Voltage (Max.) .....	330	275 Volts
Peak Positive Pulse Plate Voltage (Max.) .....	—	2000 Volts
Peak Negative Grid Voltage (Max.) .....	400	250 Volts
Plate Dissipation (Max.) .....	1.0	7.0 <sup>(2)</sup> Watts
DC Cathode Current (Max.) .....	20	50 Ma
Peak Cathode Current (Max.) .....	70	175 Ma
Grid Circuit Resistance (Max.).....	2.2	2.2 Megohms

**CHARACTERISTICS AND TYPICAL OPERATION**

	Section 1 (Oscillator)	Section 2 (Amplifier)
Plate Voltage .....	250	60
Grid Voltage .....	-3.0	0 <sup>(3)</sup>
Amplification Factor .....	65	—
Plate Resistance (Approx.) .....	40,500	—
Transconductance .....	1600	—
Plate Current .....	1.4	95
Plate Current (Approx.) $E_c = -25$ Volts.....	—	—
Grid Voltage (Approx.) $I_b = 30 \mu a$ .....	-5.5	—
Grid Voltage (Approx.) $I_b = 50 \mu a$ .....	—	—

**NOTES:**

- (1) For operation in a 525 line, 30 frame system as described in "Standards of Good Engineering Practice for Television Broadcast Stations; Federal Communications Commission," the duty cycle of the voltage pulse must not exceed 15% of one horizontal scanning cycle.
- (2) In stages operating with grid-leak bias, an adequate cathode-bias resistor or other suitable means is required to protect the tube in the absence of excitation.
- (3) Applied for short interval (two seconds maximum) so as not to damage tube.

**6G11**  
12G11

**FM DETECTOR  
AUDIO POWER AMPLIFIER**

**Double Dissimilar Pentode**

Construction..... Compactron T-9  
Base ..... Button 12 Pin, E12-70  
Basing ..... 12BU  
Outline ..... 9.58  
Maximum Diameter ..... 1.188 In.  
Maximum Seated Height ..... 2.000 In.  
Maximum Overall Height ..... 2.375 In.

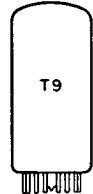
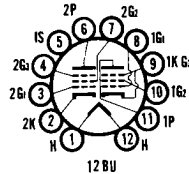

**ELECTRICAL DATA**

**HEATER OPERATION**

	<b>12G11</b>	<b>6G11</b>
Heater Voltage .....	12.6	6.3 Volts
Heater Current .....	600	1200 Ma
Heater Warm-up Time .....	11	— Seconds
Maximum Heater-Cathode Voltage		
Heater Negative with Respect to Cathode		
Total DC and Peak .....		200 Volts
Heater Positive with Respect to Cathode		
DC .....		100 Volts
Total DC and Peak .....		200 Volts

**DIRECT INTERELECTRODE CAPACITANCES (Unshielded)**

**Section 1**

Grid No. 1 to Plate .....	0.26 Pf
Input: 1g1 to (h + 1k + 1g2 + bp + IS) .....	12 Pf
Output: 1p to (h + 1k + 1g2 + bp + IS) .....	12 Pf

**Section 2**

Grid No. 1 to Plate .....	0.034 Pf
Grid No. 3 to Plate .....	2.8 Pf
Grid No. 1 to All Except Plate: 2g1 to (h + 2k + 2g2 + 2g3 + IS) .....	6.5 Pf
Grid No. 3 to All: 2g3 to (h + 2k + 2g1 + 2g2 + 2p + IS) .....	7.5 Pf
Grid No. 1 to Grid No. 3 .....	0.24 Pf
Plate, Section 1 to Plate, Section 2 .....	0.12 Pf

**RATINGS (Design Maximum Rating System)**

**Section 1**

Plate Voltage .....	150 Volts
Screen Voltage .....	135 Volts
Plate Dissipation .....	6.5 Watts
Screen Dissipation .....	1.8 Watts
DC Cathode Current .....	65 Ma

**Section 2**

Plate Voltage .....	330 Volts
Suppressor Voltage .....	28 Volts
Screen Supply Voltage .....	330 Volts
Screen Voltage .....	See Rating Chart (Gen. Info. Sec.)
Positive DC Grid No. 1 Voltage .....	0 Volt
Plate Dissipation .....	1.7 Watts
Screen Dissipation .....	1.1 Watts

**CHARACTERISTICS AND TYPICAL OPERATION**

**Section 1**

**Class A1 Amplifier**

Plate Voltage .....	120 Volts
Screen Voltage .....	110 Volts
Grid No. 1 Voltage .....	-8.0 Volts
Peak AF Grid No. 1 Voltage .....	8.0 Volts
Plate Resistance (Approx.) .....	10,000 Ohms
Transconductance .....	7500 $\mu$ mhos
Zero Signal Plate Current .....	49 Ma
Maximum Signal Plate Current .....	50 Ma
Zero Signal Screen Current .....	4.0 Ma
Maximum Signal Screen Current .....	8.5 Ma
Load Resistance .....	2500 Ohms
Total Harmonic Distortion (Approx.) .....	10 Percent
Maximum Signal Power Output .....	2.3 Watts



**Section 2**

Plate Voltage .....	150 Volts
Suppressor Voltage .....	0 Volt
Screen Voltage .....	100 Volts
Cathode Bias Resistor .....	560 Ohms
Plate Resistance (Approx.) .....	0.15 Megohm
Grid No. 1 Transconductance .....	1000 $\mu$ mhos
Grid No. 3 Transconductance .....	400 $\mu$ mhos
Plate Current .....	1.3 Ma
Screen Current .....	2.0 Ma
Grid No. 1 Voltage (Approx.) $I_b = 10 \mu$ a .....	-4.5 Volts
Grid No. 3 Voltage (Approx.) $I_b = 10 \mu$ a .....	-4.5 Volts

**HORIZONTAL DEFLECTION  
AMPLIFIER**

**6GB5/EL500**  
13GB5/XL500, 18GB5,  
27GB5/PL500, 28GB5

**Beam Power Pentode**

Construction .....Magnoval T-9  
 Base .....Button 9 Pin E9-23  
 Top Cap .....C1-2  
 Basing.....9NH  
 Outline  
 Maximum Diameter .....1.188 In.  
 Maximum Seated Height .....3.750 In.  
 Maximum Overall Height .....4.125 In.

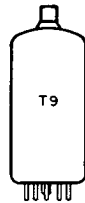
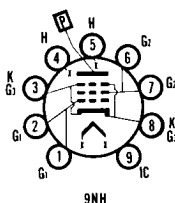

**ELECTRICAL DATA**

**HEATER OPERATION**

	28GB5	27GB5 /PL500	18GB5	13GB5 /XL500	6GB5 /EL500
Heater Voltage .....	28	28	18	13	6.3 Volts
Heater Current .....	300	300	450	600	1380 Ma
Maximum Heater-Cathode Voltage					
Heater Negative with Respect to Cathode					
DC .....					125 Volts
Total DC and Peak .....					250 Volts
Heater Positive with Respect to Cathode					
DC .....					125 Volts
Total DC and Peak .....					250 Volts

**RATINGS (Design Maximum Rating System)**

DC Plate Voltage (Max.) .....	275 Volts
Peak Positive Pulse Plate Voltage (Max.) .....	7700 Volts
Screen-Grid Voltage (Max.) .....	275 Volts
Average Cathode Current (Max.) .....	275 Ma
Plate Dissipation (Max.) .....	17 Watts
Screen-Grid Dissipation (Max.) .....	5 Watts
Control-Grid Circuit Resistance .....	2.2 Megohms

**CHARACTERISTICS AND TYPICAL OPERATION**

Supply Voltage .....	170	200	230 Volts
Minimum Value of Screen-Grid Resistor <sup>(1)</sup> .....	1.2	1.5	2.2 Kilohms
Screen-Grid Voltage .....	130	150	180 Volts
Plate Voltage at End of Scan <sup>(2)</sup> .....	55	59	65 Volts
Control-Grid Voltage at End of Scan <sup>(3)</sup> .....	-10	-10	-10 Volts
Peak Plate Current .....	210	270	360 Ma
<b>Non-Stabilized Circuits (Drive Below the Knee)</b>			
Supply Voltage .....	170	200	230 Volts
Minimum Value of Screen-Grid Resistor .....	2.2	2.2	2.2 Kilohms
Control-Grid Voltage at End of Scan <sup>(3)</sup> .....	+1	+1	+1 Volt
Peak Plate Current <sup>(4)</sup> .....	200	250	320 Ma

**INSTANTANEOUS PLATE KNEE VALUES**

$E_b = 75$  V,  $E_{c2} = 200$  V and  $E_{c1} = -10$  V  
 $I_b = 440$  Ma and  $I_{c2} = 37$  Ma

**NOTES:**

- (1) The quoted values are the minimum values of  $R_{g2}$  which are required to prevent an excessive screen-grid dissipation during the warm-up period.
- (2) These values refer to nominal line voltage. At a line voltage 10% below nominal the tube will still operate above the knee.
- (3) The minimum required control-grid voltage for cut-off during the flyback is -120 volts.
- (4) To allow for tube spread, deterioration during the life and line voltage 10% below nominal, the specified values for peak plate current should not be exceeded at the specified conditions for a nominal line voltage.

# 6GC5

## Color Television Type AUDIO POWER AMPLIFIER

**Beam Power Pentode**

Construction .....9T-9  
 Base .....Button 9 Pin, E9-68  
 Basing .....9EU  
 Outline .....9-71  
 Maximum Diameter .....1.188 In.  
 Maximum Seated Height .....2.920 In.  
 Maximum Overall Height .....3.230 In.

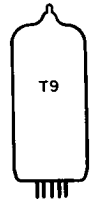
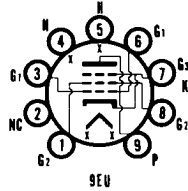

**ELECTRICAL DATA**

**HEATER OPERATION**

Heater Voltage.....	6.3 Volts
Heater Current.....	1200 Ma
Maximum Heater-Cathode Voltage	
Heater Negative with Respect to Cathode	
Total DC and Peak.....	200 Volts
Heater Positive with Respect to Cathode	
DC.....	100 Volts
Total DC and Peak.....	200 Volts

**DIRECT INTERELECTRODE CAPACITANCES (Unshielded)**

Grid No. 1 to Plate.....	0.9 Pf
Input: g1 to (h + k, g3 + g2).....	18 Pf
Output: p to (h + k, g3 + g2).....	7 Pf

**RATINGS (Design Maximum Rating System)**

Plate Voltage (Max.).....	220 Volts
Grid No. 2 Voltage (Max.).....	140 Volts
Plate Dissipation (Max.).....	12 Watts
Grid No. 2 Dissipation (Max.).....	1.4 Watts
Grid No. 1 Circuit Resistance	
Fixed Bias (Max.).....	0.1 Megohm
Cathode Bias (Max.).....	0.5 Megohm

**CHARACTERISTICS AND TYPICAL OPERATION**

**Class A1 Amplifier (Single Tube)**

Plate Voltage.....	110	200 Volts
Grid No. 2 Voltage.....	110	125 Volts
Grid No. 1 Voltage.....	-7.5	— Volts
Cathode Resistor.....	—	180 Ohms
Peak AF Grid No. 1 Voltage.....	7.5	8.5 Volts
Zero Signal Plate Current.....	49	46 Ma
Maximum Signal Plate Current.....	50	47 Ma
Zero Signal Grid No. 2 Current.....	4	2.2 Ma
Maximum Signal Grid No. 2 Current.....	10	8.5 Ma
Transconductance.....	8000	8000 μmhos
Plate Resistance (Approx.).....	13,000	28,000 Ohms
Load Resistance.....	2000	4000 Ohms
Maximum Signal Power Output.....	2.1	3.8 Watts
Total Harmonic Distortion (Approx.).....	10	10 Percent

# 6GE5

12GE5, 17GE5

## Color Television Type HORIZONTAL DEFLECTION AMPLIFIER

**Beam Power Pentode**

Construction .....Compactron T-12  
 Base .....Button 12 Pin, E12-74  
 Basing .....12BJ  
 Outline .....12-56  
 Maximum Diameter .....1.563 In.  
 Maximum Seated Height .....2.500 In.  
 Maximum Overall Height .....2.875 In.

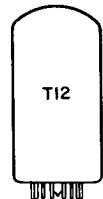
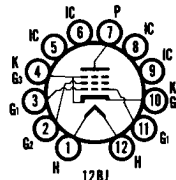

**ELECTRICAL DATA  
HEATER OPERATION**

	17GE5	12GE5	6GE5
Heater Voltage.....	16.8	12.6	6.3 Volts
Heater Current .....	450	600	1200 Ma
Heater Warm-up Time .....	11	11	— Seconds
Maximum Heater-Cathode Voltage			
Heater Negative with Respect to Cathode			
Total DC and Peak.....			200 Volts
Heater Positive with Respect to Cathode			
DC .....			100 Volts
Total DC and Peak.....			200 Volts

**DIRECT INTERELECTRODE CAPACITANCES (Unshielded)**

Grid No. 1 to Plate .....	0.34 Pf
Input .....	16 Pf
Output .....	7 Pf

**RATINGS (Design Maximum Rating System)**

**Horizontal Deflection Amplifier<sup>(1)</sup>**

DC Plate Supply Voltage (Boost + DC Power Supply) (Max.) .....	770 Volts
Peak Positive Pulse Plate Voltage (Abs. Max.) .....	6500 Volts
Peak Negative Pulse Plate Voltage (Max.) .....	1500 Volts
Plate Dissipation (Max.) <sup>(2)</sup> .....	17.5 Watts
Peak Negative Grid No. 1 Voltage (Max.) .....	330 Volts
Grid No. 2 Voltage (Max.) .....	220 Volts
Grid No. 2 Dissipation (Max.) .....	3.5 Watts
Average Cathode Current (Max.) .....	175 Ma
Peak Cathode Current (Max.) .....	550 Ma
Grid No. 1 Circuit Resistance (Max.) .....	1.0 Megohm
Bulb Temperature (At Hottest Point) (Max.) .....	220°C

**CHARACTERISTICS AND TYPICAL OPERATION**

Plate Voltage .....	5000	250 Volts
Grid No. 2 Voltage .....	150	150 Volts
Grid No. 1 Voltage .....	—	-22.5 Volts
Plate Current .....	—	65 Ma
Grid No. 2 Current .....	—	1.8 Ma
Transconductance .....	—	7300 μmhos
Plate Resistance.....	—	18,000 Ohms
Amplification Factor <sup>(3)</sup> .....	—	4.4
E <sub>c1</sub> for I <sub>b</sub> = 1.0 Ma (Approx.) .....	-100	-42 Volts

**INSTANTANEOUS PLATE KNEE VALUES**

E<sub>b</sub> = 60 V; E<sub>c2</sub> = 150 V and E<sub>c1</sub> = 0

I<sub>b</sub> = 345 Ma, and I<sub>c2</sub> = 27 Ma

**NOTES:**

- (1) For operation in a 525 line, 30 frame system as described in "Standards of Good Engineering Practice for Television Broadcast Stations; Federal Communications Commission," the duty cycle of the voltage pulse is not to exceed 15% of one horizontal scanning cycle.
- (2) In stages operating with grid leak bias, an adequate cathode bias resistor or other suitable means is required to protect the tube in the absence of excitation.
- (3) Amplification factor with tube operating as a triode with 150 volts on the plate and Grid No. 2 and -22.5 volts on Grid No. 1.

**HORIZONTAL DEFLECTION  
AMPLIFIER**

**6GF5**

**Beam Power Pentode**

Construction.....	Compactron T-9
Base .....	Buttun 12 Pin, E12-70
Basing .....	12BJ
Outline .....	9-60
Maximum Diameter .....	1.188 In.
Maximum Seated Height .....	2.500 In.
Maximum Overall Height .....	2.875 In.

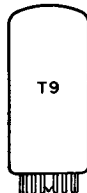
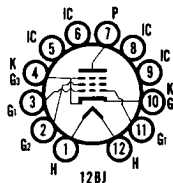

**ELECTRICAL DATA  
HEATER OPERATION**

Heater Voltage.....	6.3 Volts
Heater Current .....	1200 Ma
Maximum Heater-Cathode Voltage	
Heater Negative with Respect to Cathode	
Total DC and Peak.....	200 Volts

Heater Positive with Respect to Cathode

DC .....	100 Volts
Total DC and Peak.....	200 Volts

**DIRECT INTERELECTRODE CAPACITANCES (Unshielded)**

Grid No. 1 to Plate .....	0.2 Pf
Input: g1 to (h + k + g2 + b.p.) .....	16 Pf
Output: p to (h + k + g2 + b.p.) .....	7.5 Pf

**RATINGS (Design Maximum Rating System)**

**Horizontal-Deflection Amplifier Service<sup>(1)</sup>**

DC Plate-Supply Voltage (Boost + DC Power Supply) (Max.) .....	770 Volts
Peak Positive Pulse Plate Voltage (Max.) .....	5000 Volts
Peak Negative Pulse Plate Voltage (Max.) .....	1500 Volts
Screen Voltage (Max.) .....	220 Volts
Negative DC Grid No. 1 Voltage (Max.) .....	55 Volts
Peak Negative Grid No. 1 Voltage (Max.) .....	330 Volts
Plate Dissipation (Max.) <sup>(2)</sup> .....	9.0 Watts
Screen Dissipation (Max.) .....	2.5 Watts
DC Cathode Current (Max.) .....	160 Ma
Peak Cathode Current (Max.) .....	500 Ma
Grid No. 1 Circuit Resistance (Max.) .....	1.0 Megohm
Bulb Temperature at Hottest Point (Max.) .....	200 °C

**CHARACTERISTICS AND TYPICAL OPERATION**

Plate Voltage .....	250 Volts
Screen Voltage .....	150 Volts
Grid No. 1 Voltage .....	-26.5 Volts
Plate Resistance (Approx.) .....	260,000 Ohms
Transconductance .....	4700 μmhos
Plate Current .....	34 Ma
Screen Current .....	1.6 Ma
Grid No. 1 Voltage (Approx.) Ib = 1.0 Ma .....	-46 Volts
Triode Amplification Factor <sup>(4)</sup> .....	4.2

**INSTANTANEOUS PLATE KNEE VALUES<sup>(3)</sup>**

Eb = 60 V, Ec2 = 150 V, and Ec1 = 0 V  
Ib = 345 Ma and Ic2 = 27 Ma

**NOTES:**

- (1) For operation in a 525 line, 30 frame system as described in "Standards of Good Engineering Practice for Television Broadcast Stations; Federal Communications Commission," the duty cycle of the voltage pulse must not exceed 15% of one horizontal scanning cycle.
- (2) In stages operating with grid-leak bias, an adequate cathode-bias resistor or other suitable means is required to protect the tube in the absence of excitation.
- (3) Applied for short interval (two seconds maximum) so as not to damage tube.
- (4) Triode connection (screen tied to plate) with Eb = Ec2 = 150 volts and Ec1 = -26.5 volts.

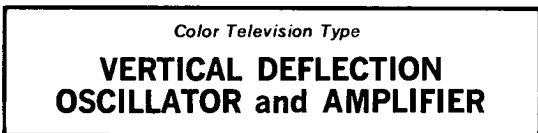

**Double Dissimilar Triode**

Construction .....Novar T-9  
Base .....Novar Button 9 Pin, E9-75  
Basing .....9QD  
Outline

Maximum Diameter .....1.188 In.  
Maximum Seated Height .....2.620 In.  
Maximum Overall Height .....3.000 In.

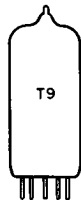
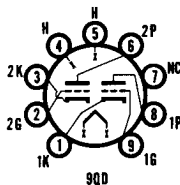

**ELECTRICAL DATA**

**HEATER OPERATION**

	13GF7	10GF7	6GF7
Heater Voltage.....	13.0	9.7	6.3 Volts
Heater Current .....	450	600	985 Ma
Heater Warm-up Time .....	11	11	— Seconds
Maximum Heater-Cathode Voltage			
Heater Negative with Respect to Cathode			
Total DC and Peak.....	200 Volts		
Heater Positive with Respect to Cathode			
DC .....	100 Volts		
Total DC and Peak.....	200 Volts		

**DIRECT INTERELECTRODE CAPACITANCES (Unshielded)**

	Section No. 1	Section No. 2
Grid to Plate .....	4.6	9.0 Pf
Input: g to (h + k) .....	2.4	6.5 Pf
Output: p to (h + k) .....	0.26	1.4 Pf

**RATINGS (Design Maximum Rating System)  
Vertical Deflection Oscillator and Amplifier<sup>(1)</sup>**

	Section No. 1 Oscillator	Section No. 2 Amplifier
DC Plate Voltage (Max.) .....	330	330 Volts
Peak Positive Pulse Plate Voltage (Abs. Max.) .....	—	1500 Volts
Peak Negative Pulse Grid Voltage (Max.) .....	400	250 Volts
Plate Dissipation (Max.) <sup>(2)</sup> .....	1.5	10 Watts
Average Cathode Current (Max.) .....	22	50 Ma
Peak Cathode Current (Max.) .....	77	175 Ma
Grid Circuit Resistance (Self Bias) (Max.) .....	2.2	2.2 Megohms

**CHARACTERISTICS AND TYPICAL OPERATION**

	Section No. 1 <sup>(3)</sup>	Section No. 2 <sup>(3)</sup>
Plate Voltage .....	250	150 Volts
Grid No. 1 Voltage .....	-3	-20 Volts
Plate Current .....	1.4	50 Ma
Transconductance .....	1600	7200 $\mu$ mhos
Amplification Factor .....	64	5.4
Plate Resistance (Approx.) .....	40,000	750 Ohms
Ec for Ib = 10 $\mu$ a (Approx.) .....	-5.5	— Volts
Ec for Ib = 100 $\mu$ a (Approx.) .....	—	-45 Volts
Ib at Ec = -28 Vdc (Approx.) .....	—	10 Ma

**INSTANTANEOUS PLATE KNEE VALUES (Section No. 2)**

Eb = 60 V; Ec = 0; Ib = 95 Ma

**NOTES:**

- (1) For operation in a 525 line, 30 frame system as described in "Standards of Good Engineering Practice for Television Broadcast Stations; Federal Communications Commission," the duty cycle of the voltage pulse must not exceed 15% of one horizontal scanning cycle.
- (2) In stages operating with grid-leak bias, an adequate bias resistor or other suitable means is required to protect the tube in the absence of excitation.
- (3) Section No. 1 connects to Pins 4, 5, and 6.

**AVERAGE PLATE CHARACTERISTICS  
(Section No. 1)**

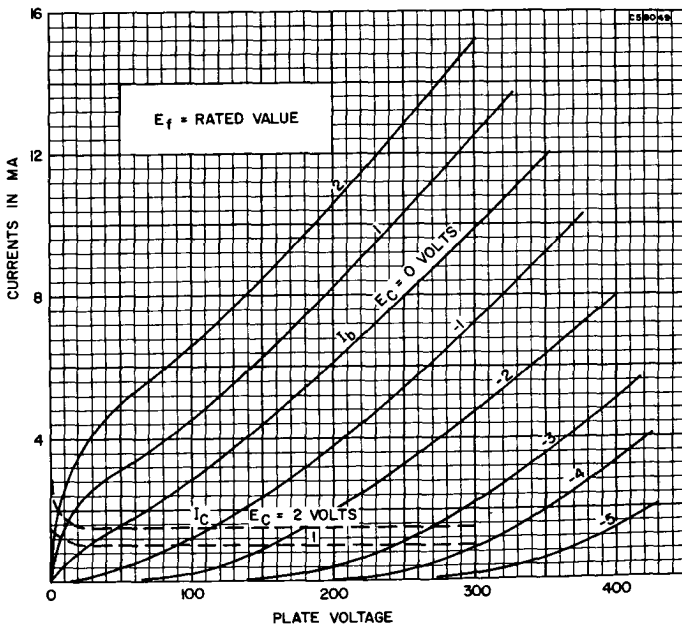

**AVERAGE PLATE CHARACTERISTICS**  
(Section No. 2)

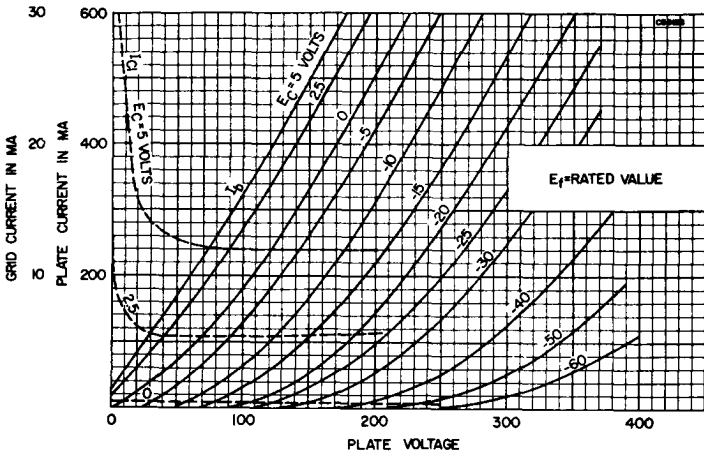

**6GF7A**

10GF7A, 13GF7A

Color Television Type

**VERTICAL DEFLECTION  
OSCILLATOR and AMPLIFIER**

**Double Dissimilar Triode**

Construction .....Novar T-9  
Base .....Novar Button 9 Pin, E9-89  
(Exhaust Tip on Base)  
Basing .....9QD  
Outline .....9-107  
Maximum Diameter .....1.188 in.  
Maximum Seated Height .....2.000 in.  
Maximum Overall Height .....2.380 in.  
The 6GF7A, 10GF7A, and 13GF7A are identical to the 6GF7, 10GF7, and 13GF7 except for base with exhaust tip at bottom and shorter bulb.

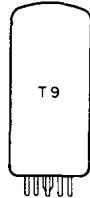
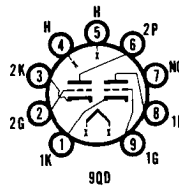

**6GJ5**

12GJ5, 17GJ5

**HORIZONTAL DEFLECTION  
AMPLIFIER**

**Beam Power Pentode**

Construction .....Novar T-12  
Base .....Novar Button 9 Pin, E9-76  
Top Cap .....C1-2, C1-3 or C1-33  
Basing .....9QK  
Outline .....12-70  
Maximum Diameter .....1.562 in.  
Maximum Seated Height .....3.170 in.  
Maximum Overall Height .....3.550 in.

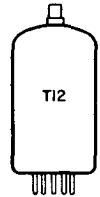
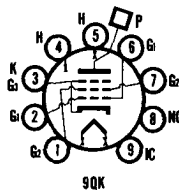

**ELECTRICAL DATA  
HEATER OPERATION**

Heater Voltage.....  
Heater Current .....  
Heater Warm-up Time .....

<b>17GJ5</b>	<b>12GJ5</b>
16.8	12.6
450	600
11	11

**6GJ5**  
6.3 Volts  
1200 Ma  
— Seconds

Maximum Heater-Cathode Voltage	
Heater Negative with Respect to Cathode	
Total DC and Peak.....	200 Volts
Heater Positive with Respect to Cathode	
DC .....	100 Volts
Total DC and Peak .....	200 Volts

**DIRECT INTERELECTRODE CAPACITANCES (Unshielded)**

Grid to Plate .....	0.26 Pf
Input: $g_1$ to $(k + g_3 + g_2 + h)$ .....	15 Pf
Output: $p$ to $(k + g_3 + g_2 + h)$ .....	6.5 Pf

**RATINGS (Design Maximum Rating System)**

**Horizontal Deflection Amplifier<sup>(1)</sup>**

DC Plate Supply Voltage (Boost + DC Power Supply) (Max.) .....	770 Volts
Peak Positive Plate Voltage (Max.) .....	6500 Volts
Peak Negative Plate Voltage (Max.) .....	1500 Volts
Grid No. 2 Voltage (Max.) .....	220 Volts
Negative Grid No. 1 Voltage (Max.) .....	-55 Volts
Peak Negative Grid No. 1 Voltage (Max.) .....	330 Volts
Plate Dissipation (Max.) <sup>(2)</sup> .....	17.5 Watts
Grid No. 2 Input (Max.) .....	3.5 Watts
Average Cathode Current (Max.) .....	175 Ma
Peak Cathode Current (Max.) .....	550 Ma
Grid No. 1 Circuit Resistance (Max.) .....	1.0 Megohm
Bulb Temperature (At Hottest Point) (Max.) .....	240 °C

**CHARACTERISTICS AND TYPICAL OPERATION**

Plate Voltage .....	250 Volts
Grid No. 2 Voltage .....	150 Volts
Grid No. 1 Voltage .....	-22.5 Volts
Plate Current .....	70 Ma
Grid No. 2 Current .....	2.1 Ma
Transconductance .....	7100 $\mu$ mhos
Amplification Factor <sup>(3)</sup> .....	4.4
Plate Resistance .....	15,000 Ohms
$E_{c1}$ for $I_b = 1$ Ma (Approx.) .....	-42 Volts

**INSTANTANEOUS PLATE KNEE VALUES**

$E_b = 60$  V,  $E_{c2} = 150$  V and  $E_{c1} = 0$  V;  
 $I_b = 390$  Ma; and  $I_{c2} = 32$  Ma

**NOTES:**

- (1) For operation in a 525 line, 30 frame system as described in "Standards of Good Engineering Practice for Television Broadcast Stations; Federal Communications Commission," the duty cycle of the voltage pulse must not exceed 15% of one horizontal scanning cycle.
- (2) In stages operating with grid leak bias, an adequate cathode bias resistor or other suitable means is required to protect the tube in the absence of excitation.
- (3) Amplification factor with tube operating as a triode with 150 volts on the plate and Grid No. 2 and -22.5 volts on Grid No. 1.

**AVERAGE PLATE CHARACTERISTICS**

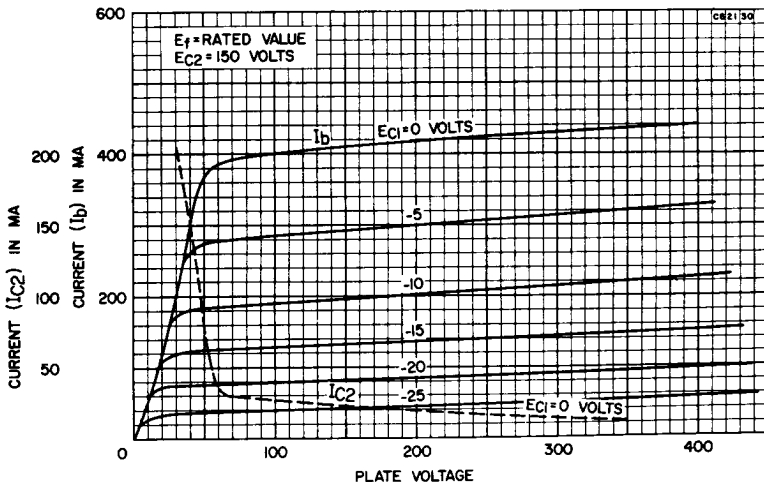

# 6GJ5A

12GJ5A, 17GJ5A

## HORIZONTAL DEFLECTION AMPLIFIER

**Beam Power Pentode**

Construction ..... Novar T-12  
 Base ..... Novar Button 9 Pin, E9-88  
 (Exhaust Tip on Base)  
 Top Cap ..... C1-2, C1-3 or C1-33  
 Basing ..... 9QK  
 Outline  
 Maximum Diameter ..... 1.562 In.  
 Maximum Seated Height ..... 3.125 In.  
 Maximum Overall Height ..... 3.505 In.  
 The 6GJ5A, 12GJ5A, and 17GJ5A are identical to the 6GJ5, 12GJ5, and 17GJ5 except for base with exhaust tip at bottom and shorter bulb.

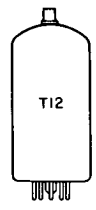
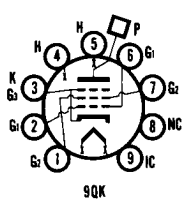

# 6GJ7/ECF801

4GJ7, 5GJ7, 8GJ7/PCF801

*Color Television Type*

## VHF OSCILLATOR and MIXER

**Triode and Pentode**

Construction ..... Miniature T-6½  
 Base ..... Button 9 Pin, E9-1  
 Basing ..... 9QA  
 Outline ..... 6-2  
 Maximum Diameter ..... 0.875 In.  
 Maximum Seated Height ..... 1.937 In.  
 Maximum Overall Height ..... 2.187 In.

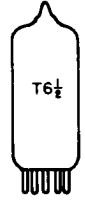
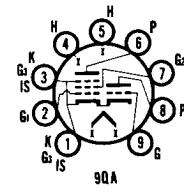

**ELECTRICAL DATA**

**HEATER OPERATION**

	4GJ7	5GJ7	8GJ7/PCF801	6GJ7/ECF801
Heater Voltage.....	4.1	5.6	8.0	6.3 Volts
Heater Current.....	600	450	300	410 Ma
Maximum Heater-Cathode Voltage				
Heater Positive with Respect to Cathode				
Total DC and Peak.....				110 Volts
Heater Positive with Respect to Cathode				
Total DC and Peak.....				110 Volts

**DIRECT INTERELECTRODE CAPACITANCES**

**Triode Section**

Plate to Grid .....	1.8 Pf
Grid to Cathode and Heater .....	3.3 Pf
Plate to All Except Grid .....	1.7 Pf

**Pentode Section (Shielded)**

Input .....	6.2 Pf
Output .....	3.5 Pf
Plate to Grid No. 1 .....	0.009 Pf
Grid No. 1 to Grid No. 2 .....	1.5 Pf
<b>Coupling</b>	
Triode Plate to Pentode Plate (Max.) .....	0.025 Pf
Pentode Plate to Triode Grid (Max.) .....	0.01 Pf
Triode Plate to Pentode Grid No. 1 (Max.) .....	0.01 Pf
Triode Grid to Pentode Grid No. 1 (Max.) .....	0.01 Pf

**RATINGS (Design Maximum Rating System)**

	Triode Section	Pentode Section
Plate Supply Voltage (Max.) .....	600	600 Volts
Plate Voltage (Max.) .....	140	275 Volts
Grid No. 2 Supply Voltage (Max.) .....	—	600 Volts
Grid No. 2 Voltage (Max.) .....	—	275 Volts
Grid No. 1 Voltage (Max.) .....	—	-50 Volts



Cathode Current (Max.)	22	20 Ma
Plate Dissipation (Max.)	1.8	2.4 Watts
Grid No. 2 Dissipation (Max.)	—	0.55 Watts
Grid No. 1 Circuit Resistance		
Fixed Bias (Max.)	0.5	2.2 Megohms
Cathode Bias (Max.)	0.5	1 Megohm

**CHARACTERISTICS AND TYPICAL OPERATION**

**Triode as Oscillator**

DC Plate Supply Voltage	200	200 Volts
Plate Load Resistance	8200	12,000 Ohms
External Grid to Cathode Resistance	10,000	10,000 Ohms
Plate Current	16	12 Ma
Oscillator Voltage (Effective)	4.5	3.3 Volts
Transconductance (Effective)	3700	3700 $\mu$ mhos

**Pentode Section as Mixer**

Plate Supply Voltage	200	200 Volts
Plate Load Resistance	2700	4700 Ohms
DC Grid No. 2 Supply Voltage	200	200 Volts
Grid No. 2 Resistance	27,000	27,000 Ohms
DC Grid No. 1 Supply Voltage	-1.2	0 Volts
Grid No. 1 Resistance	0.1	1 Megohm
Oscillator Voltage (Effective)	1.6	1.6 Volts
Plate Current	10	9 Ma
DC Grid No. 2 Current	3	2.8 $\mu$ a
DC Grid No. 1 Current	10	2.3 $\mu$ a
Conversion Transconductance	5000	4700 $\mu$ mhos
Input Resistance at 200 Hz	600	600 Ohms

**Pentode Section as an If Amplifier**

Plate Supply Voltage	200	200 Volts
Plate Load Resistance	2700	4700 Ohms
Grid No. 2 Resistance	27,000	27,000 Ohms
Grid No. 1 Resistance	0.1	1 Megohm
DC Grid No. 1 Supply Voltage	-1.2	0 Volts
Plate Current	10	12.5 Ma
DC Grid No. 2 Current	3	3.7 Ma
Transconductance	11,000	14,000 $\mu$ mhos
DC Grid No. 1 Voltage for $G_m/100$	-12	-15 Volts
Input Resistance at 50 Hz	10,000	10,000 Ohms
DC Grid No. 2 Supply Voltage	200	200 Volts

Color Television Type  
**VHF AMPLIFIER**

**6GK5/6FQ5A**

2GK5/2FQ5A, 3FQ5A,  
3GK5, 4GK5

**Gain Controlled Triode**

Construction	Miniature T-5½
Base	Button 7 Pin, E7-1
Basing	7FP
Outline	5-2
Maximum Diameter	0.750 In.
Maximum Seated Height	1.875 In.
Maximum Overall Height	2.125 In.

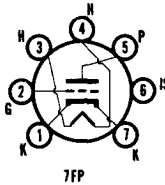

**ELECTRICAL DATA**

**HEATER OPERATION**

	2GK5/2FQ5A	3FQ5A 3GK5	4GK5	6GK5/6FQ5A
Heater Voltage	2.3	2.8	4.0	6.3 Volts
Heater Current	600	450	300	180 Ma
Heater Warm-up Time	11	11	11	— Seconds
Maximum Heater-Cathode Voltage				
Heater Negative with Respect to Cathode				
Total DC and Peak				100 Volts
Heater Positive with Respect to Cathode				
Total DC and Peak				100 Volts

**DIRECT INTERELECTRODE CAPACITANCES (Shielded)**

Grid to Plate	0.52 Pf
Input: g to (h + k + IS + ES)	5.0 Pf
Output: p to (h + k + IS + ES)	3.5 Pf
Heater to Cathode	2.5 Pf

**RATINGS (Design Maximum Rating System)**

Plate Voltage (Max.) .....	200 Volts
Plate Dissipation (Max.) .....	2.5 Watts
DC Cathode Current (Max.) .....	22 Ma
Negative Grid Voltage (Max.) .....	50 Volts
Grid Circuit Resistance (Self Bias) (Max.) .....	1.0 Megohm

**CHARACTERISTICS AND TYPICAL OPERATION**

**Class A1 Amplifier**

Plate Voltage .....	135 Volts
Grid Voltage .....	-1.0 Volts
Plate Current .....	11.5 Ma
Transconductance .....	15,000 $\mu$ mhos
Amplification Factor .....	78
Plate Resistance (Approx.) .....	5400 Ohms
$E_c$ for $G_m = 150 \mu$ mhos (Approx.) .....	-4.2 Volts
$E_c$ for $G_m = 1500 \mu$ mhos (Approx.) .....	-2.5 Volts
Input Resistance (200 Hz) <sup>(1)</sup> .....	275 Ohms
Input Capacitance (200 Hz) <sup>(1)</sup> .....	11.2 Pf
Noise Figure (200 Hz) <sup>(2)</sup> .....	4.7 db

**NOTES:**

- (1) Measured under grounded plate conditions.
- (2) Optimized neutralized triode RF amplifier stage, noise matched.

**AVERAGE PLATE CHARACTERISTICS**

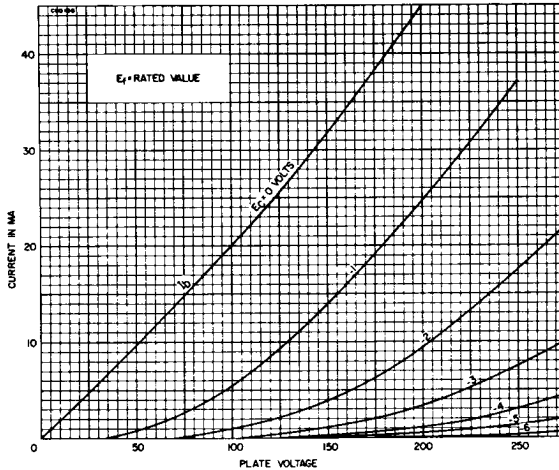

# 6GK6

10GK6, 16GK6

Color Television Type

## AUDIO POWER AMPLIFIER or VIDEO AMPLIFIER

**Beam Power Pentode**

Construction .....	Miniature T-6½
Base .....	Button 9 Pin, E9-1
Basing .....	.9GK
Outline .....	6-4
Maximum Diameter .....	0.875 In.
Maximum Seated Height .....	2.812 In.
Maximum Overall Height .....	3.062 In.

**ELECTRICAL DATA  
HEATER OPERATION**

Heater Voltage .....	16.0	10.0	6.3 Volts
Heater Current .....	300	450	760 Ma
Heater Warm-up Time .....	11	11	— Seconds

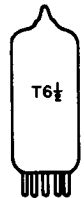
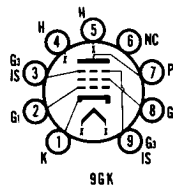

<b>16GK6</b>	<b>10GK6</b>
16.0	10.0
300	450
11	11

<b>6GK6</b>
6.3 Volts
760 Ma
— Seconds

Maximum Heater-Cathode Voltage	
Heater Negative with Respect to Cathode	
Total DC and Peak.....	100 Volts
Heater Positive with Respect to Cathode	
Total DC and Peak.....	100 Volts

**DIRECT INTERELECTRODE CAPACITANCES**

Grid No. 1 to Plate (Max.).....	0.14 Pf
Input .....	10 Pf
Output .....	7 Pf

**RATINGS (Design Maximum Rating System)**

Plate Voltage (Max.) <sup>(1)</sup> .....	330 Volts
Grid No. 2 Voltage (Max.) <sup>(1)</sup> .....	330 Volts
Negative Grid No. 1 Voltage (Max.) .....	100 Volts
Plate Dissipation (Max.) .....	13.2 Watts
Grid No. 2 Dissipation (Average) (Max.) .....	2 Watts
Grid No. 2 Dissipation (Peak) (Max.) .....	4 Watts
Cathode Current (Max.) .....	65 Ma
Grid No. 1 Circuit Resistance	
Fixed Bias (Max.) .....	0.3 Megohm
Cathode Bias (Max.) .....	1.0 Megohm

**CHARACTERISTICS AND TYPICAL OPERATION**

	Pentode Section	
	Single Tube Class A1	Class AB1 Push-Pull
Plate Voltage .....	250	250 300 Volts
Grid No. 2 Voltage .....	250	250 300 Volts
Grid No. 1 Voltage .....	-7.3	— Volts
Cathode Resistor .....	135	130 130 Ohms
Grid Voltage (RMS) Per Grid.....	4.3	8 10 Volts
Plate Current (Zero Signal) .....	48	62 72 Ma
Plate Current (Max. Signal) .....	49.5	75 92 Ma
Grid No. 2 Current (Zero Signal) .....	5.5	7.0 8 Ma
Grid No. 2 Current (Max. Signal).....	10.8	15 22 Ma
Transconductance .....	11.3K	— $\mu$ mhos
Amplification Factor <sup>(2)</sup> .....	19	— —
Plate Resistance.....	38K	— Ohms
Load Resistance .....	5.2K	— Ohms
Load Resistance (Plate to Plate).....	—	8K 8K Ohms
Maximum Signal Power Output .....	5.7	11 17 Watts
Total Harmonic Distortion .....	10	3.0 4.0 Percent

**NOTES:**

- (1) When the heater and positive voltages are obtained from a storage battery by means of a vibrator, the maximum values of the plate and Grid No. 2 voltages are 275 volts and that of the plate dissipation 9.9 watts.
- (2) Measured from Grid No. 2 to Plate.

**AVERAGE PLATE CHARACTERISTICS**

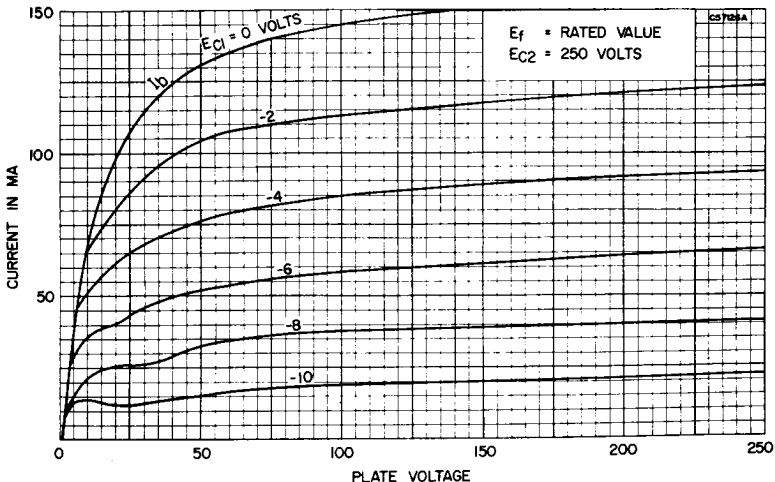

# 6GL7

## Color Television Type VERTICAL DEFLECTION OSCILLATOR and AMPLIFIER

**Double Dissimilar Triode**

Construction .....Octal T-9  
 Base .....8 Pin, B8-6  
 Basing .....8BD  
 Outline .....9-5  
   Maximum Diameter .....1.188 In.  
   Maximum Seated Height .....2.438 In.  
   Maximum Overall Height .....3.000 In.

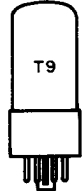
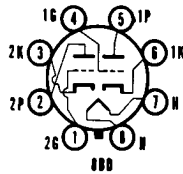

**ELECTRICAL DATA**

**HEATER OPERATION**

Heater Voltage.....	6.3 Volts
Heater Current .....	1050 Ma
Maximum Heater-Cathode Voltage	
Heater Negative with Respect to Cathode	
Total DC and Peak.....	200 Volts
Heater Positive with Respect to Cathode	
DC .....	100 Volts
Total DC and Peak.....	200 Volts

**DIRECT INTERELECTRODE CAPACITANCES (Unshielded)**

	Section No. 1	Section No. 2
Grid to Plate .....	4.0	8.0 Pf
Input .....	2.2	6.0 Pf
Output .....	0.6	1.3 Pf

**RATINGS (Design Maximum Rating System)**

**Vertical Deflection Oscillator and Amplifier<sup>(1,2)</sup>**

	Oscillator	Amplifier
Plate Voltage (Max.) .....	350	550 Volts
Peak Positive Pulse Plate Voltage (Abs. Max.) .....	—	1500 Volts
Plate Dissipation (Each Plate) (Max.) <sup>(3)</sup> .....	1.0	10 Watts
Total Plate Dissipation (Both Plates) (Max.) .....	12	12 Watts
Peak Negative Pulse Grid Voltage (Max.) .....	400	250 Volts
Average Cathode Current (Max.).....	—	50 Ma
Peak Cathode Current (Max.).....	—	175 Ma
Grid Circuit Resistance		
Fixed Bias (Max.) .....	1.0	1.0 Megohm
Cathode Bias (Max.) .....	2.2	2.2 Megohms

**CHARACTERISTICS AND TYPICAL OPERATION**

	Oscillator		Amplifier
Plate Voltage .....	250	275	175 Volts
Grid Voltage .....	-3.0	—	-25 Volts
Plate Current .....	2.0	13	46 Ma
Transconductance .....	2200	1600	6400 $\mu$ mhos
Amplification Factor .....	66	—	5
Plate Resistance (Approx.) .....	30,000	—	780 Ohms
Grid Voltage for Ib = 20 $\mu$ a.....	5.3	—	— Ma
Grid Voltage for Ib = 200 $\mu$ a.....	—	—	-60 Volts

**INSTANTANEOUS PLATE KNEE CHARACTERISTICS (Section No. 2)**

Eb = 60 V, and Ec1 = 0 V  
 Ib = 100 Ma

**NOTES:**

- (1) For operation in a 525 line, 30 frame system as described in "Standards of Good Engineering Practice for Television Broadcast Stations; Federal Communications Commission," the duty cycle of the voltage pulse must not exceed 15% of one horizontal scanning cycle.
- (2) Section No. 1 is recommended for vertical oscillator service, and Section No. 2 is recommended for vertical deflection amplifier service.
- (3) In stages operating with grid leak bias, an adequate bias resistor or other suitable means is required to protect the tube in the absence of excitation.

# AUDIO POWER AMPLIFIER

# 6GM5

**Beam Power Pentode**

Construction .....9-T9  
 Base .....Button 9 Pin, E9-68  
 Basing .....9MQ  
 Outline .....9-71  
 Maximum Diameter .....1.188 In.  
 Maximum Seated Height .....2.920 In.  
 Maximum Overall Height .....3.230 In.

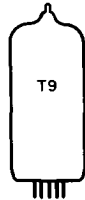
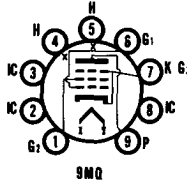

**ELECTRICAL DATA**

**HEATER OPERATION**

Heater Voltage..... 6.3 Volts  
 Heater Current ..... 800 Ma  
 Maximum Heater-Cathode Voltage  
 Heater Negative with Respect to Cathode  
 Total DC and Peak..... 200 Volts  
 Heater Positive with Respect to Cathode  
 DC ..... 100 Volts  
 Total DC and Peak..... 200 Volts

**DIRECT INTERELECTRODE CAPACITANCES (Unshielded)**

Grid No. 1 to Plate ..... 0.13 Pf  
 Input ..... 9.0 Pf  
 Output ..... 4.0 Pf

**RATINGS (Design Maximum Rating System)**

Plate Voltage (Max.) ..... 550 Volts  
 Grid No. 2 Voltage (Max.) ..... 440 Volts  
 Plate Dissipation (Max.) ..... 19 Watts  
 Grid No. 2 Dissipation (Max.)<sup>(1)</sup> ..... 3.3 Watts  
 Cathode Current (Max.) ..... 85 Ma  
 Grid No. 1 Circuit Resistance  
 Fixed Bias (Max.) ..... 0.3 Megohm  
 Self Bias (Max.) ..... 1.0 Megohm

**CHARACTERISTICS AND TYPICAL OPERATION**

	Pentode Operation		Ultra-Linear Operation <sup>(2)</sup>	
	S.T.—Class A1 Amp.		Class AB1—Push-Pull	
Plate Voltage	300	400	400	425 Volts
Grid No. 2 Voltage	300	Note 2	Note 2	Note 2 Volts
Grid No. 1 Voltage	-10	-20.5	-20.5	— Volts
Cathode Resistor	—	—	—	185 Ohms
Peak A-F Grid Voltage	10	41	41	42 Volts
Zero-Signal Plate Current	60	80	80	88 Ma
Maximum-Signal Plate Current	75	138	138	104 Ma
Zero-Signal Grid No. 2 Current	8	11.5	11.5	13 Ma
Maximum Signal Grid No. 2 Current	15	26.4	26.4	17.5 Ma
Transconductance	10.2K	—	—	— $\mu$ mhos
Plate Resistance (Approx.)	29K	—	—	— Ohms
Load Resistance	3K	—	—	— Ohms
Load Resistance (PL to PL)	—	6600	6600	6600 Ohms
Power Output	11	32	32	26 Watts
Total Harmonic Distortion	13	1.0	1.0	2 Percent

**Pentode Operation (Class AB1 Push-Pull Amp)**

Plate Voltage	300	350	400	450	450	450 Volts
Grid No. 2 Voltage	300	350	350	350	400	400 Volts
Grid No. 1 Voltage	-12.5	-15.5	-16	-16.5	-21	— Volts
Cathode Resistor	—	—	—	—	—	200 Ohms
Peak A-F Grid Voltage	25	31	32	33	42	28 Volts
Zero-Signal Plate Current	86	92	85	77	66	82 Ma
Maximum-Signal Plate Current	116	130	143	153	144	94 Ma
Zero-Signal Grid No. 2 Current	12.6	13	11	9.6	9.4	11.5 Ma
Maximum-Signal Grid No. 2 Current	26	28.6	27	27	30	22 Ma
Load Resistance (PL to PL)	6600	6600	6600	6600	6600	9000 Ohms
Power Output	23	30	37	43	45	28 Watts
Total Harmonic Distortion	2.5	2	1.5	1.5	1.5	2 Percent

**NOTES:**

- (1) Grid No. 2 dissipation may be permitted to reach 6 watts during the periods of maximum input of speech and music signals.
- (2) Grid No. 2 tapped at 40% of the primary winding.

# 6GM6

4GM6, 5GM6

## Color Television Type IF AMPLIFIER

### Semi-Remote Cutoff Pentode

Construction ..... Miniature T-5½  
 Base ..... Button 7 Pin, E7-1  
 Basing ..... 7CM  
 Outline ..... 5-2  
 Maximum Diameter ..... 0.750 In.  
 Maximum Seated Height ..... 1.875 In.  
 Maximum Overall Height ..... 2.125 In.

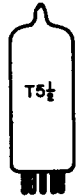
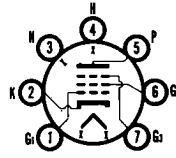

### ELECTRICAL DATA HEATER OPERATION

	4GM6	5GM6	6GM6
Heater Voltage.....	4.2	5.6	6.3 Volts
Heater Current.....	600	450	400 Ma
Heater Warm-up Time.....	11	11	— Seconds
Maximum Heater-Cathode Voltage			
Heater Negative with Respect to Cathode			
Total DC and Peak.....			200 Volts
Heater Positive with Respect to Cathode			
DC.....			100 Volts
Total DC and Peak.....			200 Volts

### DIRECT INTERELECTRODE CAPACITANCES (Unshielded)

Grid No. 1 to Plate (Max.).....	0.036 Pf
Input: g1 to (h + k + g2 + g3 + IS).....	10.0 Pf
Output: p to (h + k + g2 + g3 + IS).....	2.4 Pf

### RATINGS (Design Maximum Rating System)

Plate Voltage (Max.).....	330 Volts
Grid No. 2 Supply Voltage (Max.).....	330 Volts
Grid No. 2 Voltage.....	See Rating Chart (Gen. Info. Sec.)
Positive Grid No. 1 Voltage (Max.).....	0 Volt
Plate Dissipation (Max.).....	3.1 Watts
Grid No. 2 Input (Max.).....	0.65 Watts

### AVERAGE PLATE CHARACTERISTICS

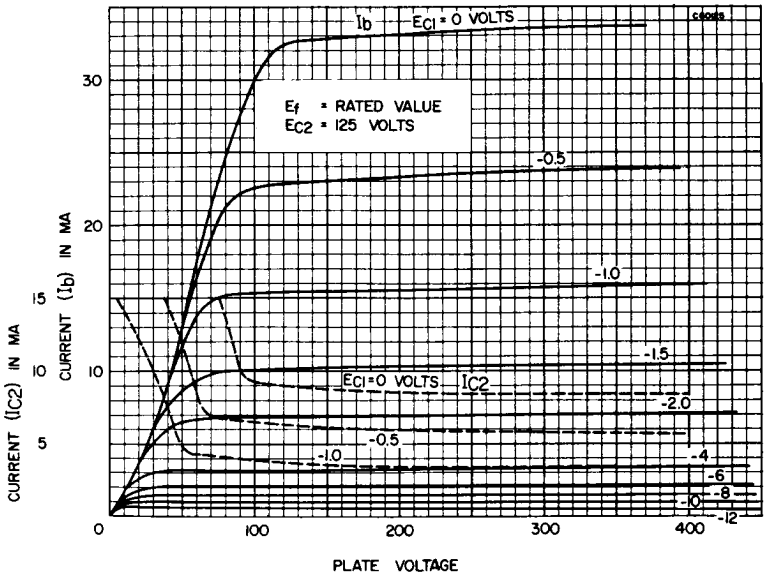

**AVERAGE TRANSFER CHARACTERISTICS**

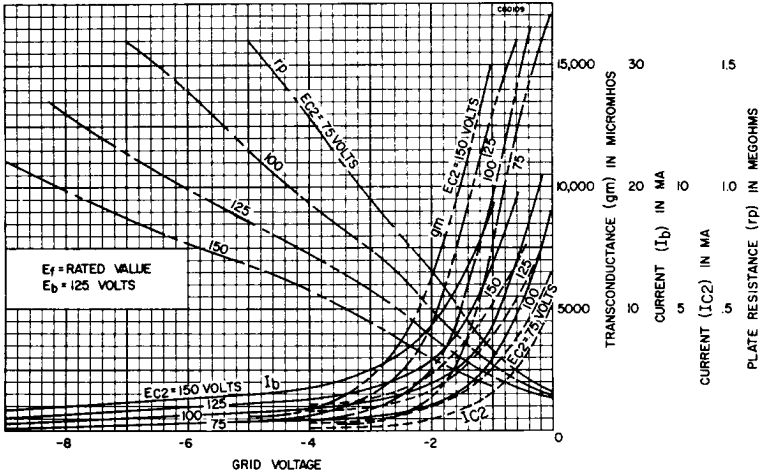

**CHARACTERISTICS AND TYPICAL OPERATION**

**Class A1 Amplifier**

Plate Voltage .....	125 Volts
Grid No. 3 .....	Tied to Cathode
Grid No. 2 Voltage .....	125 Volts
Cathode Bias Resistor .....	56 Ohms
Plate Current .....	14 Ma
Grid No. 2 Current .....	3.4 Ma
Transconductance .....	13,000 $\mu$ mhos
Plate Resistance (Approx.) .....	0.2 Megohm
Ec1 for Gm = 60 $\mu$ mhos (Approx.) .....	-15 Volts

**SYNC SEP. or VOLTAGE AMP. (T)  
VIDEO AMPLIFIER (P)**

**6GN8**  
8GN8, 10GN8

**High Mu Triode and Sharp Cutoff Pentode**

Construction .....	Miniature T-6½
Base .....	Button 9 Pin, E9-1
Basing .....	.9DX
Outline .....	6-3
Maximum Diameter .....	0.875 In.
Maximum Seated Height .....	2.375 In.
Maximum Overall Height .....	2.625 In.

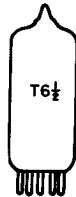
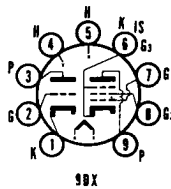

**ELECTRICAL DATA  
HEATER OPERATION**

	10GN8	8GN8	6GN8
Heater Voltage.....	10.5	8.0	6.3 Volts
Heater Current .....	450	600	750 Ma
Heater Warm-up Time .....	11	11	— Seconds
Maximum Heater-Cathode Voltage			
Heater Negative with Respect to Cathode			
Total DC and Peak .....			200 Volts
Heater Positive with Respect to Cathode			
DC .....			100 Volts
Total DC and Peak .....			200 Volts

**DIRECT INTERELECTRODE CAPACITANCES (Unshielded)**

**Triode Section**

Grid to Plate .....	4.4 Pf
Input: g to (h + k) .....	2.4 Pf
Output: p to (h + k) .....	0.36 Pf

**Pentode Section**

Grid No. 1 to Plate (Max.).....	0.1 Pf
Input: g1 to (h + k + g2 + g3 + IS).....	11 Pf
Output: p to (h + k + g2 + g3 + IS).....	4.2 Pf

**Coupling**

Triode Grid to Pentode Plate (Max.) .....	0.018 Pf
Pentode Grid No. 1 to Triode Plate (Max.) .....	0.005 Pf
Pentode Plate to Triode Plate (Max.) .....	0.17 Pf

**RATINGS (Design Maximum Rating System)**

	<b>Triode Section</b>	<b>Pentode Section</b>
Plate Voltage (Max.) .....	330	330 Volts
Grid No. 2 Supply Voltage (Max.) .....	—	330 Volts
Grid No. 2 Voltage (Max.).....	See Rating Chart (Gen. Info. Sec.)	
Positive Grid No. 1 Voltage (Max.) .....	0	0 Volt
Plate Dissipation (Max.) .....	1.0	5.0 Watts
Grid No. 2 Dissipation .....	—	1.1 Watts
Grid No. 1 Circuit Resistance		
Fixed Bias (Max.) .....	0.5	0.25 Megohm
Cathode Bias (Max.) .....	1.0	1.0 Megohm

**CHARACTERISTICS AND TYPICAL OPERATION**

	<b>Triode Section</b>	<b>Pentode Section</b>
Plate Voltage .....	250	200 Volts
Grid No. 2 Voltage .....	—	150 Volts
Grid No. 1 Voltage .....	-2	— Volts
Cathode Bias Resistor .....	—	100 Ohms
Plate Current .....	2	25 Ma
Grid No. 2 Current .....	—	5.5 Ma
Transconductance .....	2700	11,500 $\mu$ mhos
Amplification Factor .....	100	—
Plate Resistance .....	37,000	60,000 Ohms
E <sub>c1</sub> for I <sub>b</sub> = 100 $\mu$ a (Approx.).....	—	-10 Volts
E <sub>c1</sub> for I <sub>b</sub> = 200 $\mu$ a (Approx.).....	-5	— Volts

**INSTANTANEOUS PLATE KNEE CHARACTERISTICS (Pentode Section)**

E<sub>b</sub> = 60 Volts, E<sub>c2</sub> = 150 Volts and E<sub>c1</sub> = 0 Volts  
 I<sub>b</sub> = 55 Ma and I<sub>c2</sub> = 18 Ma.



**Triode Diode**

Construction .....	Miniature T-6½
Base .....	Button 9 Pin, E9-1
Basing .....	.9QM
Outline .....	6-2
Maximum Diameter .....	0.875 In.
Maximum Seated Height .....	1.937 In.
Maximum Overall Height .....	2.187 In.

**ELECTRICAL DATA  
 HEATER OPERATION**

	<b>19GQ7</b>	<b>6GQ7</b>
Heater Voltage.....	18.9	6.3 Volts
Heater Current .....	150	450 Ma
Maximum Heater-Cathode Voltage		
Heater Negative with Respect to Cathode		
Total DC and Peak.....		200 Volts
Heater Positive with Respect to Cathode		
DC .....		100 Volts
Total DC and Peak.....		200 Volts

**DIRECT INTERELECTRODE CAPACITANCES (Unshielded)**

Plate Input: p to (k + h) (Each Section) .....	2.05 Pf
Cathode Input: k to (p + h) (Each Section) .....	3.10 Pf
1p to 2p .....	0.47 Pf
1p to 3p .....	0.47 Pf
2p to 3p .....	0.05 Pf

**RATINGS (Design Maximum Rating System) (Each Section)**

Peak Inverse Plate Voltage (Max.) .....	330 Volts
AC Plate Voltage (RMS) (Max.) .....	117 Volts
Peak Plate Current (Max.) .....	54 Ma
DC Output Current (Max.) .....	9 Ma
Total Effective Supply Impedance (Min.) .....	300 Ohms

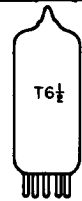
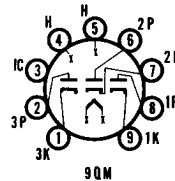



**CHARACTERISTICS AND TYPICAL OPERATION (Each Section)**

Half Wave Rectifier

Diode Current at Eb = 10 Volts DC.....

60 Ma

Color Television Type

**SYNC SEPARATOR/CLIPPER  
and AGC TUBE**

**6GS8**

6BU8, 3GS8/3BU8,  
4GS8/4BU8

**Double Pentode**

Construction ..... Miniature T-6½  
Base ..... Button 9 Pin, E9-1  
Basing(1) ..... 9LW or 9FG  
Outline ..... 6-3  
Maximum Diameter ..... 0.875 In.  
Maximum Seated Height ..... 2.375 In.  
Maximum Overall Height ..... 2.625 In.

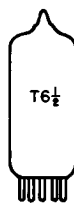
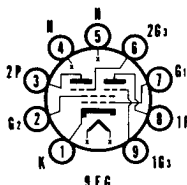

**ELECTRICAL DATA**

**HEATER OPERATION**

	3GS8/3BU8	4GS8/4BU8	6BU8 6GS8
Heater Voltage.....	3.15	4.2	6.3 Volts
Heater Current.....	600	450	300 Ma
Heater Warm-up Time.....	11	11	— Seconds
Maximum Heater-Cathode Voltage Heater Negative with Respect to Cathode Total DC and Peak.....			200 Volts
Heater Positive with Respect to Cathode DC.....			100 Volts
Total DC and Peak.....			200 Volts

**DIRECT INTERELECTRODE CAPACITANCES (Unshielded)**

Grid No. 3 to Plate (Each Section).....	1.9 Pf
Grid No. 1 to All.....	6.0 Pf
Grid No. 3 (Each Section) to All.....	3.6 Pf
Plate (Each Section) to All.....	3.0 Pf
Grid No. 3 (Section 1) to Grid No. 3 (Section 2) (Max.).....	0.015 Pf

**RATINGS (Design Maximum Rating System)**

Plate Voltage (Each Section) (Max.).....	300 Volts
Grid No. 2 Voltage (Max.).....	150 Volts
Positive DC Grid No. 3 Voltage (Each Section) (Max.).....	3.0 Volts
Negative DC Grid No. 3 Voltage (Each Section) (Max.).....	50 Volts
Peak Positive Grid No. 3 Voltage (Each Section) (Max.).....	50 Volts
Negative DC Grid No. 1 Voltage (Max.).....	50 Volts
Plate Dissipation (Each Section) (Max.).....	1.1 Watts
Grid No. 2 Dissipation (Max.).....	0.75 Watt
DC Cathode Current (Max.).....	12 Ma
Grid No. 1 Circuit Resistance (Max.).....	0.5 Megohm
Grid No. 3 Circuit Resistance (Each Section) (Max.).....	0.5 Megohm

**CHARACTERISTICS AND TYPICAL OPERATION**

**Both Sections Operating**

Plate Voltage (Each Section).....	100	100 Volts
Grid No. 2 Voltage.....	67.5	67.5 Volts
Grid No. 3 Voltage (Each Section).....	-10	0 Volts
Grid No. 1 Voltage.....	Note 2	Note 2
Plate Current (Each Section).....	—	2.2 Ma
Grid No. 2 Current.....	6.5	3.3 Ma
Cathode Current.....	6.6	7.8 Ma

**Each Section Separately with Plate and Grid No. 3  
of Opposite Section Grounded**

Plate Voltage.....	100	100 Volts
Grid No. 2 Voltage.....	67.5	67.5 Volts
Grid No. 3 Voltage.....	0	0 Volt
Grid No. 1 Voltage.....	0	Note 2
Plate Current.....	—	2.2 Ma
Grid No. 3 Transconductance.....	—	180 μmhos
Grid No. 1 Transconductance.....	1500	11 μmhos
Grid No. 3 Voltage (Approx.) for Ib = 100 μa.....	—	-4.5 Volts
Grid No. 1 Voltage (Approx.) for Ib = 100 μa.....	—	-2.3 Volts

**NOTES:**

- (1) Basing 9LW has Internal Shield tied to Cathode.  
Basing 9FG has Internal Shield tied to Grid No. 2.
- (2) Grid Current adjusted for 100 μa DC.

**6GT5**

12GT5, 17GT5

**HORIZONTAL DEFLECTION  
AMPLIFIER****Beam Power Pentode**

Construction .....Novar T-12  
 Base .....Novar Button 9 Pin, E9-76  
 Basing .....9NZ  
 Outline .....12-64  
 Maximum Diameter .....1.562 In.  
 Maximum Seated Height .....3.050 In.  
 Maximum Overall Height .....3.410 In.

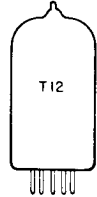
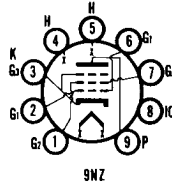
**ELECTRICAL DATA****HEATER OPERATION**

	17GT5	12GT5	6GT5
Heater Voltage.....	16.8	12.6	6.3 Volts
Heater Current.....	450	600	1200 Ma
Heater Warm-up Time.....	11	11	— Seconds
Maximum Heater-Cathode Voltage			
Heater Negative with Respect to Cathode			
Total DC and Peak.....			200 Volts
Heater Positive with Respect to Cathode			
DC.....			100 Volts
Total DC and Peak.....			200 Volts

**DIRECT INTERELECTRODE CAPACITANCES (Unshielded)**

Grid to Plate.....	0.26 Pf
Input: $g_1$ to $(h + k + g_2 + g_3)$ .....	15 Pf
Output: $p$ to $(h + k + g_2 + g_3)$ .....	6.5 Pf

**RATINGS (Design Maximum Rating System)****Horizontal Deflection Amplifier<sup>(1)</sup>**

DC Plate Supply Voltage (Boost + DC Power Supply) (Max.).....	770 Volts
Peak Positive Plate Voltage (Max.).....	6500 Volts
Peak Negative Plate Voltage (Max.).....	1500 Volts
Grid No. 2 Voltage (Max.).....	220 Volts
Negative Grid No. 1 Voltage (Max.).....	-55 Volts
Peak Negative Grid No. 1 Voltage (Max.).....	330 Volts
Plate Dissipation (Max.) <sup>(2)</sup> .....	17.5 Watts
Grid No. 2 Input (Max.).....	3.5 Watts
Average Cathode Current (Max.).....	175 Ma
Peak Cathode Current (Max.).....	550 Ma
Grid No. 1 Circuit Resistance (Max.).....	1.0 Megohm
Bulb Temperature (At Hottest Point) (Max.).....	240 °C

**CHARACTERISTICS AND TYPICAL OPERATION**

Plate Voltage.....	250 Volts
Grid No. 2 Voltage.....	150 Volts
Grid No. 1 Voltage.....	-22.5 Volts
Plate Current.....	70 Ma
Grid No. 2 Current.....	2.1 Ma
Transconductance.....	7100 $\mu$ mhos
Amplification Factor <sup>(3)</sup> .....	4.4
Plate Resistance.....	15,000 Ohms
$E_{c1}$ for $I_b = 1$ Ma (Approx.).....	-42 Volts

**INSTANTANEOUS PLATE KNEE VALUES**

$E_b = 60$  V,  $E_{c2} = 150$  V, and  $E_{c1} = 0$  V;

$I_b = 390$  Ma; and  $I_{c2} = 32$  Ma

**NOTES:**

- (1) For operation in a 525 line, 30 frame system as described in "Standards of Good Engineering Practice for Television Broadcast Stations; Federal Communications Commission," the duty cycle of the voltage pulse must not exceed 15% of one horizontal scanning cycle.
- (2) In stages operating with grid leak bias, an adequate cathode bias resistor or other suitable means is required to protect the tube in the absence of excitation.
- (3) Amplification factor with tube operation as a triode with 150 volts on the plate and Grid No. 2 and -22.5 volts on Grid No. 1.

## HORIZONTAL DEFLECTION AMPLIFIER

# 6GT5A

12GT5A, 17GT5A

### Beam Power Pentode

Construction ..... Novar T-12  
 Base ..... Novar Button 9 Pin, E9-88  
 (Exhaust Tip on Base)

Basing ..... 9NZ  
 Outline ..... 12-95  
 Maximum Diameter ..... 1.562 In.  
 Maximum Seated Height ..... 2.500 In.  
 Maximum Overall Height ..... 2.880 In.

The 6GT5A, 12GT5A, and 17GT5A are identical to the 6GT5, 12GT5, and 17GT5 except for base with exhaust tip at bottom and shorter bulb.

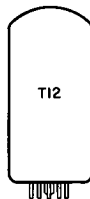
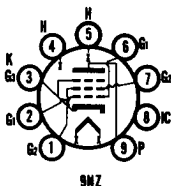

## VHF AMPLIFIER

# 6GU5

2GU5, 3GU5

### Shadow Grid Beam Pentode

Construction ..... Miniature T-5½  
 Base ..... Button 7 Pin, E7-1  
 Basing ..... 7GA

Outline ..... 5-2  
 Maximum Diameter ..... 0.750 In.  
 Maximum Seated Height ..... 1.875 In.  
 Maximum Overall Height ..... 2.125 In.

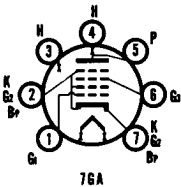

### ELECTRICAL DATA HEATER OPERATION

Heater Voltage .....	2.4	3.1	6.3 Volts
Heater Current .....	600	450	220 Ma
Heater Warm-up Time .....	11	11	— Seconds
Maximum Heater-Cathode Voltage			
Heater Negative with Respect to Cathode			200 Volts
Total DC and Peak .....			
Heater Positive with Respect to Cathode			100 Volts
DC .....			200 Volts
Total DC and Peak .....			

### DIRECT INTERELECTRODE CAPACITANCES (Unshielded)

Grid No. 1 to Plate .....	0.018 Pf
Input: g1 to (h + k + g2 + g3 + bp) .....	7.0 Pf
Output: p to (h + k + g2 + g3 + bp) .....	3.2 Pf

### RATINGS (Design Maximum Rating System)

Plate Voltage (Max.) .....	300 Volts
Screen Voltage (Max.) .....	150 Volts
Positive DC Grid No. 1 Voltage (Max.) .....	0 Volt
Negative DC Grid No. 1 Voltage (Max.) .....	50 Volts
Plate Dissipation (Max.) .....	3.0 Watts
Screen Dissipation (Max.) .....	0.15 Watt
DC Cathode Current (Max.) .....	20 Ma
Grid No. 1 Circuit Resistance	
With Fixed Bias (Max.) .....	0.5 Megohm

### CHARACTERISTICS AND TYPICAL OPERATION

Plate Voltage .....	135	275 Volts
Screen Voltage .....	135	135 Volts
Grid No. 1 Voltage .....	-0.4	-0.4 Volt
Plate Resistance (Approx.) .....	0.67	0.165 Megohm
Transconductance .....	15,000	15,500 μmhos
Plate Current .....	9.0	10 Ma
Screen Current .....	0.25	0.17 Ma
Noise Figure		
Measured at 200 Hz .....	5.9	5.7 Decibels
Grid No. 1 Voltage (Approx.)		
Gm = 100 μmhos .....	-6.2	-6.5 Volts

# 6GU7

8GU7

Color Television Type

## VERTICAL/HORIZONTAL OSC. or CHROMA AMPLIFIER

**Medium Mu Twin Triode**

Construction ..... Miniature T-6½  
 Base ..... Button 9 Pin, E9-1  
 Basing ..... 9LP  
 Outline ..... 6-3  
     Maximum Diameter ..... 0.875 In.  
     Maximum Seated Height ..... 2.375 In.  
     Maximum Overall Height ..... 2.625 In.

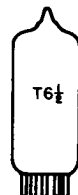
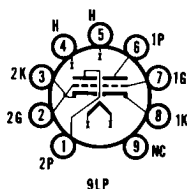

**ELECTRICAL DATA  
HEATER OPERATION**

	<b>8GU7</b>	<b>6GU7</b>
Heater Voltage.....	8.4	6.3 Volts
Heater Current .....	450	600 Ma
Heater Warm-up Time .....	11	11 Seconds
Maximum Heater-Cathode Voltage		
Heater Negative with Respect to Cathode		
Total DC and Peak.....		200 Volts
Heater Positive with Respect to Cathode		
DC .....		100 Volts
Total DC and Peak.....		200 Volts

**DIRECT INTERELECTRODE CAPACITANCES (Unshielded)**

	Section No. 1	Section No. 2
Grid to Plate .....	3.0	3.0 Pf
Input: g to (h + k) .....	3.4	3.6 Pf
Output: p to (h + k) .....	0.44	0.34 Pf
Plate of Section No. 1 to Plate of Section No. 2 .....	1.0	Pf

**RATINGS (Design Maximum Rating System)**

DC Plate Voltage (Max.) <sup>(1)</sup> .....	330 Volts
Positive Grid Voltage (Max.) .....	0 Volt
Plate Dissipation (Max.) <sup>(2)</sup> .....	3 Watts
Grid Circuit Resistance	
Fixed Bias (Max.) .....	1.0 Megohm

**CHARACTERISTICS AND TYPICAL OPERATION**

Plate Voltage .....	250 Volts
Grid No. 1 Voltage .....	-10.5 Volts
Plate Current .....	11.5 Ma
Transconductance .....	3100 μmhos
Amplification Factor .....	17
Plate Resistance (Approx.) .....	5500 Ohms
Grid Voltage for Ib = 50 μa (Approx.) .....	-23 Volts
Plate Current at Ec = -14 Vdc.....	4 Ma

**NOTES:**

- (1) For operation in a 525 line, 30 frame system as described in "Standards of Good Engineering Practice for Television Broadcast Stations; Federal Communications Commission," the duty cycle of the voltage pulse must not exceed 15% of one horizontal scanning cycle.
- (2) In stages operating with grid leak bias, an adequate bias resistor or other suitable means is required to protect the tube in the absence of excitation.

# 6GV5

17GV5

## HORIZONTAL DEFLECTION AMPLIFIER

**Beam Power Pentode**

Construction..... Compactron T-12  
 Base ..... Button 12 Pin, E12-74  
 Top Cap ..... C1-3  
 Basing ..... 12DR  
 Outline ..... 12-79  
     Maximum Diameter ..... 1.563 In.  
     Maximum Seated Height ..... 3.250 In.  
     Maximum Overall Height ..... 3.625 In.

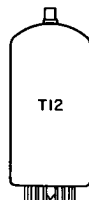
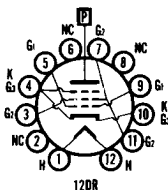

**ELECTRICAL DATA**

**HEATER OPERATION**

	<b>17GV5</b>	<b>6GV5</b>
Heater Voltage.....	16.8	6.3 Volts
Heater Current .....	450	1200 Ma
Heater Warm-up Time .....	11	— Seconds
Maximum Heater-Cathode Voltage		
Heater Negative with Respect to Cathode		
Total DC and Peak.....		200 Volts
Heater Positive with Respect to Cathode		
DC .....		100 Volts
Total DC and Peak.....		200 Volts

**DIRECT INTERELECTRODE CAPACITANCES (Unshielded)**

Grid No. 1 to Plate .....	0.6 Pf
Input .....	16 Pf
Output .....	7 Pf

**RATINGS (Design Maximum Rating System)**

**Horizontal Deflection Amplifier<sup>(1)</sup>**

DC Plate Supply Voltage (Boost + DC Power Supply) (Max.) .....	770 Volts
Peak Positive Pulse Plate Voltage .....	6500 Volts
Peak Negative Pulse Plate Voltage .....	1500 Volts
Plate Dissipation (Max.) <sup>(2)</sup> .....	17.5 Watts
Peak Negative Grid No. 1 Voltage (Max.) .....	330 Volts
Grid No. 2 Voltage (Max.) .....	220 Volts
Grid No. 2 Dissipation (Max.) .....	3.5 Watts
Average Cathode Current (Max.).....	175 Ma
Peak Cathode Current (Max.).....	550 Ma
Grid No. 1 Circuit Resistance (Max.) .....	1.0 Megohm
Bulb Temperature (At Hottest Point) (Max.) .....	220 °C

**CHARACTERISTICS AND TYPICAL OPERATION**

Plate Voltage .....	5000	250 Volts
Grid No. 2 Voltage .....	150	150 Volts
Grid No. 1 Voltage .....	—	-22.5 Volts
Plate Current .....	—	65 Ma
Grid No. 2 Current .....	—	1.8 Ma
Transconductance .....	—	7300 μmhos
Plate Resistance.....	—	18,000 Ohms
Amplification Factor <sup>(3)</sup> .....	—	4.4
Ec1 for Ib = 1.0 Ma (Approx.) .....	-100	-42 Volts

**INSTANTANEOUS PLATE KNEE VALUES**

Eb = 60 V; Ec2 = 150 V and Ec1 = 0  
Ib = 345 Ma, and Ic2 = 27 Ma

**NOTES:**

- (1) For operation in a 525 line, 30 frame system as described in "Standards of Good Engineering Practice for Television Broadcast Stations; Federal Communications Commission," the duty cycle of the voltage pulse must not exceed 15% of one horizontal scanning cycle.
- (2) In stages operating with grid leak bias, an adequate cathode bias resistor or other suitable means is required to protect the tube in the absence of excitation.
- (3) Amplification factor with tube operating as a triode with 150 volts on the plate and Grid No. 2 and -22.5 volts on Grid No. 1.

**VERTICAL DEFLECTION  
AMPLIFIER**

**6GV8**  
9GV8, 18GV8

**Triode and Pentode**

Construction .....Miniature T-6½  
Base .....Button 9 Pin, E9-1  
Basing .....9LY  
Outline

Maximum Diameter .....	0.875 In.
Maximum Seated Height .....	2.812 In.
Maximum Overall Height .....	3.062 In.

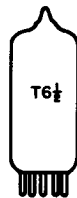
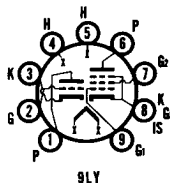

**ELECTRICAL DATA****HEATER OPERATION**

	<b>18GV8</b>	<b>9GV8</b>	<b>6GV8</b>
Heater Voltage.....	18	9.5	6.3 Volts
Heater Current .....	300	600	900 Ma
Maximum Heater-Cathode Voltage			
Heater Negative with Respect to Cathode .....			200 Volts
Heater Positive with Respect to Cathode .....			220 Volts

**RATINGS (Absolute Maximum Rating System)****Pentode Section**

Plate Voltage, Cut-off Condition (Max.) .....	550 Volts
Plate Voltage (Max.) .....	250 Volts
Peak Plate Voltage (Max.) <sup>(1)</sup> .....	2000 Volts
Plate Dissipation (Max.) .....	7 Watts
Screen Grid Voltage, Cut-off Condition (Max.) .....	550 Volts
Screen Grid Voltage (Max.) .....	250 Volts
Screen Grid Dissipation (Max.) .....	2 Watts
Cathode Current (Max.) .....	75 Ma
Series Grid Resistor (Fixed Bias) (Max.) .....	1 Megohm
Series Grid Resistor (Automatic Bias) (Max.) .....	2.2 Megohms
Heater-Cathode Resistance (Max.) .....	20,000 Ohms

**Triode Section**

Plate Supply Voltage (Max.) .....	550 Volts
Plate Voltage (Max.) .....	250 Volts
Plate Dissipation (Max.) .....	0.5 Watt
Cathode Current (Max.) .....	15 Ma
Peak Cathode Current (Max.) <sup>(2)</sup> .....	200 Ma
Series Grid Resistor (Fixed Bias) (Max.) .....	1 Megohm
Series Grid Resistor (Automatic Bias) (Max.) .....	3.3 Megohm
Heater-Cathode Resistance (Max.) .....	20,000 Ohms

**CHARACTERISTICS AND TYPICAL OPERATION****Pentode Section**

Plate Voltage .....	170 Volts
Screen Grid Voltage .....	170 Volts
Plate Current .....	41 Ma
Screen Grid Current .....	2.7 Ma
Negative Control Grid Voltage .....	15 Volts
Transconductance .....	7500 $\mu$ mhos
Amplification Factor—Grid No. 1 to Grid No. 2 .....	7
Internal Plate Resistance .....	25,000 Ohms

**Pentode Section****Knee Current of Average Tube**

Plate Voltage .....	50	65 Volts
Screen Grid Voltage .....	170	210 Volts
Plate Current .....	200	240 Ma
Screen Grid Current .....	40	50 Ma
Negative Control Grid Voltage .....	1	1 Volt

**Triode Section**

Plate Voltage .....	100 Volts
Plate Current .....	5 Ma
Negative Grid Voltage .....	0.8 Volt
Transconductance .....	6500 $\mu$ mhos
Amplification Factor .....	50
Internal Plate Resistance .....	7600 Ohms

**Pentode Section<sup>(3)</sup>**

Plate Voltage at End of the Scan (Min.).....	55 <sup>(4)</sup>	55 <sup>(4)</sup>	75 <sup>(5)</sup> Volts
Screen Grid Voltage .....	170	200	210 Volts
Negative Control Grid Voltage at End of the Scan <sup>(3)</sup> .....	6	9.5	11 Volts
Peak Plate Current .....	135	135	125 Ma
Nominal Screen Grid Dissipation .....	1.1	1.4	1.35 Watts

**NOTES:**

- (1) Maximum pulse duration 5% of a cycle with a maximum of 1 Msec.
- (2) Maximum pulse duration 200  $\mu$ sec. If a larger flyback is required Peak Cathode Current = 100 Ma with a maximum pulse duration of 400  $\mu$ sec.
- (3) If the vertical sweep circuit is designed so that full deflection is obtained at the nominal line voltage, and Eb minimum, Ec2 and Ib have their specified values, full deflection can still be obtained, with an end of life tube at the lower limit of the spread in characteristics, provided Ec1 at the end of the scan is -1V. This even holds for a line voltage that is 10% below its nominal value.
- (4) Non-stabilized circuits.
- (5) Stabilized circuits.
- (6) For an average tube.

**AF VOLTAGE AMPLIFIER and  
AUDIO POWER AMPLIFIER**

**6GW8/ECL86**

**Triode and Pentode**

Construction ..... Miniature T-6½  
 Base ..... Button 9 Pin, E9-1  
 Basing ..... 9LZ  
 Outline ..... 6-4  
 Maximum Diameter ..... 0.875 In.  
 Maximum Seated Height ..... 2.812 In.  
 Maximum Overall Height ..... 3.062 In.

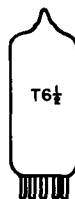
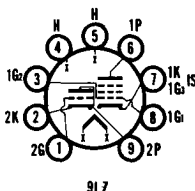

**ELECTRICAL DATA**

**HEATER OPERATION**

Heater Voltage ..... 6.3 Volts  
 Heater Current ..... 700 Ma  
 Maximum Heater-Cathode Voltage ..... 100 Volts

**DIRECT INTERELECTRODE CAPACITANCES**

**Pentode Section**

Control Grid to All Other Elements except Plate ..... 10 Pf  
 Plate to All Other Elements except Control Grid ..... 9.5 Pf  
 Plate to Control Grid (Max.) ..... 0.5 Pf  
 Control Grid to Heater (Max.) ..... 0.2 Pf

**Triode Section**

Grid to All Other Elements except Plate ..... 2 Pf  
 Plate to All Other Elements except Control Grid ..... 1.8 Pf  
 Plate to Grid ..... 1.6 Pf  
 Grid to Heater (Max.) ..... 0.04 Pf

**Coupling**

Plate of Triode to Control Grid of Pentode (Max.) ..... 0.2 Pf  
 Grid of Triode to Plate of Pentode (Max.) ..... 0.02 Pf  
 Grid of Triode to Control Grid of Pentode (Max.) ..... 0.02 Pf  
 Plate of Triode to Plate of Pentode (Max.) ..... 0.2 Pf

**RATINGS (Design Center Rating System)**

**Pentode Section**

Plate Voltage (Zero Plate Current) (Max.) ..... 550 Volts  
 Plate Voltage (Max.) ..... 300 Volts  
 Screen Grid Voltage (Zero Grid Current) (Max.) ..... 550 Volts  
 Screen Grid Voltage (Max.) ..... 300 Volts  
 Plate Dissipation (Max.) ..... 9 Watts  
 Screen Grid Dissipation (Max.) ..... 1.5 Watts  
 Peak Screen Grid Dissipation (Max.) ..... 3 Watts  
 Cathode Current (Max.) ..... 55 Ma  
 External Resistance Between Control Grid and Ground (Self Bias) (Max.) ..... 1 Megohm  
 Negative Control Grid Voltage (Control Grid Current = 0.3 µa) (Max.) ..... 1.3 Volts  
 Cathode-Heater Resistance (Max.) ..... 20,000 Ohms

**Triode Section**

Plate Voltage (Zero Plate Current) (Max.) ..... 550 Volts  
 Plate Voltage (Max.) ..... 300 Volts  
 Plate Dissipation (Max.) ..... 0.5 Watts  
 Cathode Current (Max.) ..... 8 Ma  
 External Resistance Between Grid and Ground (Self Bias) (Max.) ..... 2 Megohms  
 External Resistance Between Grid and Ground (Grid Leak Bias) (Max.) ..... 10 Megohms  
 Negative Grid Voltage (Grid Current = 0.3 µa) (Max.) ..... 1.3 Volts  
 Cathode-Heater Resistance (Max.) ..... 20,000 Ohms  
 Cathode-Heater Resistance (Max.) (In Phase Splitting Circuits) (Max.) ..... 120,000 Ohms

**CHARACTERISTICS AND TYPICAL OPERATION**

**Triode Section**

Plate Voltage ..... 250 Volts  
 Negative Grid Voltage ..... 1.7 Volts  
 Plate Current ..... 1.2 Ma  
 Transconductance ..... 1600 µmhos  
 Amplification Factor ..... 100

**Pentode Section**

Plate Voltage ..... 250 Volts  
 Screen Grid Voltage ..... 250 Volts  
 Negative Control Grid Voltage ..... 7 Volts  
 Plate Current ..... 36 Ma

Screen Grid Current .....	5.5 Ma
Transconductance .....	10,000 $\mu$ mhos
Internal Plate Resistance.....	45,000 Ohms
Amplification Factor—Grid No. 1 to Grid No. 2 .....	21

**6GX7**  
4GX7, 5GX7, 8GX7

Color Television Type  
**VHF OSCILLATOR and MIXER**

**Medium Mu Triode and Sharp Cutoff Pentode**

Construction ..... Miniature T-6½  
 Base ..... Button 9 Pin, E9-1  
 Basing ..... 9QA  
 Outline ..... 6-2  
 Maximum Diameter ..... 0.875 In.  
 Maximum Seated Height ..... 1.937 In.  
 Maximum Overall Height ..... 2.187 In.

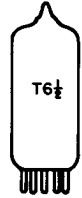
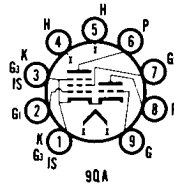

**ELECTRICAL DATA**

**HEATER OPERATION**

	4GX7	5GX7	8GX7	6GX7
Heater Voltage.....	4.2	5.6	7.7	6.3 Volts
Heater Current .....	600	450	300	400 Ma
Heater Warm-up Time .....	11	11	11	— Seconds
Maximum Heater-Cathode Voltage				
Heater Negative with Respect to Cathode				200 Volts
Total DC and Peak.....				100 Volts
Heater Positive with Respect to Cathode				200 Volts
DC .....				200 Volts
Total DC and Peak.....				

**DIRECT INTERELECTRODE CAPACITANCES (Shielded)<sup>(1)</sup>**

**Triode Section**

Grid to Plate .....	1.2 Pf
Input: g1 to (k + Pg3 + IS + h) .....	2.3 Pf
Output: p to (k + Pg3 + IS + h) .....	1.9 Pf

**Pentode Section**

Grid No. 1 to Plate (Max.) .....	0.005 Pf
Input: g1 to (k + g3 + IS + g2 + h) .....	5.4 Pf
Output: p to (k + g3 + IS + g2 + h) .....	3.3 Pf
Grid No. 1 to Grid No. 2 .....	1.6 Pf

**RATINGS (Design Maximum Rating System)**

	Triode Section	Pentode Section
Plate Voltage (Max.) .....	275	275 Volts
Grid No. 2 Supply Voltage (Max.) .....	—	275 Volts
Grid No. 2 Voltage .....	See Rating Chart (Gen. Info. Sec.)	
Cathode Current (Max.).....	20	20 Ma
Plate Dissipation (Max.) .....	1.5	2.2 Watts
Grid No. 2 Dissipation (Max.) .....	—	0.45 Watt
Positive Grid No. 1 Voltage (Max.) .....	0	0 Volt
Maximum Grid No. 1 Circuit Resistance		
Self Bias (Max.) .....	1.0	0.5 Megohm
Fixed Bias (Max.) .....	0.5	0.25 Megohm
Control grid to cathode spacing of the pentode section of this type is of such low order of magnitude as to preclude the use of voltage between these elements of more than 30 volts dc or peak ac in commercial tube checkers and shorts indicating devices, particularly where mechanical excitation of the tube is employed.		

**CHARACTERISTICS AND TYPICAL OPERATION**

**Class A1 Amplifier**

	Triode Section		Pentode Section	
Plate Voltage .....	100	125	120	125 Volts
Grid No. 2 Voltage .....	—	—	90	125 Volts
Grid No. 1 Voltage .....	—	-1.0	—	-1.0 Volt
Cathode Bias Resistor .....	0.1	—	0.1	— Megohm
Plate Current .....	12.5	13	8.5	8 Ma
Grid No. 2 Current .....	—	—	2.8	2.5 Ma
Transconductance .....	8700	8500	13,000	11,000 $\mu$ mhos
Amplification Factor .....	—	40	—	—
Plate Resistance (Approx.) .....	—	4700	—	200,000 Ohms
Ec1 for Ib = 20 $\mu$ a (Approx.).....	-6.0	—	-2.5	— Volts

**NOTE:**

(1) Shield connected to cathode.



# HORIZONTAL DEFLECTION AMPLIFIER

**6GY5**  
16GY5, 21GY5

**Beam Power Pentode**

Construction..... Compactron T-12  
 Base ..... Button 12 Pin, E12-74  
 Top Cap ..... C1-3  
 Basing ..... 12DR  
 Outline ..... 12-79  
 Maximum Diameter ..... 1.563 In.  
 Maximum Seated Height ..... 3.250 In.  
 Maximum Overall Height ..... 3.625 In.

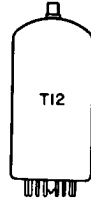
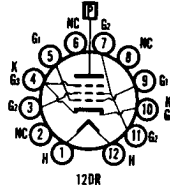

**ELECTRICAL DATA**

**HEATER OPERATION**

	21GY5	16GY5	6GY5
Heater Voltage.....	21	15.8	6.3 Volts
Heater Current .....	450	600	1500 Ma
Heater Warm-up Time .....	11	11	— Seconds
Maximum Heater-Cathode Voltage			
Heater Negative with Respect to Cathode			
Total DC and Peak.....			200 Volts
Heater Positive with Respect to Cathode			
DC .....			100 Volts
Total DC and Peak.....			200 Volts

**DIRECT INTERELECTRODE CAPACITANCES (Unshielded)**

Grid No. 1 to Plate .....	0.7 Pf
Input: g1 to (h + k + g3).....	22 Pf
Output: p to (h + k + g2 + g3) .....	9 Pf

**RATINGS (Design Maximum Rating System)**

**Horizontal Deflection Amplifier<sup>(1)</sup>**

DC Plate Supply Voltage (Boost + DC Power Supply) (Max.) .....	770 Volts
Peak Positive Pulse Plate Voltage .....	6500 Volts
Peak Negative Pulse Plate Voltage (Max.) .....	1500 Volts
Plate Dissipation (Max.) <sup>(2)</sup> .....	18 Watts
Peak Negative Grid No. 1 Voltage (Max.) .....	330 Volts
Grid No. 2 Voltage (Max.) .....	220 Volts
Grid No. 2 Dissipation (Max.) .....	3.5 Watts
Average Cathode Current (Max.).....	230 Ma
Peak Cathode Current (Max.).....	800 Ma
Grid No. 1 Circuit Resistance (Max.).....	1.0 Megohm
Bulb Temperature (At Hottest Point) (Max.) .....	220 °C

**CHARACTERISTICS AND TYPICAL OPERATION**

Plate Voltage .....	5000	130 Volts
Grid No. 2 Voltage .....	130	130 Volts
Grid No. 1 Voltage .....	—	-20 Volts
Plate Current .....	—	50 Ma
Grid No. 2 Current .....	—	1.75 Ma
Transconductance .....	—	9100 μmhos
Plate Resistance.....	—	11,000 Ohms
Amplification Factor <sup>(3)</sup> .....	—	4.7
Ec1 for Ib = 1.0 Ma (Approx.) .....	-66	-33 Volts

**INSTANTANEOUS PLATE KNEE VALUES**

Eb = 60 V; Ec2 = 130 V and Ec1 = 0  
 Ib = 410 Ma; and Ic2 = 26 Ma

**NOTES:**

- (1) For operation in a 525 line, 30 frame system as described in "Standards of Good Engineering Practice for Television Broadcast Stations; Federal Communications Commission," the duty cycle of the voltage pulse must not exceed 15% of one horizontal scanning cycle.
- (2) In stages operating with grid leak bias, an adequate cathode bias resistor or other suitable means is required to protect the tube in the absence of excitation.
- (3) Amplification factor with tube operating as a triode with 130 volts on the plate and Grid No. 2 and -20 volts on Grid No. 1.

**6GY6/6GX6**  
5GX6

Color Television Type

**GATED AGC AMP. and NOISE  
INVERTER or FM DETECTOR**

**Sharp Cutoff Pentode**

Construction ..... Miniature T-5½  
Base ..... Button 7 Pin, E7-1  
Basing ..... 7EN  
Outline ..... 5-2  
Maximum Diameter ..... 0.750 In.  
Maximum Seated Height ..... 1.875 In.  
Maximum Overall Height ..... 2.125 In.

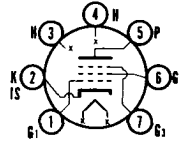

7EN

**ELECTRICAL DATA****HEATER OPERATION**

	5GX6	6GY6/6GX6
Heater Voltage.....	4.7	6.3 Volts
Heater Current .....	600	450 Ma
Heater Warm-up Time .....	11	11 Seconds
Maximum Heater-Cathode Voltage		
Heater Negative with Respect to Cathode		
Total DC and Peak.....		200 Volts
Heater Positive with Respect to Cathode		
DC .....		100 Volts
Total DC and Peak.....		200 Volts

**DIRECT INTERELECTRODE CAPACITANCES (Unshielded)**

Grid No. 1 to Plate .....	0.026 Pf
Grid No. 3 to Plate .....	1.6 Pf
Input: g1 to (k & IS + g3 + g2 + h).....	8 Pf
Input: g3 to (k & IS + p + g2 + g1 + h) .....	6.5 Pf
Grid No. 1 to Grid No. 2 .....	0.12 Pf

**RATINGS (Design Maximum Rating System)**

Plate Voltage (Max.) .....	300 Volts
Peak Positive Pulse Plate Voltage (Max.) <sup>(1)</sup> .....	600 Volts
Positive Grid No. 3 Voltage (Max.) .....	0 Volt
Negative Grid No. 3 Voltage (Max.) .....	100 Volts
Grid No. 2 Supply Voltage (Max.) .....	300 Volts
Positive Grid No. 1 Voltage (Max.) .....	0 Volt
Negative Grid No. 1 Voltage (Max.) .....	50 Volts
Plate Dissipation (Max.) .....	1.7 Watts
Grid No. 2 Input	
For Grid No. 2 Voltage to 150 Volts (Max.) .....	1.0 Watt
For Grid No. 2 Voltages Between 150 to 300 Volts .....	See Rating Chart (Gen. Info. Sec.)
Grid No. 3 Circuit Resistance (Max.) .....	0.68 Megohm
Grid No. 1 Circuit Resistance	
Fixed Bias (Max.) .....	0.22 Megohm
Self Bias (Max.) .....	0.47 Megohm

**CHARACTERISTICS AND TYPICAL OPERATION**

Plate Voltage .....	150 Volts
Grid No. 3 Voltage .....	0 Volt
Grid No. 2 Voltage .....	100 Volts
Cathode Resistor .....	180 Ohms
Plate Current .....	3.7 Ma
Grid No. 2 Current .....	3 Ma
Transconductance (G1 to P) .....	3700 μmhos
Transconductance (G3 to P) .....	750 μmhos
Plate Resistance.....	140,000 Ohms
Ec1 for Ib = 20 μa (Approx.).....	-4.5 Volts
Ec3 for Ib = 20 μa (Approx.).....	-7 Volts

**NOTE:**

(1) The duration of the pulse must not exceed 15% of one horizontal scanning cycle. In a 525-line, 30-frame system, 15% of one horizontal scanning cycle is 10 μsec.

**RF AMPLIFIER; AUTODYNE MIXER  
and AFC in FM RECEIVERS**

**6G Y8**

**Triple Triode**

Construction ..... Miniature T-6½  
 Base ..... Button 9 Pin, E9-1  
 Basing ..... 9MB  
 Outline ..... 6-2  
 Maximum Diameter ..... 0.875 In.  
 Maximum Seated Height ..... 1.937 In.  
 Maximum Overall Height ..... 2.187 In.

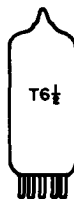
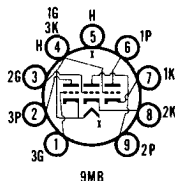

**ELECTRICAL DATA  
HEATER OPERATION**

Heater Voltage ..... 6.3 Volts  
 Heater Current ..... 450 Ma  
 Maximum Heater-Cathode Voltage  
 Heater Negative with Respect to Cathode ..... 100 Volts  
 Heater Positive with Respect to Cathode ..... 100 Volts

**DIRECT INTERELECTRODE CAPACITANCES**

	Section 1 <sup>(1)</sup>		Section 2 <sup>(1)</sup>		Section 3 <sup>(1)</sup>	
	Unsh.	Sh.	Unsh.	Sh.	Unsh.	Sh.
Grid to Plate	1.6	1.5	1.4	1.4	1.5	1.5 Pf
Input	5.0	5.0	2.4	2.6	2.2	2.4 Pf
Output	1.6	2.4	0.4	1.4	0.2	1.0 Pf
Heater to Cathode	5.0	5.0	2.8	2.8	—	— Pf

**RATINGS (Design Maximum Rating System) (Each Section)**

Plate Voltage (Max.) ..... 330 Volts  
 Plate Dissipation (Each Plate) (Max.) ..... 2.0 Watts  
 Plate Dissipation (Plates 1, 2, and 3) (Max.) ..... 5.0 Watts  
 Positive Grid Voltage (Max.) ..... 0 Volt

**CHARACTERISTICS AND TYPICAL OPERATION**

**Class A1 Amplifier**

	Section 1 <sup>(1)</sup>	Section 2 & 3 <sup>(1)</sup>
Plate Voltage	125	125 Volts
Grid Voltage	—	-1.0 Volts
Cathode Resistor	220	— Ohms
Plate Current	4.5	4.5 Ma
Plate Resistance	14,000	14,000 Ohms
Transconductance	4500	4500 μmhos
Amplification Factor	63	63
Ec for Ib = 20 μa (Approx.)	—	-4 Volts

**NOTE:**

(1) Section 1 connects to pins 4, 6, and 7. Section 2 connects to pins 3, 8, and 9. Section 3 connects to pins 1, 2, and 4.

**AUDIO POWER AMPLIFIER**

**6G Z5**

**4G Z5**

**Power Pentode**

Construction ..... Miniature T-5½  
 Base ..... Button 7 Pin, E7-1  
 Basing ..... 7CV  
 Outline ..... 5-2  
 Maximum Diameter ..... 0.750 In.  
 Maximum Seated Height ..... 1.875 In.  
 Maximum Overall Height ..... 2.125 In.

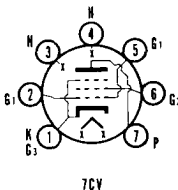

**ELECTRICAL DATA  
HEATER OPERATION**

Heater Voltage ..... 4G Z5 4.0  
 Heater Current ..... 600  
 Heater Warm-up Time ..... 11  
 6G Z5 6.3 Volts  
 380 Ma  
 — Seconds

<b>Maximum Heater-Cathode Voltage</b>		
Heater Negative with Respect to Cathode		
Total DC and Peak.....		200 Volts
Heater Positive with Respect to Cathode		
DC .....		100 Volts
Total DC and Peak.....		200 Volts
<b>DIRECT INTERELECTRODE CAPACITANCES (Unshielded)</b>		
Grid No. 1 to Plate .....	0.24 Pf	
Input: $g_1$ to $(h + k + g_2)$ .....	8.5 Pf	
Output: $p$ to $(h + k + g_2)$ .....	3.8 Pf	
<b>RATINGS (Design Maximum Rating System)</b>		
Plate Voltage (Max.) .....	300 Volts	
Grid No. 2 Voltage (Max.).....	300 Volts	
Positive DC Grid No. 1 Voltage (Max.) .....	0 Volts	
Plate Dissipation (Max.) .....	4.8 Watts	
Grid No. 2 Dissipation—Continuous (Max.) .....	1.1 Watts	
Cathode Current—Average (Max.) .....	30 Ma	
Grid No. 1 Circuit Resistance		
Fixed Bias (Max.) .....	0.5 Megohm	
Cathode Bias (Max.) .....	1.0 Megohm	
Bulb Temperature (Max.) .....	200 °C	
<b>CHARACTERISTICS AND TYPICAL OPERATION</b>		
<b>Class A1 Audio Amplifier</b>		
Plate Supply Voltage.....	250	250 Volts
Grid No. 2 Supply Voltage.....	250	250 Volts
Cathode Resistor .....	270	270 Ohms
Peak Audio Grid No. 1 Voltage .....	9.8	2.0 Volts
Zero Signal Plate Current .....	16	16 Ma
Maximum Signal Plate Current .....	16	16 Ma
Zero Signal Grid No. 2 Current .....	2.7	2.7 Ma
Maximum Signal Grid No. 2 Current .....	5.0	5.0 Ma
Transconductance .....	—	8400 $\mu$ mhos
Plate Resistance (Approx.) .....	—	0.15 Megohm
Load Resistance .....	15,000	15,000 Ohms
Total Harmonic Distortion .....	10	10 Percent
Power Output .....	1.8	1.1 Watts

**6HA5/6HM5**  
 4HA5/PC900, 4HM5,  
 3HA5/3HM5, 2HA5, 2HM5

Color Television Type  
**VHF AMPLIFIER**

**Shielded Triode**

Construction ..... Miniature T-5½  
 Base ..... Button 7 Pin, E7-1  
 Basing ..... 7GM  
 Outline ..... 5-1  
 Maximum Diameter ..... 0.750 In.  
 Maximum Seated Height ..... 1.500 In.  
 Maximum Overall Height ..... 1.750 In.

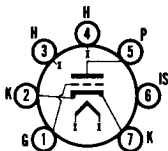

**ELECTRICAL DATA  
 HEATER OPERATION**

	7GM			
	2HA5 2HM5	3HA5/ 3HM5	4HA5/PC900 4HM5	6HA5/ 6HM5
Heater Voltage.....	2.4	2.9	4.0	6.3 Volts
Heater Current .....	600	450	300	185 Ma
Heater Warm-up Time .....	11	11	11	— Seconds
<b>Maximum Heater-Cathode Voltage</b>				
Heater Negative with Respect to Cathode				
Total DC and Peak.....				100 Volts
Heater Positive with Respect to Cathode				
Total DC and Peak.....				100 Volts

<b>DIRECT INTERELECTRODE CAPACITANCES (Shielded)<sup>(1)</sup></b>	
Output .....	3.0 Pf
Input .....	4.5 Pf
Plate to Grid .....	0.34 Pf
Cathode to Heater .....	2.5 Pf
<b>RATINGS (Design Maximum Rating System)</b>	
Plate Voltage (Max.) .....	200 Volts
Grid Voltage (Max.).....	-50 Volts
Cathode Current (Max.).....	20 Ma
Plate Dissipation (Max.).....	2.6 Watts
Grid Circuit Resistance .....	1 Megohm

**CHARACTERISTICS AND TYPICAL OPERATION**

Plate Voltage .....	120	135 Volts
Grid Voltage .....	0	-1 Volt
Plate Current .....	15.0	12.5 Ma
Transconductance .....	18,000	14,500 $\mu$ mhos
Amplification Factor .....	82	78
Grid Cutoff Bias		
GM = 150 $\mu$ mhos .....	-5.1	-5.7 Volts
GM = 1500 $\mu$ mhos .....	—	-2.7 Volts
Grid Resistance.....	0.1	0 Megohm
Hot Input Resistance <sup>(1)</sup> .....	—	1000 Ohms
Hot Input Capacitance <sup>(2)</sup> .....	—	8.5 Pf
Noise Figure <sup>(3)</sup> .....	4.0	4.2 db

**NOTES:**

- (1) With JEDEC Shield No. 316 connected to Pin No. 2.
- (2) Measured at 200 MHz with plate at signal ground  $E_{c1} = -1.5$  volts.
- (3) In a 200 MHz noise matched, optimized, neutralized grounded cathode, triode amplifier stage.

**HORIZONTAL DEFLECTION  
AMPLIFIER**

**6HB5**  
21HB5

**Beam Power Pentode**

Construction.....	Compactron T-12
Base .....	Button 12 Pin, E12-74
Basing .....	12BJ
Outline .....	12-58
Maximum Diameter .....	1.563 In.
Maximum Seated Height .....	3.000 In.
Maximum Overall Height .....	3.375 In.

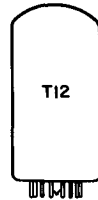
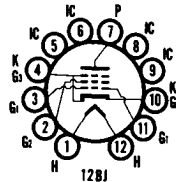

**ELECTRICAL DATA**

**HEATER OPERATION**

	<b>21HB5</b>	<b>6HB5</b>
Heater Voltage.....	21	6.3 Volts
Heater Current .....	450	1500 Ma
Heater Warm-up Time .....	11	— Seconds
Maximum Heater-Cathode Voltage		
Heater Negative with Respect to Cathode		
Total DC and Peak.....		200 Volts
Heater Positive with Respect to Cathode		
DC .....		100 Volts
Total DC and Peak.....		200 Volts

**DIRECT INTERELECTRODE CAPACITANCES (Unshielded)**

Grid No. 1 to Plate: (g1 to p) .....	0.4 Pf
Input: g1 to (h + k + g2 + bp).....	22 Pf
Output: p to (h + k + g2 + bp).....	9.0 Pf

**RATINGS (Design Maximum Rating System)**

<b>Horizontal-Deflection Amplifier Service<sup>(1)</sup></b>		
DC Plate-Supply Voltage (Boost + DC Power Supply) (Max.) .....		770 Volts
Peak Positive Pulse Plate Voltage (Max.) .....		6000 Volts
Peak Negative Pulse Plate Voltage (Max.) .....		1500 Volts
Screen Voltage (Max.) .....		220 Volts
Negative DC Grid No. 1 Voltage (Max.) .....		55 Volts
Peak Negative Grid No. 1 Voltage (Max.) .....		330 Volts
Plate Dissipation (Max.) <sup>(2)</sup> .....		18 Watts
Screen Dissipation (Max.) .....		3.5 Watts
DC Cathode Current (Max.) .....		230 Ma
Peak Cathode Current (Max.) .....		800 Ma
Grid No. 1 Circuit Resistance (Max.) .....		1.0 Megohm
Bulb Temperature at Hottest Point (Max.).....		220 °C

**CHARACTERISTICS AND TYPICAL OPERATION**

Plate Voltage .....	5000	60	130 Volts
Screen Voltage.....	130	130	130 Volts
Grid No. 1 Voltage .....	—	0 <sup>(3)</sup>	-20 Volts
Plate Resistance (Approx.) .....	—	—	11,000 Ohms
Transconductance .....	—	—	9100 $\mu$ mhos
Plate Current .....	—	410	50 Ma

Screen Current .....	—	24	1.75 Ma
Grid No. 1 Voltage (Approx.) .....			
I <sub>b</sub> = 1.0 Ma .....	-66	—	-33 Volts
Triode Amplification Factor <sup>(4)</sup> .....	—	—	4.7

**NOTES:**

- (1) For operation in a 525 line, 30 frame system as described in "Standards of Good Engineering Practice for Television Broadcast Stations; Federal Communications Commission," the duty cycle of the voltage pulse must not exceed 15% of one horizontal scanning cycle.
- (2) In stages operating with grid-leak bias, an adequate cathode-bias resistor or other suitable means is required to protect the tube in the absence of excitation.
- (3) Applied for short interval (two seconds maximum) so as not to damage tube.
- (4) Triode connection (screen tied to plate) with E<sub>b</sub> = E<sub>c2</sub> = 130 volts and E<sub>c1</sub> = -20 volts.



**Beam Power Pentode**

Construction ..... Miniature T-5½  
 Base ..... Button 9 Pin, E9-1  
 Basing ..... 9NW  
 Outline ..... 6-4  
     Maximum Diameter ..... 0.875 In.  
     Maximum Seated Height ..... 2.812 In.  
     Maximum Overall Height ..... 3.062 In.

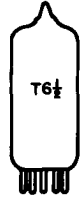
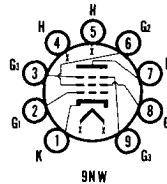

**ELECTRICAL DATA**

**HEATER OPERATION**

	<b>15HB6</b>	<b>6HB6</b>
Heater Voltage .....	14.7	6.3 Volts
Heater Current .....	300	760 Ma
Heater Warm-up Time .....	11	— Seconds
Maximum Heater-Cathode Voltage		
Heater Negative with Respect to Cathode		
Total DC and Peak .....		200 Volts
Heater Positive with Respect to Cathode		
DC .....		100 Volts
Total DC and Peak .....		200 Volts

**DIRECT INTERELECTRODE CAPACITANCES**

Grid No. 1 to Plate .....	0.18 Pf
Input .....	13 Pf
Output .....	8 Pf

**RATINGS (Design Maximum Rating System)**

Plate Voltage (Max.) .....	350 Volts
Peak Positive Plate Voltage (Max.) .....	2500 Volts
Grid No. 2 Voltage (Max.) .....	300 Volts
Grid No. 1 Voltage (Max.) .....	-100 Volts
Plate Dissipation (Max.) .....	10 Watts
Grid No. 2 Dissipation (Max.) .....	2 Watts
Grid No. 1 Circuit Resistance	
Fixed Bias (Max.) .....	1.0 Megohm
Cathode Bias (Max.) .....	2.2 Megohms

**CHARACTERISTICS AND TYPICAL OPERATION**

Plate Voltage .....	250	250 Volts
Grid No. 2 Voltage .....	125	250 Volts
Plate Current .....	40	40 Ma
Grid No. 2 Current .....	4.2	6.2 Ma
Cathode Resistor .....	3.3	100 Ohms
Amplification Factor (G1 to G2) .....	—	33
Transconductance .....	24,000	20,000 μmhos
Plate Resistance .....	28,000	24,000 Ohms
G1 Voltage for I <sub>b</sub> = 100 μa .....	-6.4	-13 Volts

**INSTANTANEOUS PLATE KNEE CHARACTERISTICS**

E<sub>b</sub> = 60 Volts; E<sub>c2</sub> = 250 Volts; E<sub>c1</sub> = 0 Volt;  
 I<sub>b</sub> = 150 Ma; I<sub>c2</sub> = 37 Ma

Color Television Type  
**VHF OSCILLATOR and MIXER**

**6HB7**  
5HB7

**Medium Mu Triode and Sharp Cutoff Pentode**

Construction ..... Miniature T-6½  
 Base ..... Button 9 Pin, E9-1  
 Basing ..... 9QA  
 Outline ..... 6-2  
 Maximum Diameter ..... 0.875 In.  
 Maximum Seated Height ..... 1.937 In.  
 Maximum Overall Height ..... 2.187 In.

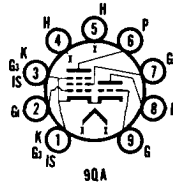

**ELECTRICAL DATA  
HEATER OPERATION**

	<b>5HB7</b>	<b>6HB7</b>
Heater Voltage.....	4.7	6.3 Volts
Heater Current .....	600	450 Ma
Heater Warm-up Time .....	11	11 Seconds
Maximum Heater-Cathode Voltage		
Heater Negative with Respect to Cathode		200 Volts
Total DC and Peak.....		
Heater Positive with Respect to Cathode		
DC .....		100 Volts
Total DC and Peak.....		200 Volts

**DIRECT INTERELECTRODE CAPACITANCES (Shielded)**

<b>Triode Section</b>		
Grid to Plate .....		1.9 Pf
Input .....		3.0 Pf
Output .....		1.9 Pf
<b>Pentode Section</b>		
Grid No. 1 to Plate (Max.).....		0.01 Pf
Input .....		5.0 Pf
Output .....		3.4 Pf

**AVERAGE PLATE CHARACTERISTICS  
(Pentode Section)**

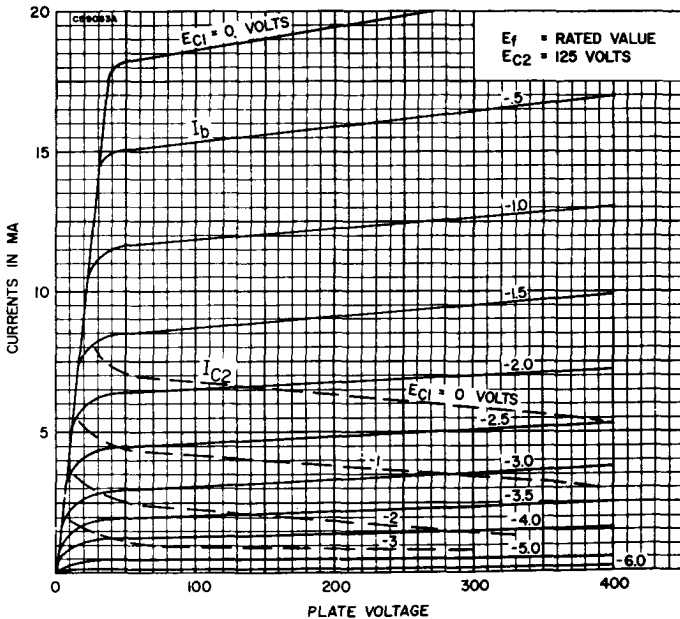

**AVERAGE PLATE CHARACTERISTICS  
(Triode Section)**

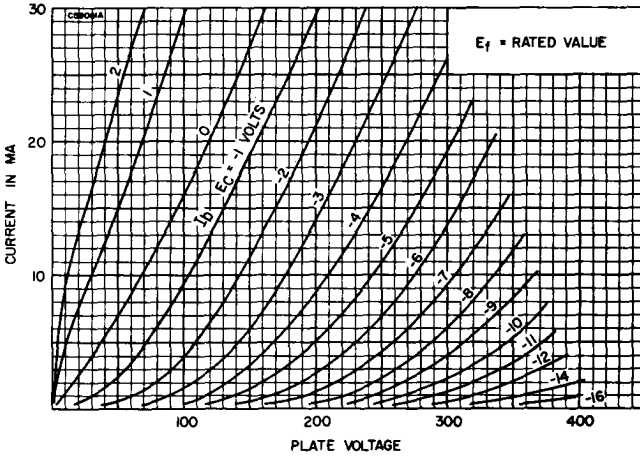

**RATINGS (Design Maximum Rating System)**

	<b>Triode Section</b>	<b>Pentode Section</b>
Plate Voltage (Max.) .....	330	330 Volts
Grid No. 2 Supply Voltage (Max.) .....	—	330 Volts
Grid No. 2 Voltage .....	See Rating Chart (Gen. Info. Sec.)	
Plate Dissipation (Max.) .....	2.5	3.1 Watts
Grid No. 2 Dissipation (Max.) .....	—	0.55 Watt
Positive Grid No. 1 Voltage (Max.) .....	0	0 Volt

**CHARACTERISTICS AND TYPICAL OPERATION**

	<b>Triode Section</b>	<b>Pentode Section</b>
<b>Class A1 Amplifier</b>		
Plate Voltage .....	150	125 Volts
Grid No. 2 Voltage .....	—	125 Volts
Grid No. 1 Voltage .....	—	-1.0 Volts
Cathode Bias Resistor .....	56	— Ohms
Plate Current .....	18	12 Ma
Grid No. 2 Current .....	—	4 Ma
Transconductance .....	8500	6400 $\mu$ mhos
Amplification Factor .....	40	—
Plate Resistance (Approx.) .....	5000	200,000 Ohms
$E_{c1}$ for $I_b = 10 \mu$ a (Approx.) .....	-12	-9 Volts

6HD7

VHF OSCILLATOR and MIXER

**Medium Mu Triode and Sharp Cutoff Pentode**

- Construction ..... Miniature T-6½
- Base ..... Button 9 Pin, E9-1
- Basing ..... .9QA
- Outline ..... 6-2
- Maximum Diameter ..... 0.875 In.
- Maximum Seated Height ..... 1.937 In.
- Maximum Overall Height ..... 2.187 In.

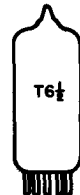
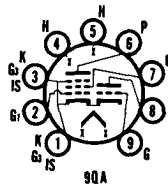

**ELECTRICAL DATA  
HEATER OPERATION**

Heater Voltage .....	6.3 Volts
Heater Current .....	450 Ma
Heater Warm-up Time .....	11 Seconds



Maximum Heater-Cathode Voltage	
Heater Negative with Respect to Cathode	
Total DC and Peak .....	200 Volts
Heater Positive with Respect to Cathode	
DC .....	100 Volts
Total DC and Peak .....	200 Volts

**DIRECT INTERELECTRODE CAPACITANCES (Shielded)<sup>(1)</sup>**

<b>Triode:</b>	
Grid to Plate .....	1.35 Pf
Input .....	2.45 Pf
Output .....	0.8 Pf
<b>Pentode:</b>	
Grid 1 to Plate .....	0.008 Pf
Input .....	4.6 Pf
Output .....	1.8 Pf
Grid 1 to Grid 2 .....	1.3 Pf

**RATINGS (Design Maximum Rating System)**

	<b>Triode Section</b>	<b>Pentode Section</b>
Plate Voltage (Max.) .....	275	275 Volts
Grid 2 Supply Voltage (Max.) .....	—	275 Volts
Grid 2 Voltage .....	See Rating Chart (Gen. Info. Sec.)	
Plate Dissipation (Max.) .....	1.5	2.2 Watts
Grid 2 Dissipation (Max.) .....	—	0.45 Watts
Positive Grid 1 Voltage (Max.) .....	0	0 Volts
Negative Grid 1 Voltage (Max.) .....	40	40 Volts
Cathode Current (Max.) .....	20	20 Ma
Grid 1 Circuit Resistance		
Fixed Bias (Max.) .....	0.5	0.25 Megohm
Cathode Resistor Bias .....	1.0	0.5 Megohm

**CHARACTERISTICS AND TYPICAL OPERATION**

**Triode Unit:**

Plate Voltage .....	100	125 Volts
Grid Voltage .....	—	-1.0 Volt
Grid Circuit Resistance .....	0.1	— Megohm
Amplification Factor .....	40	—
Plate Resistance .....	4880	— Ohms
Transconductance .....	8200	9500 $\mu$ mhos
Plate Current .....	14	19 Ma
Grid Cutoff Voltage <sup>(2)</sup> .....	-5.0	-6.0 Volts

**Pentode Unit:**

Plate Voltage .....	120	125 Volts
Grid 2 Voltage .....	90	125 Volts
Grid 1 Voltage .....	—	-1.0 Volt
Grid 1 Circuit Resistance .....	0.1	— Megohm
Plate Resistance .....	70,000	— Ohms
Transconductance .....	8000	7000 $\mu$ mhos
Plate Current .....	10.5	12 Ma
Grid 2 Current .....	3.0	3.5 Ma
Grid 1 Cutoff Voltage <sup>(2)</sup> .....	-2.5	-6.5 Volts

**NOTES:**

- (1) With external shield connected to cathode.
- (2) For a plate current of 20  $\mu$ a.

Color Television Type

## VERTICAL DEFLECTION AMPLIFIER

# 6HE5

**Beam Power Pentode**

Construction..... Compactron T-9  
 Base ..... Button 12 Pin, E12-70  
 Basing ..... 12EY  
 Outline ..... 9-60  
 Maximum Diameter ..... 1.188 In.  
 Maximum Seated Height ..... 2.500 In.  
 Maximum Overall Height ..... 2.875 In.

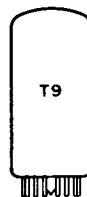
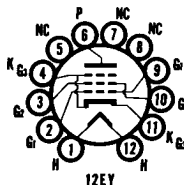

**ELECTRICAL DATA  
HEATER OPERATION**

Heater Voltage .....	6.3 Volts
Heater Current .....	800 Ma

<b>Maximum Heater-Cathode Voltage</b>	
Heater Negative with Respect to Cathode	
Total DC and Peak .....	200 Volts
Heater Positive with Respect to Cathode	
DC .....	100 Volts
Total DC and Peak .....	200 Volts

**DIRECT INTERELECTRODE CAPACITANCES (Unshielded)**

Grid No. 1 to Plate (Max.) .....	0.54 Pf
Input: g1 to (h + k + g2 + g3) .....	9.5 Pf
Output: p to (h + k + g2 + g3) .....	7.0 Pf

**RATINGS (Design Maximum Rating System)**

**Vertical Deflection Amplifier<sup>(1)</sup>**

Plate Voltage (Max.) .....	350 Volts
Peak Positive Pulse Plate Voltage (Abs. Max.) .....	2500 Volts
Grid No. 2 Voltage (Max.) .....	300 Volts
Plate Dissipation (Max.) <sup>(2)</sup> .....	12 Watts
Grid No. 2 Input (Max.) <sup>(2)</sup> .....	2.75 Watts
Average Cathode Current (Max.) .....	75 Ma
Peak Cathode Current (Max.) .....	260 Ma
Bulb Temperature (Max.) .....	200 °C
Grid Circuit Resistance	
Fixed Bias (Max.) .....	1.0 Megohm
Cathode Bias (Max.) .....	2.2 Megohms

**CHARACTERISTICS AND TYPICAL OPERATION**

Plate Voltage .....	250 Volts
Grid No. 2 Voltage .....	250 Volts
Grid No. 1 Voltage .....	-20 Volts
Plate Current .....	43 Ma
Grid No. 2 Current .....	3.5 Ma
Transconductance .....	4100 μmhos
Plate Resistance (Approx.) .....	5000 Ohms
Ec1 Voltage for Ib = 100 μa (Approx.) .....	-50 Volts

**INSTANTANEOUS PLATE KNEE VALUES**

Eb = 60 V; Ec2 = 250 V; Ec1 = 0 V;

Ib = 180 Ma and Ic2 = 20 Ma

**NOTES:**

- (1) For operation in a 525 line, 30 frame system as described in "Standards of Good Engineering Practice for Television Broadcast Stations; Federal Communications Commission," the duty cycle of the voltage pulse must not exceed 15% of one horizontal scanning cycle.
- (2) In stages operating with grid-leak bias, an adequate bias resistor or other suitable means is required to protect the tube in the absence of excitation.

**AVERAGE PLATE CHARACTERISTICS**

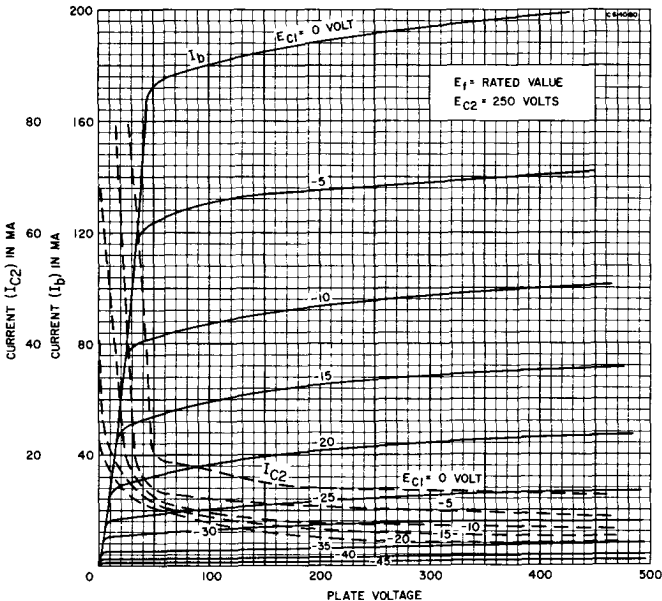

**DAMPER and HORIZONTAL DEFLECTION AMPLIFIER**

**6HE7**

12HE7, 33HE7, 38HE7, 58HE7

**High Perveance Diode and Beam Power Pentode**

Construction.....Compactron T-12  
 Base .....Button 12 Pin, E12-74  
 Basing .....12FS  
 Outline .....12-57  
 Maximum Diameter .....1.562 In.  
 Maximum Seated Height .....2.750 In.  
 Maximum Overall Height .....3.125 In.

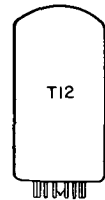
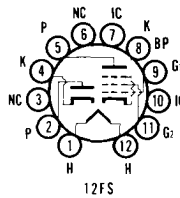

**ELECTRICAL DATA**

**HEATER OPERATION**

	58HE7	38HE7	33HE7	12HE7	6HE7
Heater Voltage.....	58	37.8	33.6	12.6	6.3 Volts
Heater Current.....	300	450	450	1350	2700 Ma
Heater Warm-up Time.....	11	11	11	—	— Seconds
Maximum Heater Cathode Voltage					

Diode	Pentode
Heater Negative with Respect to Cathode	
DC.....	— Volts
Total DC and Peak.....	200 Volts
Heater Positive with Respect to Cathode	
DC.....	100 Volts
Total DC and Peak.....	200 Volts

**DIRECT INTERELECTRODE CAPACITANCES (Unshielded)**

Diode Section	
Cathode to Plate and Heater.....	8.0 Pf
Plate to Cathode and Heater.....	7.0 Pf
Heater to Cathode.....	1.6 Pf

**Pentode Section**

Grid No. 1 to Plate.....	0.38 Pf
Input: $g_1$ to $(h + k + g_2 + bp)$ .....	19 Pf
Output: $p$ to $(h + k + g_2 + bp)$ .....	8.0 Pf

**RATINGS (Design Maximum Rating System)**

**Horizontal Deflection Amplifier Service<sup>(1)</sup>**

Pentode Section	
DC Plate Supply Voltage (Boost + DC Power Supply) (Max.).....	500 Volts
Peak Positive Pulse Plate Voltage (Max.).....	5000 Volts
Peak Negative Pulse Plate Voltage (Max.).....	0 Volt
Screen Voltage (Max.).....	150 Volts
Negative DC Grid No. 1 Voltage (Max.).....	55 Volts
Peak Negative Grid No. 1 Voltage (Max.).....	330 Volts
Plate Dissipation (Max.) <sup>(2)</sup> .....	10.0 Watts
Screen Dissipation (Max.).....	3.5 Watts
Screen Dissipation (With Plate Dissipation Limited to 9 Watts) (Max.).....	4.0 Watts
DC Cathode Current (Max.).....	230 Ma
Peak Cathode Current (Max.).....	800 Ma
Grid No. 1 Circuit Resistance (Max.).....	1.0 Megohm

**TV Damper Service<sup>(1)</sup>**

Diode Section	
Peak Inverse Plate Voltage (Max.).....	4200 Volts
Steady State Peak Plate Current (Max.).....	1200 Ma
DC Output Current (Max.).....	200 Ma
Bulb Temperature at Hottest Point (Max.).....	200 °C

**CHARACTERISTICS AND TYPICAL OPERATION**

**Pentode Section**

Plate Voltage.....	5000	50	130 Volts
Screen Voltage.....	130	130	130 Volts
Grid No. 1 Voltage.....	—	0	-22 Volts
Plate Resistance (Approx.).....	—	—	6200 Ohms
Transconductance.....	—	—	8800 $\mu$ mhos
Plate Current.....	—	450	60 Ma
Screen Current.....	—	40	2.8 Ma
Grid No. 1 Voltage (Approx.)			
$I_b = 1.0$ Ma.....	-80	—	-39 Volts
Triode Amplification Factor <sup>(3)</sup> .....	—	—	4.2

**Diode Section**

Tube Voltage Drop	
$I_b = 250$ Ma DC.....	21 Volts

**NOTES:**

- (1) For operation in a 525 line, 30 frame system as described in "Standards of Good Engineering Practice for Television Broadcast Stations; Federal Communications Commission," the duty cycle of the voltage pulse must not exceed 15% of one horizontal scanning cycle.
- (2) In stages operating with grid leak bias, an adequate cathode bias resistor or other suitable means is required to protect the tube in the absence of excitation.
- (3) Amplification factor with tube operating as a triode with 130 volts on the plate and Grid No. 2 and -22 volts on Grid No. 1.

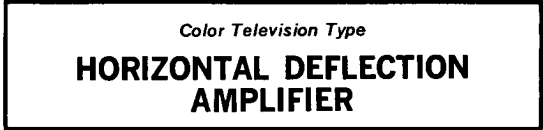

**Beam Power Pentode**

Construction..... Compactron T-12  
 Base ..... Button 12 Pin, E12-74  
 Top Cap ..... C1-1  
 Basing ..... 12FB  
 Outline ..... 12-89  
 Maximum Diameter ..... 1.563 In.  
 Maximum Seated Height ..... 3.750 In.  
 Maximum Overall Height ..... 4.125 In.

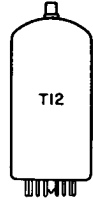
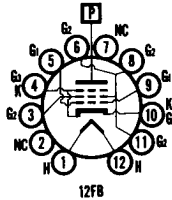

**ELECTRICAL DATA**

**HEATER OPERATION**

Heater Voltage.....	6.3 Volts
Heater Current .....	2250 Ma
Maximum Heater-Cathode Voltage	
Heater Negative with Respect to Cathode	
Total DC and Peak.....	200 Volts
Heater Positive with Respect to Cathode	
DC .....	100 Volts
Total DC and Peak.....	200 Volts

**DIRECT INTERELECTRODE CAPACITANCES (Unshielded)**

Grid to Plate .....	0.56 Pf
Input: g1 to (h + k + g2 + g3) .....	24 Pf
Output: p to (h + k + g2 + g3) .....	10 Pf

**RATINGS (Design Maximum Rating System)**

**Horizontal Deflection Amplifier<sup>(1)</sup>**

DC Plate Supply Voltage (Boost + DC Power Supply) (Max.) .....	990 Volts
Peak Positive Plate Voltage (Max.) .....	7500 Volts
Peak Negative Plate Voltage (Max.) .....	1100 Volts
Grid No. 2 Voltage (Max.) .....	190 Volts
Peak Negative Grid No. 1 Voltage (Max.) .....	250 Volts
Plate Dissipation (Max.) <sup>(2)</sup> .....	28 Watts
Grid No. 2 Input (Max.) .....	5.5 Watts
Average Cathode Current (Max.) .....	315 Ma
Peak Cathode Current (Max.) .....	1100 Ma
Grid No. 1 Circuit Resistance (Max.) .....	1.0 Megohm
Bulb Temperature (at Hottest Point) (Max.) .....	225 °C

**CHARACTERISTICS AND TYPICAL OPERATION**

Plate Voltage .....	175 Volts
Grid No. 2 Voltage .....	125 Volts
Grid No. 1 Voltage .....	-25 Volts
Plate Current .....	125 Ma
Grid No. 2 Current .....	4.5 Ma
Transconductance .....	11,300 μmhos
Amplification Factor <sup>(3)</sup> .....	3
Plate Resistance .....	5600 Ohms
Ec1 for Ib = 1 Ma (Approx.) .....	-54 Volts

**INSTANTANEOUS PLATE KNEE VALUES**

Eb = 70 V; Ec2 = 125 V and Ec1 = 0 V;  
 Ib = 570 Ma; and Ic2 = 34 Ma

**NOTES:**

- (1) For operation in a 525 line, 30 frame system as described in "Standards of Good Engineering Practice for Television Broadcast Stations; Federal Communications Commission," the duty cycle of the voltage pulse must not exceed 15% of one horizontal scanning cycle.
- (2) In stages operating with grid leak bias, an adequate cathode bias resistor or other suitable means is required to protect the tube in the absence of excitation.
- (3) Amplification factor with tube operating as a triode with 125 volts on the plate and Grid No. 2, and -25 volts on Grid No. 1.

Color Television Type

**SYNC SEP. or VOLTAGE AMP. (T)  
VIDEO AMPLIFIER (P)**

**6HF8**  
10HF8

**High Mu Triode and Sharp Cutoff Pentode**

Construction .....Miniature T-6½  
 Base .....Button 9 Pin, E9-1  
 Basing .....9DX  
 Outline .....6-3  
     Maximum Diameter .....0.875 In.  
     Maximum Seated Height .....2.375 In.  
     Maximum Overall Height .....2.625 In.

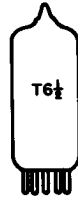
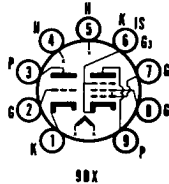

**ELECTRICAL DATA**

**HEATER OPERATION**

	<b>10HF8</b>	<b>6HF8</b>
Heater Voltage.....	10.5	6.3 Volts
Heater Current .....	450	750 Ma
Heater Warm-up Time .....	11	— Seconds
<b>Maximum Heater-Cathode Voltage</b>		
Heater Negative with Respect to Cathode		
Total DC and Peak.....		200 Volts
Heater Positive with Respect to Cathode		
DC .....		100 Volts
Total DC and Peak.....		200 Volts

**DIRECT INTERELECTRODE CAPACITANCES (Unshielded)**

**Triode**

Grid to Plate .....	3.5 Pf
Input: g to (Tk, Pk + G3 + IS, h) .....	2.8 Pf
Output: p to (Tk, Pk + G3 + IS, h) .....	2.6 Pf

**Pentode**

Grid No. 1 to Plate (Max.) .....	0.1 Pf
Input: g1 to (k + IS + g3, g2, h).....	10 Pf
Output: p to (k + IS + g3, g2, h).....	4.2 Pf

**Coupling**

Triode Grid to Pentode Plate (Max.) .....	0.015 Pf
---	----------

**RATINGS (Design Maximum Rating System)**

	<b>Triode Section</b>	<b>Pentode Section</b>
Plate Voltage (Max.) .....	330	330 Volts
Grid No. 2 Supply Voltage (Max.) .....	—	330 Volts
Grid No. 2 Voltage .....	See Rating Chart (Gen. Info. Sec.)	
Plate Dissipation (Max.) .....	1.0	5 Watts
Grid No. 2 Dissipation (Max.) .....	—	1.1 Watts
Positive Grid No. 1 Voltage (Max.) .....	0	0 Volt
Grid No. 1 Circuit Resistance		
Fixed Bias (Max.) .....	0.5	0.25 Megohm
Self Bias (Max.) .....	1.0	1.0 Megohm

**CHARACTERISTICS AND TYPICAL OPERATION**

**Class A1 Amplifier**

	<b>Triode Section</b>	<b>Pentode Section</b>
Plate Voltage .....	200	200 Volts
Grid No. 2 Voltage .....	—	125 Volts
Grid No. 1 Voltage .....	-2	— Volts
Cathode Bias Resistor .....	—	68 Ohms
Plate Current .....	4	25 Ma
Grid No. 2 Current .....	—	7 Ma
Transconductance .....	4000	12,500 μmhos
Amplification Factor .....	70	—
Plate Resistance (Approx.) .....	17,500	75,000 Ohms
Ec for Ib = 20 μa (Approx.) .....	-6	— Volts
Ec1 for Ib = 100 μa (Approx.) .....	—	-9 Volts

**INSTANTANEOUS PLATE KNEE CHARACTERISTICS**

Eb = 45 V; Ec2 = 125 V; and Ec1 = 0 V  
 Ib = 40 Ma (Approx.) and Ic2 = 15 Ma (Approx.)

**AVERAGE PLATE CHARACTERISTICS  
(Pentode Section)**

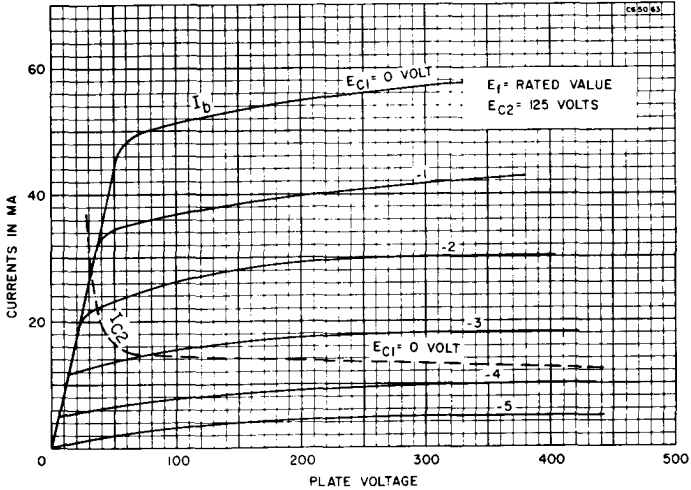

**6HG5**

**AUDIO POWER AMPLIFIER**

**Beam Power Pentode**

- Construction ..... Miniature T-5½
- Base ..... Button 7 Pin, E7-1
- Basing ..... 7BZ
- Outline ..... 5-3
  - Maximum Diameter ..... 0.750 In.
  - Maximum Seated Height ..... 2.375 In.
  - Maximum Overall Height ..... 2.625 In.

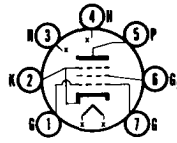

7BZ

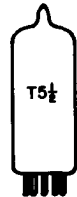

**ELECTRICAL DATA**

**HEATER OPERATION**

- Heater Voltage ..... 6.3 Volts
- Heater Current ..... 450 Ma
- Heater Warm-up Time<sup>(1)</sup> ..... 14 Seconds
- Maximum Heater-Cathode Voltage
  - Heater Negative with Respect to Cathode
    - Total DC and Peak ..... 200 Volts
  - Heater Positive with Respect to Cathode
    - DC ..... 100 Volts
    - Total DC and Peak ..... 200 Volts

**DIRECT INTERELECTRODE CAPACITANCES**

- Grid to Plate ..... 0.4 Pf
- Input: g1 to (h + k + g2 + g3) ..... 8.0 Pf
- Output: p to (h + k + g2 + g3) ..... 8.5 Pf

**RATINGS (Design Maximum Rating System)**

**Class A1 Amplifier**

- Plate Voltage (Max.) ..... 275 Volts
- Grid No. 2 Voltage (Max.) ..... 275 Volts
- Plate Dissipation (Max.) ..... 12 Watts
- Grid No. 2 Dissipation (Max.) ..... 2 Watts
- Grid No. 1 Circuit Resistance
  - Fixed Bias (Max.) ..... 0.1 Megohm
  - Cathode Bias (Max.) ..... 0.5 Megohm
- Bulb Temperature (At Any Point) (Max.) ..... 250 °C

**CHARACTERISTICS AND TYPICAL OPERATION**

Plate Voltage .....	180	250 Volts
Grid No. 2 Voltage .....	180	250 Volts
Grid No. 1 Voltage .....	-8.5	-12.5 Volts
Peak AF Grid No. 1 Voltage .....	8.5	12.5 Volts
Zero-Signal Plate Current .....	29	45 Ma
Maximum Signal Plate Current .....	30	47 Ma
Zero-Signal Grid No. 2 Current .....	3	4.5 Ma
Maximum Signal Grid No. 2 Current .....	4	7.0 Ma
Plate Resistance (Approx.) .....	58,000	52,000 Ohms
Transconductance .....	3700	4100 $\mu$ mhos
Load Resistance .....	5500	5000 Ohms
Maximum Signal Power Output .....	2.0	4.5 Watts
Total Harmonic Distortion (Approx.) .....	8	8 Percent

**NOTE:**

(1) The time interval between the instant all electrode voltages are applied and the instant a current of 1 Ma flow in the plate circuit. Ef = 6.3, Eb and Ec2 = 250 V, Rk = 680 Ohms.

*Color Television Type*

**VHF OSCILLATOR and MIXER**

**6HG8/ECF86**

4HG8, 5HG8/LCF86,  
7HG8/PCF86, 8HG8

**Medium Mu Triode and Sharp Cutoff Pentode**

Construction ..... Miniature T-6½  
 Base ..... Button 9 Pin, E9-1  
 Basing ..... 9MP  
 Outline ..... 6-2  
 Maximum Diameter ..... 0.875 In.  
 Maximum Seated Height ..... 1.937 In.  
 Maximum Overall Height ..... 2.187 In.

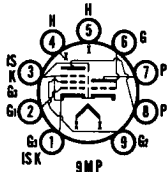

**ELECTRICAL DATA**

**HEATER OPERATION**

	8HG8	7HG8/ PCF86	5HG8/LCF86	4HG8	6HG8/ ECF86
Heater Voltage.....	8.0	7.2	5.3	4.5	6.3 Volts
Heater Current .....	300	300	450	600	340 Ma
Heater Warm-up Time .....	—	—	11	11	— Seconds
Maximum Heater-Cathode Voltage					
Heater Negative with Respect to Cathode					
Total DC and Peak.....					200 Volts
Heater Positive with Respect to Cathode					
DC .....					100 Volts
Total DC and Peak.....					200 Volts

**DIRECT INTERELECTRODE CAPACITANCES (Unshielded)**

**Triode Section**

Grid to Plate .....	2.0 Pf
Input: g to (h + k, Pk, Pg3, IS) .....	2.4 Pf
Output: p to (h + k, Pk, Pg3, IS) .....	1.1 Pf

**Pentode Section**

Grid No. 1 to Plate (Max.).....	0.20 Pf
Input: g1 to (h + k, Tk, g3, IS + g2) .....	6.0 Pf
Output: p to (h + k, Pk, Pg3, IS + g2) .....	3.5 Pf
Grid No. 1 to Grid No. 2 .....	1.7 Pf

**Coupling**

Triode Grid to Pentode Plate (Max.) .....	0.014 Pf
Pentode Grid No. 1 to Triode Plate (Max.) .....	0.01 Pf
Pentode Plate to Triode Plate (Max.) .....	0.14 Pf
Pentode Grid No. 1 to Triode Grid (Max.) .....	0.01 Pf

**RATINGS (Design Maximum Rating System)**

	Triode Section	Pentode Section
Plate Voltage (Max.) .....	125	250 Volts
Grid No. 2 Supply Voltage (Max.) .....	—	250 Volts
Grid No. 2 Voltage .....	See Rating Chart (Gen. Info. Sec.)	
Positive Grid No. 1 Voltage (Max.) .....	0	0 Volt
Plate Dissipation (Max.) .....	1.9	2.2 Watts
Grid No. 2 Dissipation (Max.) .....	—	0.55 Watts
Cathode Current (Max.).....	16.5	20 Ma

Grid No. 1 Circuit Resistance (Max.) .....	0.5	— Megohm
Fixed Bias (Max.) .....	—	0.25 Megohm
Cathode Bias (Max.) .....	—	0.5 Megohm

The spacing between the control grids and cathodes are of such a low order of magnitude as to preclude the use of excessive voltages between these elements in commercial tube checkers and shorts indicating devices, particularly where the tube is mechanically excited. The DC or peak AC voltage applied between each sections control grid and cathode must not exceed 30 volts for the pentode or 50 volts for the triode.

**CHARACTERISTICS AND TYPICAL OPERATION**

	<b>Triode Section</b>	<b>Pentode Section</b>
Plate Voltage .....	100	170 Volts
Grid No. 2 Voltage .....	—	150 Volts
Grid No. 1 Voltage .....	-3	-1.2 Volts
Plate Current .....	14	10 Ma
Grid No. 2 Current .....	—	3.3 Ma
Transconductance .....	5500	12,000 $\mu$ mhos
Amplification Factor ( $g_1$ to $g_2$ ) .....	17	70
Plate Resistance.....	3100	350,000 Ohms

**AVERAGE PLATE CHARACTERISTICS (Pentode Section)**

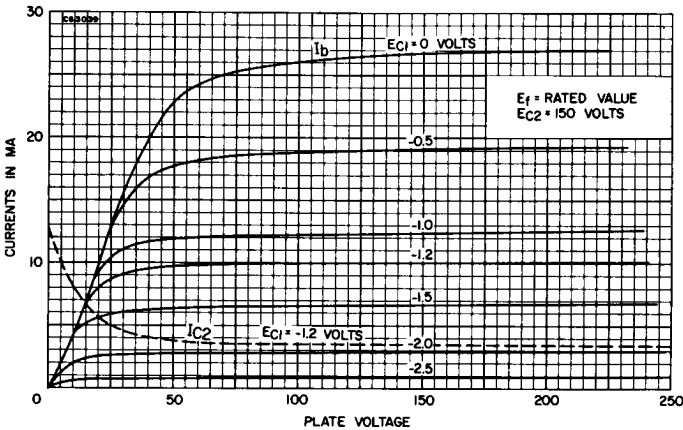

**6HJ5**  
21HJ5, 30HJ5

**HORIZONTAL DEFLECTION AMPLIFIER**

**Beam Power Pentode**

- Construction..... Compactron T-12
- Base .....
- Basing .....
- Outline .....
- Maximum Diameter .....
- Maximum Seated Height .....
- Maximum Overall Height .....

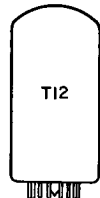
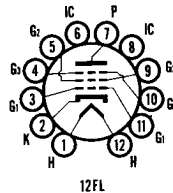

**ELECTRICAL DATA HEATER OPERATION**

	<b>30HJ5</b>	<b>21HJ5</b>	<b>6HJ5</b>
Heater Voltage .....	30	21.5	6.3 Volts
Heater Current .....	450	600	2250 Ma
Heater Warm-up Time .....	11	11	— Seconds
Maximum Heater-Cathode Voltage			
Heater Negative with Respect to Cathode			200 Volts
Total DC and Peak.....			100 Volts
Heater Positive with Respect to Cathode			200 Volts
DC .....			100 Volts
Total DC and Peak.....			200 Volts



**RATINGS (Design Maximum Rating System)**

**Horizontal Deflection Amplifier<sup>(1)</sup>**

Plate Voltage (boost + DC power supply) (Max.) .....	770 Volts
Grid No. 2 Voltage (Max.) .....	220 Volts
Plate Dissipation (Max.) .....	24 Watts
Grid No. 2 Dissipation (Max.) .....	6.0 Watts
Grid No. 2 Dissipation (warm up surge) (Max.) <sup>(2)</sup> .....	12 Watts
Average Cathode Current (Max.) .....	280 Ma
Peak Cathode Current (Max.) .....	1000 Ma
Peak Positive Plate Voltage (Max.) .....	7000 Volts
Peak Negative Plate Voltage (Max.) .....	1500 Volts
Peak Negative Grid No. 1 Voltage (Max.) .....	330 Volts
Grid No. 1 Circuit Resistance (Max.) .....	1.0 Megohm
Bulb Temperature (at Hottest Point) (Max.) .....	240 °C
DC Grid No. 3 Voltage (Max.) .....	70 Volts

**CHARACTERISTICS AND TYPICAL OPERATION**

Plate Voltage .....	20	40	60	135 Volts
Grid No. 2 Voltage .....	110	110	135	135 Volts
Grid No. 1 Voltage .....	0	0	0	-22 Volts
Grid No. 3 Voltage .....	—	—	—	0 Volt
Plate Current .....	240 <sup>(3)</sup>	400 <sup>(3)</sup>	540 <sup>(3)</sup>	80 Ma
Grid No. 2 Current .....	160 <sup>(3)</sup>	42 <sup>(3)</sup>	48 <sup>(3)</sup>	5.5 Ma
Triode Amplification Factor .....	—	—	—	4.2
Transconductance .....	—	—	—	10,000 $\mu$ mhos
Plate Resistance .....	—	—	—	5000 Ohms
Grid No. 1 Voltage (Approx.) for Ib = 1 Ma (Ep = 4.5 KV) .....	—	—	—	-70 Volts

**NOTES:**

- (1) For operating in a 525 line, 30 frame system as described in "Standards of Good Engineering Practice for Television Broadcast Stations, Federal Communications Commission," the duty cycle of the voltage pulse must not exceed 15% of one horizontal scanning cycle.
- (2) Surge not to exceed 15 seconds duration.
- (3) Instantaneous Values.

**DETECTOR or DC RESTORER  
and IF/AGC AMPLIFIER**

**6HJ8**

**High Perveance Diode and Sharp Cutoff Pentode**

Construction .....	Miniature T-6 $\frac{1}{2}$
Base .....	Button 9 Pin, E9-1
Basing .....	.9CY
Outline .....	.6-2
Maximum Diameter .....	.0.875 In.
Maximum Seated Height .....	1.937 In.
Maximum Overall Height .....	2.187 In.

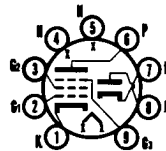

.9CY

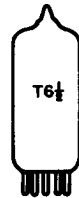

**ELECTRICAL DATA**

**HEATER OPERATION**

Heater Voltage .....	6.3 Volts
Heater Current .....	450 Ma
Heater Warm-up Time .....	11 Seconds
Maximum Heater-Cathode Voltage Heater Negative with Respect to Cathode Total DC and Peak .....	200 Volts
Heater Positive with Respect to Cathode DC .....	100 Volts
Total DC and Peak .....	200 Volts

**DIRECT INTERELECTRODE CAPACITANCES (Shielded)<sup>(1)</sup>**

<b>Pentode</b>	
Grid to Plate (Max.) .....	0.015 Pf
Input: g1 to (h+k+g2+g3+IS) .....	7.0 Pf
Output: p to (h+k+g2+g3+IS) .....	3.2 Pf

**Diode**

Input: p to (h + k) .....	2.4 Pf
Output: k to (h + p) .....	3.0 Pf

**Coupling**

Diode Plate to Pentode Plate (Max.) .....	0.035 Pf
Diode Plate to Grid No. 1 (Max.) .....	0.005 Pf
Diode Cathode to Pentode Plate (Max.) .....	0.015 Pf

**RATINGS (Design Maximum Rating System)**

Plate Voltage (Max.) .....	330 Volts
Grid No. 2 Voltage .....	See Rating Chart (Gen. Info. Sec.)
Grid No. 2 Supply Voltage (Max.) .....	330 Volts
Plate Dissipation (Max.) .....	3.2 Watts
Grid No. 2 Dissipation (Max.) .....	0.55 Watt
Positive Grid No. 1 Voltage (Max.) .....	0 Volt
Grid No. 1 Circuit Resistance	
Cathode Bias (Max.) .....	1.0 Megohm
Fixed Bias (Max.) .....	0.25 Megohm
Diode Current for Continuous Operation (Max.) .....	5.0 Ma

**CHARACTERISTICS AND TYPICAL OPERATION**

Plate Voltage .....	125 Volts
Grid No. 2 Voltage .....	125 Volts
Grid No. 3 Voltage .....	0 Volts
Cathode Resistor .....	56 Ohms
Plate Current .....	11.5 Ma
Grid No. 2 Current .....	3.6 Ma
Transconductance .....	9300 $\mu$ mhos
Plate Resistance (Approx.) .....	0.2 Megohm
Grid No. 1 Voltage for $I_b = 20 \mu$ a (Approx.) .....	-6 Volts
Diode Plate Voltage for Diode Current of 50 Ma <sup>(2)</sup> .....	10 Volts

**NOTES:**

- (1) Shield No. 315.
- (2) Test condition only.

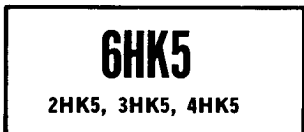

**Gain Controlled Triode**

Construction ..... Miniature T-5½  
 Base ..... Button 7 Pin, E7-1  
 Basing ..... 7GM  
 Outline ..... 5-2  
 Maximum Diameter ..... 0.750 In.  
 Maximum Seated Height ..... 1.875 In.  
 Maximum Overall Height ..... 2.125 In.

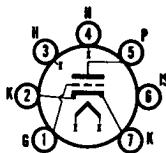

**ELECTRICAL DATA  
 HEATER OPERATION**

	7GM			
	2HK5	3HK5	4HK5	6HK5
Heater Voltage .....	2.3	2.9	4.0	6.3 Volts
Heater Current .....	600	450	300	190 Ma
Heater Warm-up Time .....	11	11	—	— Seconds
Maximum Heater-Cathode Voltage				
Heater Negative with Respect to Cathode				
Total DC and Peak .....				100 Volts
Heater Positive with Respect to Cathode				
Total DC and Peak .....				100 Volts

**DIRECT INTERELECTRODE CAPACITANCES (Shielded)<sup>(1)</sup>**

Grid to Plate .....	0.29 Pf
Input: g to (h + k + IS + E.S.) .....	4.4 Pf
Output: p to (h + k + IS + E.S.) .....	2.6 Pf
Heater to Cathode .....	2.5 Pf

**RATINGS (Design Maximum Rating System)**

Plate Voltage (Max.) .....	200 Volts
Plate Dissipation (Max.) .....	2.3 Watts
DC Cathode Current (Max.) .....	22 Ma
Negative Grid Voltage (Max.) .....	50 Volts
Grid Circuit Resistance (Self Bias) (Max.) .....	1.0 Megohm

Control grid to cathode spacing on this type is of such low order of magnitude as to preclude the use of voltage between these elements of more than 30 volts dc or peak ac in commercial tube checkers and shorts indicating devices, particularly where mechanical excitation of the tube is employed.

**CHARACTERISTICS AND TYPICAL OPERATION**

**Class A1 Amplifier**

Plate Voltage .....	135 Volts
Grid Voltage .....	-1.0 Volt
Plate Current .....	12.5 Ma

Transconductance .....	15,000 $\mu$ mhos
Amplification Factor .....	75
Plate Resistance (Approx.) .....	5000 Ohms
$E_c$ for $G_m = 150 \mu$ mhos (Approx.) .....	-5.0 Volts
$E_c$ for $G_m = 1500 \mu$ mhos (Approx.) .....	-2.6 Volts
Input Resistance (200 MHz) <sup>(3)</sup> .....	600 Ohms
Input Capacitance (200 MHz) <sup>(2)</sup> .....	9.0 Pf
Noise Figure (200 MHz) <sup>(3)</sup> .....	4.2 db

**NOTES:**

- (1) Shield No. 316.
- (2) Measured under grounded plate conditions.
- (3) Optimized neutralized triode RF amplifier stage, noise matched.

*Color Television Type*

**SYNC SEPARATOR or VOLTAGE AMP. (T)  
VIDEO/IF/AGC AMPLIFIER (P)**

**6HL8**

**Medium Mu Triode and Sharp Cutoff Pentode**

Construction .....	Miniature T-6½
Base .....	Button 9 Pin, E9-1
Basing .....	9AE
Outline .....	6-2
Maximum Diameter .....	0.875 In.
Maximum Seated Height .....	1.937 In.
Maximum Overall Height .....	2.187 In.

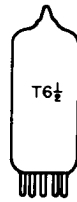
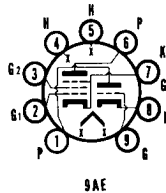

**ELECTRICAL DATA**

**HEATER OPERATION**

Heater Voltage .....	6.3 Volts
Heater Current .....	600 Ma
Heater Warm-up Time .....	11 Seconds
Maximum Heater-Cathode Voltage	
Heater Negative with Respect to Cathode	
Total DC and Peak .....	200 Volts
Heater Positive with Respect to Cathode	
DC .....	100 Volts
Total DC and Peak .....	200 Volts

**DIRECT INTERELECTRODE CAPACITANCES**

**Triode Section**

	Shielded	Unshielded
Grid to Plate .....	2.8	2.8 Pf
Input: g to (h + k + Pk, g3, IS) .....	3.0	2.8 Pf
Output: p to (h + k + Pk, g3, IS) .....	2.4	1.6 Pf

**Pentode Section**

Grid No. 1 to Plate (Max.) .....	0.025	0.03 Pf
Input: g1 to (h + k, g3, IS + g2) .....	7.5	7.5 Pf
Output: p to (h + k, g3, IS + g2) .....	3.0	2.3 Pf

**RATINGS (Design Maximum Rating System)**

	Triode Section	Pentode Section
Plate Voltage (Max.) .....	330	330 Volts
Grid No. 2 Supply Voltage (Max.) .....	—	330 Volts
Grid No. 2 Voltage .....	See Rating Chart (Gen. Info. Sec.)	
Positive Grid No. 1 Voltage (Max.) .....	—	0 Volt
Plate Dissipation (Max.) .....	2.5	2.5 Watts
Grid No. 2 Dissipation (Max.) .....	—	0.55 Watt
Grid No. 1 Circuit Resistance		
Fixed Bias (Max.) .....	1.0	— Megohm
Self Bias (Max.) .....	1.0	— Megohm

**CHARACTERISTICS AND TYPICAL OPERATION**

	Triode Section	Pentode Section
Plate Voltage .....	125	125 Volts
Grid No. 2 Voltage .....	—	125 Volts
Grid No. 1 Voltage .....	-1.0	-1.0 Volt
Transconductance .....	7000	10,000 $\mu$ mhos
Plate Current .....	12.5	12.0 Ma
Grid No. 2 Current .....	—	4.5 Ma
Plate Resistance (Approx.) .....	5000	150,000 Ohms
Amplification Factor .....	40	—
$E_{c1}$ for $I_b = 20 \mu$ a (Approx.) .....	—	-7 Volts

# 6HM6

3HM6, 4HM6

# IF AMPLIFIER

### Sharp Cutoff Pentode

Construction ..... Miniature T-6½  
 Base ..... Button 9 Pin, E9-1  
 Basing ..... 9PM  
 Outline ..... 6-2  
 Maximum Diameter ..... 0.875 In.  
 Maximum Seated Height ..... 1.937 In.  
 Maximum Overall Height ..... 2.187 In.

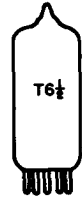
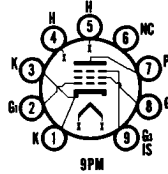

### ELECTRICAL DATA

#### HEATER OPERATION

	3HM6	4HM6	6HM6
Heater Voltage.....	3.15	4.2	6.3 Volts
Heater Current.....	600	450	300 Ma
Heater Warm-up Time.....	11	11	— Seconds
Maximum Heater-Cathode Voltage			
Heater Negative with Respect to Cathode			
Total DC and Peak.....			200 Volts
Heater Positive with Respect to Cathode			
Total DC and Peak.....			200 Volts

#### DIRECT INTERELECTRODE CAPACITANCES

	Shielded	Unshielded
Grid No. 1 to Plate.....	0.024	0.031 Pf
Input.....	8.70	8.70 Pf
Output.....	3.00	2.15 Pf

#### RATINGS (Design Maximum Rating System)

Plate Voltage (Max.).....	250 Volts
Grid No. 2 Voltage (Supply) (Max.).....	250 Volts
Grid No. 2 Voltage.....	See Rating Chart (Gen. Info. Sec.)
Grid No. 1 Voltage (Neg.) (Max.).....	50 Volts
Cathode Current (Max.).....	25 Ma
Plate Dissipation (Max.).....	2.5 Watts
Grid No. 2 Dissipation (Max.).....	0.6 Watt
Grid No. 1 Circuit Resistance	
Cathode Bias (Max.).....	1 Megohm
Fixed Bias (Max.).....	0.25 Megohm

#### CHARACTERISTICS AND TYPICAL OPERATION

Plate Voltage.....	125 Volts
Grid No. 3.....	(Tied to Cathode)
Grid No. 2 Voltage.....	125 Volts
Grid No. 1 Voltage.....	-3.0 Volts
Plate Current.....	13 Ma
Grid No. 2 Current.....	3.2 Ma
Cathode Resistor.....	56 Ohms
Plate Resistance.....	156,000 Ohms
Transconductance.....	15,000 μmhos

# 6HQ5

2HQ5, 3HQ5, 4HQ5

Color Television Type

# VHF AMPLIFIER

### Sharp Cutoff Triode

Construction ..... Miniature T-5½  
 Base ..... Button 7 Pin, E7-1  
 Basing ..... 7GM  
 Outline ..... 5-2  
 Maximum Diameter ..... 0.750 In.  
 Maximum Seated Height ..... 1.875 In.  
 Maximum Overall Height ..... 2.125 In.

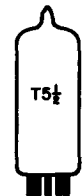
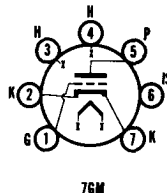

**ELECTRICAL DATA  
HEATER OPERATION**

	2HQ5	3HQ5	4HQ5	6HQ5
Heater Voltage.....	2.4	3.0	4.2	6.3 Volts
Heater Current.....	600	450	300	200 Ma
Heater Warm-up Time.....	11	11	11	— Seconds
Maximum Heater-Cathode Voltage				
Heater Negative with Respect to Cathode				
Total DC and Peak.....	100 Volts			
Heater Positive with Respect to Cathode				
Total DC and Peak.....	100 Volts			

**DIRECT INTERELECTRODE CAPACITANCES (Shielded)**

Grid to Plate.....	0.52 Pf
Input: g to (h + k + IS + E.S.).....	5.0 Pf
Output: p to (h + k + IS + E.S.).....	3.5 Pf
Heater to Cathode.....	2.5 Pf

**RATINGS (Design Maximum Rating System)**

Plate Voltage (Max.).....	200 Volts
Plate Dissipation (Max.).....	2.5 Watts
DC Cathode Current (Max.).....	22 Ma
Negative Grid Voltage (Max.).....	50 Volts
Grid Circuit Resistance (Self Bias) (Max.).....	1.0 Megohm

**CHARACTERISTICS AND TYPICAL OPERATION**

**Class A1 Amplifier**

Plate Voltage.....	135 Volts
Grid Voltage.....	-1.0 Volt
Plate Current.....	11.5 Ma
Transconductance.....	15,000 $\mu$ mhos
Amplification Factor.....	78
Plate Resistance (Approx.).....	5400 Ohms
Ec for Gm = 150 $\mu$ mhos (Approx.).....	-4.2 Volts
Ec for Gm = 1500 $\mu$ mhos (Approx.).....	-2.5 Volts
Input Resistance (200 MHz) <sup>(1)</sup> .....	275 Ohms
Input Capacitance (200 MHz) <sup>(1)</sup> .....	11.2 Pf
Noise Figure (200 MHz) <sup>(2)</sup> .....	4.7 db

**NOTES:**

- (1) Measured under grounded plate conditions.
- (2) Optimized neutralized triode RF amplifier stage, noise matched.

**AVERAGE PLATE CHARACTERISTICS**

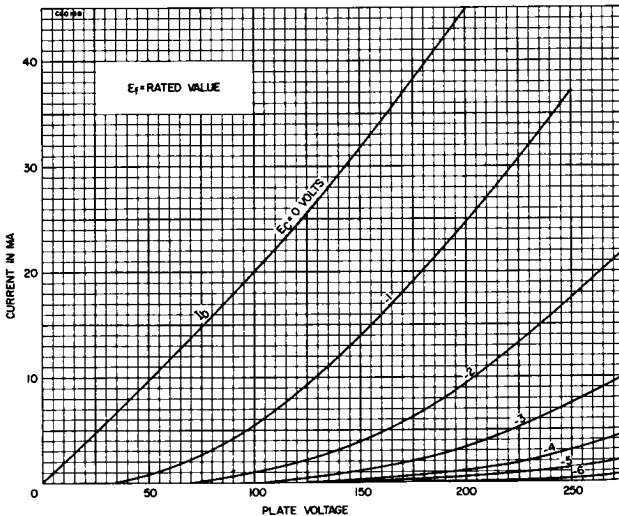

**AVERAGE TRANSFER CHARACTERISTICS**

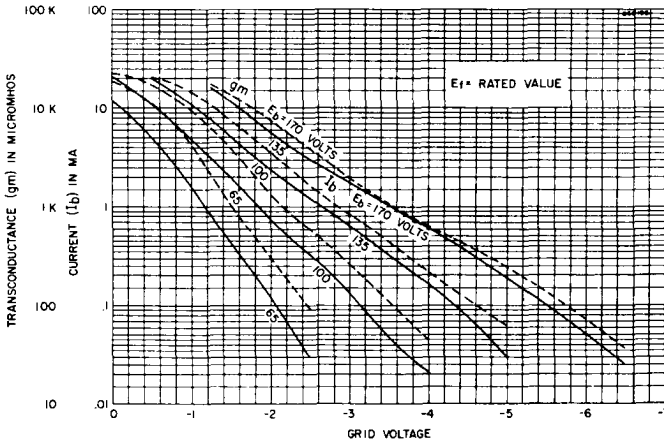

**6HR5**

**VERTICAL DEFLECTION AMPLIFIER**

**Beam Power Pentode**

- Construction ..... Miniature T-5½
- Base ..... Button 7 Pin, E7-1
- Basing ..... 7BZ
- Outline ..... 5-3
- Maximum Diameter ..... 0.750 In.
- Maximum Seated Height ..... 2.375 In.
- Maximum Overall Height ..... 2.625 In.

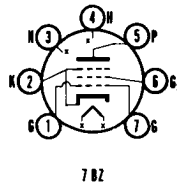

**ELECTRICAL DATA**

**HEATER OPERATION**

- Heater Voltage ..... 6.3 Volts
- Heater Current ..... 450 Ma
- Heater Warm-up Time ..... 11 Seconds
- Maximum Heater-Cathode Voltage
- Heater Negative with Respect to Cathode
- Total DC and Peak ..... 200 Volts
- Heater Positive with Respect to Cathode
- DC ..... 100 Volts
- Total DC and Peak ..... 200 Volts

**DIRECT INTERELECTRODE CAPACITANCES (Unshielded)**

- Grid 1 to Plate ..... 0.35 Pf
- Input ..... 8.3 Pf
- Output ..... 8.2 Pf

**RATINGS (Design Maximum Rating System)**

**Vertical Deflection Amplifier<sup>(3)</sup>**

- Plate Voltage (Max.) ..... 260 Volts
- Peak Positive Pulse Plate Voltage (Abs. Max.) ..... 1500 Volts
- Grid 2 Voltage (Max.) ..... 270 Volts
- Peak Negative Pulse Grid 1 Voltage (Max.) ..... 150 Volts
- Plate Dissipation (Max.) ..... 8 Watts
- Grid 2 Dissipation (Max.) ..... 2 Watts
- Cathode Current:
- Average (Max.) ..... 35 Ma
- Peak (Max.) ..... 125 Ma
- Grid 1 Circuit Resistance (Max.) ..... 2.2 Megohms

**CHARACTERISTICS AND TYPICAL OPERATION**

- Plate Voltage ..... 50 ..... 260 Volts
- Grid 2 (Screen) Voltage ..... 250 ..... 270 Volts
- Grid 1 Voltage ..... 0<sup>(1)</sup> ..... -19 Volts
- Transconductance ..... — ..... 3600 μmhos
- Plate Current ..... 105 ..... 30 Ma

Grid 2 Current .....	25	2.3 Ma
Grid 1 Cutoff Voltage <sup>(2)</sup> .....	—	-43 Volts

**NOTES:**

- (1) Applied for short interval (maximum of 2 seconds) so as not to damage tube.
- (2) For plate current of 100  $\mu$ a.
- (3) For operation in a 525 line, 30 frame system as described in "Standards of Good Engineering Practice for Television Broadcast Stations; Federal Communications Commission," the duty cycle of the voltage pulse must not exceed 15% of one horizontal scanning cycle.

**IF AMPLIFIER**

**6HR6**  
19HR6

**Semi-Remote-Cutoff Pentode**

Construction ..... Miniature T-5½  
 Base ..... Button 7 Pin, E7-1  
 Basing ..... 7BK  
 Outline ..... 5-2  
 Maximum Diameter ..... 0.750 In.  
 Maximum Seated Height ..... 1.875 In.  
 Maximum Overall Height ..... 2.125 In.

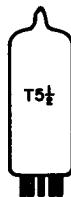
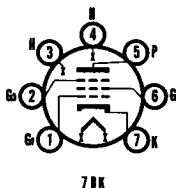

**ELECTRICAL DATA**

**HEATER OPERATION**

	19HR6	6HR6
Heater Voltage.....	18.9	6.3 Volts
Heater Current .....	150	450 Ma
Heater Warm-up Time .....	17	11 Seconds
Maximum Heater-Cathode Voltage		
Heater Negative with Respect to Cathode		
Total DC and Peak.....		200 Volts
Heater Positive with Respect to Cathode		
DC .....		100 Volts
Total DC and Peak.....		200 Volts

**DIRECT INTERELECTRODE CAPACITANCES (Unshielded)**

Grid No. 1 to Plate (Max.) .....	0.006 Pf
Grid No. 1 to Cathode, Grid No. 3 and Internal Shield, Grid No. 2, and Heater .....	8.8 Pf
Plate to Cathode, Grid No. 3 and Internal Shield, Grid No. 2, and Heater .....	5.2 Pf

**RATINGS (Design Maximum Rating System)**

**Class A1 Amplifier**

Plate Supply Voltage (Max.) .....	300 Volts
Grid No. 3 (Suppressor-Grid).....	Connect to Cathode at Socket
Grid No. 2 (Screen-Grid) Supply Voltage (Max.) .....	300 Volts
Grid No. 2 Voltage .....	See Rating Chart (Gen. Info. Sec.)
Grid No. 1 (Control-Grid) Voltage:	
Positive Bias Value (Max.) .....	0 Volt
Negative Bias Value (Max.) .....	50 Volts
Plate Dissipation (Max.) .....	3 Watts
Grid No. 2 Input:	
For Grid No. 2 Voltages up to 150 Volts (Max.) .....	1 Watt
For Grid No. 2 Voltages between 150 and 300 Volts .....	See Rating Chart (Gen. Info. Sec.)

**Maximum Circuit Values:**

Grid No. 1 Circuit Resistance:	
For Fixed Bias Operation (Max.) .....	0.5 Megohm
For Cathode Bias Operation (Max.) .....	1 Megohm

**CHARACTERISTICS AND TYPICAL OPERATION**

**Class A1 Amplifier**

Plate Supply Voltage.....	200 Volts
Grid No. 3 .....	Connected to Cathode at Socket
Grid No. 2 Supply Voltage.....	115 Volts
Grid No. 1 Supply Voltage.....	0 Volt
Cathode Resistor .....	68 Ohms
Plate Resistance (Approx.) .....	0.5 Megohm
Transconductance .....	8500 $\mu$ mhos
Plate Current .....	13.2 Ma
Grid No. 2 Current .....	4.3 Ma
Grid No. 1 Voltage (Approx.) for Transconductance = 60 $\mu$ mhos .....	-15 Volts

# 6HS5

# HIGH VOLTAGE REGULATOR

### Beam Triode

Construction.....Compactron T-12  
 Base .....Button 12 Pin, E12-74  
 Basing .....12GY  
 Outline .....12-60  
 Maximum Diameter .....1.563 In.  
 Maximum Seated Height .....3.500 In.  
 Maximum Overall Height .....3.875 In.

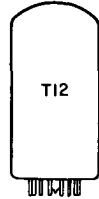
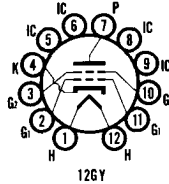

### ELECTRICAL DATA

#### HEATER OPERATION

Heater Voltage.....	6.3 Volts
Heater Current .....	1500 Ma
Maximum Heater-Cathode Voltage	
Heater Negative with Respect to Cathode	
Total DC and Peak.....	450 Volts
Heater Positive with Respect to Cathode	
DC .....	100 Volts
Total DC and Peak.....	200 Volts

#### DIRECT INTERELECTRODE CAPACITANCES (Unshielded)

Grid to Plate .....	1.6 Pf
Input: g to (h + k + bp) .....	24 Pf
Output: p to (h + k + bp) .....	6.5 Pf

#### RATINGS (Design Maximum Rating System)

##### High-Voltage Regulator Service<sup>(1)</sup>

Peak Plate Voltage.....	5500 Volts
Plate Dissipation .....	30 Watts
Peak Plate Current .....	325 Ma
Grid-Circuit Resistance <sup>(2)</sup> .....	0.1 Megohm
Bulb Temperature at Hottest Point .....	220 °C

#### CHARACTERISTICS AND TYPICAL OPERATION

Pulse Plate Voltage <sup>(3)</sup> .....	3500 Volts
Beam Plate Connected to Cathode at Socket	
Negative DC Grid Voltage .....	4.4 Volts
Peak Plate Current .....	300 Ma
Amplification Factor .....	300
Transconductance .....	65,000 $\mu$ mhos
Plate Resistance, (Approx.) .....	4600 Ohms
Grid Voltage, (Approx.) .....	
Eb = 3500 Volts, Ib = 1.0 Ma .....	-13 Volts

#### NOTES:

- (1) For operation in a 525 line, 30 frame system as described in "Standards of Good Engineering Practice for Television Broadcast Stations; Federal Communications Commission," the duty cycle of the voltage pulse must not exceed 15% of one horizontal scanning cycle.
- (2) Larger values of grid-circuit resistance may be used if provisions are made to protect the tube.
- (3) Duty cycle of the pulse must be less than 2.5%.

# 6HS6

19HS6

# IF AMPLIFIER

### Sharp Cutoff Pentode

Construction .....Miniature T-5 $\frac{1}{2}$   
 Base .....Button 7 Pin, E7-1  
 Basing .....7BK  
 Outline .....5-2  
 Maximum Diameter .....0.750 In.  
 Maximum Seated Height .....1.875 In.  
 Maximum Overall Height .....2.125 In.

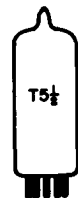
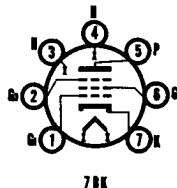



**ELECTRICAL DATA**

**HEATER OPERATION**

	<b>19HS6</b>	<b>6HS6</b>
Heater Voltage.....	18.9	6.3 Volts
Heater Current .....	150	450 Ma
Heater Warm-up Time .....	17	11 Seconds
<b>Maximum Heater-Cathode Voltage</b>		
Heater Negative with Respect to Cathode		
Total DC and Peak.....		200 Volts
Heater Positive with Respect to Cathode		
DC .....		100 Volts
Total DC and Peak.....		200 Volts

**DIRECT INTERELECTRODE CAPACITANCE (Unshielded)**

Grid No. 1 to Plate (Max.).....	0.006 Pf
Grid No. 1 to Cathode, Grid No. 3 and Internal Shield,	
Grid No. 2, and Heater .....	8.8 Pf
Plate to Cathode, Grid No. 3 and Internal Shield,	
Grid No. 2, and Heater .....	5.2 Pf

**RATINGS (Design Maximum Rating System)**

**Class A1 Amplifier**

Plate Supply Voltage (Max.) .....	300 Volts
Grid No. 3 (Suppressor Grid).....	Connect to Cathode at Socket
Grid No. 2 (Screen Grid) Supply Voltage (Max.) .....	300 Volts
Grid No. 2 Voltage .....	See Rating Chart (Gen. Info. Sec.)
Grid No. 1 (Control Grid) Voltage:	
Positive Bias Value (Max.) .....	0 Volts
Negative Bias Value (Max.) .....	50 Volts
Plate Dissipation (Max.) .....	3 Watts
Grid No. 2 Input:	
For Grid No. 2 Voltages up to 150 Volts (Max.) .....	1 Watt
For Grid No. 2 Voltages Between 150	
and 300 Volts .....	See Rating Chart (Gen. Info. Sec.)
<b>Maximum Circuit Values:</b>	
Grid No. 1 Circuit Resistance:	
For Fixed Bias Operation (Max.) .....	0.5 Megohm
For Cathode Bias Operation (Max.) .....	1 Megohm

**CHARACTERISTICS AND TYPICAL OPERATION**

**Class A1 Amplifier**

Plate Supply Voltage.....	75	150 Volts
Grid No. 3 .....	Connected to	Cathode at Socket
Grid No. 2 Supply Voltage.....	75	75 Volts
Grid No. 1 Supply Voltage.....	0	0 Volts
Cathode Resistor .....	68	68 Ohms
Amplification Factor .....	50	—
Plate Resistance (Approx.) .....	—	0.5 Megohm
Transconductance .....	—	9500 $\mu$ mhos
Plate Current .....	—	8.8 Ma
Grid No. 2 Current .....	—	2.8 Ma
Grid No. 1 Voltage (Approx.) for Plate Current of 20 $\mu$ a .....	—	-4 Volts

Color Television Type

**SYNC SEPARATOR/CLIPPER  
and AGC**

**6HS8**

3HS8, 4HS8

**Double Pentode**

Construction .....	Miniature T-6½
Base .....	Button 9 Pin, E9-1
Basing .....	.9FG
Outline .....	6-3
Maximum Diameter .....	0.875 In.
Maximum Seated Height .....	2.375 In.
Maximum Overall Height .....	2.625 In.

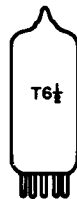
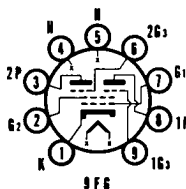

**ELECTRICAL DATA**

**HEATER OPERATION**

	<b>3HS8</b>	<b>4HS8</b>	<b>6HS8</b>
Heater Voltage.....	3.15	4.2	6.3 Volts
Heater Current .....	600	450	300 Ma
Heater Warm-up Time .....	11	11	— Seconds

Maximum Heater-Cathode Voltage	
Heater Negative with Respect to Cathode	
Total DC and Peak.....	200 Volts
Heater Positive with Respect to Cathode	
DC .....	100 Volts
Total DC and Peak.....	200 Volts

**DIRECT INTERELECTRODE CAPACITANCES (Unshielded)**

Grid No. 3 to Plate (Each Section) .....	2.0 Pf
Grid No. 1 to All.....	6.0 Pf
Grid No. 3 (Each Section) to All .....	3.6 Pf
Plate (Each Section) to All .....	3.0 Pf
Grid No. 3 (Section 1) to Grid No. 3 (Section 2) (Max.) .....	0.015 Pf

**RATINGS (Design Maximum Rating System)**

Plate Voltage (Each Section) (Max.) .....	300 Volts
Grid No. 2 Voltage (Max.) .....	150 Volts
Positive DC Grid No. 3 Voltage (Each Section) (Max.) .....	3.0 Volts
Negative DC Grid No. 3 Voltage (Each Section) (Max.) .....	50 Volts
Peak Positive Grid No. 3 Voltage (Each Section) (Max.) .....	50 Volts
Negative DC Grid No. 1 Voltage (Max.) .....	50 Volts
Plate Dissipation (Each Section) (Max.) .....	1.1 Watts
Grid No. 2 Dissipation (Max.) .....	0.75 Watt
DC Cathode Current (Max.) .....	12 Ma
Grid No. 1 Circuit Resistance (Max.) .....	0.5 Megohm
Grid No. 3 Circuit Resistance (Each Section) (Max.) .....	0.5 Megohm

**CHARACTERISTICS AND TYPICAL OPERATION**

**Both Sections Operating**

Plate Voltage (Each Section) .....	100	100 Volts
Grid No. 2 Voltage .....	67.5	67.5 Volts
Grid No. 3 Voltage (Each Section) .....	-10	0 Volts
Grid No. 1 Voltage .....	Note 1	Note 1
Plate Current (Each Section) .....	—	2.0 Ma
Grid No. 2 Current .....	7.0	4.4 Ma
Cathode Current .....	7.1	8.5 Ma

**Each Section Operating Separately with Plate and Grid No. 3 of Opposite Section Grounded**

Plate Voltage .....	100	100 Volts
Grid No. 2 Voltage .....	67.5	67.5
Grid No. 3 Voltage .....	0	0 Volt
Grid No. 1 Voltage .....	0	— Volt
Plate Current .....	—	2.0 Ma
Grid No. 3 Transconductance .....	—	450 $\mu$ mhos
Grid No. 1 Transconductance .....	1100	— $\mu$ mhos
Ec3 for Ib = 100 $\mu$ a (Approx.) .....	—	-3.5 Volts
Ec1 for Ib = 100 $\mu$ a (Approx.) .....	—	-2.3 Volts

**NOTE:**

(1) Grid current adjusted for 100  $\mu$ a dc.

**AVERAGE PLATE CHARACTERISTICS**

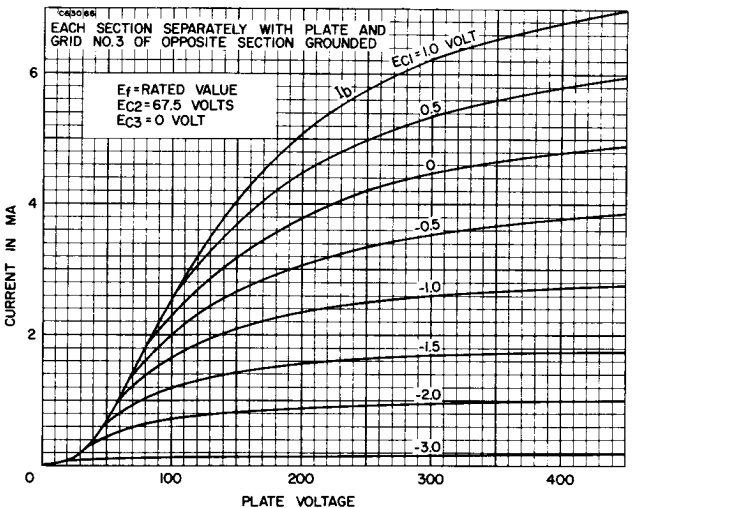

**AVERAGE SCREEN CHARACTERISTICS**

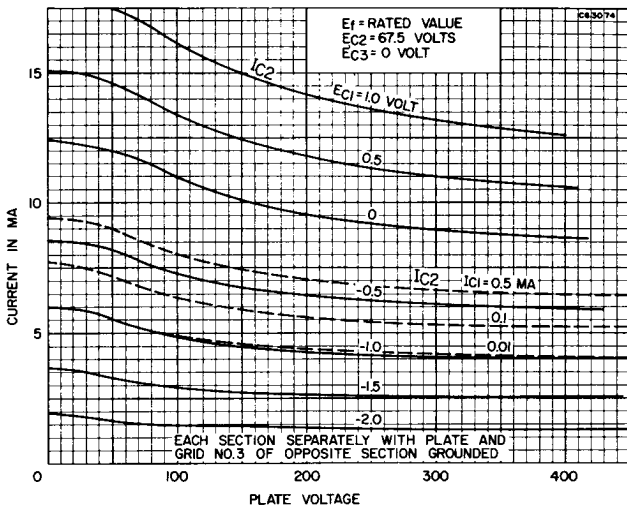

**IF AMPLIFIER**

**6HT6**

3HT6, 4HT6

**Semi-remote Cutoff Pentode**

- Construction ..... Miniature T-6½
- Base ..... Button 9 Pin, E9-1
- Basing ..... 9PM
- Outline ..... 6-2
- Maximum Diameter ..... 0.875 In.
- Maximum Seated Height ..... 1.937 In.
- Maximum Overall Height ..... 2.187 In.

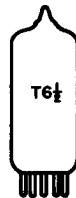
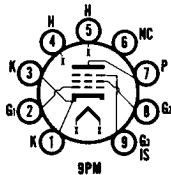

**ELECTRICAL DATA**  
**HEATER OPERATION**

	3HT6	4HT6	6HT6
Heater Voltage.....	3.15	4.2	6.3 Volts
Heater Current .....	600	450	300 Ma
Heater Warm-up Time .....	11	11	— Seconds
Maximum Heater-Cathode Voltage			
Heater Negative with Respect to Cathode			
Total DC and Peak.....			200 Volts
Heater Positive with Respect to Cathode			
DC .....			100 Volts
Total DC and Peak.....			200 Volts

**DIRECT INTERELECTRODE CAPACITANCES**

	Shielded <sup>(1)</sup>	Unshielded
Grid 1 to Plate .....	0.024	0.031 Pf
Input .....	8.70	8.70 Pf
Output .....	3.00	2.15 Pf

**RATINGS (Design Maximum Rating System)**

Plate Voltage (Max.) .....	250 Volts
Grid 2 Supply Voltage (Max.) .....	250 Volts
Grid 2 Voltage .....	See Rating Chart (Gen. Info. Sec.)
Plate Dissipation (Max.) .....	2.5 Watts
Grid 2 Dissipation (Max.) .....	0.6 Watts
Grid 1 Negative Voltage (Max.) .....	50 Volts
Cathode Current (Max.) .....	25 Ma
Grid 1 Circuit Resistance:	
Cathode Resistor Bias (Max.) .....	1 Megohm
Fixed Bias (Max.) .....	0.25 Megohm

**CHARACTERISTICS AND TYPICAL OPERATION**

Plate Voltage .....	125 Volts
Grid 3 (Suppressor) .....	Connected to Cathode at Socket
Grid 2 Voltage .....	125 Volts
Cathode Bias Resistor .....	56 Ohms
Plate Resistance .....	0.143 Megohm
Transconductance .....	14,000 $\mu$ mhos
Plate Current .....	15 Ma
Grid 2 Current .....	4.0 Ma
Grid 1 Cutoff Bias <sup>(2)</sup> .....	-6.7 Volts
Cutoff Transconductance:	
For Grid 1 Volts = -1.5 .....	12,000 $\mu$ mhos
For Grid 1 Volts = -3.5 .....	300 $\mu$ mhos
For Grid 1 Volts = -4.5 .....	100 $\mu$ mhos
Hot Input Resistance <sup>(3)</sup> .....	12,700 Ohms
Hot Input Capacitance <sup>(3)</sup> .....	7.45 Pf

**NOTES:**

- (1) With JEDEC Shield No. 315 connected to ground.
- (2) For transconductance of 50  $\mu$ mhos.
- (3) Measured at 44 MHz with unbypassed 56 Ohm cathode resistance.

<h1 style="margin: 0;">6HU8/ELL80</h1> <p style="margin: 0;">12HU8/PLL80</p>	<h2 style="margin: 0;">AF AMPLIFIER</h2>
--	--

**Double Pentode**

Construction .....	T-6½
Base .....	E9-1
Basing .....	9NJ
Outline .....	6-4
Maximum Diameter .....	0.875 In.
Maximum Seated Height .....	2.812 In.
Maximum Overall Height .....	3.062 In.

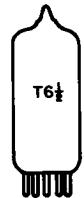
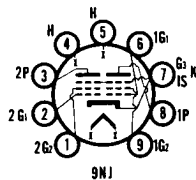

**ELECTRICAL DATA**

**HEATER OPERATION**

	6HU8/ELL80	12HU8/PLL80
Heater Voltage .....	6.3	12 Volts
Heater Current .....	550	300 Ma

**DIRECT INTERELECTRODE CAPACITANCES (Unshielded)**

	Section 1	Section 2
Grid to Plate .....	0.20	1.5 pf
Input: g to (h + g <sub>2</sub> + g <sub>3</sub> + 1S) .....	7.0	7.0 pf
Output: p to (h + k + g <sub>2</sub> + g <sub>3</sub> + 1S) .....	4.5	4.5 pf

**RATINGS (Design Maximum Values) Each Section**

Plate Voltage (Max.) .....	300 Volts
Plate Dissipation (Max.) .....	6 Watts
Positive Grid No. 1 Voltage (Max.) .....	0 Volts
Negative Grid No. 1 Voltage (Max.) .....	100 Volts

**CHARACTERISTICS AND TYPICAL OPERATION**

**Power Amplifier Section**

Plate Voltage .....	250 Volts
Grid No. 2 Voltage .....	250 Volts
Plate Current .....	26 Ma
Transconductance .....	6000 $\mu$ mhos
Amplification Factor .....	100
Load Resistance .....	10,000 Ohms
Power Output .....	3 Watts

**Class B Amplifier—Push-Pull**

Plate Voltage .....	250 Volts
Grid No. 2 Voltage .....	250 Volts
Plate Current (Zero Signal) .....	11 Ma
Total Distortion .....	5 Percent
Load Resistance .....	10,000 Ohms

Color Television Type  
**FM DETECTOR**

**6HZ6**  
5HZ6

**Sharp Cutoff Pentode**

Construction ..... Miniature T-5½  
 Base ..... Button 7 Pin, E7-1  
 Basing ..... 7EN  
 Outline ..... 5-2  
 Maximum Diameter ..... 0.750 In.  
 Maximum Seated Height ..... 1.875 In.  
 Maximum Overall Height ..... 2.125 In.

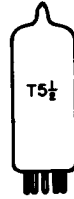
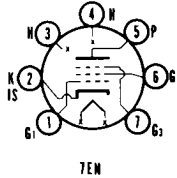

**ELECTRICAL DATA**

**HEATER OPERATION**

	5HZ6	6HZ6
Heater Voltage.....	4.75	6.3 Volts
Heater Current .....	600	450 Ma
Heater Warm-up Time .....	11	11 Seconds
Maximum Heater-Cathode Voltage		
Heater Negative with Respect to Cathode		
Total DC and Peak.....		200 Volts
Heater Positive with Respect to Cathode		
DC .....		100 Volts
Total DC and Peak.....		200 Volts

**DIRECT INTERELECTRODE CAPACITANCES (Unshielded)**

Grid No. 1 to Plate (Max.) .....	0.023 Pf
Grid No. 3 to Plate .....	1.6 Pf
Input: g1 to (h + k + g2 + g3 + IS) .....	8.2 Pf
Input: g3 to (h + k + g1 + g2 + p + IS).....	7.2 Pf
Grid No. 1 to Grid No. 3 .....	0.09 Pf

**RATINGS (Design Maximum Rating System)**

Plate Voltage (Max.) .....	300 Volts
Positive Grid No. 3 Voltage (DC and Peak) (Max.) .....	25 Volts
Negative Grid No. 3 Voltage (DC and Peak) (Max.).....	100 Volts
Grid No. 2 Supply Voltage (Max.) .....	300 Volts
Grid No. 2 Voltage .....	See Rating Chart (Gen. Info. Sec.)
Positive Grid No. 1 Voltage (Max.) .....	0 Volt
Negative Grid No. 1 Voltage (Max.) .....	50 Volts
Plate Dissipation (Max.) .....	1.7 Watts
Grid No. 3 Input (Max.) .....	0.1 Watt
Grid No. 2 Input (Ec2 up to 150 V) (Max.).....	1.0 Watt
Grid No. 2 Input (Ec2 Between 150 V to 300 V) .....	See Rating Chart (Gen. Info. Sec.)
Grid No. 3 Circuit Resistance (Max.) .....	0.68 Megohm
Grid No. 1 Circuit Resistance	
Fixed Bias (Max.) .....	0.22 Megohm
Self Bias (Max.) .....	0.47 Megohm

**CHARACTERISTICS AND TYPICAL OPERATION**

**Class A1 Amplifier**

Plate Voltage .....	150 Volts
Grid No. 3 Voltage .....	0 Volt
Grid No. 2 Voltage .....	100 Volts
Cathode Resistor .....	180 Ohms
Plate Current .....	3.2 Ma
Grid No. 2 Current .....	3.2 Ma
Grid No. 1 Transconductance .....	3400 μmhos
Grid No. 3 Transconductance .....	600 μmhos
Plate Resistance (Approx.) .....	0.11 Megohm
Ec1 for Ib = 20 μa (Approx.).....	-4.5 Volts
Ec3 for Ib = 20 μa (Approx.).....	-7 Volts

**6HZ8****SYNC/VOLTAGE AMPLIFIER (T)  
VIDEO AMPLIFIER (P)****High Mu Triode and  
Sharp Cutoff Pentode**

Construction .....	9T-9
Base .....	Button 9 Pin
Basing .....	9DX
Outline	
Maximum Diameter .....	1.188 In.
Maximum Seated Height .....	2.770 In.
Maximum Overall Height .....	3.080 In.

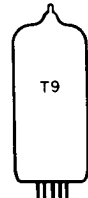
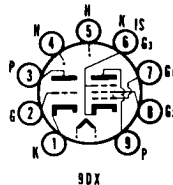
**ELECTRICAL DATA****HEATER OPERATION**

Heater Voltage .....	6.3 Volts
Heater Current .....	1125 Ma
Maximum Heater-Cathode Voltage	
Heater Negative with Respect to Cathode	
Total DC and Peak .....	200 Volts
Heater Positive with Respect to Cathode	
DC .....	100 Volts
Total DC and Peak .....	200 Volts

**DIRECT INTERELECTRODE CAPACITANCES (Unshielded)****Triode Section**

Grid to Plate .....	5.0 Pf
Input: g to (h + Tk) .....	3.8 Pf
Output: p to (h + Tk) .....	0.4 Pf

**Pentode Section**

Grid No. 1 to Plate (Max.) .....	0.1 Pf
Input: g1 to (h + Pk, g3, IS + g2) .....	12 Pf
Output: p to (h + Pk, g3, IS + g2) .....	5.0 Pf

**Coupling**

Pentode Grid No. 1 to Triode Plate (Max.) .....	0.005 Pf
Triode Grid to Pentode Plate (Max.) .....	0.04 Pf
Pentode Plate to Triode Plate (Max.) .....	0.20 Pf

**RATINGS (Design Maximum Rating System)**

	Triode Section	Pentode Section
Plate Voltage (Max.) .....	300	330 Volts
Grid No. 2 Voltage .....	—	330 Volts
Grid No. 2 Supply Voltage (Max.) .....	See Rating Chart (Gen. Info. Sec.)	
Plate Dissipation (Max.) .....	1.0	8.0 Watts
Grid No. 2 Dissipation (Max.) .....	—	2.0 Watts
Positive Grid No. 1 Voltage (Max.) .....	0	0 Volt
Grid Circuit Resistance		
Self Bias (Max.) .....	1.0	1.0 Megohm
Fixed Bias (Max.) .....	0.5	0.25 Megohm

**CHARACTERISTICS AND TYPICAL OPERATION**

	Triode Section	Pentode Section
Plate Voltage .....	200	250 Volts
Grid No. 2 Voltage .....	—	170 Volts
Grid No. 1 Voltage .....	-2	— Volts
Cathode Resistor .....	—	100 Ohms
Plate Current .....	3.5	29 Ma
Grid No. 2 Current .....	—	6 Ma
Transconductance .....	4000	12,600 $\mu$ mhos
Amplification Factor .....	70	—
Plate Resistance (Approx.) .....	—	14,000 Ohms
Ec for Ib = 10 $\mu$ a (Approx.) .....	-5.0	-11.5 Volts

**INSTANTANEOUS PLATE KNEE VALUES (Pentode Section)**

Eb = 60 V; Ec2 = 170 V; and Ec1 = 0 V  
Ib = 90 Ma (Approx.) and Ic2 = 22.5 Ma (Approx.)

Color Television Type

**HIGH FREQUENCY OSCILLATOR,  
AMPLIFIER or MIXER**

**6J6A**

5J6, 19J6

**Double Triode**

Construction ..... Miniature T-5½  
 Base ..... Button 7 Pin, E7-1  
 Basing ..... 7BF  
 Outline ..... 5-2  
 Maximum Diameter ..... 0.750 In.  
 Maximum Seated Height ..... 1.875 In.  
 Maximum Overall Height ..... 2.125 In.

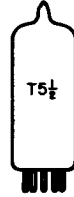
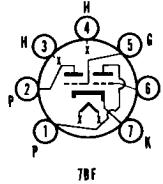

**ELECTRICAL DATA**

**HEATER OPERATION**

	19J6	5J6	6J6A
Heater Voltage.....	18.9	4.7	6.3 Volts
Heater Current .....	150	600	450 Ma
Heater Warm-up Time .....	—	11	11 Seconds
Maximum Heater-Cathode Voltage			
Heater Negative with Respect to Cathode			
Total DC and Peak.....			100 Volts
Heater Positive with Respect to Cathode			
Total DC and Peak.....			100 Volts

**DIRECT INTERELECTRODE CAPACITANCES (Unshielded)**

Grid to Plate .....	1.6 Pf
Grid to Cathode .....	2.2 Pf
Plate to Cathode .....	0.4 Pf

**RATINGS (Design Center Rating System) (Each Section)**

Plate Voltage (Max.) .....	300 Volts
Plate Dissipation (Max.) .....	1.5 Watts
Plate Current (Max.) .....	15 Ma
Grid Voltage (Max.) .....	-40 Volts
Grid Current (Max.) .....	8.0 Ma

**CHARACTERISTICS AND TYPICAL OPERATION (Each Section)**

**Class A1 Amplifier**

Plate Voltage .....	100 Volts
Self Bias Resistor <sup>(1,2)</sup> .....	50 Ohms
Plate Current .....	8.5 Ma
Transconductance .....	5300 μmhos
Amplification Factor .....	38
Plate Resistance .....	7100 Ohms

**Class C Oscillator or RF Amplifier (Push-Pull)**

Plate Voltage .....	150 Volts
Grid Voltage <sup>(3)</sup> .....	-10 Volts
Plate Current .....	30 Ma
Grid Current .....	16 Ma
Driving Power.....	0.35 Watt
Power Output .....	3.5 Watts

**Mixer Service**

Plate Voltage .....	150 Volts
Cathode Bias Resistor <sup>(2)</sup> .....	820 Ohms
Oscillator Peak Voltage .....	3 Volts
Plate Current .....	4.8 Ma
Plate Resistance.....	10,000 Ohms
Conversion Transconductance .....	1900 μmhos

**NOTES:**

- (1) Value is for both sections operating as specified.
- (2) Under rated maximum conditions, total grid circuit resistance should not exceed 0.5 megohm. Fixed bias operation is not recommended.
- (3) Obtained by a grid resistor of 625 ohms or a cathode resistor of 220 ohms.

**6J9**

**VHF AMPLIFIER, OSCILLATOR  
and MIXER**

**Triple Triode**

Construction ..... Miniature T-6½  
 Base ..... Button 10 Pin, E10-73  
 (Center Pin Added to 9 Pin Base)  
 Basing<sup>(1)</sup> ..... 10G  
 Outline ..... 6-13  
 Maximum Diameter ..... 0.875 In.  
 Maximum Seated Height ..... 1.940 In.  
 Maximum Overall Height ..... 2.190 In.

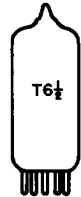
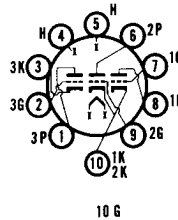

**ELECTRICAL DATA**

**HEATER OPERATION**

Heater Voltage.....	6.3 Volts
Heater Current .....	450 Ma
Heater Warm-up Time .....	11 Seconds
Maximum Heater-Cathode Voltage	
Heater Negative with Respect to Cathode	
Total DC and Peak.....	100 Volts
Heater Positive with Respect to Cathode	
Total DC and Peak.....	100 Volts

**DIRECT INTERELECTRO CAPACITANCES**

	Shielded <sup>(2)</sup>	Unshielded
Grid to Plate (Section 1 and 3) .....	1.6	1.6 Pf
Grid to Plate (Section 2) .....	1.5	1.5 Pf
Input (Each Section) .....	2.6	2.4 Pf
Output (Section No. 1) .....	1.1	0.28 Pf
Output (Section No. 2) .....	1.5	0.44 Pf
Output (Section No. 3) .....	1.1	0.26 Pf
Heater to Cathode (Section No. 3) .....	3.2	3.2 Pf
Heater to Cathode (Sections 1 and 2) .....	6.2	6.2 Pf

**RATINGS (Design Maximum Rating System) (Each Section)**

Plate Voltage (Max.) .....	330 Volts
Plate Dissipation (Each Plate) (Max.) .....	2.0 Watts
Plate Dissipation (Plates 1, 2, and 3) (Max.) .....	5.0 Watts
Positive Grid Voltage (Max.) .....	0 Volt
Negative Grid Voltage (Max.) .....	50 Volts

**CHARACTERISTICS AND TYPICAL OPERATION**

**Class A1 Amplifier (Each Section)**

Plate Voltage .....	125 Volts
Grid Voltage .....	-1.0 Volts
Plate Current .....	6.0 Ma
Plate Resistance.....	11,000 Ohms
Transconductance .....	5200 μmhos
Amplification Factor .....	57
Ec for Ib = 20 μa (Approx.) .....	-5.4 Volts

**NOTES:**

- (1) Section No. 1 connects to Pins 7, 8, and 10; Section No. 2 connects to Pins 10, 1, and 2; Section No. 3 connects to Pins 1, 2, and 3.
- (2) Shield No. 315 ties to cathode of triode under test.

**6J10**

13J10/13Z10

Color Television Type

**FM DISCRIMINATOR and  
AUDIO POWER AMPLIFIER**

**Double Dissimilar Pentodes**

Construction..... Compactron T-9  
 Base ..... Button 12 Pin, E12-70  
 Basing ..... 12BT  
 Outline ..... 9-58  
 Maximum Diameter ..... 1.188 In.  
 Maximum Seated Height ..... 2.000 In.  
 Maximum Overall Height ..... 2.375 In.

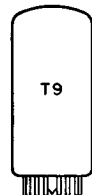
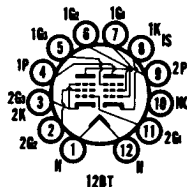



**ELECTRICAL DATA****HEATER OPERATION**

	13J10/13Z10	6J10
Heater Voltage.....	13.2	6.3 Volts
Heater Current .....	450	950 Ma
Heater Warm-up Time .....	11	— Seconds
Maximum Heater-Cathode Voltage		
Heater Negative with Respect to Cathode		
Total DC and Peak.....		200 Volts
Heater Positive with Respect to Cathode		
DC .....		100 Volts
Total DC and Peak.....		200 Volts

**DIRECT INTERELECTRODE CAPACITANCES (Unshielded)****Section No. 1**

Grid No. 1 to All.....	4.0 Pf
Grid No. 3 to All.....	3.2 Pf
Grid No. 1 to Grid No. 3 .....	0.01 Pf

**Section No. 2**

Grid to Plate .....	0.2 Pf
Input .....	11.0 Pf
Output .....	7.0 Pf

**RATINGS (Design Maximum Rating System)****Section No. 1**

Plate Supply Voltage (Max.) .....	330 Volts
Accelerator Voltage (G2) (Max.) .....	110 Volts
Peak Positive G1 Voltage (Max.) .....	60 Volts
DC Cathode Current (Max.) .....	13 Ma

**Section No. 2**

Plate Voltage (Max.) .....	275 Volts
Screen Voltage (Max.) .....	275 Volts
Plate Dissipation (Max.) .....	10.0 Watts
Screen Dissipation (Max.) .....	2.0 Watts
Grid No. 1 Circuit Resistance	
Fixed Bias (Max.) .....	0.25 Megohms
Cathode Bias (Max.) .....	0.5 Megohm

**CHARACTERISTICS AND TYPICAL OPERATION****Section No. 1****Gated Beam Discriminator Section—Limiter/Discriminator Service**

Input Signal Center Frequency .....	10.7	10.7	4.5 MHz
Frequency Deviation .....	± 75	± 75	± 25 KHz
Plate Supply Voltage.....	85	285	270 Volts
Plate Voltage .....	62	122	121 Volts
Accelerator Voltage .....	55	100	100 Volts
Cathode Bias Resistor—Variable <sup>(1)</sup> .....	200-400	200-400	200-400 Ohms
Plate Load Resistor .....	0.085	0.330	0.330 Megohms
Plate Linearity Resistor .....	470	1500	1000 Ohms
Integrating Capacitor .....	0.002	0.001	0.001 Pf
Coupling Capacitor .....	0.25	0.01	0.25 Pf
Minimum Signal Voltage for			
Limiting Action, rms <sup>(2)</sup> .....	1.25	1.25	1.25 Volts
DC Plate Current .....	0.25	0.49	0.44 Ma
Accelerator Current .....	4.1	9.8	10 Ma
Input Signal Level for AM Rejection Adjustment <sup>(1)</sup> .....	1.25	2.0	2.0 Volts
AM Rejection at Esig = 2.0 Volts, rms .....	31	20	25 db
AM Rejection at Esig = 3.0 Volts, rms .....	30	29	30 db
Total Harmonic Distortion .....	2.0	1.6	1.8 Percent
Peak Audio Output Voltage .....	6.0	16.6	16.8 Volts

**Section No. 2****Power Amplifier**

Plate Voltage .....	250 Volts
Screen Voltage.....	250 Volts
Grid No. 1 Voltage .....	-8.0 Volts
Peak AF Grid Voltage .....	8.0 Volts
Plate Resistance (Approx.) .....	100,000 Ohms
Transconductance .....	6500 $\mu$ mhos
Zero Signal Plate Current .....	35 Ma
Maximum Signal Plate Current .....	39 Ma
Zero Signal Screen Current .....	2.5 Ma
Maximum Signal Screen Current .....	7.0 Ma
Load Resistance .....	5000 Ohms
Total Harmonic Distortion (Approx.) .....	10 Percent
Maximum Signal Power Output .....	4.2 Watts

**NOTES:**

- (1) The cathode resistor should be adjusted for maximum AM rejection in the output of the limiter-discriminator stage at the specified signal level. AM rejection is measured with an applied signal containing 30% AM and 30% FM.
- (2) At signal levels above specified value, limiting is within  $\pm 3$  decibels. Adequate shielding between components of the limiter grid and the quadrature grid must be used to insure proper phasing of the voltage developed at the quadrature grid. Standard de-emphasis requirements for FM are included. The Q of the quadrature grid circuit should be high enough to develop a minimum of 4 volts (rms) signal with 2 volts (rms) of the center-frequency signal applied to the limiter grid. It is recommended that the coil be shunted by a minimum of 10 Pf. The capacitance may be composed of tube input capacitance, stray capacitance, and distributed capacitance, as well as physical capacitance.

# 6J11

# IF AMPLIFIER

**Double Sharp Cutoff Pentode**

Construction ..... Compactron T-9  
 Base ..... Button 12 Pin, E12-70  
 Basing ..... 12BW  
 Outline ..... 9-58  
     Maximum Diameter ..... 1.188 In.  
     Maximum Seated Height ..... 2.000 In.  
     Maximum Overall Height ..... 2.375 In.

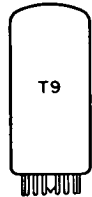
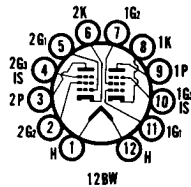

**ELECTRICAL DATA**

**HEATER OPERATION**

Heater Voltage.....	6.3 Volts
Heater Current.....	800 Ma
Maximum Heater-Cathode Voltage	
Heater Negative with Respect to Cathode	
Total DC and Peak.....	200 Volts
Heater Positive with Respect to Cathode	
DC.....	100 Volts
Total DC and Peak.....	200 Volts

**DIRECT INTERELECTRODE CAPACITANCES (Shielded)<sup>(1)</sup>**

**Section 1**

Grid No. 1 to Plate (Max.) .....	0.04 Pf
Input: 1g1 to (h + 1k + 1g2 + 1g3 + 2g3 + 1S) .....	11 Pf
Output: 1p to (h + 1k + 1g2 + 1g3 + 2g3 + 1S) .....	2.8 Pf

**Section 2**

Grid No. 1 to Plate (Max.) .....	0.04 Pf
Input: 2g1 to (h + 2k + 2g2 + 2g3 + 1g3 + 1S) .....	11 Pf
Output: 2p to (h + 2k + 2g2 + 2g3 + 1g3 + 1S) .....	3.2 Pf
Cathode Section 1 to Cathode, Section 2 (Max.) .....	0.02 Pf
Grid No. 1, Section 1 to Plate, Section 2 (Max.) .....	0.003 Pf
Grid No. 1, Section 2 to Plate, Section 1 (Max.) .....	0.003 Pf
Plate, Section 1 to Plate, Section 2 (Max.) .....	0.03 Pf

**RATINGS (Design Maximum Rating System) (Each Section)**

Plate Voltage (Max.) .....	330 Volts
Screen-Supply Voltage (Max.) .....	330 Volts
Screen Voltage .....	See Rating Chart (Gen. Info. Sec.)
Positive DC Grid No. 1 Voltage (Max.) .....	0 Volt
Plate Dissipation (Max.) .....	3.1 Watts
Screen Dissipation (Max.) .....	0.65 Watts
Grid No. 1 Circuit Resistance with Cathode Bias (Max.) .....	0.25 Megohm

**CHARACTERISTICS AND TYPICAL OPERATION (Each Section)**

Plate Voltage .....	125 Volts
Suppressor .....	Connected to Cathode at Socket
Screen Voltage.....	125 Volts
Cathode-Bias Resistor .....	56 Ohms
Plate Resistance (Approx.) .....	0.2 Megohm
Transconductance .....	13,000 $\mu$ mhos
Plate Current .....	11 Ma
Screen Current .....	3.8 Ma
Grid No. 1 Voltage, (Approx.) .....	
I <sub>b</sub> = 20 $\mu$ a .....	-3 Volts

**NOTE:**

- (1) Shield No. 309 connected to cathode of section under test.

**SYNC SEPARATOR/CLIPPER, PHASE  
INVERTER (T)  
VIDEO AMPLIFIER (P)**

**6JA8**

10JA8

**High Mu Triode and  
Beam Power Pentode**

Construction ..... Miniature T-6½  
Base ..... Button 9 Pin, E9-1  
Basing ..... 9DX  
Outline ..... 6-3  
Maximum Diameter ..... 0.875 In.  
Maximum Seated Height ..... 2.375 In.  
Maximum Overall Height ..... 2.625 In.

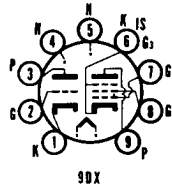

**ELECTRICAL DATA  
HEATER OPERATION**

	10JA8	6JA8
Heater Voltage .....	10.5	6.3 Volts
Heater Current .....	450	750 Ma
Heater Warm-up Time .....	11	— Seconds
Maximum Heater-Cathode Voltage		
Heater Negative with Respect to Cathode		
Total DC and Peak .....		200 Volts
Heater Positive with Respect to Cathode		
DC .....		100 Volts
Total DC and Peak .....		200 Volts

**DIRECT INTERELECTRODE CAPACITANCES (Unshielded)**

**Triode Section**

Grid to Plate .....	4.0 Pf
Input: g to (h + Tk + Pk, g3, IS) .....	2.6 Pf
Output: p to (h + Tk + Pk, g3, IS) .....	2.6 Pf

**Pentode Section**

Grid No. 1 to Plate (Max.) .....	0.1 Pf
Input: g1 to (h + Pk, g3, IS + g2) .....	11 Pf
Output: p to (h + Pk, g3, IS + g2) .....	4.4 Pf

**Coupling**

Triode Grid to Pentode Plate (Max.) .....	0.005 Pf
Pentode Grid No. 1 to Triode Plate (Max.) .....	0.018 Pf
Pentode Plate to Triode Plate (Max.) .....	0.17 Pf

**RATINGS (Design Maximum Rating System)**

	Triode Section	Pentode Section
Plate Voltage (Max.) .....	300	330 Volts
Grid No. 2 Supply Voltage (Max.) .....	—	330 Volts
Grid No. 2 Voltage .....	See Rating Chart (Gen. Info. Sec.)	
Positive Grid No. 1 Voltage (Max.) .....	0	0 Volt
Plate Dissipation (Max.) .....	1.0	5.0 Watts
Grid No. 2 Dissipation (Max.) .....	—	1.5 Watts
Grid No. 1 Circuit Resistance		
Fixed Bias (Max.) .....	0.5	0.25 Megohm
Cathode Bias (Max.) .....	1.0	1.0 Megohm

**CHARACTERISTICS AND TYPICAL OPERATION**

	Triode Section		Pentode Section	
Plate Voltage .....	135	200	135	200 Volts
Grid No. 2 Voltage .....	—	—	135	135 Volts
Grid No. 1 Voltage .....	-2	-2	-1.5	-1.5 Volts
Plate Current .....	1.0	3.5	17	18 Ma
Grid No. 2 Current .....	—	—	4.2	4.0 Ma
Transconductance .....	1550	3700	12,000	14,000 μmhos
Amplification Factor .....	60	70	—	—
Plate Resistance (Approx.) .....	39,000	19,000	66,000	70,000 Ohms
Ec1 for Ib = 100 μa (Approx.) .....	—	—	-5	-5 Volts
Ec1 for Ib = 10 μa (Approx.) .....	-4.8	-7.0	—	— Volts

**INSTANTANEOUS PLATE KNEE CHARACTERISTICS (Pentode Section)**

Eb = 30 V, Ec2 = 135 V and Ec1 = 0 V  
Ib = 32 Ma and Ic2 = 14 Ma

# 6JB6

12JB6, 17JB6

# HORIZONTAL DEFLECTION AMPLIFIER

**Beam Power Pentode**

Construction .....Novar T-12  
 Base .....Button 9 Pin, E9-76  
 Top Cap .....C1-2 or C1-3  
 Basing .....9QL  
 Outline  
 Maximum Diameter .....1.563 In.  
 Maximum Seated Height .....3.170 In.  
 Maximum Overall Height .....3.550 In.

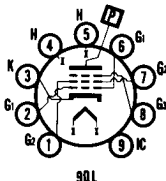

**ELECTRICAL DATA**

**HEATER OPERATION**

	17JB6	12JB6	6JB6
Heater Voltage.....	16.8	12.6	6.3 Volts
Heater Current .....	450	600	1200 Ma
Heater Warm-up Time .....	11	11	— Seconds

**Maximum Heater-Cathode Voltage**

Heater Negative with Respect to Cathode	
Total DC and Peak.....	200 Volts
Heater Positive with Respect to Cathode	
DC .....	100 Volts
Total DC and Peak.....	200 Volts

**DIRECT INTERELECTRODE CAPACITANCES (Unshielded)**

Grid to Plate .....	0.2 Pf
Input: g1 to (h + k + g2 + g3) .....	15 Pf
Output: p to (h + k + g2 + g3) .....	6.0 Pf

**RATINGS (Design Maximum Rating System)**

**Horizontal Deflection Amplifier<sup>(1)</sup>**

DC Plate Supply Voltage (Boost + DC Power Supply) (Max.) .....	770 Volts
Peak Positive Plate Voltage (Max.) .....	6500 Volts
Peak Negative Plate Voltage (Max.) .....	1500 Volts
Grid No. 2 Voltage (Max.) .....	220 Volts
Peak Negative Grid No. 1 Voltage (Max.) .....	330 Volts
Plate Dissipation (Max.) <sup>(2)</sup> .....	17.5 Watts
Grid No. 2 Input (Max.) .....	3.5 Watts
Average Cathode Current (Max.).....	175 Ma
Peak Cathode Current (Max.) .....	550 Ma
Grid No. 1 Circuit Resistance (Max.) .....	1.0 Megohm
Bulb Temperature (At Hottest Point) (Max.) .....	240 °C

**CHARACTERISTICS AND TYPICAL OPERATION**

Plate Voltage .....	250 Volts
Grid No. 2 Voltage .....	150 Volts
Grid No. 1 Voltage .....	-22.5 Volts
Plate Current .....	70 Ma
Grid No. 2 Current .....	2.1 Ma
Transconductance .....	7100 μmhos
Amplification Factor <sup>(3)</sup> .....	4.4
Plate Resistance.....	15,000 Ohms
Ec1 for Ib = 1 Ma (Approx.) .....	-42 Volts

**INSTANTANEOUS PLATE KNEE VALUES**

Eb = 60 V, Ec2 = 150 V, and Ec1 = 0 V;  
 Ib = 390 Ma; and Ic2 = 32 Ma

**NOTES:**

- (1) For operation in a 525 line, 30 frame system as described in "Standards of Good Engineering Practice for Television Broadcast Stations; Federal Communications Commission," the duty cycle of the voltage pulse must not exceed 15% of one horizontal scanning cycle.
- (2) In stages operating with grid leak bias, an adequate cathode bias resistor or other suitable means is required to protect the tube in the absence of excitation.
- (3) Amplification factor with tube operating as a triode with 150 volts on the plate and Grid No. 2 and -22.5 volts on Grid No. 1.

**HORIZONTAL DEFLECTION  
AMPLIFIER**

**6JB6A**  
12JB6A, 17JB6A

**Beam Power Pentode**

Construction .....Novar T-12  
Base .....Button 9 Pin, E9-88  
Top Cap .....C1-2 or C1-3  
Basing .....9QL  
Outline

Maximum Diameter .....1.563 In.  
Maximum Seated Height .....3.125 In.  
Maximum Overall Height .....3.505 In.  
The Types 6JB6A, 12JB6A, and 17JB6A are identical to Types 6JB6, 12JB6, and 17JB6 except for base with exhaust tip at bottom and shorter bulb.

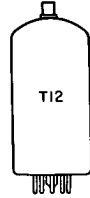
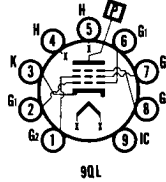

*Color Television Type*  
**IF AMPLIFIER**

**6JC6**  
3JC6, 4JC6

**Sharp Cutoff Pentode**

Construction .....Miniature T-6½  
Base .....Button 9 Pin, E9-1  
Basing .....9PM  
Outline .....6-2  
Maximum Diameter .....0.875 In.  
Maximum Seated Height .....1.938 In.  
Maximum Overall Height .....2.188 In.

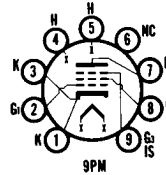

**ELECTRICAL DATA**

**HEATER OPERATION**

	3JC6	4JC6	6JC6
Heater Voltage.....	3.5	4.5	6.3 Volts
Heater Current.....	600	450	300 Ma
Heater Warm-up Time.....	11	11	— Seconds
Maximum Heater-Cathode Voltage			
Heater Negative with Respect to Cathode			
Total DC and Peak.....			200 Volts
Heater Positive with Respect to Cathode			
DC.....			100 Volts
Total DC and Peak.....			200 Volts

**DIRECT INTERELECTRODE CAPACITANCES (Unshielded)**

Grid No. 1 to Plate.....	0.019 Pf
Input: g1 to (h + k + g2 + g3 + 1S).....	8.2 Pf
Output: p to (h + k + g2 + g3 + 1S).....	3.0 Pf

**RATINGS (Design Maximum Rating System)**

Plate Voltage (Max.).....	330 Volts
Grid No. 3 Voltage (Max.).....	0 Volt
Grid No. 2 Supply Voltage (Max.).....	330 Volts
Grid No. 2 Voltage (Max.).....	See Rating Chart (Gen. Info. Sec.)
Grid No. 1 Voltage	
Positive Bias Value (Max.).....	0 Volt
Grid No. 2 Input	
Ec2 up to 165 Volts (Max.).....	0.6 Watts
Ec2 = 165 to 330 Volts (Max.).....	See Rating Chart (Gen. Info. Sec.)
Plate Dissipation (Max.).....	2.5 Watts
Grid No. 1 Circuit Resistance	
Fixed Bias (Max.).....	0.25 Megohm
Cathode Bias (Max.).....	1 Megohm

**CHARACTERISTICS AND TYPICAL OPERATION****Class A1 Amplifier**

Plate Supply Voltage.....	125 Volts
Grid No. 3 Voltage .....	Connected to Cathode at Socket
Grid No. 2 Supply Voltage.....	125 Volts
Cathode Resistor .....	56 Ohms
Plate Current .....	13 Ma
Grid No. 2 Current .....	3.2 Ma
Transconductance .....	15,000 $\mu$ mhos
Plate Resistance (Approx.) .....	180,000 Ohms
Grid No. 1 Voltage for $I_b = 100 \mu a$ .....	-3 Volts

**6JC6A**

3JC6A, 4JC6A

Color Television Type

**IF AMPLIFIER****Sharp Cutoff Pentode**

Construction .....	Miniature T-6½
Base .....	Button 9 Pin, E9-1
Basing .....	9PM
Outline .....	6-2
Maximum Diameter .....	0.875 In.
Maximum Seated Height .....	1.938 In.
Maximum Overall Height .....	2.188 In.

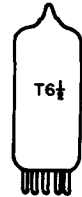
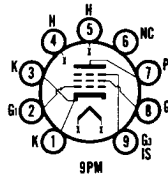
**ELECTRICAL DATA****HEATER OPERATION**

	3JC6A	4JC6A	6JC6A
Heater Voltage.....	3.5	4.5	6.3 Volts
Heater Current .....	600	450	300 Ma
Heater Warm-up Time .....	11	11	— Seconds
Maximum Heater-Cathode Voltage			
Heater Negative with Respect to Cathode			
Total DC and Peak.....			200 Volts
Heater Positive with Respect to Cathode			
DC .....			100 Volts
Total DC and Peak.....			200 Volts

**DIRECT INTERELECTRODE CAPACITANCE (Unshielded)**

Grid No. 1 to Plate .....	0.019 Pf
Input: g1 to (h + k + g2 + g3 + IS).....	8.5 Pf
Output: p to (h + k + g2 + g3 + IS).....	3.0 Pf

**RATINGS (Design Maximum Rating System)**

Plate Voltage (Max.) .....	330 Volts
Grid No. 3 Voltage (Max.) .....	0 Volt
Grid No. 2 Supply Voltage (Max.) .....	330 Volts
Grid No. 2 Voltage .....	See Rating Chart (Gen. Info. Sec.)
Grid No. 1 Voltage (Positive Bias Value) .....	0 Volt
Grid No. 2 Input	
Ec2 up to 165 Volts (Max.) .....	0.7 Watts
Ec2 = 165 to 330 Volts .....	See Rating Chart (Gen. Info. Sec.)
Plate Dissipation (Max.) .....	3.1 Watts
Grid No. 1 Circuit Resistance	
Fixed Bias (Max.) .....	0.25 Megohm
Cathode Bias (Max.) .....	1 Megohm

**CHARACTERISTICS AND TYPICAL OPERATION****Class A1 Amplifier**

Plate Supply Voltage.....	125 Volts
Grid No. 3 Voltage .....	Connected to Cathode at Socket
Grid No. 2 Supply Voltage.....	125 Volts
Cathode Resistor .....	56 Ohms
Plate Current .....	14 Ma
Grid No. 2 Current .....	3.4 Ma
Transconductance .....	16,000 $\mu$ mhos
Plate Resistance (Approx.) .....	180,000 Ohms
Grid No. 1 Voltage for $I_b = 100 \mu a$ .....	-3 Volts

**VHF OSCILLATOR and MIXER**

**6JC8**

**Medium Mu Triode and Sharp Cutoff Pentode**

Construction ..... Miniature T-6½  
 Base ..... Button 9 Pin, E9-1  
 Basing ..... 9PA  
 Outline ..... 6-2  
 Maximum Diameter ..... 0.875 In.  
 Maximum Seated Height ..... 1.937 In.  
 Maximum Overall Height ..... 2.187 In.

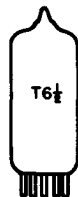
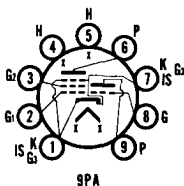

**ELECTRICAL DATA**

**HEATER OPERATION**

Heater Voltage.....	6.3 Volts
Heater Current.....	450 Ma
Heater Warm-up Time.....	11 Seconds
Maximum Heater-Cathode Voltage	
Heater Negative with Respect to Cathode	
Total DC and Peak.....	200 Volts
Heater Positive with Respect to Cathode	
DC.....	100 Volts
Total DC and Peak.....	200 Volts

**DIRECT INTERELECTRODE CAPACITANCES**

	Shielded	Unshielded
<b>Triode Section</b>		
Grid to Plate.....	1.2	1.3 Pf
Input: g to (h + k).....	3.2	2.8 Pf
Output: p to (h + k).....	0.90	0.44 Pf
<b>Pentode Section</b>		
Grid No. 1 to Plate (Max.).....	0.018	0.038 Pf
Input: g1 to (k + g3 + g2 + h).....	5.0	4.8 Pf
Output: p to (k + g3 + g2 + h).....	1.6	0.9 Pf
<b>Coupling</b>		
Pentode Grid No. 1 to Triode Plate (Max.).....	0.036	0.05 Pf
Pentode Plate to Triode Plate (Max.).....	0.012	0.075 Pf
Heater to Cathode.....	6.5 <sup>(a)</sup>	6.5 Pf

**RATINGS (Design Maximum Rating System)**

**Converter Service**

	Triode Section	Pentode Section
Plate Voltage (Max.).....	275	275 Volts
Grid No. 2 Supply Voltage (Max.).....	—	275 Volts
Grid No. 2 Voltage.....	See Rating Chart (Gen. Info. Sec.)	
Plate Dissipation (Max.).....	1.7	2.3 Watts
Grid No. 2 Input:		
For Grid No. 2 Voltages up to 138 Volts (Max.).....	—	0.45 Watt
For Grid No. 2 Voltages Between 138 and 275 Volts.....	See Rating Chart (Gen. Info. Sec.)	
Positive Grid No. 1 Voltage (Max.).....	0	0 Volt
Grid No. 1 Circuit Resistance		
Fixed Bias (Max.).....	—	0.1 Megohm
Self Bias (Max.).....	—	0.5 Megohm

**CHARACTERISTICS AND TYPICAL OPERATION**

	Triode Section	Pentode Section
Plate Voltage.....	125	125 Volts
Grid No. 3.....	Connected to Pin No. 3 at Socket	
Grid No. 2 Voltage.....	—	125 Volts
Grid No. 1 Voltage.....	-1.0	-1.0 Volt
Plate Current.....	12	9.0 Ma
Grid No. 2 Current.....	—	2.2 Ma
Transconductance.....	6500	5500 μmhos
Amplification Factor.....	40	—
Plate Resistance (Approx.).....	6000	300,000 Ohms
Ec1 for Ib = 20 μa (Approx.).....	-7	-6.5 Volts
Gm with Eb = 100 V, Ec2 = 70 V and Ec1 = 0 V.....	—	5700 μmhos

**NOTES:**

- (1) Shield No. 315 connected to Pin No. 3.  
 (2) Shield No. 315 connected to Pin No. 6.

**6JD6**

3JD6, 4JD6

Color Television Type

**IF AMPLIFIER****Sharp Cutoff Pentode**

Construction ..... Miniature T-6½  
 Base ..... Button 9 Pin, E9-1  
 Basing ..... 9PM  
 Outline ..... 6-2  
 Maximum Diameter ..... 0.875 In.  
 Maximum Seated Height ..... 1.937 In.  
 Maximum Overall Height ..... 2.187 In.

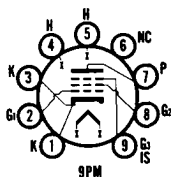
**ELECTRICAL DATA****HEATER OPERATION**

	3JD6	4JD6	6JD6
Heater Voltage.....	3.5	4.5	6.3 Volts
Heater Current .....	600	450	300 Ma
Heater Warm-up Time .....	11	11	— Seconds
<b>Maximum Heater-Cathode Voltage</b>			
Heater Negative with Respect to Cathode			
Total DC and Peak.....			200 Volts
Heater Positive with Respect to Cathode			
DC .....			100 Volts
Total DC and Peak.....			200 Volts

**DIRECT INTERELECTRODE CAPACITANCES (Unshielded)**

Grid No. 1 to Plate (Max.).....	0.019 Pf
Grid No. 1 to Cathode, Grid No. 3 and Internal Shield, Grid No. 2 and Heater .....	8.2 Pf
Plate to Cathode, Grid No. 3 and Internal Shield, Grid No. 2 and Heater .....	3.0 Pf

**RATINGS (Design Maximum Rating System)****Class A1 Amplifier**

Plate Voltage (Max.) .....	330 Volts
Grid No. 3 (Suppressor-Grid) Voltage: Positive Value (Max.) .....	0 Volt
Grid No. 2 (Screen-Grid) Supply Voltage (Max.).....	330 Volts
Grid No. 2 Voltage .....	See Rating Chart (Gen. Info. Sec.)
Grid No. 1 (Control Grid) Voltage: Positive-Bias Value (Max.) .....	0 Volt
Grid No. 2 Input:	
For Grid No. 2 Voltages up to 165 Volts (Max.) .....	0.6 Watt
For Grid No. 2 Voltages between 165 and 330 Volts .....	See Rating Chart (Gen. Info. Sec.)
Plate Dissipation (Max.) .....	2.5 Watts
Grid No. 1 Circuit Resistance	
Fixed Bias (Max.) .....	0.25 Megohm
Cathode Bias (Max.) .....	1 Megohm

**CHARACTERISTICS AND TYPICAL OPERATION****Class A1 Amplifier**

Plate Supply Voltage.....	125 Volts
Grid No. 3 Voltage .....	0 Volt
Grid No. 2 Supply Voltage.....	125 Volts
Grid No. 1 Supply Voltage.....	0 Volt
Cathode Resistor .....	56 Ohms
Plate Resistance (Approx.) .....	160,000 Ohms
Transconductance .....	14,000 $\mu$ hos
Plate Current .....	15 Ma
Grid No. 2 Current .....	4 Ma
Grid No. 1 Voltage (Approx.) for Transconductance ( $\mu$ hos) = 600 .....	-4.5 Volts



Color Television Type  
**HORIZONTAL DEFLECTION  
AMPLIFIER**

**6JE6C/6LQ6**  
24JE6A, 24LQ6, 31LQ6

**Beam Power Pentode**

Construction ..... Novar T-12  
 Base ..... Button 9 Pin, E9-88 or E9-76  
 Top Cap ..... C1-1  
 Basing ..... 9QL  
 Outline ..... 12-116  
     Maximum Diameter ..... 1.563 In.  
     Maximum Seated Height ..... 3.750 In.  
     Maximum Overall Height ..... 4.130 In.

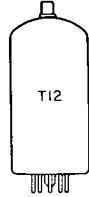
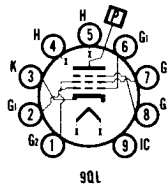

**ELECTRICAL DATA**

**HEATER OPERATION**

	31LQ6	24JE6A 24LQ6	6JE6C/6LQ6
Heater Voltage.....	31	24	6.3 Volts
Heater Current .....	450	600	2500 Ma
Heater Warm-up Time .....	11	11	— Seconds
<b>Maximum Heater-Cathode Voltage</b>			
Heater Negative with Respect to Cathode Total DC and Peak.....			200 Volts
Heater Positive with Respect to Cathode DC .....			100 Volts
Total DC and Peak.....			200 Volts

**DIRECT INTERELECTRODE CAPACITANCES (Unshielded)**

Grid to Plate .....	0.56 Pf
Input: g1 to (h + k + g2 + g3) .....	22 Pf
Output: p to (h + k + g2 + g3) .....	11 Pf

**RATINGS (Design Maximum Rating System)**

**Horizontal Deflection Amplifier<sup>(1)</sup>**

DC Plate Supply Voltage (Boost + DC Power Supply) (Max.) .....	990 Volts
Peak Positive Plate Voltage (Max.) .....	7500 Volts
Peak Negative Plate Voltage (Max.) .....	1200 Volts
Grid No. 3 Voltage (Max.) .....	75 Volts
Grid No. 2 Voltage (Max.) .....	220 Volts
Peak Negative Grid No. 1 Voltage (Max.) .....	330 Volts
Plate Dissipation (Max.) <sup>(2)</sup> .....	30 Watts
Grid No. 2 Input (Max.) .....	5 Watts
Average Cathode Current (Max.) .....	350 Ma
Peak Cathode Current (Max.) .....	1200 Ma
Grid No. 1 Circuit Resistance (Max.) <sup>(2)</sup> .....	0.47 Megohms
Plate Pulsed .....	10 Megohms
Bulb Temperature (At Hottest Point) .....	250 °C

**AVERAGE CHARACTERISTICS**

Plate Voltage .....	175	60 Volts
Grid No. 2 Voltage .....	125	125 Volts
Grid No. 1 Voltage .....	-25	0 Volts
Grid No. 3 Voltage .....	0	0 Volts
Plate Current .....	130	600 Ma
Grid No. 2 Current .....	2.8	30 Ma
Transconductance .....	10,500	— $\mu$ mhos
Triode Amplification Factor (Grid No. 2 Connected to Plate) (Eb = Ec2 = 125 Volts; Ec1 = -25 Volts) .....	3.0 <sup>(3)</sup>	—
Plate Resistance (Approx.) .....	5500	— Ohms
Grid No. 1 Voltage for Ib = 1 Ma (Approx.) .....	-54	— Volts

**SPECIAL TESTS AND RATINGS**

**Primary Beam—Plate Emission<sup>(4)</sup>**

Initial Maximum .....	100 $\mu$ a
After 1000 Hours of Operation Within Ratings (Max.) .....	100 $\mu$ a

**NOTES:**

- (1) For operation in a 525 line, 30 frame system as described in "Standards of Good Engineering Practice for Television Broadcast Stations; Federal Communications Commission," the duty cycle of the voltage pulse must not exceed 15% of one horizontal scanning cycle.
- (2) In stages operating with grid leak bias, an adequate cathode bias resistor or other suitable means is required to protect the tube in the absence of excitation.
- (3) Amplification factor with tube operating as a triode with 125 volts on the plate and Grid No. 2 and -25 volts on Grid No. 1.

# 6JE8

8JE8, 11JE8

## SYNC SEPARATOR or VOLTAGE AMP. (T) VIDEO AMPLIFIER (P)

### High Mu Triode and Sharp Cutoff Pentode

Construction ..... Miniature T-6½  
 Base ..... Button 9 Pin, E9-1  
 Basing ..... 9DX  
 Outline ..... 6-3  
 Maximum Diameter ..... .0.875 In.  
 Maximum Seated Height ..... 2.375 In.  
 Maximum Overall Height ..... 2.625 In.

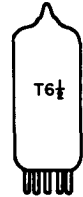
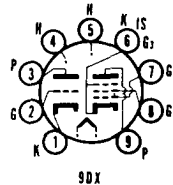

### ELECTRICAL DATA

#### HEATER OPERATION

	11JE8	8JE8	6JE8
Heater Voltage.....	10.9	8.2	6.3 Volts
Heater Current .....	450	600	780 Ma
Heater Warm-up Time .....	11	11	— Seconds
Maximum Heater-Cathode Voltage			
Heater Negative with Respect to Cathode			
Total DC and Peak.....			200 Volts
Heater Positive with Respect to Cathode			
DC .....			100 Volts
Total DC and Peak.....			200 Volts

#### DIRECT INTERELECTRODE CAPACITANCES (Unshielded)

##### Triode Section

Grid to Plate .....	4.2 Pf
Input: g to (h + k) .....	2.4 Pf
Output: p to (h + k) .....	0.4 Pf

##### Pentode Section

Grid No. 1 to Plate (Max.).....	0.1 Pf
Input: g1 to (h + k + g2 + g3 + IS).....	10 Pf
Output: p to (h + k + g2 + g3 + IS).....	3.6 Pf

##### Coupling

Pentode Grid No. 1 to Triode Plate (Max.) .....	0.005 Pf
Triode Grid to Pentode Plate (Max.) .....	0.018 Pf
Pentode Plate to Triode Plate (Max.) .....	0.17 Pf

#### RATINGS (Design Maximum Rating System)

Plate Voltage (Max.) .....	300	330 Volts
Grid No. 2 Supply Voltage.....	—	330 Volts
Grid No. 2 Voltage .....	See Rating Chart (Gen. Info. Sec.)	
Plate Dissipation (Max.) .....	1.0	5 <sup>(1)</sup> Watts
Grid No. 2 Dissipation (Max.) .....	—	2 <sup>(1)</sup> Watts
Positive Grid No. 1 Voltage (Max.) .....	0	0 Volt
Grid No. 1 Circuit Resistance		
Fixed Bias (Max.) .....	0.5	0.25 Megohm
Self Bias (Max.) .....	1.0	1.0 Megohm

#### CHARACTERISTICS AND TYPICAL OPERATION

	Triode Section	Pentode Section
<b>Class A1 Amplifier</b>		
Plate Voltage .....	200	250 Volts
Grid No. 2 Voltage .....	—	170 Volts
Grid No. 1 Voltage .....	-2	0 Volts
Cathode Bias Resistor .....	—	82 Ohms
Plate Current .....	4.5	22 Ma
Grid No. 2 Current .....	—	4.0 Ma
Transconductance .....	4200	12,000 μmhos
Amplification Factor .....	70	—
Plate Resistance (Approx.) .....	—	140,000 Ohms
Ec1 for Ib = 10 μa (Approx.) .....	-5	-10 Volts

#### INSTANTANEOUS PLATE KNEE CHARACTERISTICS

Eb = 60 V; Ec2 = 170 V, and Ec1 = 0 V  
 Ib = 48 Ma (Approx.) and Ic2 = 12 Ma (Approx.)

**NOTE:**

(1) These are design maximum dissipation ratings for television video amplifier applications. The two watts maximum Grid No. 2 Dissipation should not occur simultaneously with the five watts maximum plate dissipation. The two watts maximum Grid No. 2 Dissipation may be operated simultaneously with a Plate Dissipation of 4.0 Watts or 1.5 Watts Maximum Grid No. 2 Dissipation may be operated simultaneously with a Plate Dissipation of 5.0 Watts.

## HORIZONTAL DEFLECTION AMPLIFIER

## 6JF6

22JF6

**Beam Power Pentode**

Construction ..... Novar T-12  
 Base ..... Button 9 Pin, E9-88  
 Top Cap ..... C1-2 or C1-3  
 Basing ..... 9QL  
 Outline  
 Maximum Diameter ..... 1.563 In.  
 Maximum Seated Height ..... 3.170 In.  
 Maximum Overall Height ..... 3.550 In.

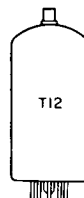
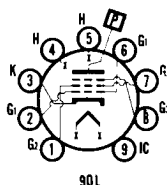

**ELECTRICAL DATA**

**HEATER OPERATION**

	22JF6	6JF6
Heater Voltage .....	22	6.3 Volts
Heater Current .....	450	1600 Ma
Heater Warm-up Time .....	11	— Seconds
Maximum Heater-Cathode Voltage		
Heater Negative with Respect to Cathode		
Total DC and Peak .....		200 Volts
Heater Positive with Respect to Cathode		
DC .....		100 Volts
Total DC and Peak .....		200 Volts

**DIRECT INTERELECTRODE CAPACITANCES (Unshielded)**

Grid No. 1 to Plate .....	1.2 Pf
Input: g1 to (k, g3, g2, H) .....	22.0 Pf
Output: p to (k, g3, g2, H) .....	9.0 Pf

**RATINGS (Design Maximum Rating System)**

**Horizontal Deflection Amplifier<sup>(1)</sup>**

DC Plate Supply Voltage (Boost + DC Power Supply) (Max.) .....	770 Volts
Peak Positive Pulse Plate Voltage (Max.) .....	6500 Volts
Peak Negative Pulse Plate Voltage (Max.) .....	1500 Volts
Grid No. 3 Voltage (Max.) .....	75 Volts
Plate Dissipation (Max.) <sup>(2)</sup> .....	100 Watts
Peak Negative Grid No. 1 Voltage (Max.) .....	330 Volts
Grid No. 2 Voltage (Max.) .....	220 Volts
Grid No. 2 Dissipation (Max.) .....	3.5 Watts
Average Cathode Current (Max.) .....	275 Ma
Peak Cathode Current (Max.) .....	950 Ma
Grid No. 1 Circuit Resistance (Max.) .....	2.2 Megohms
Bulb Temperature (At Hottest Point) (Max.) .....	240 °C

**CHARACTERISTICS AND TYPICAL OPERATION**

Plate Voltage .....	130 Volts
Grid No. 2 Voltage .....	125 Volts
Grid No. 1 Voltage .....	-20 Volts
Plate Current .....	80 Ma
Grid No. 2 Current .....	2.5 Ma
Transconductance .....	10,000 $\mu$ mos
Plate Resistance .....	12,000 Ohms
Amplification Factor <sup>(3)</sup> .....	4.1
Ec1 for Ib = 1.0 Ma (Approx.) .....	-40 Volts

**INSTANTANEOUS PLATE KNEE VALUES**

Eb = 50 V; Ec2 = 125 V and Ec1 = 0 V  
 Ib = 525 Ma, and Ic2 = 32 Ma

**NOTES:**

- (1) For operation in a 525 line, 30 frame system as described in "Standards of Good Engineering Practice for Television Broadcast Stations; Federal Communications Commission," the duty cycle of the voltage pulse must not exceed 15% of one horizontal scanning cycle.
- (2) In stages operating with grid leak bias, an adequate cathode bias resistor or other suitable means is required to protect the tube in the absence of excitation.
- (3) Amplification factor with tube operating as a triode with 125 volts on the plate and Grid No. 2 and -20 volts on Grid No. 1.

# 6JG6A

17JG6A, 22JG6A

## HORIZONTAL DEFLECTION AMPLIFIER

**Beam Power Pentode**

Construction ..... Novar T-12  
 Base ..... Button 9 Pin, E9-88  
 Basing ..... 9QU  
 Outline ..... 12-96  
 Maximum Diameter ..... 1.563 In.  
 Maximum Seated Height ..... 2.750 In.  
 Maximum Overall Height ..... 3.125 In.

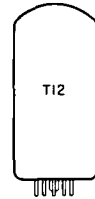
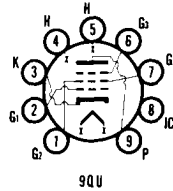

**ELECTRICAL DATA**

**HEATER OPERATION**

	22JG6A	17JG6A	6JG6A
Heater Voltage .....	22	16.8	6.3 Volts
Heater Current .....	450	600	1600 Ma
Heater Warm-up Time .....	11	11	— Seconds
<b>Maximum Heater-Cathode Voltage</b>			
Heater Negative with Respect to Cathode Total DC and Peak .....			200 Volts
Heater Positive with Respect to Cathode DC .....			100 Volts
Total DC and Peak .....			200 Volts

**DIRECT INTERELECTRODE CAPACITANCES (Unshielded)**

Grid No. 1 to Plate .....	0.7 Pf
Input .....	22 Pf
Output .....	9.0 Pf

**RATINGS (Design Maximum Rating System)**

<b>Horizontal Deflection Amplifier<sup>(1)</sup></b>	
DC Plate Supply Voltage (Boost + DC Power Supply) (Max.) .....	770 Volts
Peak Positive Pulse Plate Voltage (Max.) .....	6500 Volts
Peak Negative Pulse Plate Voltage (Max.) .....	1500 Volts
Grid No. 3 Voltage (Max.) .....	75 Volts
Plate Dissipation (Max.) .....	17 Watts
Peak Negative Grid No. 1 Voltage (Max.) .....	330 Volts
Grid No. 2 Voltage (Max.) .....	220 Volts
Grid No. 2 Dissipation (Max.) .....	3.5 Watts
Average Cathode Current (Max.) .....	275 Ma
Peak Cathode Current (Max.) .....	950 Ma
Grid No. 1 Circuit Resistance (Max.) .....	2.2 Megohms
Bulb Temperature (At Hottest Point) (Max.) .....	220 °C

**CHARACTERISTICS AND TYPICAL OPERATION**

Plate Voltage .....	130 Volts
Grid No. 2 Voltage .....	125 Volts
Grid No. 1 Voltage <sup>(2)</sup> .....	-20 Volts
Plate Current .....	80 Ma
Grid No. 2 Current .....	2.5 Ma
Transconductance .....	10,000 μmhos
Plate Resistance .....	12,000 Ohms
Amplification Factor <sup>(3)</sup> .....	4.1
E <sub>c1</sub> for I <sub>b</sub> = 10 Ma (Approx.) .....	-40 Volts

**INSTANTANEOUS PLATE KNEE VALUES**

E<sub>b</sub> = 50 V; E<sub>c2</sub> = 125 V and E<sub>c1</sub> = 0 V  
 I<sub>b</sub> = 525 Ma, and I<sub>c2</sub> = 32 Ma

**NOTES:**

- (1) For operation in a 525 line, 30 frame system as described in "Standards of Good Engineering Practice for Television Broadcast Stations; Federal Communications Commission," the duty cycle of the voltage pulse must not exceed 15% of one horizontal scanning cycle.
- (2) In stages operating with grid leak bias, an adequate cathode bias resistor or other suitable means is required to protect the tube in the absence of excitation.
- (3) Amplification factor with tube operating as a triode with 125 volts on the plate and Grid No. 2 and -20 volts on Grid No. 1.

Color Television Type  
**AGC/IF AMPLIFIER**

**6JH6**  
4JH6

**Semi-Remote Cutoff Pentode**

Construction ..... Miniature T-5½  
 Base ..... Button 7 Pin, E7-1  
 Basing ..... 7CM  
 Outline ..... 5-2  
     Maximum Diameter ..... 0.750 In.  
     Maximum Seated Height ..... 1.875 In.  
     Maximum Overall Height ..... 2.125 In.

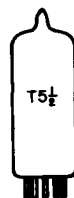
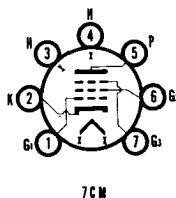

**ELECTRICAL DATA  
HEATER OPERATION**

	4JH6	6JH6
Heater Voltage.....	4.2	6.3 Volts
Heater Current .....	450	300 Ma
Heater Warm-up Time .....	11	— Seconds
Maximum Heater-Cathode Voltage		
Heater Negative with Respect to Cathode		
Total DC and Peak.....		200 Volts
Heater Positive with Respect to Cathode		
DC .....		100 Volts
Total DC and Peak.....		200 Volts

**DIRECT INTERELECTRODE CAPACITANCES**

	Shielded (1)	Unshielded
Grid No. 1 to Plate (Max.).....	0.015	0.025 Pf
Input: g1 to (h + k + g2 + g3 + IS).....	7.0	7.0 Pf
Output: p to (h + k + g2 + g3 + IS).....	3.0	2.0 Pf

**RATINGS (Design Maximum Rating System)**

Plate Voltage (Max.).....	300 Volts
Grid No. 2 Supply Voltage (Max.) .....	300 Volts
Grid No. 2 Voltage .....	See Rating Chart (Gen. Info. Sec.)
Plate Dissipation (Max.).....	2.3 Watts
Grid No. 2 Dissipation (Max.) .....	0.55 Watt
Grid No. 1 Circuit Resistance	
Fixed Bias (Max.) .....	0.25 Megohm
Cathode Bias (Max.) .....	1.0 Megohm

**CHARACTERISTICS AND TYPICAL OPERATION**

**Class A1 Amplifier**

Plate Voltage .....	125 Volts
Grid No. 2 Voltage .....	125 Volts
Grid No. 3 Voltage .....	Connected to Cathode at Socket
Cathode Bias Resistor .....	56 Ohms
Plate Current .....	14 Ma
Grid No. 2 Current .....	3.6 Ma
Transconductance .....	8000 μmhos
Plate Resistance (Approx.) .....	260,000 Ohms
Ec1 for gm = 50 μmhos (Approx.) .....	-19 Volts
Gm with Ec1 = -4.5 V, Rk = 56 Ohms.....	400 to 900 μmhos

**NOTE:**

(1) External Shield No. 316 connected to Pin No. 2 (cathode) at socket.

Color Television Type  
**SYNCHRONOUS DETECTOR**

**6JH8**

**Double Plate Sheet Beam Tube**

Construction ..... Miniature T-6½  
 Base ..... Button 9 Pin, E9-1  
 Basing(1) ..... 9DP  
 Outline ..... 6-3  
     Maximum Diameter ..... 0.875 In.  
     Maximum Seated Height ..... 2.375 In.  
     Maximum Overall Height ..... 2.625 In.

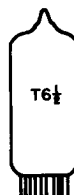
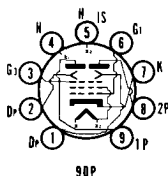

**ELECTRICAL DATA**

**HEATER OPERATION**

Heater Voltage.....	6.3 Volts
Heater Current .....	300 Ma

**DIRECT INTERELECTRODE CAPACITANCES (Unshielded)**

Deflector No. 1 to All.....	4.8 Pf
Deflector No. 2 to All.....	4.8 Pf
G1 to All (Except Plates) .....	7.5 Pf
Plate No. 1 to All.....	5.0 Pf
Plate No. 2 to All.....	5.0 Pf
G1 to Deflector No. 1 (Max.) .....	0.04 Pf
G1 to Deflector No. 2 (Max.) .....	0.07 Pf
Plate No. 1 to Plate No. 2 .....	0.40 Pf
Deflector No. 1 to Deflector No. 2 .....	0.38 Pf

**RATINGS (Design Maximum Rating System)**

Plate Voltage (Each Plate) (Max.).....	330 Volts
Accelerator Voltage (Max.).....	330 Volts
Peak Positive Deflector Voltage (Max.) .....	165 Volts
Peak Negative Deflector Voltage (Max.) .....	165 Volts
Positive DC G1 Voltage (Max.) .....	0 Volt
Plate Dissipation (Each Plate) (Max.).....	3.0 Watts
Accelerator Dissipation (Max.).....	1.0 Watts
DC Cathode Current (Max.) .....	33 Ma
G1 Circuit Resistance	
Fixed Bias (Max.) .....	0.1 Megohm
Cathode Bias (Max.) .....	0.25 Megohm

**CHARACTERISTICS AND TYPICAL OPERATION**

**Deflector Grounded<sup>(1)</sup>**

Plate No. 1 Voltage .....	250 Volts
Plate No. 2 Voltage (Tied to Plate No. 1) .....	250 Volts
Accelerator Voltage .....	250 Volts
Deflector No. 1 Voltage .....	0 Volt
Deflector No. 2 Voltage .....	0 Volt
Cathode Resistor .....	220 Ohms
Plate Current (Total).....	14 Ma
Accelerator Current.....	1.5 Ma
Transconductance .....	4400 $\mu$ mhos
G1 Voltage for Ib = 10 $\mu$ a.....	-13 Volts

**AVERAGE DEFLECTOR CHARACTERISTICS<sup>(2)</sup>**

Plate No. 1 Voltage .....	250 Volts
Plate No. 2 Voltage .....	250 Volts
Accelerator Voltage .....	250 Volts
Cathode Resistor .....	220 Ohms
Deflector Switching Voltage (Max.) <sup>(2)</sup> .....	20 Volts
Deflector-Bias for Minimum Deflector Switching Voltage .....	-14 Volts
Voltage Difference Between Deflectors for Ib1 = Ib2 (Approx.) .....	0 Volt
Plate No. 1 Current (Ed1 = -15 Volts; Ed2 = +15 Volts) (Max.) .....	0.7 Ma
Plate No. 2 Current (Ed1 = +15 Volts; Ed2 = -15 Volts) (Max.) .....	0.7 Ma
Deflector No. 1 Current (Ed1 = +25 Volts; Ed2 = -25 Volts) (Max.) .....	0.1 Ma
Deflector No. 2 Current (Ed1 = -25 Volts; Ed2 = +25 Volts) (Max.) .....	0.1 Ma

**NOTES:**

- (1) Pin No. 5 should be tied directly to ground.
- (2) Deflector switching voltage is defined as the total voltage change on either deflector with an equal and opposite change on the other deflector required to switch the plate current from one plate to the other.
- (3) The 6JH8 should not be located so as to subject it to stray magnetic fields.



**Sharp Cutoff Pentode**

Construction .....	Miniature T-5½
Base .....	Button 7 Pin, E7-1
Basing .....	.....7CM
Outline .....	.....5-2
Maximum Diameter .....	0.750 In.
Maximum Seated Height .....	1.875 In.
Maximum Overall Height .....	2.125 In.

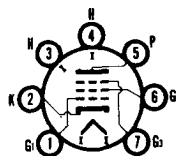

7CM



**ELECTRICAL DATA  
HEATER OPERATION**

	<b>4JK6</b>	<b>5JK6</b>	<b>6JK6</b>
Heater Voltage.....	3.7	4.9	6.3 Volts
Heater Current.....	600	450	350 Ma
Heater Warm-up Time.....	11	11	— Seconds
Maximum Heater-Cathode Voltage			
Heater Negative with Respect to Cathode			
Total DC and Peak.....			200 Volts
Heater Positive with Respect to Cathode			
DC.....			100 Volts
Total DC and Peak.....			200 Volts

**DIRECT INTERELECTRODE CAPACITANCES (Unshielded)**

Grid No. 1 to Plate (Max.).....	0.02 Pf
Input: g1 to (h + k + g2 + g3 + IS).....	9.5 Pf
Output: p to (h + k + g2 + g3 + IS).....	2.7 Pf

**RATINGS (Design Maximum Rating System)**

Plate Voltage (Max.).....	275 Volts
Grid No. 2 Supply Voltage (Max.).....	275 Volts
Grid No. 2 Voltage.....	See Rating Chart (Gen. Info. Sec.)
Plate Dissipation (Max.).....	2.5 Watts
Grid No. 2 Dissipation (Max.).....	0.6 Watt
Cathode Current (Max.).....	22 Ma
Grid No. 1 Circuit Resistance (Self Bias) (Max.).....	0.5 Megohm

**CHARACTERISTICS AND TYPICAL OPERATION**

**Class A1 Amplifier**

Plate Voltage.....	125 Volts
Grid No. 3 Voltage.....	Connected to Cathode at Socket
Grid No. 2 Voltage.....	125 Volts
Cathode Bias Resistor.....	68 Ohms
Plate Current.....	11.5 Ma
Grid No. 2 Current.....	3.9 Ma
Transconductance.....	18,000 $\mu$ mhos
Plate Resistance (Approx.).....	0.15 Megohm
Grid No. 1 Voltage for Ib = 20 $\mu$ a (Approx.).....	-3.5 Volts
R Input at 44 MHZ.....	4000 Ohms

**RF AMPLIFIER  
OSCILLATOR and MIXER**

**6JK8**

8JK8, 17JK8

**Double Dissimilar Triode**

Construction.....	Miniature T-6½
Base.....	Button 9 Pin, E9-1
Basing.....	9AJ
Outline.....	6-2
Maximum Diameter.....	0.875 In.
Maximum Seated Height.....	1.937 In.
Maximum Overall Height.....	2.187 In.

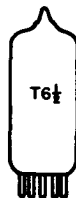
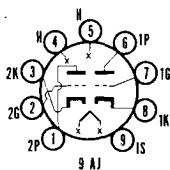

**ELECTRICAL DATA  
HEATER OPERATION**

	<b>17JK8</b>	<b>8JK8</b>	<b>6JK8</b>
Heater Voltage.....	16.8	8.4	6.3 Volts
Heater Current.....	150	300	400 Ma
Heater Warm-up Time.....	17	—	— Seconds
Maximum Heater-Cathode Voltage			
Heater Negative with Respect to Cathode			
Total DC and Peak.....			100 Volts
Heater Positive with Respect to Cathode			
Total DC and Peak.....			100 Volts

**DIRECT INTERELECTRODE CAPACITANCES (Shielded)**

	<b>Section No. 1</b>	<b>Section No. 2</b>
Grid to Plate.....	1.4	0.60 Pf
Input: g to (h + k + IS + E.S.).....	3.0	5.0 Pf
Output: p to (h + k + IS + E.S.).....	1.0	4.0 Pf
Heater to Cathode.....	2.8	2.8 Pf

Grid to Grid (Max.) .....	0.003	Pf
Plate to Plate (Max.).....	0.009	Pf

**RATINGS (Design Maximum Rating System)**

	Oscillator Section No. 1	R-F Amp. Section No. 2
Plate Voltage (Max.) .....	165	200 Volts
Plate Dissipation (Max.) .....	1.0	2.0 Watts
DC Cathode Current (Max.) .....	22	22 Ma
Negative Grid Voltage (Max.) .....	50	50 Volts
Grid Circuit Resistance (Self Bias) (Max.) .....	1.0	1.0 Megohms

**CHARACTERISTICS AND TYPICAL OPERATION**

	Oscillator Section No. 1	R-F Amp. Section No. 2
<b>Class A1 Amplifier</b>		
Plate Voltage .....	100	135 Volts
Grid Voltage .....	-1.0	-1.2 Volts
Plate Current .....	5.3	10 Ma
Transconductance .....	6800	13,000 $\mu$ mhos
Amplification Factor .....	55	70
Plate Resistance (Approx.) .....	8000	5400 Ohms
Ec for Ib = 20 $\mu$ a (Approx.).....	-4.4	- Volts
Ec for Gm = 150 $\mu$ mhos (Approx.) .....	—	-5.5 Volts
Ec for Gm = 1500 $\mu$ mhos (Approx.) .....	—	-2.8 Volts

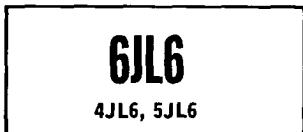

**Semi-Remote Cutoff Pentode**

Construction ..... Miniature T-5½  
 Base ..... Button 7 Pin, E7-1  
 Basing ..... 7CM  
 Outline ..... 5-2  
 Maximum Diameter ..... 0.750 In.  
 Maximum Seated Height ..... 1.875 In.  
 Maximum Overall Height ..... 2.125 In.

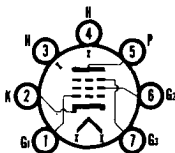

7CM



**ELECTRICAL DATA**

**HEATER OPERATION**

	4JL6	5JL6	6JL6
Heater Voltage.....	3.7	4.9	6.3 Volts
Heater Current .....	600	450	350 Ma
Heater Warm-up Time .....	11	11	— Seconds
Maximum Heater-Cathode Voltage			
Heater Negative with Respect to Cathode			
Total DC and Peak.....			200 Volts
Heater Positive with Respect to Cathode			
DC .....			100 Volts
Total DC and Peak.....			200 Volts

**DIRECT INTERELECTRODE CAPACITANCES (Unshielded)**

Grid No. 1 to Plate (Max.).....	0.02 Pf
Input: g1 to (h + k + g2 + g3 + IS).....	9.3 Pf
Output: p to (h + k + g2 + g3 + IS).....	2.7 Pf

**RATINGS (Design Maximum Rating System)**

Plate Voltage (Max.) .....	275 Volts
Grid No. 2 Supply Voltage (Max.) .....	275 Volts
Grid No. 2 Voltage .....	See Rating Chart (Gen. Info. Sec.)
Plate Dissipation (Max.) .....	2.5 Watts
Grid No. 2 Dissipation (Max.) .....	0.6 Watt
Cathode Current (Max.).....	22 Ma
Grid No. 1 Circuit Resistance (Self Bias) (Max.) .....	0.5 Megohm

**CHARACTERISTICS AND TYPICAL OPERATION**

**Class A1 Amplifier**

Plate Voltage .....	125 Volts
Grid No. 2 Voltage .....	60 Volts
Grid No. 3 Voltage .....	Connected to Cathode at Socket
Cathode Bias Resistor <sup>(1)</sup> .....	68 Ohms



Plate Current .....	12.5 Ma
Grid No. 2 Current .....	4.0 Ma
Transconductance .....	15,500 $\mu$ mhos
Plate Resistance (Approx.) .....	120,000 Ohms
E <sub>c1</sub> for gm = 1500 $\mu$ mhos (Approx.) .....	-2.7 Volts
E <sub>c1</sub> for gm = 150 $\mu$ mhos (Approx.) .....	-5.5 Volts

**NOTE:**

(1) Optimized unbypassed cathode resistor for gain controlled IF Service is 33 Ohms.

Color Television Type

## HORIZONTAL DEFLECTION AMPLIFIER

# 6JM6

17JM6

**Beam Power Pentode**

Construction..... Compactron T-12  
 Base ..... Button 12 Pin, E12-74  
 Top Cap ..... C1-3  
 Basing ..... 12FJ  
 Outline ..... 12-79  
 Maximum Diameter ..... 1.563 In.  
 Maximum Seated Height ..... 3.250 In.  
 Maximum Overall Height ..... 3.625 In.

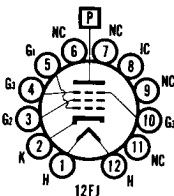

**ELECTRICAL DATA  
HEATER OPERATION**

Heater Voltage.....	<b>17JM6</b>	<b>6JM6</b>
Heater Current .....	16.8	6.3 Volts
Heater Warm-up Time .....	450	1200 Ma
Maximum Heater-Cathode Voltage	11	— Seconds
Heater Negative with Respect to Cathode		
Total DC and Peak.....		200 Volts
Heater Positive with Respect to Cathode		
DC .....		100 Volts
Total DC and Peak.....		200 Volts

**DIRECT INTERELECTRODE CAPACITANCES (Unshielded)**

Grid No. 1 to Plate .....	0.6 Pf
Input .....	16 Pf
Output .....	7 Pf

**RATINGS (Design Maximum Rating System)**

**Horizontal Deflection Amplifier<sup>(1)</sup>**

DC Plate Supply Voltage (Boost + DC Power Supply) (Max.) .....	770 Volts
Peak Positive Pulse Plate Voltage .....	6500 Volts
Peak Negative Pulse Plate Voltage (Max.) .....	1500 Volts
Positive DC Beam Plate Voltage .....	70 Volts
Plate Dissipation (Max.) <sup>(2)</sup> .....	17.5 Watts
Peak Negative Grid No. 1 Voltage (Max.) .....	330 Volts
Grid No. 2 Voltage (Max.) .....	220 Volts
Grid No. 2 Dissipation (Max.) .....	3.5 Watts
Average Cathode Current (Max.) .....	175 Ma
Peak Cathode Current (Max.) .....	550 Ma
Grid No. 1 Circuit Resistance (Max.) .....	1.0 Megohm
Bulb Temperature (at Hottest Point) (Max.) .....	220 °C

**CHARACTERISTICS AND TYPICAL OPERATION**

Plate Voltage .....	5000	250 Volts
Grid No. 2 Voltage .....	150	150 Volts
Grid No. 1 Voltage .....	—	-22.5 Volts
Plate Current .....	—	65 Ma
Grid No. 2 Current .....	—	1.8 Ma
Transconductance .....	—	7300 $\mu$ mhos
Plate Resistance.....	—	18,000 Ohms
Amplification Factor <sup>(3)</sup> .....	—	4.4
E <sub>c1</sub> for I <sub>b</sub> = 1.0 Ma (Approx.) .....	-100	-42 Volts

**INSTANTANEOUS PLATE KNEE VALUES**

E<sub>b</sub> = 60 V; E<sub>c2</sub> = 150 V and E<sub>c1</sub> = 0 V  
 I<sub>b</sub> = 345 Ma, and I<sub>c2</sub> = 27 Ma

**NOTES:**

(1) For operation in a 525 line, 30 frame system as described in "Standards of Good Engineering Practice for Television Broadcast Stations; Federal Communications Commission," the duty cycle of the voltage pulse must not exceed 15% of one horizontal scanning cycle.

- (2) In stages operating with grid leak bias, an adequate cathode bias resistor or other suitable means is required to protect the tube in the absence of excitation.
- (3) Amplification factor with tube operating as a triode with 150 volts on the plate and Grid No. 2 and -22.5 volts on Grid No. 1.

**6JM6A****17JM6A**

Color Television Type

**HORIZONTAL DEFLECTION AMPLIFIER****Beam Power Pentode**

Construction..... Compactron T-12  
 Base ..... Button 12 Pin, E12-74  
 Top Cap ..... C1-3  
 Basing..... 12FJ  
 Outline ..... 12-79  
 Maximum Diameter ..... 1.563 In.  
 Maximum Seated Height ..... 3.250 In.  
 Maximum Overall Height ..... 3.625 In.

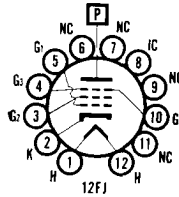
**ELECTRICAL DATA****HEATER OPERATION**

	<b>17JM6A</b>	<b>6JM6A</b>
Heater Voltage.....	16.8	6.3 Volts
Heater Current.....	450	1200 Ma
Heater Warm-up Time.....	11	— Seconds
Maximum Heater-Cathode Voltage		
Heater Negative with Respect to Cathode		
Total DC and Peak.....		200 Volts
Heater Positive with Respect to Cathode		
DC.....		100 Volts
Total DC and Peak.....		200 Volts

**DIRECT INTERELECTRODE CAPACITANCES (Unshielded)**

Grid No. 1 to Plate.....	0.6 Pf
Input.....	16 Pf
Output.....	7 Pf

**RATINGS (Design Maximum Rating System)****Horizontal Deflection Amplifier<sup>(1)</sup>**

DC Plate Supply Voltage (Boost + DC Power Supply) (Max.).....	770 Volts
Peak Positive Pulse Plate Voltage (Max.).....	6500 Volts
Peak Negative Pulse Plate Voltage (Max.).....	1500 Volts
Positive DC Beam Plate Voltage (Max.).....	70 Volts
Plate Dissipation (Max.) <sup>(2)</sup> .....	17.5 Watts
Negative DC Grid No. 1 Voltage (Max.).....	55 Volts
Peak Negative Grid No. 1 Voltage (Max.).....	330 Volts
Grid No. 2 Voltage (Max.).....	220 Volts
Grid No. 2 Dissipation (Max.).....	3.5 Watts
Average Cathode Current (Max.).....	175 Ma
Peak Cathode Current (Max.).....	550 Ma
Grid No. 1 Circuit Resistance (Max.).....	1.0 Megohm
Bulb Temperature (At Hottest Point) (Max.).....	220°C

**CHARACTERISTICS AND TYPICAL OPERATION**

Plate Voltage.....	5000	250 Volts
Grid No. 2 Voltage.....	150	150 Volts
Grid No. 1 Voltage.....	—	-22.5 Volts
Plate Current.....	—	70 Ma
Grid No. 2 Current.....	—	2.4 Ma
Transconductance.....	—	7300 $\mu$ mhos
Plate Resistance.....	—	15,000 Ohms
Amplification Factor <sup>(3)</sup> .....	—	4.4
E <sub>c1</sub> for I <sub>b</sub> = 1.0 Ma (Approx.).....	-100	-42 Volts

**INSTANTANEOUS PLATE KNEE VALUES**

E<sub>b</sub> = 55 V; E<sub>c2</sub> = 150 V and E<sub>c1</sub> = 0 V  
 I<sub>b</sub> = 345 Ma, and I<sub>c2</sub> = 30 Ma

**NOTES:**

- (1) For operation in a 525 line, 30 frame system as described in "Standards of Good Engineering Practice for Television Broadcast Stations; Federal Communications Commission," the duty cycle of the voltage pulse must not exceed 15% of one horizontal scanning cycle.
- (2) In stages operating with grid leak bias, an adequate cathode bias resistor or other suitable means is required to protect the tube in the absence of excitation.
- (3) Amplification factor with tube operating as a triode with 150 volts on the plate and Grid No. 2 and -22.5 volts on Grid No. 1.

**AVERAGE PLATE CHARACTERISTICS**

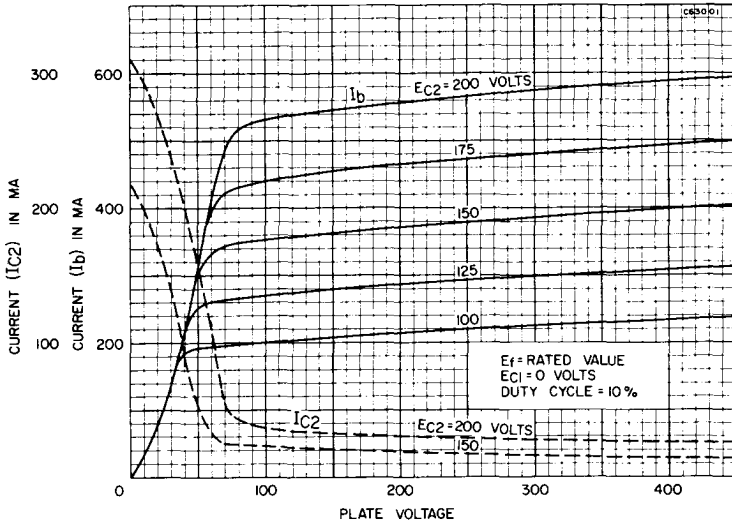

Color Television Type  
**HORIZONTAL DEFLECTION  
AMPLIFIER**

**6JN6**  
12JN6, 17JN6

**Beam Power Pentode**

Construction.....Compactron T-12  
Base .....Button 12 Pin, E12-74  
Basing .....12FK  
Outline .....12-56  
Maximum Diameter .....1.563 In.  
Maximum Seated Height .....2.500 In.  
Maximum Overall Height .....2.875 In.

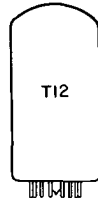
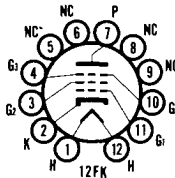

**ELECTRICAL DATA**

**HEATER OPERATION**

	17JN6	12JN6	6JN6
Heater Voltage.....	16.8	12.6	6.3 Volts
Heater Current.....	450	600	1200 Ma
Heater Warm-up Time.....	11	11	— Seconds
Maximum Heater-Cathode Voltage			
Heater Negative with Respect to Cathode			200 Volts
Heater Positive with Respect to Cathode			100 Volts
DC.....			200 Volts
Total DC and Peak.....			

**DIRECT INTERELECTRODE CAPACITANCES (Unshielded)**

Grid No. 1 to Plate.....	0.34 Pf
Input.....	16 Pf
Output.....	7 Pf

**RATINGS (Design Maximum Rating System)**

**Horizontal Deflection Amplifier<sup>(1)</sup>**

DC Plate Supply Voltage (Boost + DC Power Supply) (Max.).....	770 Volts
Peak Positive Pulse Plate Voltage.....	6500 Volts
Peak Negative Pulse Plate Voltage (Max.).....	1500 Volts
Positive DC Beam Plate Voltage (Max.).....	70 Volts
Plate Dissipation (Max.) <sup>(2)</sup> .....	17.5 Watts
Peak Negative Grid No. 1 Voltage (Max.).....	330 Volts
Grid No. 2 Voltage (Max.).....	220 Volts
Grid No. 2 Dissipation (Max.).....	3.5 Watts

Average Cathode Current (Max.).....	175 Ma
Peak Cathode Current (Max.).....	550 Ma
Grid No. 1 Circuit Resistance (Max.) .....	1.0 Megohm
Bulb Temperature (At Hottest Point) (Max.) .....	220 °C

**CHARACTERISTICS AND TYPICAL OPERATION**

Plate Voltage .....	5000	250 Volts
Grid No. 2 Voltage .....	150	150 Volts
Grid No. 1 Voltage .....	—	-22.5 Volts
Plate Current .....	—	65 Ma
Grid No. 2 Current .....	—	1.8 Ma
Transconductance .....	—	7300 μmhos
Plate Resistance.....	—	18,000 Ohms
Amplification Factor <sup>(3)</sup> .....	—	4.4
Ec1 for Ib = 1.0 Ma (Approx.) .....	-100	=42 Volts

**INSTANTANEOUS PLATE KNEE VALUES**

Eb = 60 V; Ec2 = 150 V, and Ec1 = 0 V  
 Ib = 345 Ma, and Ic2 = 27 Ma

**NOTES:**

- (1) For operation in a 525 line, 30 frame system as described in "Standards of Good Engineering Practice for Television Broadcast Stations; Federal Communications Commission," the duty cycle of the voltage pulse must not exceed 15% of one horizontal scanning cycle.
- (2) In duty operating with grid leak bias, an adequate cathode bias resistor or other suitable means is required to protect the tube in the absence of excitation.
- (3) Amplification factor with tube operating as a triode with 150 volts on the plate and Grid No. 2 and -22.5 volts on Grid No. 1.



**Beam Power Pentode**

Construction..... Compactron T-12  
 Base ..... Button 12 Pin, E12-74  
 Basing ..... 12FK  
 Outline ..... 12-56  
 Maximum Diameter ..... 1.563 In.  
 Maximum Seated Height ..... 2.500 In.  
 Maximum Overall Height ..... 2.875 In.

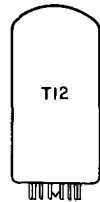
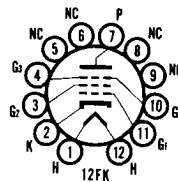

**ELECTRICAL DATA**

**HEATER OPERATION**

	17JN6A	12JN6A	6JN6A
Heater Voltage.....	16.8	12.6	6.3 Volts
Heater Current .....	450	600	1200 Ma
Heater Warm-up Time .....	11	11	— Seconds
Maximum Heater-Cathode Voltage			
Heater Negative with Respect to Cathode			
Total DC and Peak.....			200 Volts
Heater Positive with Respect to Cathode			
DC .....			100 Volts
Total DC and Peak.....			200 Volts

**DIRECT INTERELECTRODE CAPACITANCES (Unshielded)**

Grid No. 1 to Plate .....	0.34 Pf
Input .....	16 Pf
Output .....	7 Pf

**RATINGS (Design Maximum Rating System)**

**Horizontal Deflection Amplifier<sup>(1)</sup>**

DC Plate Supply Voltage (Boost + DC Power Supply) (Max.) .....	770 Volts
Peak Positive Pulse Plate Voltage .....	6500 Volts
Peak Negative Pulse Plate Voltage (Max.) .....	1500 Volts
Positive DC Beam Plate Voltage .....	70 Volts
Plate Dissipation (Max.) <sup>(2)</sup> .....	17.5 Watts
Negative DC Grid No. 1 Voltage (Max.).....	55 Volts
Peak Negative Grid No. 1 Voltage (Max.) .....	330 Volts
Grid No. 2 Voltage (Max.) .....	220 Volts
Grid No. 2 Dissipation (Max.) .....	3.5 Watts
Average Cathode Current (Max.).....	175 Ma
Peak Cathode Current (Max.) .....	550 Ma
Grid No. 1 Circuit Resistance (Max.) .....	1.0 Megohm
Bulb Temperature (At Hottest Point) (Max.) .....	220 °C

**CHARACTERISTICS AND TYPICAL OPERATION**

Plate Voltage .....	5000	250 Volts
Grid No. 2 Voltage .....	150	150 Volts
Grid No. 1 Voltage .....	—	-22.5 Volts
Plate Current .....	—	70 Ma
Grid No. 2 Current .....	—	2.4 Ma
Transconductance .....	—	7300 $\mu$ mhos
Plate Resistance.....	—	150,000 Ohms
Amplification Factor <sup>(3)</sup> .....	—	4.4
Ec1 for Ib = 1.0 Ma (Approx.) .....	-100	-42 Volts

**INSTANTANEOUS PLATE KNEE VALUES**

Eb = 55 V; Ec2 = 150 V and Ec1 = 0 V  
Ib = 345 Ma, and Ic2 = 30 Ma

**NOTES:**

- (1) For operation in a 525 line, 30 frame system as described in "Standards of Good Engineering Practice for Television Broadcast Stations; Federal Communications Commission," the duty cycle of the voltage pulse must not exceed 15% of one horizontal scanning cycle.
- (2) In stages operating with grid leak bias, an adequate cathode bias resistor or other suitable means is required to protect the tube in the absence of excitation.
- (3) Amplification factor with tube operating as a triode with 150 volts on the plate and Grid No. 2 and -22.5 volts on Grid No. 1.

**HORIZONTAL DEFLECTION OSC.  
and GENERAL PURPOSE TRIODE**

**6JN8**  
12JN8, 19JN8

**Medium Mu Triode and Sharp Cutoff Pentode**

Construction ..... Miniature T-6½  
Base ..... Button 9 Pin, E9-1  
Basing ..... 9FA  
Outline ..... 6-2  
Maximum Diameter ..... 0.875 In.  
Maximum Seated Height ..... 1.937 In.  
Maximum Overall Height ..... 2.187 In.

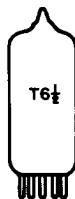
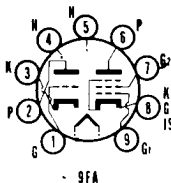

**ELECTRICAL DATA**

**HEATER OPERATION**

	19JN8	12JN8	6JN8
Heater Voltage.....	18.9	12.6	6.3 Volts
Heater Current .....	150	225	450 Ma
Maximum Heater-Cathode Voltage			
Heater Negative with Respect to Cathode			
Total DC and Peak.....			200 Volts
Heater Positive with Respect to Cathode			
DC .....			100 Volts
Total DC and Peak.....			200 Volts

**DIRECT INTERELECTRODE CAPACITANCES (Shielded)<sup>(1)</sup>**

**Pentode Section**

Grid No. 1 to Plate (Max.) (g1 to p) .....	0.01 Pf
Input: Pg1 to (h + Pk + Pg2 + Pg3 + IS) .....	5.5 Pf
Output: Pp to (h + Pk + Pg2 + Pg3 + IS) .....	3.4 Pf

**Triode Section**

Grid to Plate (g to p) .....	1.7 Pf
Input: g to (h + Tk + Pk + Pg3 + IS) .....	3.2 Pf
Output: p to (h + Tk + Pk + Pg3 + IS) .....	2.2 Pf

**RATINGS (Design Maximum Rating System)**

	Pentode Section	Triode Section
Plate Voltage (Max.) .....	300	300 Volts
Screen Supply Voltage (Max.) .....	300	— Volts
Screen Voltage .....	See Rating Chart (Gen. Info. Sec.)	
Positive DC Grid No. 1 Voltage (Max.) .....	0	0 Volt
Plate Dissipation (Max.) .....	2.5	2.5 Watts
Screen Dissipation (Max.) .....	0.55	— Watts
Grid No. 1 Circuit Resistance		
Fixed Bias (Max.) .....	2.2	2.2 Megohms
Cathode Bias (Max.) .....	2.2	2.2 Megohms

**CHARACTERISTICS AND TYPICAL OPERATION**

	<b>Pentode Section</b>	<b>Triode Section</b>
Plate Voltage .....	125	125 Volts
Screen Voltage .....	125	— Volts
Grid No. 1 Voltage .....	-1.0	-1.0 Volts
Amplification Factor .....	—	46
Plate Resistance (Approx.) .....	200,000	5400 Ohms
Transconductance .....	7500	8500 $\mu$ mhos
Plate Current .....	12	13.5 Ma
Screen Current .....	4.0	— Ma
Grid No. 1 Voltage (Approx.) .....		
I <sub>b</sub> = 10 $\mu$ a .....	-8	-8 Volts

**NOTE:**

(1) With external shield (EIA 315) connected to cathode of section under test.

6JS6C

12JS6, 23JS6A, 31JS6C

*Color Television Type*

HORIZONTAL DEFLECTION  
AMPLIFIER

**Beam Power Pentode**

Construction..... Compactron T-12  
 Base ..... Button 12 Pin, E12-74  
 Top Cap ..... C1-1  
 Basing ..... 12FY  
 Outline ..... 12-89  
     Maximum Diameter ..... 1.563 In.  
     Maximum Seated Height ..... 3.750 In.  
     Maximum Overall Height ..... 4.125 In.

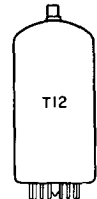
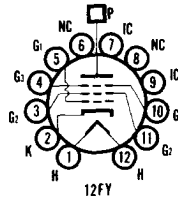

**ELECTRICAL DATA**

**HEATER OPERATION**

	<b>12JS6</b>	<b>31JS6C</b>	<b>23JS6A</b>	<b>6JS6C</b>
Heater Voltage .....	12.6	31.5	23.6	6.3 Volts
Heater Current .....	1125	450	600	2250 Ma
Heater Warm-up Time .....	—	11	11	— Seconds
Maximum Heater-Cathode Voltage				
Heater Negative with Respect to Cathode				
Total DC and Peak .....				200 Volts
Heater Positive with Respect to Cathode				
DC .....				100 Volts
Total DC and Peak .....				200 Volts

**DIRECT INTERELECTRODE CAPACITANCES (Unshielded)**

Grid to Plate .....	0.7 Pf
Input: g <sub>1</sub> to (h + k + g <sub>2</sub> + bp) .....	24 Pf
Output: p to (h + k + g <sub>2</sub> + bp) .....	10 Pf

**RATINGS (Design Maximum Rating System)**

**Horizontal Deflection Amplifier<sup>(1)</sup>**

DC Plate Supply Voltage (Boost + DC Power Supply) (Max.) .....	990 Volts
Peak Positive Plate Voltage (Max.) .....	7500 Volts
Peak Negative Plate Voltage (Max.) .....	1200 Volts
Positive DC Beam Plate Voltage (Max.) .....	75 Volts
Grid No. 2 Voltage (Max.) .....	220 Volts
Peak Negative Grid No. 1 Voltage (Max.) .....	330 Volts
Plate Dissipation (Max.) <sup>(2)</sup> .....	30 Watts
Grid No. 2 Input (Max.) .....	5.5 Watts
Average Cathode Current (Max.) .....	350 Ma
Peak Cathode Current (Max.) .....	1200 Ma
Grid No. 1 Circuit Resistance (Max.) <sup>(2)</sup> .....	0.47 Megohms
Grid No. 1 Circuit Resistance <sup>(4)</sup> .....	10.0 Megohms
Bulb Temperature (At Hottest Point) (Max.) .....	225 °C

**CHARACTERISTICS AND TYPICAL OPERATION**

Plate Voltage .....	175 Volts
Beam Plate Voltage .....	Connected to Cathode at Socket
Grid No. 2 Voltage .....	125 Volts
Grid No. 1 Voltage .....	-25 Volts

Plate Current .....	130 Ma
Grid No. 2 Current .....	2.8 Ma
Transconductance .....	11,500 $\mu$ mhos
Amplification Factor <sup>(3)</sup> .....	3
Plate Resistance .....	5500 Ohms
.....	-54 Volts

**INSTANTANEOUS PLATE KNEE VALUES**

$E_b = 62$  V,  $E_{c2} = 125$  V and  $E_{c1} = 0$  V;  $E_b = 70$  V (12JS6)  
 $I_b = 570$  Ma; and  $I_{c2} = 34$  Ma

**NOTES:**

- (1) For operation in a 525 line, 30 frame system as described in "Standards of Good Engineering Practice for Television Broadcast Stations; Federal Communications Commission," the duty cycle of the voltage pulse must not exceed 15% of one horizontal scanning cycle.
- (2) With Grid Bias Feedback HV Regulation.
- (3) Amplification factor with tube operation as a triode with 125 volts on the plate and Grid No. 2 and -25 volts on Grid No. 1.
- (4) With DC or Pulse Shunt HV Regulation.

**AVERAGE PLATE CHARACTERISTICS**

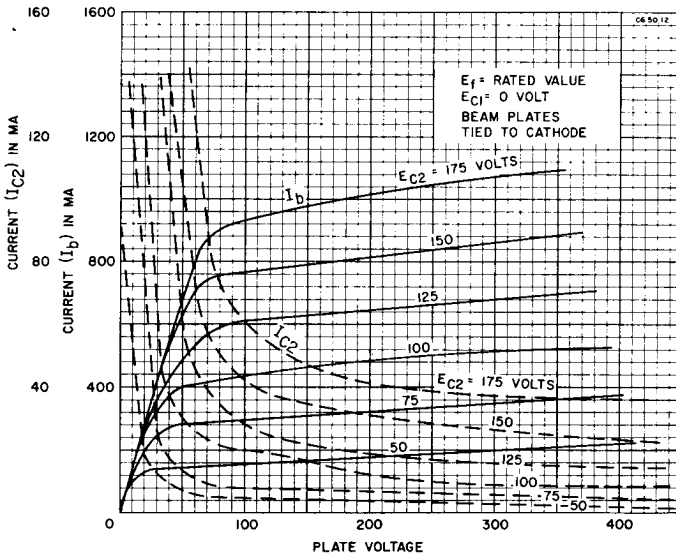

**HORIZONTAL DEFLECTION AMPLIFIER**

**6JT6**

12JT6, 17JT6

**Beam Power Pentode**

Construction .....Novar T-12  
 Base .....Button 9 Pin, E9-76  
 Basing .....9QU  
 Outline

Maximum Diameter .....1.563 In.  
 Maximum Seated Height .....2.800 In.  
 Maximum Overall Height .....3.180 In.

**ELECTRICAL DATA - HEATER OPERATION**

Heater Voltage.....  
 Heater Current .....  
 Heater Warm-up Time .....

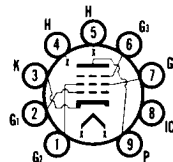

9QU

**17JT6**  
 16.8  
 450  
 11

**12JT6**  
 12.6  
 600  
 11

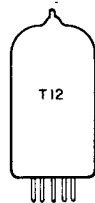

**6JT6**  
 6.3 Volts  
 1200 Ma  
 — Seconds

<b>Maximum Heater-Cathode Voltage</b>	
Heater Negative with Respect to Cathode	
Total DC and Peak.....	200 Volts
Heater Positive with Respect to Cathode	
DC .....	100 Volts
Total DC and Peak.....	200 Volts

**DIRECT INTERELECTRODE CAPACITANCES (Unshielded)**

Grid No. 1 to Plate .....	0.26 Pf
Input: G1 to (k, g3, g2, H) .....	15.0 Pf
Output: P to (k, g3, g2, H) .....	6.5 Pf

**RATINGS (Design Maximum Rating System)**

**Horizontal Deflection Amplifier<sup>(1)</sup>**

DC Plate Supply Voltage (Max.).....	770 Volts
Peak Positive Pulse Plate Voltage (Max.) .....	6500 Volts
Peak Negative Pulse Plate Voltage (Max.) .....	1500 Volts
DC Grid No. 3 Voltage (Max.) .....	70 Volts
DC Grid No. 2 Voltage (Max.) .....	220 Volts
DC Grid No. 1 Voltage (Max.) .....	55 Volts
Peak Negative Pulse Grid No. 1 Voltage .....	330 Volts
<b>Cathode Current</b>	
Peak (Max.).....	550 Ma
Average (Max.) .....	175 Ma
Grid No. 2 Input (Max.) .....	3.5 Watts
Plate Dissipation (Max.) <sup>(2)</sup> .....	17.5 Watts
Bulb Temperature (At Hottest Point) (Max.) .....	240 °C
Grid No. 1 Circuit Resistance	
For Grid-Resistor-Bias Operation (Max.) .....	1 Megohm

**CHARACTERISTICS AND TYPICAL OPERATION**

**Class A1 Amplifier**

Plate Voltage .....	250 Volts
Grid No. 3 Voltage .....	Connected to Cathode at Socket
Grid No. 2 Voltage .....	150 Volts
Grid No. 1 Voltage .....	-22.5 Volts
Amplification Factor .....	4.4
Plate Resistance (Approx.) .....	15,000 Ohms
Transconductance .....	7100 $\mu$ mhos
Plate Current .....	70 Ma
Grid No. 2 Current .....	2.1 Ma
Grid No. 1 Voltage for $I_b = 1$ Ma .....	-42 Volts

**INSTANTANEOUS PLATE KNEE VALUES**

$E_b = 60$  V,  $E_{c2} = 150$  V, and  $E_{c1} = 0$  V  
 $I_b = 390$  Ma and  $I_{c2} = 32$  Ma

**NOTES:**

- (1) For operation in a 525 line, 30 frame system as described in "Standards of Good Engineering Practice for Television Broadcast Stations; Federal Communications Commission," the duty cycle of the voltage pulse must not exceed 15% of one horizontal scanning cycle.
- (2) In stages operating with grid leak bias, an adequate cathode bias resistor or other suitable means is required to protect the tube in the absence of excitation.
- (3) Amplification factor with tube operating as a triode with 150 volts on the plate and Grid No. 2 and -22.5 volts on Grid No. 1.

# 6JT6A

12JT6A, 17JT6A

## HORIZONTAL DEFLECTION AMPLIFIER

**Beam Power Pentode**

Construction .....	Novar T-12
Base .....	Button 9 Pin, E9-88
Basing .....	.90U
Outline .....	.12-95
Maximum Diameter .....	1.563 In.
Maximum Seated Height .....	2.500 In.
Maximum Overall Height .....	2.880 In.

The Types 6JT6A, 12JT6A, and 17JT6A are identical to the Types 6JT6, 12JT6, and 17JT6 except for base with exhaust tip on bottom and shorter bulb.

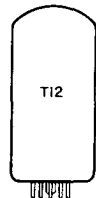
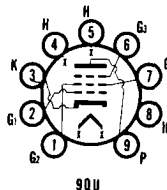



Color Television Type

**VOLTAGE AMP. or SYNC SEP. (T)  
VIDEO AMPLIFIER (P)**

**6JT8**

8JT8, 10JT8

**High Mu Triode and  
Sharp Cutoff Pentode**

Construction .....9T-9  
Base .....Button 9 Pin, E9-68  
Basing .....9DX  
Outline .....9-69  
Maximum Diameter .....1.188 In.  
Maximum Seated Height .....2.320 In.  
Maximum Overall Height .....2.630 In.

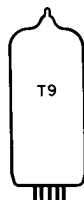
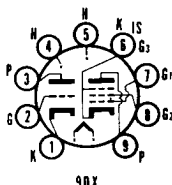

**ELECTRICAL DATA**

**HEATER OPERATION**

	10JT8	8JT8	6JT8
Heater Voltage.....	10.2	7.7	6.3 Volts
Heater Current.....	450	600	725 Ma
Heater Warm-up Time.....	11	11	— Seconds
Maximum Heater-Cathode Voltage			
Heater Negative with Respect to Cathode			
Total DC and Peak.....			200 Volts
Heater Positive with Respect to Cathode			
DC.....			100 Volts
Total DC and Peak.....			200 Volts

**DIRECT INTERELECTRODE CAPACITANCES (Unshielded)**

**Triode Section**

Grid to Plate.....	3.2 Pf
Input: g to (h + Tk + Pk, g3, IS).....	1.7 Pf
Output: p to (h + Tk + Pk, g3, IS).....	1.6 Pf

**Pentode Section**

Grid No. 1 to Plate (Max.).....	0.10 Pf
Input: g1 to (h + Pk, g3, IS + g2).....	12 Pf
Output: p to (h + Pk, g3, IS + g2).....	3.0 Pf

**Coupling**

Triode Grid to Pentode Plate (Max.).....	0.02 Pf
Pentode Grid No. 1 to Triode Plate (Max.).....	0.004 Pf
Pentode Plate to Triode Plate (Max.).....	0.13 Pf

**RATINGS (Design Maximum Rating System)**

	Triode Section	Pentode Section
Plate Voltage.....	330	330 Volts
Grid No. 2 Supply Voltage (Max.).....	—	330 Volts
Grid No. 2 Voltage.....	See Rating Chart (Gen. Info. Sec.)	
Positive Grid No. 1 Voltage (Max.).....	0	0 Volt
Plate Dissipation (Max.).....	1.0	4.0 Watts
Grid No. 2 Dissipation (Max.).....	—	1.1 Watts
Grid No. 1 Circuit Resistance		
Fixed Bias (Max.).....	0.5	0.25 Megohm
Cathode Bias (Max.).....	1.0	1.0 Megohm

Control grid to cathode spacing of the pentode section of this type is of such low order of magnitude as to preclude the use of voltage between these elements of more than 50 volts DC or peak AC in commercial tube checkers and shorts indicating devices, particularly where mechanical excitation of the tube is employed.

**CHARACTERISTICS AND TYPICAL OPERATION**

	Triode Section	Pentode Section
Plate Voltage.....	250	200 Volts
Grid No. 2 Voltage.....	—	100 Volts
Grid No. 1 Voltage.....	-2	0 Volts
Cathode Bias Resistor.....	—	82 Ohms
Plate Current.....	1.5	17 Ma
Grid No. 2 Current.....	—	3.5 Ma
Transconductance.....	2700	20,000 $\mu$ mhos
Amplification Factor.....	100	—
Plate Resistance (Approx.).....	37,000	50,000 Ohms
Ec1 for Ib = 100 $\mu$ a (Approx.).....	—	-5 Volts
Ec for Ib = 20 $\mu$ a (Approx.).....	-5.3	— Volts

**INSTANTANEOUS PLATE KNEE CHARACTERISTICS (Pentode Section)**

Eb = 50 V, Ec2 = 100 V and Ec1 = 0 V  
Ib = 55 Ma, and Ic2 = 18 Ma

**6JU6**

22JU6

**HORIZONTAL DEFLECTION  
AMPLIFIER****Beam Power Pentode**

Construction ..... Novar T-12  
 Base ..... Button 9 Pin, E9-76 or E9-88  
 Top Cap ..... C1-2, C1-33 or C1-3  
 Basing ..... 9QL

**Outline**

Maximum Diameter ..... 1.562 In.  
 Maximum Seated Height ..... 3.170 In.  
 Maximum Overall Height ..... 3.550 In.

**ELECTRICAL DATA****HEATER OPERATION**

	22JU6	6JU6
Heater Voltage.....	22.0	6.3 Volts
Heater Current .....	450	1600 Ma
Heater Warm-up Time .....	11	— Seconds
Maximum Heater-Cathode Voltage		
Heater Negative with Respect to Cathode		
Total DC and Peak.....		200 Volts
Heater Positive with Respect to Cathode		
DC .....		100 Volts
Total DC and Peak.....		200 Volts

**DIRECT INTERELECTRODE CAPACITANCES (Unshielded)**

Grid No. 1 to Plate .....	1.2 Pf
Input: g1 to (k, g3, g2, H).....	22 Pf
Output: p to (k, g3, g2, H).....	9.0 Pf

**RATINGS (Design Maximum Rating System)****Horizontal Deflection Amplifier**

DC Plate Supply Voltage (Max.).....	770 Volts
Peak Positive Pulse Plate Voltage (Max.) <sup>(4)</sup> .....	6500 Volts
Peak Negative Pulse Plate Voltage (Max.) .....	1500 Volts
DC Grid No. 3 Voltage <sup>(3)</sup> .....	75 Volts
DC Grid No. 2 Voltage.....	220 Volts
DC Grid No. 1 Voltage (Negative Bias Value).....	55 Volts
Peak Negative Pulse Grid No. 1 Voltage .....	330 Volts
Cathode Current	
Peak .....	950 Ma
Average .....	275 Ma
Grid No. 2 Input .....	3.5 Watts
Plate Dissipation <sup>(6)</sup> .....	17 Watts
Envelope Temperature (At Hottest Point).....	240 °C
Grid No. 1 Circuit Resistance	
Grid Bias Operation .....	0.47 Megohms
Plate Pulse Operation (Horizontal Deflection Circuit Only) .....	10 Megohms

**CHARACTERISTICS AND TYPICAL OPERATION**

Peak Positive Pulse Plate Voltage <sup>(4)</sup> .....	6500	—	—	— Volts
DC Plate Voltage.....	—	50	125	130 Volts
Grid No. 3 Voltage .....	Connected to Cathode at Socket			
DC Grid No. 2 Voltage.....	125	125	125	125 Volts
DC Grid No. 1 Voltage.....	—	0	-20	-20 Volts
Amplification Factor (Triode Connection) <sup>(1)</sup> .....	—	—	4.7	—
Plate Resistance (Approx.) .....	—	—	—	18 Kilohms
Transconductance .....	—	—	—	7000 $\mu$ mhos
DC Plate Current .....	—	470 <sup>(2)</sup>	—	45 Ma
DC Grid No. 2 Current .....	—	32 <sup>(2)</sup>	—	1.5 Ma
Cutoff DC Grid No. 1 Voltage for $I_b = 1$ Ma .....	-75	—	—	-32 Volts

**NOTES:**

- (1) With grid No. 2 connected to Plate at socket.
- (2) This value can be measured by a method involving a recurrent waveform such that the Maximum Ratings of the tube will not be exceeded.
- (3) Under pulse-duration condition specified in Footnote No. 4.
- (4) This rating is applicable where the duration of the voltage pulse do not exceed 15% of one horizontal scanning cycle. In a 525-line, 30-frame system, 15% of one horizontal scanning cycle is 10  $\mu$ s.
- (5) In horizontal deflection amplifier service, a positive voltage may be applied to Grid No. 3 to reduce interference from "Snivets" which may occur in both VHF and UHF television receivers. A typical operating value for this voltage is 30 V.
- (6) An adequate bias resistor or other suitable means is required to protect the tube in the absence of excitation.

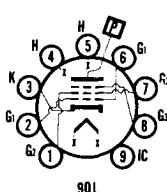

9QL

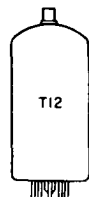

Color Television Type  
**PHASE DETECTOR COLOR KILLER**

**6JU8A**  
8JU8A

**Quadruple Diode**

Construction ..... Miniature T-6½  
Base ..... Button 9 Pin, E9-1  
Basing ..... 9PQ  
Outline ..... 6-2  
Maximum Diameter ..... 0.875 In.  
Maximum Seated Height ..... 1.937 In.  
Maximum Overall Height ..... 2.187 In.

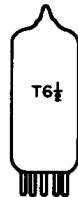
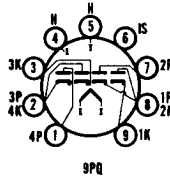

**ELECTRICAL DATA**  
**HEATER OPERATION**

Heater Voltage .....  
Heater Current .....  
Heater Warm-up Time .....  
Maximum Heater-Cathode Voltage

8JU8A	6JU8A
8.4	6.3 Volts
450	600 Ma
11	— Sec.

Heater Negative with Respect to Cathode ..... 300 Volts  
Heater Positive with Respect to Cathode ..... 300 Volts

**DIRECT INTERELECTRODE CAPACITANCES (Unshielded)**

K (Unit 1) to P (Unit 1) and K (Unit 2) ..... 1.8 Pf  
P (Unit 2) to P (Unit 1) and K (Unit 2) ..... 2.2 Pf  
P (Unit 2) to Heater and IS ..... 0.62 Pf  
K (Unit 3) to P (Unit 3) and K (Unit 4) ..... 1.9 Pf  
P (Unit 4) to P (Unit 3) and K (Unit 4) ..... 2.2 Pf  
P (Unit 4) to Heater and IS ..... 0.94 Pf  
K (Unit 1) to Heater and IS ..... 1.8 Pf  
K (Unit 3) to Heater and IS ..... 1.9 Pf

**RATINGS (Design Maximum Rating System) (Each Section)**

Peak Inverse Plate Voltage (Max.) ..... 300 Volts  
DC Output Current (Max.) ..... 9 Ma  
Peak Plate Current (Max.) ..... 54 Ma

**CHARACTERISTICS AND TYPICAL OPERATION**

Plate Current at Eb = 10 Volts ..... 60 Ma

Color Television Type  
**VOLTAGE AMP. or SYNC SEP. (T)**  
**VIDEO AMPLIFIER (P)**

**6JV8**  
8JV8,

**High Mu Triode and Sharp Cutoff Pentode**

Construction ..... Miniature T-6½  
Base ..... Button 9 Pin, E9-1  
Basing ..... 9DX  
Outline ..... 6-3  
Maximum Diameter ..... 0.875 In.  
Maximum Seated Height ..... 2.375 In.  
Maximum Overall Height ..... 2.625 In.

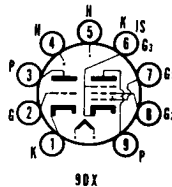

**ELECTRICAL DATA**  
**HEATER OPERATION**

Heater Voltage .....  
Heater Current .....  
Heater Warm-up Time .....  
Maximum Heater-Cathode Voltage

8JV8	6JV8
8.5	6.3 Volts
450	600 Ma
11	11 Seconds

Heater Negative with Respect to Cathode  
Total DC and Peak ..... 200 Volts  
Heater Positive with Respect to Cathode  
DC ..... 100 Volts  
Total DC and Peak ..... 200 Volts

**DIRECT INTERELECTRODE CAPACITANCES (Unshielded)**

**Triode Section**

Grid to Plate ..... 2.2 Pf  
Input: g to (h + k) ..... 3 Pf  
Output: p to (h + k) ..... 2 Pf

**Pentode Section**

Grid No. 1 to Plate (Max.).....	0.08 Pf
Input: $g_1$ to $(h + k + g_2 + g_3 + IS)$ .....	8 Pf
Output: $p$ to $(h + k + g_2 + g_3 + IS)$ .....	3.2 Pf

**Coupling**

Pentode Grid No. 1 to Triode Plate (Max.) .....	0.012 Pf
Pentode Plate to Triode Plate (Max.) .....	0.24 Pf

**RATINGS (Design Maximum Rating System)**

	<b>Triode Section</b>	<b>Pentode Section</b>
Plate Voltage (Max.) .....	300	330 Volts
Grid No. 2 Supply Voltage (Max.) .....	—	330 Volts
Grid No. 2 Voltage .....	See Rating Chart (Gen. Info. Sec.)	
Plate Dissipation (Max.) .....	1.1	4 Watts
Grid No. 2 Dissipation (Max.) .....	—	1.7 Watts
Positive Grid No. 1 Voltage (Max.) .....	0	0 Volt
Grid No. 1 Circuit Resistance		
Fixed Bias (Max.) .....	0.5	0.25 Megohm
Self Bias (Max.) .....	1.0	1.0 Megohm

**CHARACTERISTICS AND TYPICAL OPERATION**

	<b>Triode Section</b>	<b>Pentode Section</b>	
<b>Class A1 Amplifier</b>			
Plate Voltage .....	200	200	125 Volts
Grid No. 2 Voltage .....	—	200	125 Volts
Grid No. 1 Voltage .....	-2	-2.9	-1 Volts
Plate Current .....	4	22	22 Ma
Grid No. 2 Current .....	—	4.0	4 Ma
Transconductance .....	4000	10,700	11,500 $\mu$ mhos
Amplification Factor .....	70	—	—
Plate Resistance (Approx.) .....	17,500	150,000	100,000 Ohms
$E_{c1}$ for $I_b = 20 \mu a$ (Approx.).....	-5	-9	-5.5 Volts

**INSTANTANEOUS PLATE KNEE CHARACTERISTICS**

$E_b = 60$  V;  $E_{c2} = 200$  V and  $E_{c1} = 0$  V  
 $I_b = 51$  Ma (Approx.) and  $I_{c2} = 14$  Ma (Approx.)

**6JW8/ECF802**  
9JW8

Color Television Type  
**HORIZONTAL OSCILLATOR (P)  
REACTANCE TUBE (T)**

**Triode and Pentode**

Construction ..... Miniature T-6½  
 Base ..... Button 9 Pin, E9-1  
 Basing ..... 9DC  
 Outline ..... 6-2  
 Maximum Diameter ..... 0.875 In.  
 Maximum Seated Height ..... 1.937 In.  
 Maximum Overall Height ..... 2.187 In.

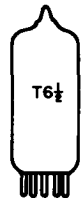
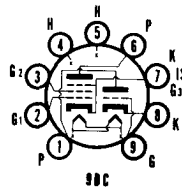

**ELECTRICAL DATA  
HEATER OPERATION**

	<b>9JW8</b>	<b>6JW8/ECF802</b>
Heater Voltage.....	9.3	6.3 Volts
Heater Current .....	450	430 Ma
Maximum Heater-Cathode Voltage .....	100	100 Volts

**DIRECT INTERELECTRODE CAPACITANCES**

**Pentode Section**

Grid No. 1 .....	5.4 Pf
Plate to Grid No. 1 .....	0.060 Pf
Grid No. 1 to Filament .....	0.1 Pf

**Triode Section**

Grid.....	2.4 Pf
Plate to Grid .....	1.5 Pf
Grid to Filament .....	0.1 Pf

**RATINGS (Design Center Rating System)**

**Pentode Section**

Plate Voltage, Zero Plate Current (Max.) .....	550 Volts
Plate Voltage (Max.) .....	250 Volts
Plate Dissipation (Max.) .....	1.2 Watts
Grid No. 2 Voltage, Zero Plate Current (Max.) .....	550 Volts
Grid No. 2 Voltage (Max.) .....	250 Volts
Grid No. 2 Dissipation (Max.) .....	0.8 Watt

Grid No. 1 Circuit Resistance (Fixed Bias) (Max.) .....	0.56 Megohm
Grid No. 1 Circuit Resistance (Self Bias) (Max.) .....	1.0 Megohm
Cathode Current (Max.) .....	15 Ma
Peak Cathode Current (Max.) <sup>(1)</sup> .....	50 Ma
Input Impedance at 60 Hertz (Max.) .....	300 K Ohms
<b>Triode Section</b>	
Plate Voltage, Zero Plate Current (Max.) .....	550 Volts
Plate Voltage (Max.) .....	250 Volts
Plate Dissipation (Max.) .....	1.4 Watts
Grid No. 1 Circuit Resistance (Max.) .....	3 Megohms
Cathode Current (Max.) .....	10 Ma
Input Impedance at 60 Hertz (Max.) .....	50 K Ohms

**CHARACTERISTICS AND TYPICAL OPERATION**

**Pentode Section**

Plate Voltage .....	100 Volts
Grid No. 2 Voltage .....	100 Volts
Grid No. 1 Voltage .....	-1 Volt
Plate Current .....	6 Ma
Grid No. 2 Current .....	1.7 Ma
Transconductance .....	5500 $\mu$ ms
Input Resistance .....	0.4 Megohm
Amplification Factor (Grid No. 1 to Grid No. 2) .....	47
Plate Current ( $E_{g1} = 0$ V) .....	12.5 Ma
Grid No. 2 Current ( $E_{g1} = 0$ V) .....	3.5 Ma
Grid No. 1 Voltage ( $E_b = E_{g2} = 200$ V, $I_b = 10$ $\mu$ a) .....	-16 Volts
Grid No. 1 Voltage ( $I_{c1} = +0.3$ $\mu$ a) .....	-1.3 Volts

**Triode Section**

Plate Voltage .....	200 Volts
Grid Voltage .....	-2 Volts
Plate Current .....	3.5 Ma
Transconductance .....	3500 $\mu$ ms
Input Resistance .....	20 K Ohms
Amplification Factor .....	70
Plate Current ( $I_c = 10$ $\mu$ a) .....	10 Ma
Grid Voltage ( $I_c = +0.3$ $\mu$ a) .....	-1.3 Volts

**NOTE:**

(1) Duty cycle 30% maximum; pulse time 30  $\mu$ sec. maximum.

**HORIZONTAL DEFLECTION  
AMPLIFIER**

**6JZ6**

21JZ6

**Beam Power Pentode**

Construction .....	Compactron T-12
Base .....	Button 12 Pin, E12-74
Top Cap .....	C1-3
Basing .....	12GD
Outline .....	12-79
Maximum Diameter .....	1.563 In.
Maximum Seated Height .....	3.250 In.
Maximum Overall Height .....	3.625 In.

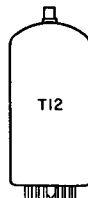
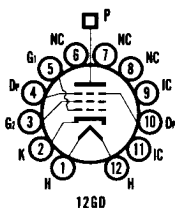

**ELECTRICAL DATA**

**HEATER OPERATION**

Heater Voltage .....	21JZ6 21.0	6JZ6 6.3 Volts
Heater Current .....	450	1500 Ma
Heater Warm-up Time .....	11	— Sec.
Maximum Heater-Cathode Voltage		
Heater Negative with Respect to Cathode		
Total DC and Peak .....		200 Volts
Heater Positive with Respect to Cathode		
DC .....		100 Volts
Total DC and Peak .....		200 Volts

**DIRECT INTERELECTRODE CAPACITANCES (Unshielded)**

Grid No. 1 to Plate .....	0.34 Pf
Input: $g_1$ to ( $h + k + g_2 + b.p.$ ) .....	24 Pf
Output: $p$ to ( $h + k + g_2 + b.p.$ ) .....	8.5 Pf

**RATINGS (Design Maximum Rating System)**

**Horizontal Deflection Amplifier Service<sup>(1)</sup>**

DC Plate Supply Voltage (Boost + DC Power Supply) (Max.) .....	770 Volts
Peak Positive Pulse Plate Voltage (Max.) .....	6500 Volts
Peak Negative Pulse Plate Voltage (Max.) .....	1500 Volts
Positive DC Beam Plate Voltage (Max.) .....	70 Volts

Screen Voltage (Max.) .....	220 Volts
Negative DC Grid No. 1 Voltage (Max.) .....	55 Volts
Peak Negative Grid No. 1 Voltage (Max.) .....	330 Volts
Plate Dissipation (Max.) <sup>(2)</sup> .....	18 Watts
Screen Dissipation (Max.) .....	3.5 Watts
DC Cathode Current (Max.) .....	230 Ma
Peak Cathode Current (Max.) .....	800 Ma
Grid No. 1 Circuit Resistance (Max.) .....	1.0 Megohm
Bulb Temperature at Hottest Point (Max.) .....	220 °C

**CHARACTERISTICS AND TYPICAL OPERATION**

Plate Voltage .....	5000	50	130 Volts
Beam Plates .....	Connected	to Cathode at Socket	
Screen Voltage .....	130	130	130 Volts
Grid No. 1 Voltage .....	—	0 <sup>(3)</sup>	-20 Volts
Plate Resistance (Approx.) .....	—	—	9900 Ohms
Transconductance .....	—	—	9000 μmhos
Plate Current .....	—	450	46 Ma
Screen Current .....	—	29	1.8 Ma
Grid No. 1 Voltage (Approx.) Ib = 1.0 Ma .....	-64	—	-32 Volts
Triode Amplification Factor <sup>(4)</sup> .....	—	—	4.8

**NOTES:**

- (1) For operation in a 525 line, 30 frame system as described in "Standards of Good Engineering Practice for Television Broadcast Stations; Federal Communications Commission," the duty cycle of the voltage pulse must not exceed 15% of one horizontal scanning cycle.
- (2) In stages operating with grid-leak bias, an adequate cathode bias resistor of other suitable means is required to protect the tube in the absence of excitation.
- (3) Applied for short interval (two seconds maximum) so as not to damage tube.
- (4) Triode connection (screen tied to plate) with Eb = Ec2 = 130 V and Ec1 = -20 V.

# 6JZ8

13JZ8, 17JZ8,  
24JZ8, 25JZ8

## VERTICAL DEFLECTION OSCILLATOR and AMPLIFIER

**Medium Mu Triode and Sharp Cutoff Pentode**

Construction .....	Compactron T-9
Base .....	Button 12 Pin, E12-70
Basing .....	12DZ
Outline .....	9-58
Maximum Diameter .....	1.188 In.
Maximum Seated Height .....	2.000 In.
Maximum Overall Height .....	2.375 In.

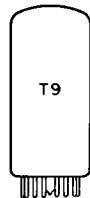
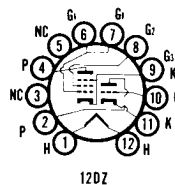

**ELECTRICAL DATA**

**HEATER OPERATION**

	25JZ8	24JZ8	13JZ8	17JZ8	6JZ8
Heater Voltage .....	25.2	24.2	12.7	17.5	6.3
Heater Current .....	300	315	600	450	1200 Ma
Heater Warm-up Time .....	11	11	11	11	— Seconds
Maximum Heater-Cathode Voltage					
Heater Negative with Respect to Cathode					
Total DC and Peak .....					200 Volts
Heater Positive with Respect to Cathode					
DC .....					100 Volts
Total DC and Peak .....					200 Volts

**DIRECT INTERELECTRODE CAPACITANCES (Unshielded)**

**Triode Section**

Grid to Plate .....	3.6 Pf
Input: g to (h + Tk) .....	2.2 Pf
Output: p to (h + Tk) .....	0.7 Pf

**Pentode Section**

Grid No. 1 to Plate (Max.) .....	0.34 Pf
Input: g1 to (h + Pk + Pp + g2) .....	11 Pf
Output: p to (h + Pk + Pp + g2) .....	7 Pf

**RATINGS (Design Maximum Rating System)  
Vertical Deflection Oscillator and Amplifier<sup>(1)</sup>**

	Tri. Osc.	Pent. Amp.
Plate Voltage (Max.) .....	250	250 Volts
Grid No. 2 Voltage (Max.) .....	—	200 Volts
Peak Positive Pulse Plate Voltage (Max.) .....	—	2000 Volts
Peak Negative Grid No. 1 Voltage (Max.) .....	400	150 Volts
Plate Dissipation (Max.) <sup>(2)</sup> .....	1.0	7 Watts
Grid No. 2 Dissipation (Max.) <sup>(2)</sup> .....	—	1.8 Watts
Average Cathode Current (Max.) .....	20	70 Ma
Peak Cathode Current (Max.) .....	70	245 Ma
Grid Circuit Resistance		
Self Bias (Max.) .....	2.2	2.2 Megohms
Fixed Bias (Max.) .....	1.0	1.0 Megohm

**CHARACTERISTICS AND TYPICAL OPERATION**

	Triode Section	Pentode Section
Plate Voltage .....	150	120 Volts
Grid No. 2 Voltage .....	—	110 Volts
Grid No. 1 Voltage .....	-5	-8 Volts
Plate Current .....	5.5	46 Ma
Grid No. 2 Current .....	—	3.5 Ma
Transconductance .....	2350	7100 $\mu$ mhos
Amplification Factor .....	20	—
Plate Resistance (Approx.) .....	8500	11,700 Ohms
Ec for Ib = 10 $\mu$ a (Approx.) .....	-11	— Volts
Ec for Ib = 100 $\mu$ a (Approx.) .....	—	-25 Volts

**INSTANTANEOUS PLATE KNEE VALUES**

Eb = 45 V; Ec2 = 110 V; and Ec = 0 V  
Ib = 122 Ma, and Ic2 = 16.5 Ma

**NOTES:**

- (1) For operation in a 525 line, 30 frame system as described in "Standards of Good Engineering Practice for Television Broadcast Stations; Federal Communications Commission," the duty cycle of the voltage pulse must not exceed 15% of one horizontal scanning cycle.
- (2) In stages operating with grid leak bias, an adequate bias resistor or other suitable means is required to protect the tube in the absence of excitation.

**AVERAGE PLATE CHARACTERISTICS  
(Pentode Section)**

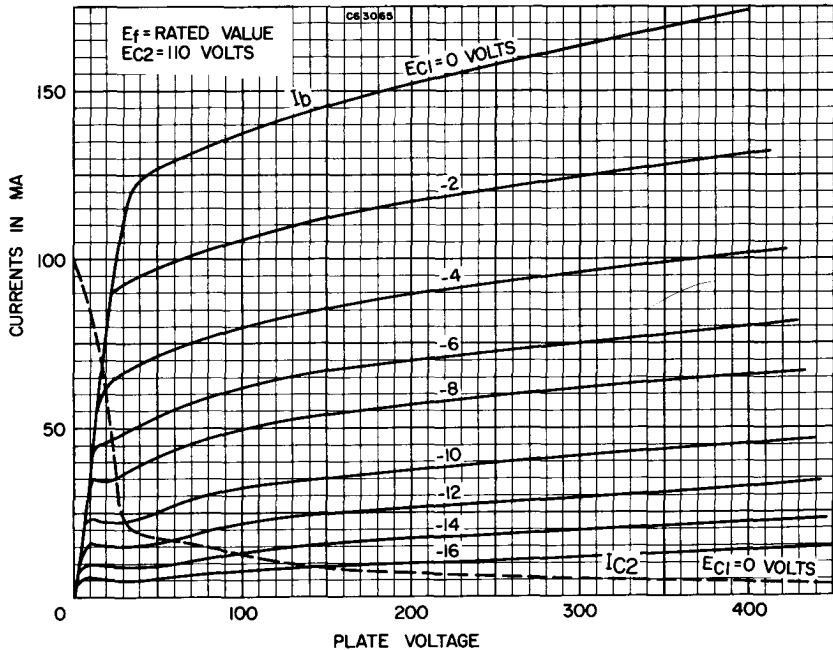

**AVERAGE PLATE CHARACTERISTICS  
(Triode Section)**

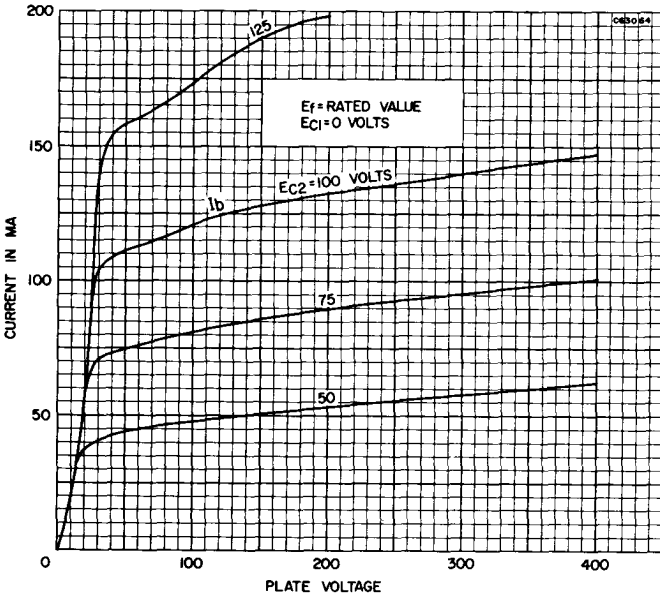

**6K6GT**

**AUDIO POWER AMPLIFIER**

**Power Pentode**

- Construction .....Octal T-9
- Base .....Octal 6 or 7 Pin
- Basing .....7S
- Outline .....9-11 or 9-41
- Maximum Diameter .....1.188 In.
- Maximum Seated Height .....2.750 In.
- Maximum Overall Height .....3.313 In.

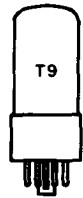
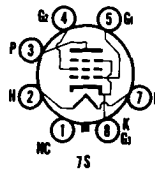

**ELECTRICAL DATA  
HEATER OPERATION**

Heater Voltage.....	6.3 Volts
Heater Current .....	400 Ma
Maximum Heater-Cathode Voltage	
Heater Negative with Respect to Cathode	
Total DC and Peak.....	200 Volts
Heater Positive with Respect to Cathode	
DC .....	100 Volts
Total DC and Peak.....	200 Volts

**DIRECT INTERELECTRODE CAPACITANCES (Unshielded)**

Control Grid to Plate.....	0.5 Pf
Input .....	5.5 Pf
Output .....	6.0 Pf

**RATINGS (Design Center Rating System)**

Plate Voltage (Max.) .....	315 Volts
Plate Dissipation (Max.) .....	8.5 Watts
Screen Voltage (Max.) .....	285 Volts
Screen Dissipation (Max.) .....	2.8 Watts
Positive Control Grid Voltage (Max.) .....	0 Volt



**CHARACTERISTICS AND TYPICAL OPERATION**

Plate Voltage .....	100	250	315 Volts
Screen Voltage .....	100	250	250 Volts
Control Grid Bias Voltage <sup>(1)</sup> .....	-7	-18	-21 Volts
Peak AF Grid Voltage .....	7	18	21 Volts
Zero Signal Plate Current .....	9	32	25.5 Ma
Zero Signal Screen Current .....	1.6	5.5	4.0 Ma
Maximum Signal Plate Current .....	9.5	33	28 Ma
Maximum Signal Screen Current .....	3	10	9 Ma
Transconductance .....	1500	2300	2100 $\mu$ mhos
Plate Resistance (Approx.) .....	104,000	90,000	110,000 Ohms
Load Resistance .....	12,000	7600	9000 Ohms
Power Output .....	0.35	3.4	4.5 Watts
Total Harmonic Distortion .....	11	11	15 Percent

**Push-Pull Class A1 Amplifier (Values for Two Tubes)**

	Fixed Bias	Self Bias
Plate Voltage .....	285	285 Volts
Screen Voltage .....	285	285 Volts
Control Grid Bias Voltage <sup>(1)</sup> .....	-25.5	— Volts
Cathode Bias Resistor .....	—	400 Ohms
Peak AF Grid to Grid Voltage .....	51	51 Volts
Zero Signal Plate Current .....	55	55 Ma
Zero Signal Screen Current .....	9	9 Ma
Maximum Signal Plate Current .....	72	61 Ma
Maximum Signal Screen Current .....	17	13 Ma
Load Resistance (Plate to Plate) .....	12,000	12,000 Ohms
Maximum Signal Power Output .....	10.5	9.8 Watts
Total Harmonic Distortion .....	6	4 Percent

**NOTE:**

(1) The DC resistance in the grid circuit under rated maximum conditions should not exceed 0.5 megohm for self-bias operation, and 0.1 megohm for fixed-bias operation.

**AGC, SYNC CLIPPER  
and NOISE INVERTER**

**6K11/6Q11**

**Two High Mu Triodes and  
One Medium Mu Triode**

Construction.....Compactron T-9  
 Base .....Button 12 Pin, E12-70  
 Basing .....12BY  
 Outline .....9-56  
 Maximum Diameter .....1.188 In.  
 Maximum Seated Height .....1.500 In.  
 Maximum Overall Height .....1.846 In.

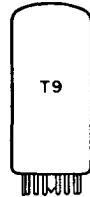
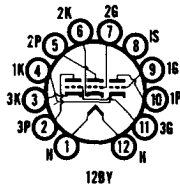

**ELECTRICAL DATA**

**HEATER OPERATION**

Heater Voltage.....	6.3 Volts
Heater Current.....	600 Ma
Heater Warm-up Time.....	11 Seconds
Maximum Heater-Cathode Voltage	
Heater Negative with Respect to Cathode	
Total DC and Peak.....	200 Volts
Heater Positive with Respect to Cathode	
DC.....	100 Volts
Total DC and Peak.....	200 Volts

**DIRECT INTERELECTRODE CAPACITANCES (Unshielded)**

	Section No. 1	Section No. 2	Section No. 3
Grid to Plate .....	1.3	1.3	1.3 Pf
Input: g to (h + k + IS) .....	1.9	1.8	1.8 Pf
Output: p to (h + k + IS) .....	1.8	0.7	1.8 Pf

**RATINGS (Design Maximum Rating System)**

	Section No. 1	Section No. 2 and No. 3
Plate Voltage (Max.) .....	330	330 Volts
Plate Dissipation (Max.) .....	2.75	0.3 Watts
Cathode Current (Max.).....	20	— Ma
Positive Grid Voltage (Max.) .....	0	0 Volt
Negative Grid Voltage (Max.) .....	50	50 Volts

**CHARACTERISTICS AND TYPICAL OPERATION**

**Class A1 Amplifier**

	Section No. 1	Section No. 2 and No. 3
Plate Voltage .....	250	250 Volts
Grid Voltage .....	-8.5	-2.0 Volts
Plate Current .....	10.5	1.2 Ma
Plate Resistance .....	7700	62,500 Ohms
Transconductance .....	2200	1600 $\mu$ mhos
Amplification Factor .....	17	100
Ec for Ib = 10 $\mu$ a .....	-24	— Volts



**High Mu Triode and Sharp Cutoff Pentode**

- Construction ..... Miniature T-6½
- Base ..... Button 9 Pin, E9-1
- Basing ..... 9PV
- Outline ..... 6-3
- Maximum Diameter ..... 0.875 In.
- Maximum Seated Height ..... 2.375 In.
- Maximum Overall Height ..... 2.625 In.

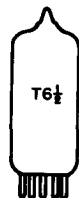
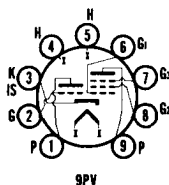

**ELECTRICAL DATA**  
**HEATER OPERATION**

	8KA8	6KA8
Heater Voltage .....	8.4	6.3 Volts
Heater Current .....	450	600 Ma
Heater Warm-up Time .....	11	11 Seconds
Maximum Heater-Cathode Voltage		
Heater Negative with Respect to Cathode		
Total DC and Peak .....		200 Volts
Heater Positive with Respect to Cathode		
DC .....		100 Volts
Total DC and Peak .....		200 Volts

**DIRECT INTERELECTRODE CAPACITANCES (Unshielded)**

**Triode Section**

Grid to Plate .....	2.2 Pf
Input: g to (k + h + IS) .....	2.8 Pf
Output: p to (k + h + IS) .....	2.2 Pf

**Pentode Section**

Grid No. 1 to Plate (Max.) .....	0.1 Pf
Input: g1 to (h + k + g2 + g3 + IS) .....	9.5 Pf
Grid No. 3 to (h + k + g2 + g1 + IS) .....	7 Pf
Grid No. 1 to Grid No. 3 .....	0.5 Pf
Grid No. 3 to Plate .....	2.2 Pf

**RATINGS (Design Maximum Rating System)**

	Triode Section	Pentode Section
Plate Voltage (Max.) .....	300	300 Volts
Peak Positive Pulse Plate Voltage (Max.) <sup>(1)</sup> .....	—	600 Volts
Grid No. 2 Supply Voltage (Max.) .....	—	300 Volts
Grid No. 2 Voltage .....	See Rating Chart (Gen. Info. Sec.)	
Positive Grid No. 3 Voltage (Max.) .....	—	0 Volt
Negative Grid No. 3 Voltage (Max.) .....	—	100 Volts
Positive Grid No. 1 Voltage (Max.) .....	0	0 Volt
Negative Grid No. 1 Voltage (Max.) .....	50	50 Volts
Plate Dissipation (Max.) .....	1.1	2.0 Watts
Grid No. 2 Input (Max.) .....	—	1.1 Watt
Grid No. 1 Circuit Resistance		
Self Bias (Max.) .....	1.0	1.0 Megohm
Fixed Bias (Max.) .....	0.25	0.5 Megohm
Grid No. 3 Circuit Resistance (Max.) .....	—	0.68 Megohm

**CHARACTERISTICS AND TYPICAL OPERATION**

**Class A1 Amplifier**

	Triode Section	Pentode Section
Plate Supply Voltage .....	200	150 Volts
Grid No. 2 Voltage .....	—	100 Volts

Grid No. 1 Voltage .....	-2	0 Volts
Cathode Bias Resistor .....	—	180 Ohms
Plate Current .....	4	4 Ma
Grid No. 2 Current .....	—	2.8 Ma
Amplification Factor .....	70	—
Plate Resistance (Approx.) .....	17,500	100,000 Ohms
Transconductance (G1 to P) .....	4000	4400 $\mu$ hos
Transconductance (G3 to P) .....	—	600 $\mu$ hos
Ec3 for Ib = 20 $\mu$ a (Approx.) .....	—	-7 Volts
Ec1 for Ib = 10 $\mu$ a (Approx.) .....	-5	— Volts
20 $\mu$ a (Approx.) .....	—	-4 Volts

**NOTE:**

- (1) The duration of the voltage pulse must not exceed 15% of one horizontal scanning cycle. In a 525-line, 30-frame system, 15% of one horizontal scanning cycle is 10  $\mu$ sec.

**AVERAGE PLATE CHARACTERISTICS  
(Pentode Section)**

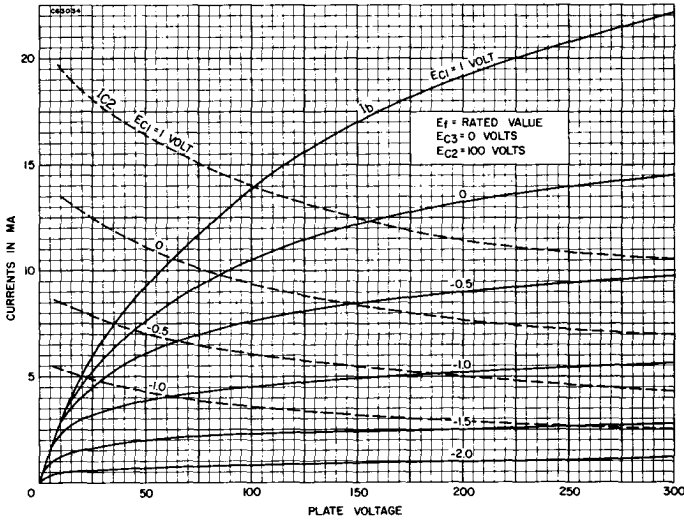

**AVERAGE PLATE CHARACTERISTICS  
(Triode Section)**

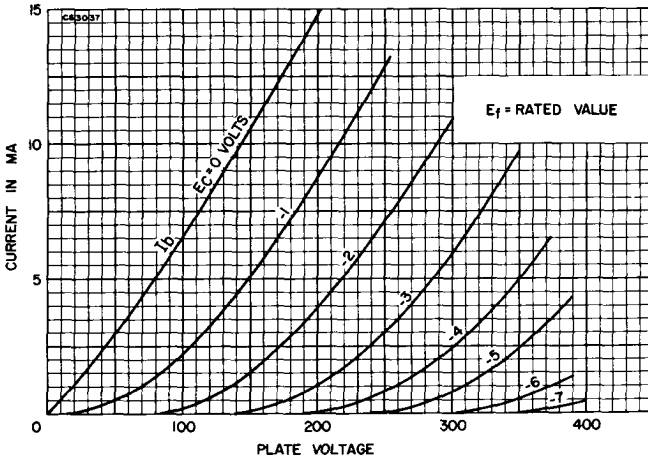

**6KD6**

30KD6, 36KD6, 40KD6

Color Television Type

**HORIZONTAL DEFLECTION  
AMPLIFIER****Beam Power Pentode**

Construction.....Compactron T-12  
 Base .....Button 12 Pin, E12-74  
 Top Cap .....C1-2  
 Basing<sup>(1)</sup> .....12GW  
 Outline .....12-118  
 Maximum Diameter .....1.563 In.  
 Maximum Seated Height .....4.250 In.  
 Maximum Overall Height .....4.625 In.

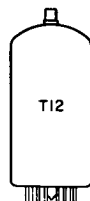
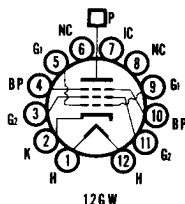
**ELECTRICAL DATA****HEATER OPERATION**

	40KD6	36KD6	30KD6	6KD6
Heater Voltage.....	40	36	30	6.3 Volts
Heater Current .....	450	450	600	2850 Ma
Heater Warm-up Time .....	11	11	11	— Seconds
Maximum Heater-Cathode Voltage				
Heater Negative with Respect to Cathode				
Total DC and Peak.....				200 Volts
Heater Positive with Respect to Cathode				
DC .....				100 Volts
Total DC and Peak.....				200 Volts

**DIRECT INTERELECTRODE CAPACITANCES (Unshielded)**

Grid to Plate .....	0.8 Pf
Input: g1 to (h + k + g2 + bp).....	40 Pf
Output: p to (h + k + g2 + bp).....	16 Pf

**RATINGS (Design Maximum Rating System)****Horizontal Deflection Amplifier<sup>(2)</sup>**

DC Plate Supply Voltage (Boost + DC Power Supply) (Max.) .....	990 Volts
Peak Positive Plate Voltage (Max.) .....	7000 Volts
Peak Negative Plate Voltage (Max.) .....	1100 Volts
Beam Plate Voltage (Max.) .....	20 Volts
Grid No. 2 Voltage (Max.) .....	200 Volts
Peak Negative Grid No. 1 Voltage (Max.) .....	250 Volts
Plate Dissipation (Max.) <sup>(3)</sup> .....	33 Watts
Grid No. 2 Dissipation (Max.) .....	5.0 Watts
Average Cathode Current (Max.) .....	400 Ma
Peak Cathode Current (Max.) .....	1400 Ma
Grid No. 1 Circuit Resistance (Max.) <sup>(3)</sup> .....	2.2 Megohm
Bulb Temperature (At Hottest Point) (Max.) .....	225 °C

**CHARACTERISTICS AND TYPICAL OPERATION**

Plate Voltage .....	150 Volts
Grid No. 2 Voltage .....	110 Volts
Grid No. 1 Voltage .....	-22.5 Volts
Beam Plate Voltage .....	Tied to Cathode
Plate Current .....	100 Ma
Grid No. 2 Current .....	2.0 Ma
Transconductance .....	14,000 $\mu$ mhos
Amplification Factor <sup>(4)</sup> .....	4.0
Plate Resistance.....	6000 Ohms
Ec1 for Ib = 1 Ma (Approx.).....	-40 Volts

**INSTANTANEOUS PLATE KNEE VALUES**

Eb = 60 V, Ec2 = 100 V and Ec1 = 0 V;  
 Ib = 750 Ma; and Ic2 = 42 Ma

**NOTES:**

- (1) Pins designated Internal Connection (IC) may or may not be connected to an internal element, depending on manufacturer. To maintain interchangeability, these pins should not be used as tie points.
- (2) For operation in a 525 line, 30 frame system as described in "Standards of Good Engineering Practice for Television Broadcast Stations; Federal Communications Commission," the duty cycle of the voltage pulse must not exceed 15% of one horizontal scanning cycle.
- (3) In stages operating with grid leak bias, an adequate bias resistor or other suitable means is required to protect the tube in the absence of excitation.
- (4) Amplification factor with tube operating as a triode with 150 volts on the plate and Grid No. 2 and -22.5 volts on Grid No. 1.

Color Television Type

## VHF OSCILLATOR and MIXER

# 6KE8

5KE8, 4KE8

**Medium Mu Triode and Sharp Cutoff Pentode**

Construction ..... Miniature T-6½  
 Base ..... Button 9 Pin, E9-1  
 Basing ..... 9DC  
 Outline ..... 6-2  
 Maximum Diameter ..... 0.875 In.  
 Maximum Seated Height ..... 1.937 In.  
 Maximum Overall Height ..... 2.187 In.

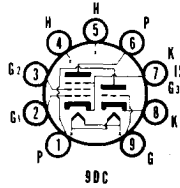

**ELECTRICAL DATA**  
**HEATER OPERATION**

	4KE8	5KE8	6KE8
Heater Voltage.....	4.5	5.6	6.3 Volts
Heater Current.....	600	450	400 Ma
Heater Warm-up Time .....	11	11	— Seconds
Maximum Heater-Cathode Voltage			
Heater Negative with Respect to Cathode			200 Volts
Total DC and Peak.....			
Heater Positive with Respect to Cathode			100 Volts
DC .....			200 Volts
Total DC and Peak.....			

**DIRECT INTERELECTRODE CAPACITANCES (Shielded)**

**Triode Section**

Grid to Plate .....	1.3 Pf
Input: g1 to (k + Pk + Pg3 + IS + h) .....	2.4 Pf
Output: p to (Tk + Pk + Pg3 + IS + h) .....	2.0 Pf

**Pentode Section**

Grid No. 1 to Plate (Max.).....	0.015 Pt
Input: g1 to (k + g3 + IS + g2 + h).....	5.0 Pf
Output: p to (k + g3 + IS + g2 + h).....	3.4 Pf

**RATINGS (Design Maximum Rating System)**

	Triode Section	Pentode Section
Plate Voltage (Max.) .....	280	280 Volts
Grid No. 2 Supply Voltage (Max.) .....	—	280 Volts
Grid No. 2 Voltage .....	See Rating Chart (Gen. Info. Sec.)	
Cathode Current (Max.).....	20	20 Ma
Plate Dissipation (Max.) .....	2.0	2.0 Watts
Grid No. 2 Dissipation (Max.) .....	—	0.5 Watt
Positive Grid No. 1 Voltage (Max.) .....	0	0 Volt

**AVERAGE PLATE CHARACTERISTICS**  
**(Pentode Section)**

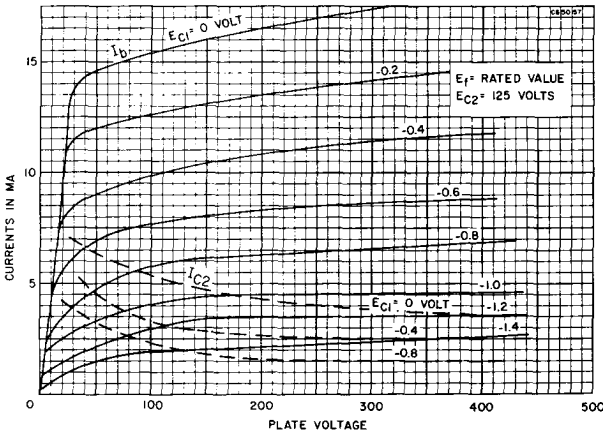

**AVERAGE PLATE CHARACTERISTICS  
(Triode Section)**

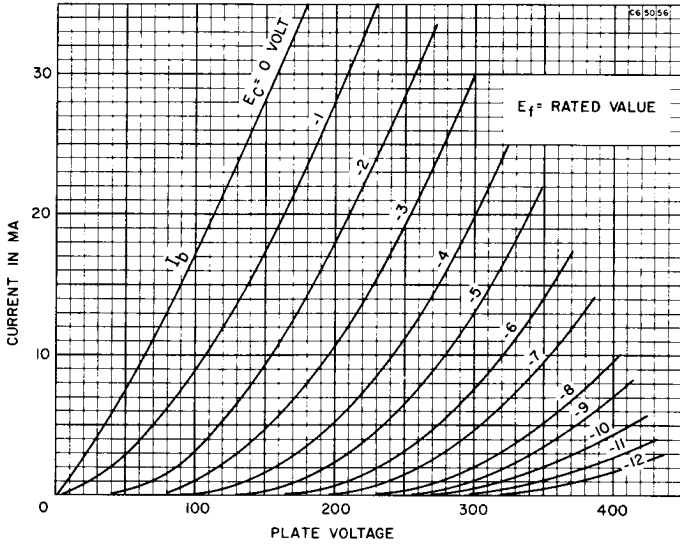

**CHARACTERISTICS AND TYPICAL OPERATION  
Class A1 Amplifier**

	Triode Section	Pentode Section
Plate Voltage .....	125	125 Volts
Grid No. 2 Voltage .....	—	125 Volts
Grid No. 1 Voltage .....	0	0 Volt
Cathode Bias Resistor .....	68	33 Ohms
Plate Current .....	13	10 Ma
Grid No. 2 Current .....	—	2.8 Ma
Transconductance .....	8000	12,000 $\mu$ mhos
Amplification Factor .....	40	—
Plate Resistance (Approx.) .....	5000	125,000 Ohms
$E_{c1}$ for $I_b = 100 \mu a$ (Approx.) .....	-5	— Volts
$E_{c1}$ for $I_b = 50 \mu a$ (Approx.) .....	—	-3 Volts

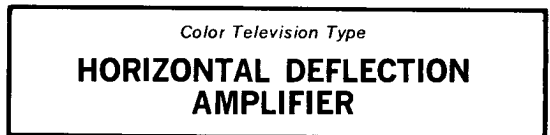

**Beam Power Pentode**

- Construction ..... Novar T-12
- Base ..... Button 9 Pin, E9-88 or E9-76
- Top Cap ..... C1-2, C1-33 or C1-3
- Basing<sup>(4)</sup> ..... 9QL
- Outline ..... 12-70
- Maximum Diameter ..... 1.562 In.
- Maximum Seated Height ..... 3.170 In.
- Maximum Overall Height ..... 3.550 In.

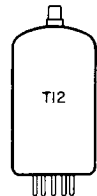
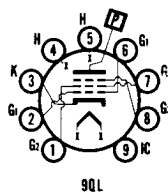

**ELECTRICAL DATA  
HEATER OPERATION**

Heater Voltage .....	22.0	6.3 Volts
Heater Current .....	450	1600 Ma
Heater Warm-up Time .....	11	— Seconds
Maximum Heater-Cathode Voltage Heater Negative with Respect to Cathode Total DC and Peak .....		200 Volts

Heater Positive with Respect to Cathode

DC .....	100 Volts
Total DC and Peak .....	200 Volts

**DIRECT INTERELECTRODE CAPACITANCES (Unshielded)**

Grid to Plate .....	1.2 Pf
Input .....	22.0 Pf
Output .....	9.0 Pf

**RATINGS (Design Maximum Rating System)**

**Horizontal Deflection Amplifier<sup>(1)</sup> (Sections in Parallel)**

DC Plate Supply Voltage (Boost + DC Power Supply) (Max.) .....	770 Volts
Peak Positive Pulse Plate Voltage .....	6500 Volts
Peak Negative Pulse Plate Voltage (Max.) .....	1500 Volts
Plate Dissipation (Max.) <sup>(2)</sup> .....	20 Watts
Peak Negative Grid No. 1 Voltage (Max.) .....	330 Volts
Grid No. 2 Voltage (Max.) .....	220 Volts
Grid No. 2 Dissipation (Max.) .....	3.5 Watts
Average Cathode Current (Max.) .....	275 Ma
Peak Cathode Current (Max.) .....	950 Ma
Grid No. 1 Circuit Resistance (Max.) .....	10.0 Megohms
Bulb Temperature (At Hottest Point) .....	240°C

**CHARACTERISTICS AND TYPICAL OPERATION**

Plate Voltage .....	6500	140 Volts
Grid No. 2 Voltage .....	140	140 Volts
Grid No. 1 Voltage .....	—	-24.5 Volts
Grid No. 3 Voltage .....	30	30 Volts
Plate Current .....	—	80 Ma
Grid No. 2 Current .....	—	2.4 Ma
Transconductance .....	—	9500 $\mu$ mhos
Plate Resistance .....	—	6000 Ohms
Amplification Factor <sup>(3)</sup> .....	—	4.0
$E_{c1}$ for $I_b = 1.0$ Ma (Approx.) .....	-110	-42 Volts

**INSTANTANEOUS PLATE KNEE VALUES (Sections in Parallel)**

$E_b = 60$  V;  $E_{c2} = 140$  V;  $E_{c3} = 30$  V; and  $E_{c1} = 0$  V  
 $I_b = 560$  Ma; and  $I_{c2} = 81$  Ma

**NOTES:**

- (1) For operation in a 525 line, 30 frame system as described in "Standards of Good Engineering Practice for Television Broadcast Stations; Federal Communications Commission," the duty cycle of the voltage pulse must not exceed 15% of one horizontal scanning cycle.
- (2) In stages operating with grid leak bias, an adequate cathode bias resistor or other suitable means is required to protect the tube in the absence of excitation.
- (3) Amplification factor with tube operating as a triode with 140 volts on the plate and Grid No. 2 and -24.5 volts on Grid No. 1. Grid No. 3 tied to cathode at socket.
- (4) Pins designated internal connection (IC) may or may not be internally connected to elements depending on the manufacturer. To maintain interchangeability these pins should not be used as tie points.

**AVERAGE PLATE CHARACTERISTICS**

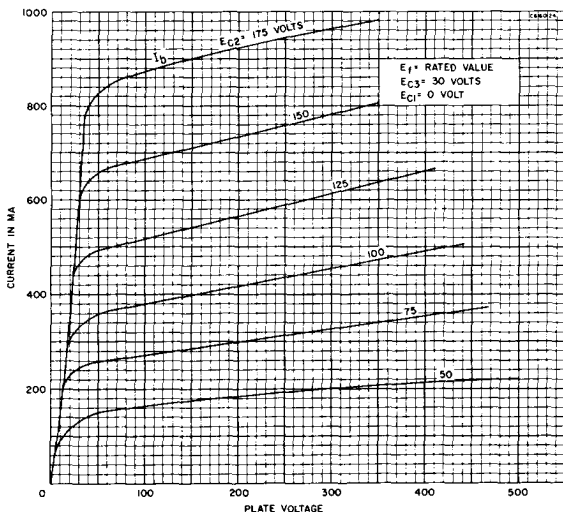

**6KM8**

**“Key” for VIBRATO CIRCUIT (D)  
FREQUENCY DIVIDER or  
COMPLEX WAVE GEN. (TT)**

**Diode and Sharp Cutoff  
Triple Plate Tetrode**

Construction ..... Miniature T-6½  
Base ..... Button 9 Pin, E9-1  
Basing ..... 9QG  
Outline ..... 6-3  
Maximum Diameter ..... 0.875 In.  
Maximum Seated Height ..... 2.375 In.  
Maximum Overall Height ..... 2.625 In.

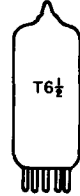
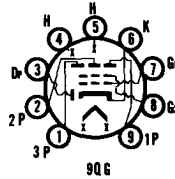

**ELECTRICAL DATA  
HEATER OPERATION**

Heater Voltage.....	6.3 Volts
Heater Current.....	300 Ma
Maximum Heater-Cathode Voltage	
Heater Negative with Respect to Cathode	
Total DC and Peak.....	200 Volts
Heater Positive with Respect to Cathode	
DC.....	100 Volts
Total DC and Peak.....	200 Volts

**DIRECT INTERELECTRODE CAPACITANCES (Unshielded)**

**Tetrode Unit:**

Grid No. 1 to Plate 1A (Max.).....	0.02 Pf
Grid No. 1 to Plate 1B (Max.).....	0.02 Pf
Grid No. 1 to Plate 2 (Max.).....	0.06 Pf
Grid No. 1 to Cathode and Internal Shield, Grid No. 2, and Heater.....	5.5 Pf
Plate 1A to Cathode and Internal Shield, Grid No. 2, and Heater.....	1.2 Pf
Plate 1B to Cathode and Internal Shield, Grid No. 2, and Heater.....	1.3 Pf
Plate 2 to Cathode and Internal Shield, Grid No. 2, and Heater.....	1.8 Pf
Tetrode Grid No. 1 to Diode Plate (Max.).....	0.024 Pf
Tetrode Plate 1A to Diode Plate.....	0.18 Pf
Tetrode Plate 1B to Diode Plate.....	0.024 Pf
Tetrode Plate 2 to Diode Plate.....	0.013 Pf

**RATINGS (Design Maximum Rating System)**

**Tetrode Unit**

**Frequency-Divider and Complex-Wave-Generator Service**

Plate Voltage:	
Plate 1A (Max.).....	330 Volts
Plate 1B (Max.).....	330 Volts
Plate 2 (Max.).....	330 Volts
Grid No. 2 (Screen Grid) Supply Voltage (Max.).....	330 Volts
Grid No. 2 Voltage.....	See Rating Chart (Gen. Info. Sec.)
Grid No. 1 (Control Grid) Voltage:	
Negative Bias Value (Max.).....	50 Volts
Positive Bias Value (Max.).....	0 Volt
Grid No. 2 Input:	
For Grid No. 2 Voltages up to 165 Volts (Max.).....	0.65 Watt
For Grid No. 2 Voltages Between 165 and 330 Volts.....	See Rating Chart (Gen. Info. Sec.)
Plate 1A Dissipation (Max.).....	1 Watt
Plate 1B Dissipation (Max.).....	1 Watt
Plate 2 Dissipation (Max.).....	1 Watt
Grid No. 1 Circuit Resistance:	
For Grid No. 1 Resistor Bias Operation (Max.).....	2.2 Megohms

**Diode Unit**

Plate Current (Max.).....	1 Ma
Plate Current for Plate Volts = 10 (Instantaneous Test Condition).....	2 Ma

**CHARACTERISTICS AND TYPICAL OPERATION**

**Class A1 Amplifier (Tetrode Unit)**

**(Plates 1A, 1B, and 2 connected together at socket)**

Plate Voltage.....	100 Volts
Grid No. 2 Voltage.....	100 Volts
Grid No. 1 Supply Voltage.....	0 Volts
Grid No. 1 Resistor (Bypassed).....	2.2 Megohms
Plate Resistance (Approx.).....	30,000 Ohms
Transconductance.....	3400 μmhos



Plate Current .....	4.2 Ma
Grid No. 2 Current .....	1.7 Ma
Grid No. 1 Voltage for Plate $\mu_a = 20$ (Approx.) .....	-4 Volts
<b>Triode Connection</b>	
<b>Grid No. 2 Connected to Plates 1A, 1B, and 2 at Socket</b>	
Plate Voltage .....	100 Volts
Grid No. 1 Supply Voltage .....	0 Volt
Grid No. 1 Resistor (Bypassed) .....	2.2 Megohms
Transconductance .....	4500 $\mu$ hos
Amplification Factor .....	45
Plate Current .....	5.5 Ma
<b>Separate Plate Operation (Plates Not Under Test Grounded)</b>	
Plate Voltage:	
Plate 1A .....	100 Volts
Plate 1B .....	100 Volts
Plate 2 .....	100 Volts
Grid No. 2 Voltage .....	100 Volts
Grid No. 1 Supply Voltage .....	0 Volt
Grid No. 1 Resistor (Bypassed) .....	2.2 Megohms
Transconductance:	
Grid No. 1 to Plate 1A .....	2000 $\mu$ hos
Grid No. 1 to Plate 1B .....	2000 $\mu$ hos
Grid No. 1 to Plate 2 .....	1800 $\mu$ hos
Plate Resistance (Approx.):	
Plate 1A .....	0.1 Megohm
Plate 1B .....	0.1 Megohm
Plate 2 .....	0.12 Megohm
Plate Current:	
Plate 1A .....	2.3 Ma
Plate 1B .....	2.3 Ma
Plate 2 .....	2.1 Ma
Grid No. 2 Current:	
For Plate 1A Volts = 100 .....	3.8 Ma
For Plate 1B Volts = 100 .....	3.8 Ma
For Plate 2 Volts = 100 .....	3.3 Ma

Color Television Type

**HORIZONTAL DEFLECTION  
AMPLIFIER**

**6KN6**

42KN6

**Beam Power Pentode  
(2 Sections in Parallel)**

Construction .....	Compactron T-12
Base .....	Button 12 Pin, E12-74
Top Cap .....	C1-2 or C1-3
Basing .....	12GU
Outline .....	12-82
Maximum Diameter .....	1.562 In.
Maximum Seated Height .....	4.000 In.
Maximum Overall Height .....	4.375 In.

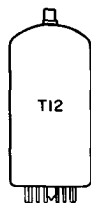
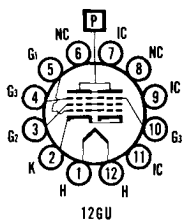

**ELECTRICAL DATA  
HEATER OPERATION**

Heater Voltage .....	<b>42KN6</b> 42	<b>6KN6</b> 6.3 Volts
Heater Current .....	450	3000 Ma
Heater Warm-up Time .....	11	— Seconds
Maximum Heater-Cathode Voltage		
Heater Negative with Respect to Cathode		
Total DC and Peak .....		200 Volts
Heater Positive with Respect to Cathode		
DC .....		100 Volts
Total DC and Peak .....		200 Volts

**DIRECT INTERELECTRODE CAPACITANCES (Unshielded)**

Grid to Plate .....	1.0 Pf
Input .....	44.0 Pf
Output .....	18.0 Pf

**RATINGS (Design Maximum Rating System)**

<b>Horizontal Deflection Amplifier (Sections in Parallel)<sup>(1)</sup></b>	
DC Plate Supply Voltage (Boost + DC Power Supply) (Max.) .....	770 Volts
Peak Positive Pulse Plate Voltage .....	6500 Volts
Peak Negative Pulse Plate Voltage (Max.) .....	1500 Volts

Plate Dissipation (Max.) <sup>(2)</sup> .....	30 Watts
Peak Negative Grid No. 1 Voltage (Max.) .....	330 Volts
Grid No. 2 Voltage (Max.) .....	220 Volts
Grid No. 2 Dissipation (Max.) .....	5.0 Watts
Average Cathode Current (Max.) .....	400 Ma
Peak Cathode Current (Max.) .....	1500 Ma
Grid No. 1 Circuit Resistance (Max.) .....	1.0 Megohm
Bulb Temperature (At Hottest Point) .....	260 °C

**CHARACTERISTICS AND TYPICAL OPERATION (Sections in Parallel)**

Plate Voltage .....	5500	130 Volts
Grid No. 2 Voltage .....	125	130 Volts
Grid No. 1 Voltage .....	—	-20 Volts
Plate Current .....	—	100 Ma
Grid No. 2 Current .....	—	4.0 Ma
Transconductance .....	—	16,000 $\mu$ mhos
Plate Resistance .....	—	4000 Ohms
Amplification Factor <sup>(3)</sup> .....	—	4.5
Ec1 for Ib = 1.0 Ma (Approx.) .....	—	-33 Volts
Ec1 for Ib = 75 $\mu$ a (Approx.) .....	100	— Volts

**INSTANTANEOUS PLATE KNEE VALUES (Sections in Parallel)**

Eb = 60 V, Ec2 = 125 V, and Ec1 = 0 V  
 Ib = 800 Ma; and Ic2 = 50 Ma

**NOTES:**

- (1) For operation in a 525 line, 30 frame system as described in "Standards of Good Engineering Practice for Television Broadcast Stations; Federal Communications Commission," the duty cycle of the voltage pulse must not exceed 15% of one horizontal scanning cycle.
- (2) In stages operating with grid leak bias, an adequate cathode bias resistor or other suitable means is necessary to protect the tube in the absence of excitation.
- (3) Amplification factor with tube operating as a triode with 130 volts on the plate and Grid No. 2 and -20 volts on Grid No. 1.

**AVERAGE PLATE CHARACTERISTICS**

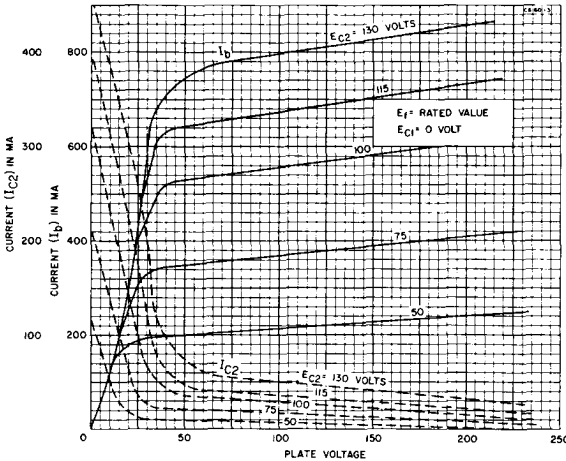

**6KR8**  
8KR8, 10KR8

**GENERAL PURPOSE AMPLIFIER (T)  
VIDEO AMPLIFIER (P)**

**Medium Mu Triode and Sharp Cutoff Pentode**

- Construction ..... Miniature T-6½
- Base ..... Button 9 Pin, E9-1
- Basing ..... 9DX
- Outline ..... 6-3
- Maximum Diameter ..... 0.875 In.
- Maximum Seated Height ..... 2.375 In.
- Maximum Overall Height ..... 2.625 In.

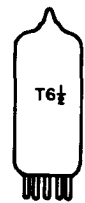
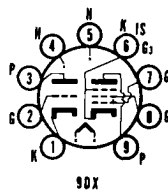

**ELECTRICAL DATA**

**HEATER OPERATION**

	8KR8	10KR8	6KR8
Heater Voltage.....	8.0	10.5	6.3 Volts
Heater Current .....	600	450	750 Ma
Heater Warm-up Time .....	11	11	— Seconds
Maximum Heater-Cathode Voltage			
Heater Negative with Respect to Cathode			
Total DC and Peak.....			200 Volts
Heater Positive with Respect to Cathode			
DC .....			100 Volts
Total DC and Peak.....			200 Volts

**DIRECT INTERELECTRODE CAPACITANCES (Unshielded)**

**Pentode Section**

Grid No. 1 to Plate (Pg1 to Pp) .....	0.075 Pf
Input: Pg1 to (h + Pk + Pg2 + Pg3 + IS) .....	13 Pf
Output: Pp to (h + Pk + Pg2 + Pg3 + IS) .....	4.4 Pf

**Triode Section**

Grid to Plate: (Tg to Tp) .....	2.6 Pf
Input: Tg to (h + Tk + Pk + Pg3 + IS) .....	4.2 Pf
Output: Tp to (h + Tk + Pk + Pg3 + IS) .....	3.0 Pf

**RATINGS (Design Maximum Rating System)**

	Pentode Section	Triode Section
Plate Voltage (Max.) .....	330	330 Volts
Screen Supply Voltage (Max.) .....	330	— Volts
Screen Voltage .....	See Rating Chart (Gen. Info. Sec.)	— Volts
Positive DC Grid No. 1 Voltage (Max.) .....	0	0 Volt
Plate Dissipation (Max.) .....	5.0	2.0 Watts
Screen Dissipation (Max.) .....	1.1	— Watts
Grid No. 1 Circuit Resistance		
With Fixed Bias (Max.) .....	0.01	0.5 Megohms
With Cathode Bias (Max.) .....	0.01	1.0 Megohms

**CHARACTERISTICS AND TYPICAL OPERATION**

	Pentode Section		Triode Section
Plate Voltage .....	35	200	125 Volts
Screen Voltage .....	100	100	— Volts
Grid No. 1 Voltage .....	0	—	— Volt
Cathode-Bias Resistor .....	—	82	68 Ohms
Amplification Factor .....	—	—	46
Plate Resistance (Approx.) .....	—	60,000	4400 Ohms
Transconductance .....	—	20,000	10,400 $\mu$ mhos
Plate Current .....	54	19.5	15 Ma
Screen Current .....	13.5	3.0	— Ma
Grid No. 1 Voltage (Approx.) $I_b = 10 \mu a$ .....	—	—	—8 Volts
Grid No. 1 Voltage (Approx.) $I_b = 100 \mu a$ .....	—	-6.3	— Volts

**GENERAL PURPOSE AMPLIFIER (T)  
VIDEO AMPLIFIER (P)**

**6KR8A**

**Medium Mu Triode and Sharp Cutoff Pentode**

Construction ..... Miniature T-6½  
 Base ..... Button 9 Pin, E9-1  
 Basing ..... 9DX  
 Outline ..... 6-3  
 Maximum Diameter ..... 0.875 In.  
 Maximum Seated Height ..... 2.375 In.  
 Maximum Overall Height ..... 2.625 In.  
 The Type 6KR8A is identical to the 6KR8 except for Screen Dissipating Rating of 1.5 Watts.

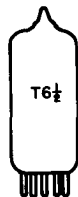
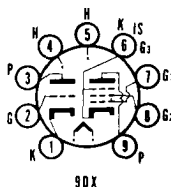

**6KS8**

8KS8

**SYNC SEPARATOR (T)  
VIDEO AMPLIFIER (P)**

**High Mu Triode and  
Semi-Remote Cutoff Pentode**

Construction ..... Miniature T-6½  
 Base ..... Button 9 Pin, E9-1  
 Basing ..... 9DX  
 Outline ..... 6-3  
 Maximum Diameter ..... 0.875 In.  
 Maximum Seated Height ..... 2.375 In.  
 Maximum Overall Height ..... 2.625 In.

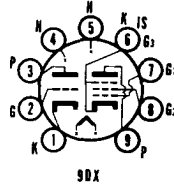

**ELECTRICAL DATA  
HEATER OPERATION**

	<b>8KS8</b>	<b>6KS8</b>
Heater Voltage.....	8.4	6.3 Volts
Heater Current .....	450	600 Ma
Heater Warm-up Time .....	11	— Seconds
Maximum Heater-Cathode Voltage		
Heater Negative with Respect to Cathode		
Total DC and Peak.....		200 Volts
Heater Positive with Respect to Cathode		
DC .....		100 Volts
Total DC and Peak.....		200 Volts

**DIRECT INTERELECTRODE CAPACITANCES**

	<b>Shielded<sup>(1)</sup></b>	<b>Unshielded</b>
<b>Triode Section</b>		
Grid to Plate .....	2.2	2.2 Pf
Input: g to (h + Tk + Pk, g3, IS) .....	3.4	3.2 Pf
Output: p to (h + Tk + Pk, g3, IS) .....	3.0	1.8 Pf
<b>Pentode Section</b>		
Grid No. 1 to Plate (Max.).....	0.04	0.05 Pf
Input: g1 to (h + Tk + Pk, g3, IS + g2) .....	10	10 Pf
Output: p to (h + Tk + Pk, g3, IS + g2) .....	4.5	3.6 Pf
<b>Coupling</b>		
Pentode Plate to Triode Plate (Max.) .....	0.025	0.150 Pf
Pentode Grid No. 1 to Triode Plate (Max.) .....	0.005	0.008 Pf

**RATINGS (Design Maximum Rating System)**

	<b>Triode Section</b>	<b>Pentode Section</b>
Plate Voltage (Max.) .....	330	330 Volts
Grid No. 2 Supply Voltage (Max.) .....	—	330 Volts
Grid No. 2 Voltage .....	See Rating Chart (Gen. Info. Sec.)	
Plate Dissipation (Max.) .....	1.1	3.75 Watts
Grid No. 2 Dissipation (Max.) .....	—	1.1 Watt
Positive Grid No. 1 Voltage (Max.) .....	0	0 Volt
Grid No. 1 Circuit Resistance		
Fixed Bias (Max.) .....	0.5	0.25 Megohm
Self Bias (Max.) .....	1.0	1.0 Megohm

Control grid to cathode spacing of the pentode section is of such low order of magnitude as to preclude the use of voltage between these elements of more than 100 volts DC and Peak AC in commercial tube checkers and shorts indicating devices, particularly where mechanical excitation of the tube is employed.

**CHARACTERISTICS AND TYPICAL OPERATION**

	<b>Triode Section</b>	<b>Pentode Section</b>
<b>Class A1 Amplifier</b>		
Plate Voltage .....	200	150 Volts
Grid No. 2 Voltage .....	—	150 Volts
Grid No. 1 Voltage .....	-2	0 Volts
Cathode Bias Resistor .....	—	150 Ohms
Plate Current .....	4.0	20 Ma
Grid No. 2 Current .....	—	4.5 Ma
Transconductance .....	4000	9500 μmhos
Amplification Factor .....	70	—
Plate Resistance (Approx.) .....	17,500	150,000 Ohms
E <sub>c1</sub> for I <sub>b</sub> = 100 μa (Approx.) .....	—	-10 Volts
E <sub>c1</sub> for I <sub>b</sub> = 20 μa (Approx.) .....	-5	— Volts

**PLATE KNEE CHARACTERISTICS**

$E_b = 65 \text{ V}$ ,  $E_{c2} = 150 \text{ V}$ ,  $E_{c1} = 0$  and  $I_b = 60 \text{ Ma}$ ,  $I_{c2} = 20 \text{ Ma}$

**NOTE:**

(1) External shield No. 315 connected to Pins 4 and 5.

*Color Television Type*

**SYNC SEP. or VOLTAGE AMP. (T)  
IF AMPLIFIER (P)**

**6KT8**

**High Mu Triode and High Gm Pentode**

Construction ..... Miniature T-6½  
 Base ..... Button 9 Pin, E9-1  
 Basing<sup>(2)</sup> ..... 9QP  
 Outline ..... 6-2  
 Maximum Diameter ..... 0.875 In.  
 Maximum Seated Height ..... 1.937 In.  
 Maximum Overall Height ..... 2.187 In.

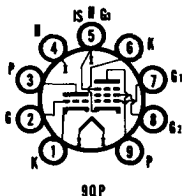

**ELECTRICAL DATA**

**HEATER OPERATION**

Heater Voltage.....	6.3 Volts
Heater Current.....	600 Ma
Maximum Heater-Cathode Voltage	
Heater Negative with Respect to Cathode	
Total DC and Peak.....	200 Volts
Heater Positive with Respect to Cathode	
DC.....	100 Volts
Total DC and Peak.....	200 Volts

**DIRECT INTERELECTRODE CAPACITANCES**

	Shielded <sup>(1)</sup>	Unshielded
<b>Triode Section</b>		
Grid to Plate.....	3.0	3.0 Pf
Input: g to (h + Pg3, IS + k).....	3.2	3.2 Pf
Output: p to (h + Pg3, IS + k).....	2.4	1.6 Pf
<b>Pentode Section</b>		
Grid No. 1 to Plate (Max.).....	0.03	0.03 Pf
Input: g1 to (h, g3, IS + g2 + k).....	7.5	7.5 Pf
Output: p to (h, g3, IS + g2 + k).....	2.8	2.2 Pf
<b>Coupling</b>		
Triode Grid to Pentode Plate (Max.).....	0.003	0.018 Pf
Pentode Grid No. 1 to Triode Plate (Max.).....	0.002	0.006 Pf

**RATINGS (Design Maximum Rating System)**

	Triode Section	Pentode Section
Plate Voltage (Max.).....	330	330 Volts
Grid No. 2 Supply Voltage (Max.).....	—	330 Volts
Grid No. 2 Voltage.....	See Rating Chart (Gen. Info. Sec.)	
Positive Grid No. 1 Voltage (Max.).....	0	0 Volt
Plate Dissipation (Max.).....	1.0	2.5 Watts
Grid No. 2 Dissipation (Max.).....	—	0.55 Watts
Grid No. 1 Circuit Resistance		
Fixed Bias (Max.).....	0.5	0.25 Megohm
Cathode Bias (Max.).....	1.0	1.0 Megohm

**CHARACTERISTICS AND TYPICAL OPERATION**

	Triode Section	Pentode Section
Plate Voltage.....	250	125 Volts
Grid No. 2 Voltage.....	—	125 Volts
Grid No. 1 Voltage.....	-2	-1 Volts
Plate Current.....	1.8	12 Ma
Grid No. 2 Current.....	—	4.5 Ma
Transconductance.....	3200	10,000 μmhos
Amplification Factor.....	100	—
Plate Resistance (Approx.).....	31,500	150,000 Ohms
$E_{c1}$ for $I_b = 20 \mu a$ (Approx.).....	-3.5	-7 Volts

**NOTES:**

- (1) External Shield No. 315 connected to Pins 4 and 5.
- (2) Due to the unique element connections, this tube is designed that Pin No. 5 be operated at or near ground potential. Pentode section Grid No. 3, Internal Shield and one side of the heater all connect to Pin No. 5. Should instantaneous total cathode to Grid No. 3 voltage exceed + 20 Volts, undesirable changes in tube characteristics may result.

**AVERAGE PLATE CHARACTERISTICS  
(Pentode Section)**

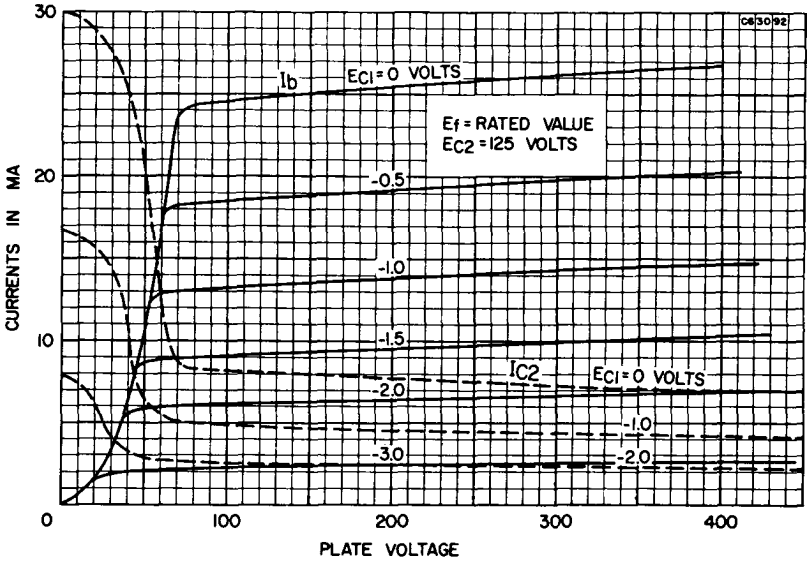

**AVERAGE PLATE CHARACTERISTICS  
(Triode Section)**

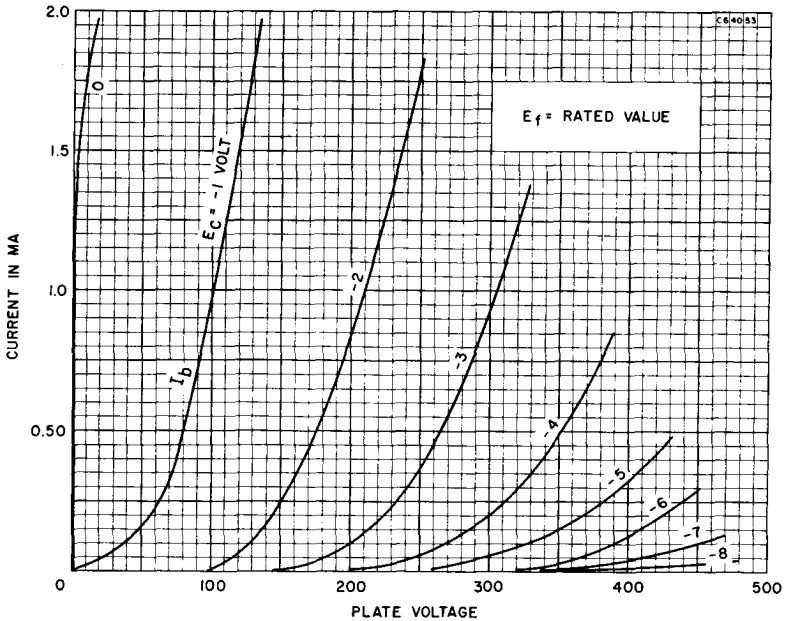

**HORIZONTAL PHASE DETECTOR (D)  
VIDEO AMPLIFIER (P)**

**6KU8  
10KU8**

**Double Diode and  
Sharp Cutoff Pentode**

Construction .....9T-9  
 Base .....Button 9 Pin, E9-68  
 Basing .....9LT  
 Outline .....9-69  
 Maximum Diameter .....1.188 In.  
 Maximum Seated Height .....2.320 In.  
 Maximum Overall Height .....2.630 In.

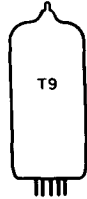
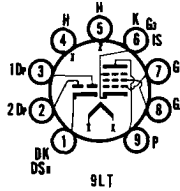

**ELECTRICAL DATA  
HEATER OPERATION**

Heater Voltage.....	<b>10KU8</b>	<b>6KU8</b>
Heater Current .....	10.2	6.3 Volts
Heater Warm-up Time .....	450	725 Ma
Maximum Heater-Cathode Voltage	11	— Seconds
Heater Negative with Respect to Cathode		
Total DC and Peak.....		200 Volts
Heater Positive with Respect to Cathode		
DC .....		100 Volts
Total DC and Peak.....		200 Volts

**DIRECT INTERELECTRODE CAPACITANCES (Unshielded)**

**Pentode**

Grid No. 1 to Plate: P <sub>g1</sub> to P <sub>p</sub> (Max.) .....	0.10 Pf
Input: P <sub>g1</sub> to (h + P <sub>k</sub> , g <sub>3</sub> + IS + g <sub>2</sub> + D <sub>k</sub> + IS) .....	12.0 Pf
Output: P <sub>p</sub> to (h + P <sub>k</sub> , g <sub>3</sub> + IS + g <sub>2</sub> + D <sub>k</sub> + IS) .....	3.0 Pf

**Diodes**

No. 1 Plate to All: No. 1 D <sub>p</sub> to (h + D <sub>k</sub> + IS + P <sub>k</sub> + g <sub>3</sub> + IS) .....	1.1 Pf
No. 2 Plate to All: No. 2 D <sub>p</sub> to (h + D <sub>k</sub> + IS + P <sub>k</sub> + g <sub>3</sub> + IS) .....	1.1 Pf
Cathode to No. 1 Plate: D <sub>k</sub> to (h + 1 D <sub>p</sub> + P <sub>k</sub> + g <sub>3</sub> + IS).....	0.8 Pf
Cathode to No. 2 Plate: D <sub>k</sub> to (h + 2 D <sub>p</sub> + P <sub>k</sub> + g <sub>3</sub> + IS).....	0.9 Pf

**Coupling**

Pentode Grid No. 1 to No. 1 Diode Plate (Max.) .....	0.003 Pf
Pentode Grid No. 1 to No. 2 Diode Plate (Max.) .....	0.003 Pf
Pentode Plate to No. 1 Diode Plate (Max.) .....	0.008 Pf
Pentode Plate to No. 2 Diode Plate (Max.) .....	0.008 Pf

**RATINGS (Design Maximum Rating System)**

Plate Voltage (Max.) .....	330 Volts
Grid No. 2 Supply Voltage (Max.) .....	330 Volts
Grid No. 2 Voltage .....	See Rating Chart (Gen. Info. Sec.)
Positive Grid No. 1 Voltage (Max.) .....	0 Volt
Plate Dissipation (Max.) .....	4.0 Watts
Grid No. 2 Dissipation (Max.) .....	1.1 Watts
Grid No. 1 Circuit Resistance	
Fixed Bias (Max.) .....	0.25 Megohm
Cathode Bias (Max.) .....	1.0 Megohm

Control grid to cathode spacing of the pentode section of this type is of such low order of magnitude as to preclude the use of voltage between these elements of more than 50 volts DC and Peak AC in commercial tube checkers and shorts indicating devices, particularly where mechanical excitation of the tube is employed.

**CHARACTERISTICS AND TYPICAL OPERATION**

Plate Voltage .....	200 Volts
Grid No. 2 Voltage .....	100 Volts
Grid No. 1 Voltage .....	0 Volt
Cathode Bias Resistor .....	82 Ohms
Plate Current .....	17 Ma
Grid No. 2 Current .....	3.5 Ma
Transconductance .....	20,000 μmhos
Plate Resistance (Approx.) .....	50,000 Ohms
E <sub>c1</sub> for I <sub>b</sub> = 100 μa (Approx.) .....	-5 Volts

**INSTANTANEOUS PLATE KNEE CHARACTERISTICS (Pentode Section)**

E<sub>b</sub> = 50 V, E<sub>c2</sub> = 100 V and E<sub>c1</sub> = 0 V  
 I<sub>b</sub> = 55 Ma, and I<sub>c2</sub> = 18 Ma

**DIODE CHARACTERISTICS (Each Diode)**

Average Current with 10 Vdc Applied .....	2.0 Ma
---	--------

**Pentode  
Section**

# 6KV6A

17KV6A, 22KV6A

## Color Television Type SHUNT REGULATOR

### Beam Power Pentode

Construction .....Novar T-12  
 Base .....Button 9 Pin, E9-88  
 (Exhaust Tip on Bottom)  
 Basing .....9QU  
 Outline .....12-96  
 Maximum Diameter .....1.562 In.  
 Maximum Seated Height .....3.000 In.  
 Maximum Overall Height .....3.380 In.

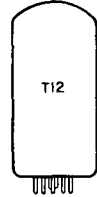
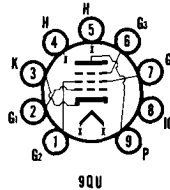

### ELECTRICAL DATA HEATER OPERATION

	22KV6A	17KV6A	6KV6A
Heater Voltage.....	22.0	16.8	6.3 Volts
Heater Current.....	450	600	1600 Ma
Heater Warm-up Time.....	11	11	— Seconds
Maximum Heater-Cathode Voltage			
Heater Negative with Respect to Cathode			
Total DC and Peak.....			500 Volts
Heater Positive with Respect to Cathode			
DC.....			100 Volts
Total DC and Peak.....			200 Volts

### DIRECT INTERELECTRODE CAPACITANCES (Unshielded)

Grid No. 1 to Plate.....	0.6 Pf
Input: G1 to (K, g3, g2, h).....	22 Pf
Output: p to (K, g3, g2, h).....	9.0 Pf

### RATINGS (Design Maximum Rating System)

DC Plate Supply Voltage (Ib = 0 Ma) (Max.).....	900 Volts
Peak Positive Pulse Plate Voltage (Max.) <sup>(3)</sup> .....	6500 Volts
Peak Negative Pulse Plate Voltage (Max.).....	1500 Volts
DC Grid No. 3 Voltage (Max.).....	75 Volts
DC Grid No. 2 Screen Grid Voltage (Max.).....	220 Volts
Grid No. 1 Control Grid Voltage	
Peak Negative Pulse Value (Max.).....	330 Volts
Negative DC Bias Value (Max.).....	250 Volts
Cathode Current	
Peak (Max.).....	950 Ma
Average (Max.) <sup>(4)</sup> .....	275 Ma
Grid No. 2 Input (Max.).....	2.0 Watts
Plate Dissipation (Max.) <sup>(5)</sup> .....	28 Watts
Envelope Temperature (At Hottest Point).....	240 °C
Grid No. 1 Circuit Resistance	
For Grid No. 1 Resistor Bias Operation.....	1 Megohm

### CHARACTERISTICS AND TYPICAL OPERATION

DC Plate Voltage.....	100	140 Volts
DC Grid No. 3 Voltage.....	0	0 Volt
DC Grid No. 2 Voltage.....	140	140 Volts
DC Grid No. 1 Voltage.....	0	-24.5 Volts
Amplification Factor (Triode Connection) <sup>(1)</sup> .....	—	4
Plate Resistance (Approx.).....	—	6000 Ohms
Transconductance.....	—	10,000 μmhos
DC Plate Current.....	440 <sup>(2)</sup>	40 Ma
DC Grid No. 2 Current.....	30 <sup>(2)</sup>	2.4 Ma
Cutoff DC Grid No. 1 Voltage for Ib = 1 Ma.....	—	-42 Volts

### NOTES:

- (1) With Grid No. 3 and Grid No. 2 connected, respectively, to cathode and plate at socket.
- (2) This value can be measured by a method involving a recurrent waveform such that the Maximum Ratings of the tube will not be exceeded.
- (3) This rating is applicable where the duration of the voltage pulse does not exceed 15% of one horizontal scanning cycle. In a 525-line, 30-frame system, 15% of one horizontal scanning cycle is 10 μs.
- (4) Measured with a DC meter.
- (5) Adequate circuit precautions must be taken to protect the tube in the absence of Grid No. 1 bias.
- (6) Plate dissipations up to 24 W maximum are permissible for short periods of time (up to 10 seconds maximum) provided the maximum envelope temperature rating is not exceeded.



**SYNC SEPARATOR, SOUND  
IF/VOLTAGE AMP. (T)  
VIDEO AMPLIFIER (P)**

**6KV8**

11KV8

**High Mu Triode and  
Sharp Cutoff Pentode**

Construction ..... Miniature T-6½  
Base ..... Button 9 Pin, E9-1  
Basing ..... 9DX  
Outline ..... 6-3  
Maximum Diameter ..... 0.875 In.  
Maximum Seated Height ..... 2.375 In.  
Maximum Overall Height ..... 2.625 In.

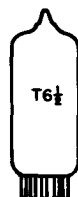
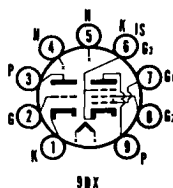

**ELECTRICAL DATA**

**HEATER OPERATION**

	11KV8	6KV8
Heater Voltage.....	10.9	6.3 Volts
Heater Current .....	450	775 Ma
Heater Warm-up Time .....	11	— Seconds
Maximum Heater-Cathode Voltage		
Heater Negative with Respect to Cathode		
Total DC and Peak.....		200 Volts
Heater Positive with Respect to Cathode		
DC .....		100 Volts
Total DC and Peak.....		200 Volts

**DIRECT INTERELECTRODE CAPACITANCES (Unshielded)**

**Triode Section**

Grid to Plate .....	3.7 Pf
Input: g to (h + Tk + Pk, g3, IS) .....	2.5 Pf
Output: p to (h + Tk + Pk, g3, IS) .....	2.4 Pf

**Pentode Section**

Grid No. 1 to Plate (Max.).....	0.12 Pf
Input: g1 to (h + Pk, g3, IS + g2) .....	13 Pf
Output: p to (h + Pk, g3, IS + g2) .....	4.8 Pf

**Coupling**

Triode Grid to Pentode Plate (Max.) .....	0.015 Pf
Pentode Plate to Triode Plate (Max.) .....	0.17 Pf

**RATINGS (Design Maximum Rating System)**

	Triode Section	Pentode Section
Plate Voltage (Max.) .....	300	300 Volts
Grid No. 2 Supply Voltage (Max.) .....	—	300 Volts
Grid No. 2 Voltage .....	See Rating Chart (Gen. Info. Sec.)	
Positive Grid No. 1 Voltage (Max.) .....	0	0 Volt
Plate Dissipation (Max.) .....	1.0	5.0 Watts
Grid No. 2 Dissipation		
Up to 150 Voltage (Max.) .....	—	1.1 Watts
150 to 300 Volts .....	See Rating Chart (Gen. Info. Sec.)	
Grid No. 1 Circuit Resistance		
Fixed Bias (Max.) .....	0.5	0.1 Megohm
Cathode Bias (Max.) .....	1.0	0.25 Megohm

Control grid to cathode spacing of the pentode section of this type is of such low order of magnitude as to preclude the use of voltage between these elements of more than 50 volts DC or peak AC in commercial tube checkers and shorts indicating devices, particularly where mechanical excitation of the tube is employed.

**CHARACTERISTICS AND TYPICAL OPERATION**

	Triode Section	Pentode Section	
Plate Voltage .....	200	125	200 Volts
Grid No. 2 Voltage .....	—	125	125 Volts
Grid No. 1 Voltage .....	-2	0	0 Volts
Cathode Bias Resistor .....	—	82	68 Ohms
Plate Current .....	4	16.5	20 Ma
Grid No. 2 Current .....	—	3.1	3.5 Ma
Transconductance .....	4000	21,000	23,000 μmhos
Amplification Factor .....	70	—	—
Plate Resistance (Approx.) .....	17,500	55,000	75,000 Ohms
E <sub>c1</sub> for I <sub>b</sub> = 100 μa (Approx.) .....	-4.5	-4.2	-4.2 Volts

**6KY8**  
15KY8

**VERTICAL DEFLECTION  
OSCILLATOR (T) and  
AMPLIFIER (P)**

**High Mu Triode and  
Beam Power Pentode**

Construction .....Novar T-9  
Base .....Button 9 Pin, E9-75  
Basing .....9QT  
Outline  
Maximum Diameter .....1.188 In.  
Maximum Seated Height .....2.730 In.  
Maximum Overall Height .....3.110 In.

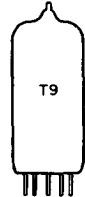
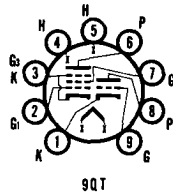

**ELECTRICAL DATA**

**HEATER OPERATION**

	15KY8	6KY8
Heater Voltage.....	15.0	6.3 Volts
Heater Current .....	450	1100 Ma
Heater Warm-up Time .....	11	— Seconds
Maximum Heater-Cathode Voltage		
Heater Negative with Respect to Cathode		
Total DC and Peak.....		200 Volts
Heater Positive with Respect to Cathode		
DC .....		100 Volts
Total DC and Peak.....		200 Volts

**DIRECT INTERELECTRODE CAPACITANCES (Unshielded)**

**Triode Section**

Grid to Plate .....	0.44 Pf
Input: g to (h + Tk) .....	15.0 Pf
Output: p to (h + Tk) .....	7.0 Pf

**Pentode Section**

Grid No. 1 to Plate (Max.).....	0.048 Pf
Input: g1 to (h + Pk, g2, g3).....	2.6 Pf
Output: p to (h + Pk, g2, g3).....	0.28 Pf

**RATINGS (Design Maximum Rating System)**

**Vertical Deflection Oscillator and Amplifier<sup>(1)</sup>**

	Tri. Osc.	Pent. Amp.
Plate Voltage (Max.) .....	330	300 Volts
Grid No. 2 Voltage (Max.) .....	—	150 Volts
Peak Positive Pulse Plate Voltage (Max.) .....	—	2000 Volts
Peak Negative Grid No. 1 Voltage (Max.) .....	400	250 Volts
Plate Dissipation (Max.) <sup>(2)</sup> .....	1.5	12 Watts
Grid No. 2 Dissipation (Max.) <sup>(2)</sup> .....	—	1.9 Watts
Average Cathode Current (Max.).....	22	70 Ma
Peak Cathode Current (Max.) .....	77	200 Ma
Grid Circuit Resistance		
Self Bias (Max.) .....	2.2	2.2 Megohm

**CHARACTERISTICS AND TYPICAL OPERATION**

	Triode Section	Pentode Section
Plate Voltage .....	250	135 Volts
Grid No. 2 Voltage .....	—	120 Volts
Grid No. 1 Voltage .....	-3	-10 Volts
Plate Current .....	1.4	39 Ma
Grid No. 2 Current .....	—	3 Ma
Transconductance .....	1600	8400 $\mu$ mhos
Amplification Factor .....	64	—
Plate Resistance (Approx.) .....	40,000	18,000 Ohms
Ec for Ib = 1 Ma (Approx.).....	—	-24 Volts

**INSTANTANEOUS PLATE KNEE VALUES**

Eb = 50 V; Ec2 = 120 V; and Ec = 0 V  
Ib = 170 Ma, and Ic2 = 20 Ma

**NOTES:**

- (1) For operation in a 525 line, 30 frame system as described in "Standards of Good Engineering Practice for Television Broadcast Stations; Federal Communications Commission," the duty cycle of the voltage pulse must not exceed 15% of one horizontal scanning cycle.
- (2) In stages operating with grid leak bias, an adequate cathode bias resistor or other suitable means is required to protect the tube in the absence of excitation.

**VERTICAL DEFLECTION  
OSCILLATOR (T) and  
AMPLIFIER (P)**

**6KY8A**

15KY8A

**High Mu Triode and  
Beam Power Pentode**

Construction .....Novar T-9  
Base .....Button 9 Pin, E9-89  
(Exhaust Tip on Base)  
Basing .....9QT  
Outline .....9-107  
Maximum Diameter .....1.188 In.  
Maximum Seated Height .....2.000 In.  
Maximum Overall Height .....2.380 In.  
The 6KY8A and 15KY8A are identical to the 6KY8 and 15KY8 except for Base with exhaust tip on bottom and shorter bulb.

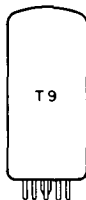
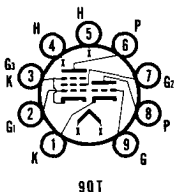

*Color Television Type*  
**VHF OSCILLATOR and MIXER**

**6KZ8**

5KZ8, 9KZ8

**Medium Mu Triode and  
Sharp Cutoff Pentode**

Construction .....Miniature T-6½  
Base .....Button 9 Pin, E9-1  
Basing .....9FZ  
Outline .....6-2  
Maximum Diameter .....0.875 In.  
Maximum Seated Height .....1.937 In.  
Maximum Overall Height .....2.187 In.

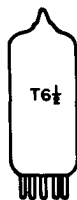
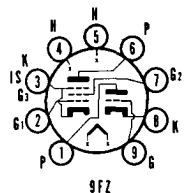

**ELECTRICAL DATA  
HEATER OPERATION**

Heater Voltage.....  
Heater Current.....  
Heater Warm-up Time.....  
Maximum Heater-Cathode Voltage  
Heater Negative with Respect to Cathode  
Total DC and Peak.....  
Heater Positive with Respect to Cathode  
DC.....  
Total DC and Peak.....

<b>9KZ8</b>	<b>5KZ8</b>
9.45	4.7
300	600
11	11

<b>6KZ8</b>
6.3 Volts
450 Ma
11 Seconds

**DIRECT INTERELECTRODE CAPACITANCES (Shielded)<sup>(1)</sup>**

**Triode Section**

Grid to Plate ..... 1.6 Pf  
Input: g to (Tk + Pk + g3 + h + IS) ..... 3.2 Pf  
Output: p to (Tk + Pk + g3 + h + IS) ..... 1.8 Pf  
Heater to Cathode ..... 3.2<sup>(2)</sup> Pf

**Pentode Section**

Grid No. 1 to Plate (Max.)..... 0.01 Pf  
Input: g1 to (k + g3 + g2 + h + IS)..... 5.5 Pf  
Output: p to (k + g3 + g2 + h + IS)..... 3.4 Pf  
Heater to Cathode ..... 3.2<sup>(2)</sup> Pf

**RATINGS (Design Maximum Rating System)**

**Converter Service**

	<b>Triode Section</b>	<b>Pentode Section</b>
Plate Voltage (Max.)	330	330 Volts
Grid No. 2 Supply Voltage (Max.)	—	330 Volts
Grid No. 2 Voltage	See Rating Chart	(Gen. Info. Sec.)
Plate Dissipation (Max.)	2.5	2.5 Watts
Screen Dissipation (Max.)	—	0.55 Watt
Positive Grid No. 1 Voltage (Max.)	0	0 Volt
Grid No. 1 Circuit Resistance		
Fixed Bias (Max.)	0.25	0.25 Megohm
Self Bias (Max.)	0.5	0.5 Megohm

**CHARACTERISTICS AND TYPICAL OPERATION**

	<b>Triode Section</b>	<b>Pentode Section</b>
Plate Voltage .....	125	125 Volts
Grid No. 2 Voltage .....	—	125 Volts
Grid No. 1 Voltage .....	-1	-1 Volt
Plate Current .....	13.5	12 Ma
Grid No. 2 Current .....	—	4.0 Ma
Transconductance .....	8500	7500 $\mu$ mhos
Amplification Factor .....	46	—
Plate Resistance (Approx.) .....	5400	200,000 Ohms
$E_{c1}$ for $I_b = 10 \mu$ a (Approx.) .....	-8	-8 Volts

**NOTES:**

- (1) Shield No. 315 connected to cathode.
- (2) Shield No. 315 connected to ground.

**AVERAGE PLATE CHARACTERISTICS  
(Pentode Section)**

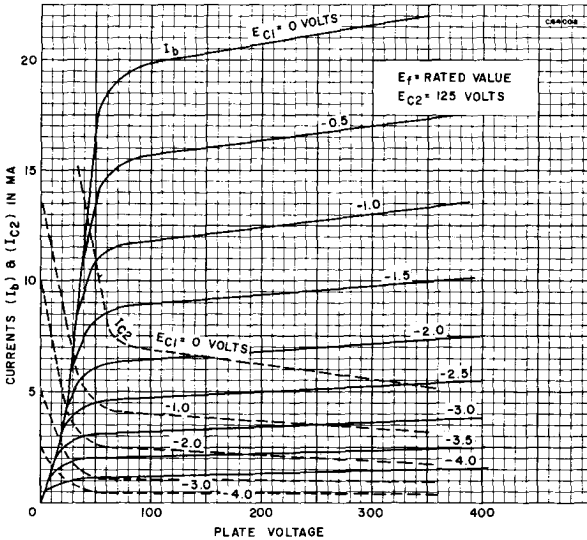

**AVERAGE PLATE CHARACTERISTICS  
(Triode Section)**

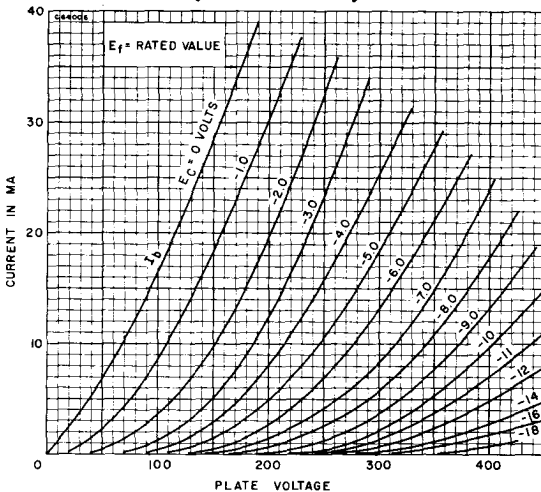

# AUDIO POWER AMPLIFIER

# 6L6GC

## Beam Power Pentode

Construction .....Octal T-12  
 Base .....6 or 7 Pin, B6-122, B6-148  
                                   B7-12, B7-111 or B7-119  
 Basing .....7S  
 Outline .....12-15  
 Maximum Diameter .....1.562 In.  
 Maximum Seated Height .....3.688 In.  
 Maximum Overall Height .....4.250 In.

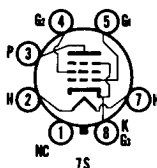

## ELECTRICAL DATA

### HEATER OPERATION

Heater Voltage.....	6.3 Volts
Heater Current.....	900 Ma
Maximum Heater-Cathode Voltage	
Heater Negative with Respect to Cathode	
Total DC and Peak.....	200 Volts
Heater Positive with Respect to Cathode	
DC.....	100 Volts
Total DC and Peak.....	200 Volts

### DIRECT INTERELECTRODE CAPACITANCES (Unshielded)

Grid No. 1 to Plate.....	0.6 Pf
Input.....	10 Pf
Output.....	6.5 Pf

### RATINGS (Design Maximum Rating System)

#### Class AB1 Pentode Operation

	Triode Conn.	Pentode Conn.
Plate Voltage (Max.).....	450	500 Volts
Grid No. 2 Voltage (Max.).....	—	450 <sup>(1)</sup> Volts
Plate Dissipation (Max.).....	30	30 Watts
Grid No. 2 Dissipation (Max.).....	—	5.0 Watts
Grid No. 1 Circuit Resistance		
Fixed Bias (Max.).....	0.1	0.1 Megohm
Cathode Bias (Max.).....	0.5	0.5 Megohm

### CHARACTERISTICS AND TYPICAL OPERATION

#### Pentode Operation (Class A1 Amp.)

	Single Tube			Push-Pull	
Plate Voltage.....	250	300	250	250	270 Volts
Grid No. 2 Voltage.....	250	200	250	250	270 Volts
Grid No. 1 Voltage.....	-14	-12.5	-18	-16	-17.5 Volts
Peak AF Grid Voltage.....	14	12.5	18	16	17.5 Volts
Zero Signal Plate Current.....	72	48	54	120	134 Ma
Maximum Signal Plate Current.....	79	55	66	140	155 Ma
Zero Signal Grid No. 2 Current.....	5.0	2.5	2.5	10	11 Ma
Maximum Signal Grid No. 2 Current.....	7.3	4.7	7.0	16	17 Ma
Transconductance.....	6K	5.3K	5.2K	—	— μmhos
Plate Resistance (Approx.).....	22.5K	35K	33K	—	— Ohms
Load Resistance.....	2.5K	4.5K	4.2K	—	— Ohms
Load Resistance (PL to PL).....	—	—	—	5K	5K Ohms
Power Output.....	6.5	6.5	10.8	14.5	17.5 Watts
Total Harmonic Distortion.....	10	11	15	2	2 Percent

#### Pentode Operation

	Class AB2 Push-Pull		Class AB1 Push-Pull	
Plate Voltage.....	360	360	360	450 Volts
Grid No. 2 Voltage.....	225	270	270	400 Volts
Grid No. 1 Voltage.....	-18	-22.5	-22.5	-37 Volts
Peak AF Grid Voltage.....	26	36	22.5	35 Volts
Zero Signal Plate Current.....	78	88	88	116 Ma
Maximum Signal Plate Current.....	142	205	132	210 Ma
Zero Signal Grid No. 2 Current.....	3.5	5.0	5.0	5.6 Ma
Maximum Signal Grid No. 2 Current.....	11	16	15	22 Ma
Load Resistance (PL to PL).....	6000	3800	6600	5600 Ohms
Power Output.....	31	47	26.5	55 Watts
Total Harmonic Distortion.....	2	2	2	1.8 Percent

**Triode Operation**

	<b>Class A1 Amp. Single Tube</b>	<b>Class AB1 Amp. Push-Pull</b>
Plate Voltage .....	250	400 Volts
Grid No. 1 Voltage .....	-20	-40 Volts
Peak AF Grid No. 1 Voltage .....	20	40 Volts
Zero Signal Plate Current .....	40	95 Ma
Maximum Signal Plate Current .....	44	140 Ma
Transconductance .....	4700	— $\mu$ mhos
Amplification Factor .....	8	—
Plate Resistance .....	1700	— Ohms
Load Resistance .....	5000	— Ohms
Load Resistance (PL to PL) .....	—	4500 Ohms
Power Output .....	1.4	12.5 Watts
Total Harmonic Distortion .....	5	3.5 Percent

**NOTE:**

(1) The maximum Grid No. 2 voltage rating is 500 volts in push-pull circuits where Grid No. 2 of each tube is connected to a tap on the plate winding of the output transformer.

**AVERAGE PLATE CHARACTERISTICS**

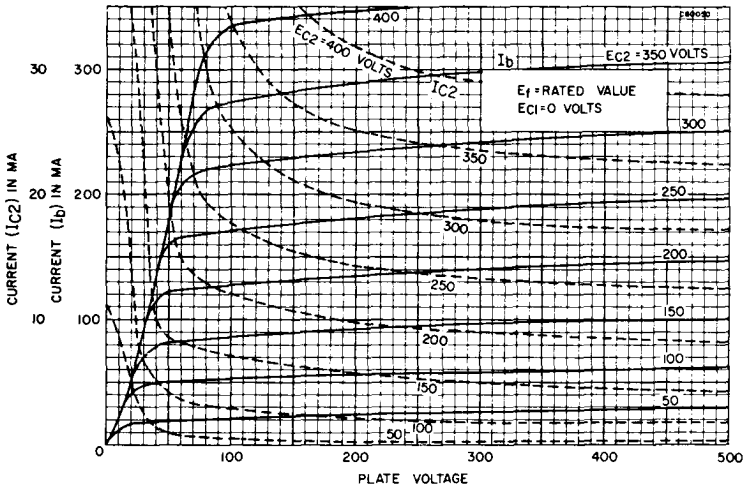

**AVERAGE TRANSFER CHARACTERISTICS**

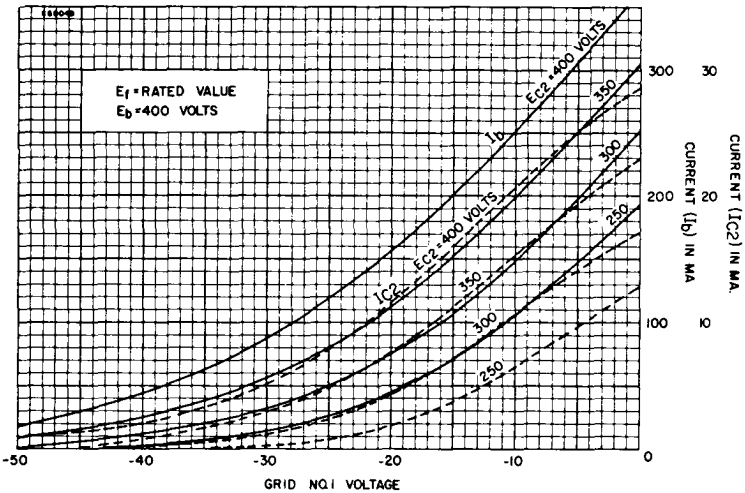

**AVERAGE PLATE CHARACTERISTICS**

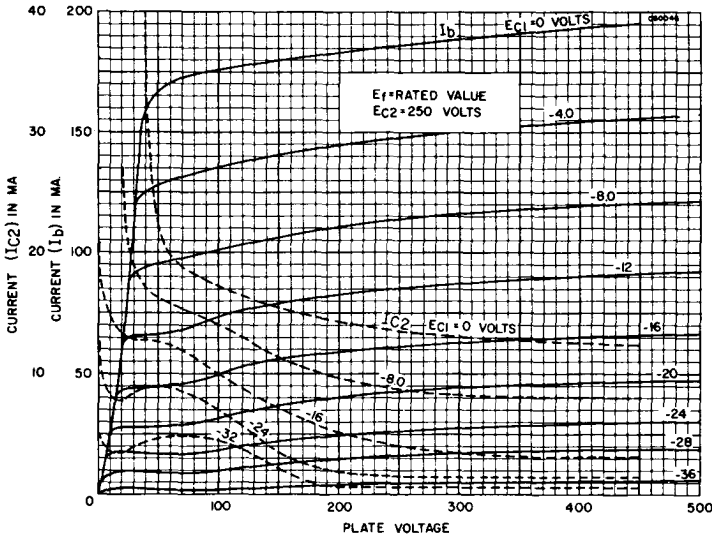

*Color Television Type*  
**HORIZONTAL DEFLECTION  
 AMPLIFIER**

**6LB6**

**Beam Power Pentode**

- Construction ..... Compactron T-12
- Base ..... Button 12 Pin, E12-74
- Top Cap ..... C1-1
- Basing ..... 12FY
- Outline ..... 12-90
- Maximum Diameter ..... 1.563 In.
- Maximum Seated Height ..... 4.000 In.
- Maximum Overall Height ..... 4.375 In.

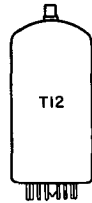
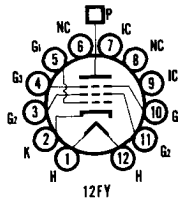

**ELECTRICAL DATA**

**HEATER OPERATION**

Heater Voltage.....	6.3 Volts
Heater Current .....	2250 Ma
Maximum Heater-Cathode Voltage	
Heater Negative with Respect to Cathode	
Total DC and Peak.....	200 Volts
Heater Positive with Respect to Cathode	
DC .....	100 Volts
Total DC and Peak.....	200 Volts

**DIRECT INTERELECTRODE CAPACITANCES (Unshielded)**

Grid No. 1 to Plate .....	0.44 Pf
Input: g1 to (h + k + g2 + bp).....	33 Pf
Output: p to (h + k + g2 + bp).....	18 Pf

**RATINGS (Design Maximum Rating System)**

**Horizontal Deflection Amplifier Service<sup>(1)</sup>**

DC Plate-Supply Voltage (Boost + DC Power Supply) (Max.) .....	990 Volts
Peak Positive Pulse Plate Voltage (Absolute Maximum Value) .....	7000 Volts
Peak Negative Pulse Plate Voltage (Max.) .....	100 Volts
Positive DC Beam Plate Voltage (Max.) .....	0 Volt
Screen Voltage (Max.) .....	200 Volts
Peak Negative Grid No. 1 Voltage (Max.) .....	300 Volts
Plate Dissipation (Absolute Maximum Value) <sup>(2)</sup> .....	30 Watts
Screen Dissipation (Max.) .....	5.0 Watts

DC Cathode Current (Max.) .....	315 Ma
Peak Cathode Current (Max.) .....	1100 Ma
Grid No. 1 Circuit Resistance	
With Feedback-Type High Voltage Regulation (Max.) .....	1.2 Megohms
With Shunt-Type High Voltage Regulation (Switching Mode) (Max.) ..	10.0 Megohms
Beam Plate Circuit Resistance (Max.) .....	0 Ohms
Bulb Temperature (Max.) <sup>(4)</sup> .....	200 °C

**CHARACTERISTICS AND TYPICAL OPERATION**

Plate Voltage .....	5000	45	50	150 Volts
Beam Plates .....	Connected to Cathode at Socket			
Screen Voltage .....	110	160	110	110 Volts
Grid No. 1 Voltage .....	—	0	—	-20 Volts
Plate Resistance (Approx.) .....	—	—	—	6600 Ohms
Transconductance .....	—	—	—	13,400 $\mu$ mhos
Plate Current .....	—	900 <sup>(4)</sup>	560 <sup>(4)</sup>	105 Ma
Screen Current .....	—	110 <sup>(4)</sup>	46 <sup>(4)</sup>	2.0 Ma
Grid No. 1 Voltage (Approx.)				
I <sub>b</sub> = 1.0 Ma .....	-125	—	—	-40 Volts
Triode Amplification Factor <sup>(5)</sup> .....	—	—	—	4.0

**NOTES:**

- (1) For operation in a 525 line, 30 frame system as described in "Standards of Good Engineering Practice for Television Broadcast Stations; Federal Communications Commission," the duty cycle of the voltage pulse must not exceed 15% of one horizontal scanning cycle.
- (2) In stages operating with grid-leak bias, an adequate cathode-bias resistor or other suitable means is required to protect the tube in the absence of excitation.
- (3) Measured using a thermocouple attached to a 0.1-inch wide phosphor-bronze ring placed at the hottest location on the bulb.
- (4) Values measured by a method involving a recurrent waveform such that the plate and screen dissipation will be kept within ratings in order to prevent damage to the tube.
- (5) Triode connection (screen tied to plate) with E<sub>b</sub> = E<sub>c2</sub> = 125 volts, and E<sub>c1</sub> = -25 volts.



**Medium Mu Triode and Sharp Cutoff Pentode**

Construction .....	9T-9
Base .....	Button 9 Pin, E9-68
Basing .....	9DX
Outline .....	9-69
Maximum Diameter .....	1.188 In.
Maximum Seated Height .....	2.320 In.
Maximum Overall Height .....	2.630 In.

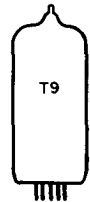
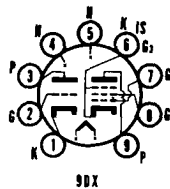

**ELECTRICAL DATA**  
**HEATER OPERATION**

Heater Voltage .....	<b>10LB8</b>	<b>6LB8</b>
Heater Current .....	10.2	6.3 Volts
Heater Warm-up Time .....	450	725 Ma
Maximum Heater-Cathode Voltage	11	— Seconds
Heater Negative with Respect to Cathode		
Total DC and Peak .....		200 Volts
Heater Positive with Respect to Cathode		
DC .....		100 Volts
Total DC and Peak .....		200 Volts

**DIRECT INTERELECTRODE CAPACITANCES (Unshielded)**

**Triode Section**

Grid to Plate .....	2.8 Pf
Input: g to (h + Tk + Pk, g <sub>3</sub> , IS) .....	1.9 Pf
Output: p to (h + Tk + Pk, g <sub>3</sub> , IS) .....	1.8 Pf

**Pentode Section**

Grid No. 1 to Plate (Max.) .....	0.10 Pf
Input: g <sub>1</sub> to (h + Pk, g <sub>3</sub> , IS + g <sub>2</sub> ) .....	12 Pf
Output: p to (h + Pk, g <sub>3</sub> , IS + g <sub>2</sub> ) .....	3.0 Pf

**Coupling**

Triode Grid to Pentode Plate (Max.) .....	0.02 Pf
Pentode Grid No. 1 to Triode Plate (Max.) .....	0.004 Pf
Pentode Plate to Triode Plate (Max.) .....	0.13 Pf



**RATINGS (Design Maximum Rating System)**

	Triode Section	Pentode Section
Plate Voltage (Max.) .....	330	330 Volts
Grid No. 2 Supply Voltage (Max.) .....	—	330 Volts
Grid No. 2 Voltage .....	See Rating Chart (Gen. Info. Sec.)	
Positive Grid No. 1 Voltage (Max.) .....	0	0 Volt
Plate Dissipation (Max.) <sup>(2)</sup> .....	2.0	4.0 Watts
Grid No. 2 Dissipation (Max.) .....	—	1.1 Watts
Grid No. 1 Circuit Resistance		
Fixed Bias (Max.) .....	0.5	0.25 Megohm
Cathode Bias (Max.) .....	1.0	1.0 Megohm

Control grid to cathode spacing of the pentode section of this type is of such low order of magnitude as to preclude the use of voltage between these elements of more than 50 volts dc or peak ac in commercial tube checkers and shorts indicating devices, particularly where mechanical excitation of the tube is employed.

**CHARACTERISTICS AND TYPICAL OPERATION**

	Triode Section	Pentode Section
Plate Voltage .....	125	200 Volts
Grid No. 2 Voltage .....	—	100 Volts
Grid No. 1 Voltage .....	0	0 Volt
Cathode Bias Resistor .....	68	82 Ohms
Plate Current .....	13	17 Ma
Grid No. 2 Current .....	—	3.5 Ma
Transconductance .....	5000	20,000 $\mu$ mhos
Amplification Factor .....	30	—
Plate Resistance (Approx.) .....	6000	50,000 Ohms
E <sub>c1</sub> for I <sub>b</sub> = 100 $\mu$ a (Approx.) .....	—	-5 Volts
E <sub>c</sub> for I <sub>b</sub> = 20 $\mu$ a (Approx.) .....	-10	— Volts

**INSTANTANEOUS PLATE KNEE CHARACTERISTICS (Pentode Section)<sup>(1)</sup>**

E<sub>b</sub> = 50 V, E<sub>c2</sub> = 100 V and E<sub>c1</sub> = 0 V  
I<sub>b</sub> = 55 Ma and I<sub>c2</sub> = 18 Ma

**NOTES:**

- (1) Applied for short interval (2 Sec. Max.) so as not to damage tube.
- (2) Maximum total plate dissipation, both plates, should not exceed 5.0 watts.

Color Television Type

**SHUNT REGULATOR**

6LC6

**Beam Power Triode**

Construction .....	Octal T-12
Base .....	Octal 8 Pin, B8-70 or B8-118
Top Cap .....	C1-1 or C1-34
Basing <sup>(1)</sup> .....	8ML
Outline .....	12-36
Maximum Diameter .....	1.562 In.
Maximum Seated Height .....	4.438 In.
Maximum Overall Height .....	5.000 In.

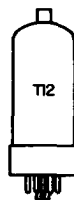
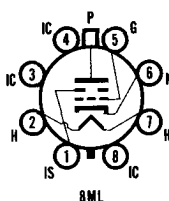

**ELECTRICAL DATA**

**HEATER OPERATION**

Heater Voltage .....	6.3 Volts
Heater Current .....	200 Ma
Maximum Heater-Cathode Voltage	
Heater Negative with Respect to Cathode <sup>(2)</sup> .....	450 Volts
Heater Positive with Respect to Cathode .....	Not Recommended

**DIRECT INTERELECTRODE CAPACITANCES (Unshielded)**

Grid to Plate: (g to P) .....	1.0 Pf
Input: g to (h + k) .....	2.6 Pf
Output: p to (h + k) .....	1.0 Pf

**RATINGS (Design Maximum Rating System)**

Plate Supply Voltage, Unregulated (Max.) .....	60,000 Volts
Plate Voltage (Max.) .....	27,000 Volts
Negative DC Grid Voltage (Max.) .....	135 Volts
Peak Negative Grid Voltage (Max.) <sup>(2)</sup> .....	440 Volts
Plate Dissipation (Max.) .....	40 Watts
DC Plate Current (Max.) .....	1.6 Ma
Grid Circuit Resistance (Max.) .....	3.0 Megohms

**CHARACTERISTICS AND TYPICAL OPERATION**

Unregulated DC Supply Voltage .....	36,000 Volts
Equivalent Resistance of Unregulated Supply .....	11 Megohms
DC Reference Voltage .....	200 Volts
Equivalent Resistance of Reference Supply .....	1000 Ohms
Effective Grid-Plate Transconductance .....	200 $\mu$ mhos
DC Plate Current for Zero Load Current .....	1000 $\mu$ a
DC Plate Current for Load Current of 1 Ma .....	45 $\mu$ a
Regulated DC Output Voltage at Zero Load Current .....	25,000 Volts
Regulated DC Output Voltage at Load Current of 1 Ma .....	24,500 Volts

**NOTES:**

- (1) Shield connected directly to ground to minimize the effects of a momentary arc within the tube.
- (2) Peak value for duration of 20 seconds maximum during equipment warm-up.
- (3) Sufficient impedance (1000 ohms is suggested) should be in series with the cathode to limit the cathode current under prolonged heater-cathode short-circuit conditions to 450 Ma. This protective impedance will minimize the danger of heater burnout in case of a momentary heater-cathode arc within the tube.
- (4) With flyback transformer high-voltage supply.

**WARNING:**

X-ray radiation shielding may be necessary to protect against possible danger of personal injury from prolonged exposure at close range if this tube is operated higher than 16,000 volts.

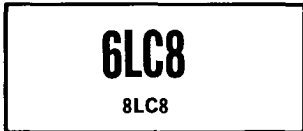

**High Mu Triode and Sharp Cutoff Pentode**

Construction ..... Miniature T-6½  
 Base ..... Button 9 Pin, E9-1  
 Basing ..... 9QY  
 Outline ..... 6-3  
 Maximum Diameter ..... 0.875 In.  
 Maximum Seated Height ..... 2.375 In.  
 Maximum Overall Height ..... 2.625 In.

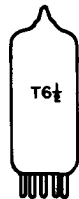
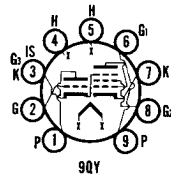

**ELECTRICAL DATA HEATER OPERATION**

	<b>8LC8</b>	<b>6LC8</b>
Heater Voltage .....	8.4	6.3 Volts
Heater Current .....	450	600 Ma
Heater Warm-up Time .....	11	11 Seconds
Maximum Heater-Cathode Voltage		
Heater Negative with Respect to Cathode		
Total DC and Peak .....		200 Volts
Heater Positive with Respect to Cathode		
DC .....		100 Volts
Total DC and Peak .....		200 Volts

**DIRECT INTERELECTRODE CAPACITANCES (Unshielded)**

**Triode Section**

Grid to Plate .....	2.2 Pf
Input: g to (k + h + IS + g3) .....	2.8 Pf
Output: p to (k + h + IS + g3) .....	2.2 Pf

**Pentode Section**

Grid No. 1 to Plate .....	0.1 Pf
Plate to (g3 + Tk + IS) .....	3.4 Pf
Grid No. 1 to (g3 + Tk + IS) .....	0.36 Pf
Grid No. 3, Triode Cathode and IS to (Pp + Pk + g2 + Pg1 + h) .....	12.5 Pf

**RATINGS (Design Maximum Rating System)**

	<b>Triode Section</b>	<b>Pentode Section</b>
Plate Voltage (Max.) .....	300	300 Volts
Peak Positive Pulse Plate Voltage (Max.) <sup>(1)</sup> .....	—	600 Volts
Grid No. 2 Supply Voltage (Max.) .....	—	300 Volts
Grid No. 2 Voltage .....	See Rating Chart (Gen. Info. Sec.)	
Positive Grid No. 3 Voltage (Max.) .....	—	0 Volt
Negative Grid No. 3 Voltage (Max.) .....	—	100 Volts
Positive Grid No. 1 Voltage (Max.) .....	0	0 Volt
Negative Grid No. 1 Voltage (Max.) .....	50	50 Volts

Plate Dissipation (Max.) .....	1.1	2.0 Watts
Grid No. 2 Input (Max.) .....	—	1.1 Watt
Grid No. 1 Circuit Resistance		
Self Bias (Max.) .....	1.0	1.0 Megohm
Fixed Bias (Max.) .....	0.25	0.5 Megohm

**CHARACTERISTICS AND TYPICAL OPERATION**  
**Class A1 Amplifier**

	<b>Triode Section</b>	<b>Pentode Section</b>
Plate Supply Voltage .....	200	150 Volts
Grid No. 2 Voltage .....	—	100 Volts
Grid No. 1 Voltage .....	-2	0 Volt
Cathode Bias Resistor .....	—	180 Ohms
Plate Current .....	4	4 Ma
Grid No. 2 Current .....	—	2.8 Ma
Amplification Factor .....	70	—
Plate Resistance (Approx.) .....	17,500	100,000 Ohms
Transconductance (G1 to P) .....	4000	4400 $\mu$ mhos
Transconductance (G3 to P) .....	—	600 $\mu$ mhos
Ec3 for Ib = 20 $\mu$ a (Approx.) .....	—	-7 Volts
Ec1 for Ib = 10 $\mu$ a (Approx.) .....	-5	— Volts
20 $\mu$ a (Approx.) .....	—	-4 Volts

**NOTE:**

(1) For operation in a 525 line, 30 frame system as described in "Standards of Good Engineering Practice for Television Broadcast Stations; Federal Communications Commission," the duty cycle of the voltage pulse must not exceed 15% of one horizontal scanning cycle.

*Color Television Type*  
**COLOR DEMODULATOR**

**6LE8**  
8LE8, 10LE8, 15LE8

**Twin Pentode**

Construction ..... Miniature T-6½  
Base ..... Button 9 Pin, E9-1  
Basing ..... .9QZ  
Outline ..... 6-4  
  Maximum Diameter ..... 0.875 In.  
  Maximum Seated Height ..... 2.812 In.  
  Maximum Overall Height ..... 3.062 In.

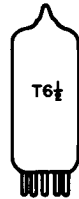
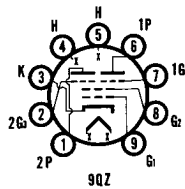

**ELECTRICAL DATA**  
**HEATER OPERATION**

	<b>15LE8</b>	<b>10LE8</b>	<b>8LE8</b>	<b>6LE8</b>
Heater Voltage .....	15.0	10.0	8.0	6.3 Volts
Heater Current .....	300	450	600	760 Ma
Heater Warm-up Time .....	11	11	11	— Seconds
Maximum Heater-Cathode Voltage				
Heater Negative with Respect to Cathode				
Total DC and Peak .....				300 Volts
Heater Positive with Respect to Cathode				
DC .....				100 Volts
Total DC and Peak .....				200 Volts

**DIRECT INTERELECTRODE CAPACITANCES**

Grid No. 3 to Plate (Each Section) .....	2.7 Pf
Grid No. 1 to All .....	15.5 Pf
Grid No. 3 to All (Each Section) .....	6.0 Pf
Plate to All (Each Section) .....	3.7 Pf
Grid No. 3 (Section 1) to Grid No. 3 (Section 2) .....	0.1 Pf

**RATINGS (Design Maximum Rating System)**

Plate Voltage (Each Section) (Max.) .....	300 Volts
Grid No. 2 Voltage (Max.) .....	150 Volts
Plate Dissipation (Each Section) (Max.) .....	2 Watts
Grid No. 2 Dissipation (Max.) .....	2 Watts

**CHARACTERISTICS AND TYPICAL OPERATION (Each Section)**

**Grid No. 1 Control**

Plate Voltage .....	100 Volts
Grid No. 2 Voltage .....	100 Volts
Grid No. 1 Voltage .....	-2.5 Volts
Grid No. 3 Voltage .....	0 Volt
Plate Current (Approx.) .....	8.0 Ma
Grid No. 2 Current (Approx.) .....	15.0 Ma
Transconductance (Approx.) .....	5800 $\mu$ mhos

Plate Resistance (Approx.) .....	50,000 Ohms
Grid No. 1 Voltage for $I_b = 20 \mu a$ .....	-7.2 Volts
Grid No. 1 Voltage for $I_b = 100 \mu a$ .....	-6.3 Volts
<b>Grid No. 3 Control</b>	
Plate Voltage .....	100 Volts
Grid No. 2 Voltage .....	100 Volts
Grid No. 1 Voltage .....	-2.5 Volts
Grid No. 3 Voltage .....	0 Volt
Plate Current .....	7.5 Ma
Grid No. 2 Current .....	14.5 Ma
Transconductance .....	350 $\mu mhos$
Plate Resistance .....	50,000 Ohms
Grid No. 3 Voltage for $I_b = 20 \mu a^{(1)}$ .....	-17.4 Volts
Grid No. 3 Voltage for $I_b = 100 \mu a^{(1)}$ .....	-16.5 Volts

**NOTE:**

(1) Measured with -3.0 volts on Grid No. 1 to maintain Grid No. 2 within dissipation rating.



**Beam Pentode**

Construction.....	Compactron T-12
Base .....	E12-74
Top Cap .....	C1-1
Basing .....	12GW
<b>Outline</b>	
Maximum Diameter .....	1.563 In.
Maximum Seated Height .....	4.570 In.
Maximum Overall Height .....	4.950 In.

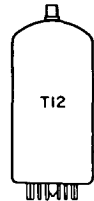
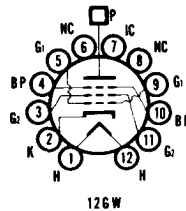

**ELECTRICAL DATA**

**HEATER OPERATION**

Heater Voltage .....	6.3 Volts
Heater Current .....	2.0 Amp.

**DIRECT INTERELECTRODE CAPACITANCES (Unshielded)**

Grid to Plate .....	3.0 pf
Input: $g_1$ to ( $h + k + g_2 + bp$ ).....	37 pf
Output: $p$ to ( $h + k + g_2 + bp$ ).....	18.5 pf

**RATINGS (Design Maximum Rating System)**

**Horizontal Deflection Amplifier**

DC Plate Supply Voltage at Zero Current (Max.) .....	990 Volts
Peak Positive Plate Voltage <sup>(1)</sup> (Max.) .....	8000 Volts
Beam Plate Voltage (Max.) .....	50 Volts
Grid No. 2 Voltage (Max.) .....	275 Volts
Peak Negative Grid No. 1 Voltage (Max.) .....	550 Volts
Plate Dissipation (Max.) .....	40 Watts
Peak Cathode Current (Max.).....	1400 Ma
Beam Plate Circuit Resistance (Max.) .....	0.01 Megohms
Bulb Temperature (At Hottest Point) (Max.) .....	300 °C

**AVERAGE CHARACTERISTICS (Measured Under Pulse Conditions)**

	Max.	Min.	During Flyback
Plate Voltage .....	160	50	7000 Volts
Grid No. 2 Voltage .....	160	175	175 Volts
Grid No. 1 Voltage .....	0	-10	-185 Volts
Beam Plate Voltage .....	Tied to Cathode		
Plate Current .....	1400	800	<0.05 Ma
Grid No. 2 Current .....	45	70	— Ma

**NOTE:**

(1) Maximum pulse duration is 22% of a cycle, maximum 18  $\mu sec$ .

Color Television Type

## VIDEO AMPLIFIER (T) GENERAL PURPOSE AMPLIFIER (P)

# 6LF8

**High Mu Triode and Sharp Cutoff Pentode**

Construction ..... Miniature T-6½  
 Base ..... Button 9 Pin, E9-1  
 Basing ..... 9DX  
 Outline ..... 6-3  
     Maximum Diameter ..... 0.875 In.  
     Maximum Seated Height ..... 2.375 In.  
     Maximum Overall Height ..... 2.625 In.

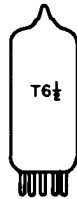
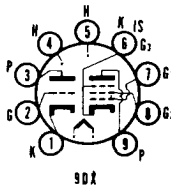

**ELECTRICAL DATA  
HEATER OPERATION**

Heater Voltage.....	6.3 Volts
Heater Current.....	600 Ma
Heater Warm-up Time.....	11 Seconds
Maximum Heater-Cathode Voltage	
Heater Negative with Respect to Cathode	
Total DC and Peak.....	200 Volts
Heater Positive with Respect to Cathode	
DC.....	100 Volts
Total DC and Peak.....	200 Volts

**DIRECT INTERELECTRODE CAPACITANCES (Unshielded)**

**Triode Section**

Grid to Plate.....	2.2 Pf
Input: g to (h + Tk + Pk, g3, IS).....	3.2 Pf
Output: p to (h + Tk + Pk, g3, IS).....	1.8 Pf

**Pentode Section**

Grid No. 1 to Plate (Max.).....	0.06 Pf
Input: g1 to (h + Pk, g3, IS + g2).....	10 Pf
Output: p to (h + Pk, g3, IS + g2).....	3.6 Pf

**Coupling**

Pentode Plate to Triode Plate (Max.).....	0.150 Pf
Pentode Grid No. 1 to Triode Plate (Max.).....	0.008 Pf

**RATINGS (Design Maximum Rating System)**

	Triode Section	Pentode Section
Plate Voltage (Max.).....	330	330 Volts
Grid No. 2 Supply Voltage (Max.).....	—	330 Volts
Grid No. 2 Voltage.....	See Rating Chart (Gen. Info. Sec.)	
Plate Dissipation (Max.).....	1.1	3.75 Watts
Grid No. 2 Dissipation (Up to Ec2 = 165 V) (Max.).....	—	1.1 Watt
Above 165 V.....	See Rating Chart (Gen. Info. Sec.)	
Positive Grid No. 1 Voltage (Max.).....	4	0 Volts
Negative Grid No. 1 Voltage (Max.).....	55	55 Volts
Grid No. 1 Current.....	8	0 Ma
Grid No. 1 Circuit Resistance		
Fixed Bias (Max.).....	0.5	0.25 Megohm
Self Bias (Max.).....	1.0	1.0 Megohm

**CHARACTERISTICS AND TYPICAL OPERATION**

**Class A1 Amplifier**

	Triode Section	Pentode Section
Plate Voltage.....	200	40
Grid No. 2 Voltage.....	—	—
Grid No. 1 Voltage.....	-2	3
Plate Current.....	4.0	11
Grid No. 2 Current.....	—	—
Grid No. 1 Current.....	0	2.7
Transconductance.....	4000	4000
Amplification Factor.....	70	40
Plate Resistance (Approx.).....	17,500	10,000
Ec for Ib = 20 µa (Approx.).....	-5	—

**INSTANTANEOUS PLATE KNEE CHARACTERISTICS**

Eb = 65 V, Ec2 = 150 V, Ec1 = 0 V  
 Ib = 60 Ma, Ic2 = 20 Ma

# 6LJ8

5LJ8, 4LJ8

Color Television Type

## VHF OSCILLATOR and MIXER

**Medium Mu Triode and Sharp Cutoff Pentode**

Construction ..... Miniature T-6½  
 Base ..... Button 9 Pin, E9-1  
 Basing ..... 9GF  
 Outline ..... 6-2  
 Maximum Diameter ..... 0.875 In.  
 Maximum Seated Height ..... 1.938 In.  
 Maximum Overall Height ..... 2.188 In.

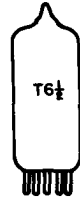
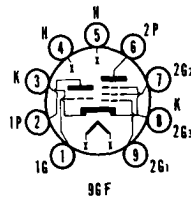

**ELECTRICAL DATA HEATER OPERATION**

	<b>4LJ8</b>	<b>5LJ8</b>	<b>6LJ8</b>
Heater Voltage.....	4.3	5.6	6.3 Volts
Heater Current .....	600	450	400 Ma
Heater Warm-up Time .....	11	11	— Seconds
Maximum Heater-Cathode Voltage			
Heater Negative with Respect to Cathode			
Total DC and Peak.....			200 Volts
Heater Positive with Respect to Cathode			
DC .....			100 Volts
Total DC and Peak.....			200 Volts

**DIRECT INTERELECTRODE CAPACITANCES**

**Triode Section**

Grid to Plate .....	1.4 Pf
Input: g1 to (k + Pg3 + IS + h) .....	2.4 Pf
Output: p to (k + Pg3 + IS + h) .....	2.0 Pf

**Pentode Section**

Grid No. 1 to Plate (Max.).....	0.015 Pf
Input: g1 to (k + g3 + IS + g2 + h) .....	5.5 Pf
Output: p to (k + g3 + IS + g2 + h).....	3.4 Pf

**RATINGS (Design Maximum Rating System)**

	<b>Tri. Sec.</b>	<b>Pent. Sec.</b>
Plate Voltage (Max.) .....	280	280 Volts
Grid No. 2 Supply Voltage (Max.) .....	—	280 Volts
Grid No. 2 Voltage .....	See Rating Chart (Gen. Info. Sec.)	
Cathode Current (Max.) .....	20	20 Ma
Plate Dissipation (Max.) .....	2.0	2.0 Watts
Grid No. 2 Dissipation (Max.) .....	—	0.5 Watt
Positive Grid No. 1 Voltage (Max.) .....	0	0 Volt
Maximum Grid No. 1 Circuit Resistance		
Self Bias (Max.) .....	0.5	0.25 Megohm
Fixed Bias (Max.) .....	1.0	0.5 Megohm

Control grid to cathode spacing of the pentode section of this type is of such low order of magnitude as to preclude the use of voltage between these elements of more than 30 Volts DC or peak AC in commercial tube checkers and shorts indicating devices, particularly where mechanical excitation of the tube is employed.

**CHARACTERISTICS AND TYPICAL OPERATION**

**Class A1 Amplifier**

	<b>Tri. Sec.</b>	<b>Pent. Sec.</b>
Plate Voltage .....	125	125 Volts
Grid No. 2 Voltage .....	—	125 Volts
Grid No. 1 Voltage .....	0	0 Volt
Cathode Bias Resistor .....	68	33 Ohms
Plate Current .....	13	12 Ma
Grid No. 2 Current .....	—	3.5 Ma
Transconductance .....	8000	13,000 μmhos
Amplification Factor .....	40	—
Plate Resistance (Approx.) .....	5000	125,000 Ohms
Ec1 for Ib = 30 μa (Approx.) .....	-6.5	-4 Volts

**NOTE:**

(1) Each tube section measured separately and with cathode bias resistor indicated. Section not under test is floating.

**AVERAGE PLATE CHARACTERISTICS (Pentode Section)**

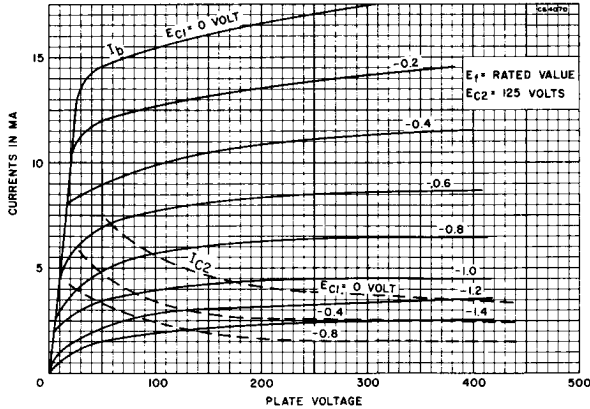

*Color Television Type*

**BURST AMPLIFIER (P)  
GENERAL PURPOSE AMPLIFIER (T)**

**6LM8**

**Medium Mu Triode and Semi-Remote Cutoff Pentode**

- Construction ..... Miniature T-6½
- Base ..... Button 9 Pin, E9-1
- Basing ..... 9AE
- Outline ..... 6-2
- Maximum Diameter ..... 0.875 In.
- Maximum Seated Height ..... 1.937 In.
- Maximum Overall Height ..... 2.187 In.

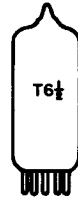
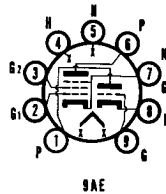

**ELECTRICAL DATA  
HEATER OPERATION**

	Series	Parallel
Heater Voltage.....	6.3	6.3 Volts
Heater Current .....	450	450 Ma
Heater Warm-up Time .....	11	— Sec.
<b>Maximum Heater-Cathode Voltage</b>		
Heater Negative with Respect to Cathode		
Total DC and Peak.....		200 Volts
Heater Positive with Respect to Cathode		
DC .....		100 Volts
Total DC and Peak.....		200 Volts

**DIRECT INTERELECTRODE CAPACITANCES (Shielded)<sup>(1)</sup>**

<b>Triode Section</b>	
Grid to Plate .....	1.8 Pf
Input: Tg to (Tk, Pk + Pg3 + IS, H) .....	3.2 Pf
Output: Tp to (Tk, Pk + Pg3 + IS, H) .....	1.9 Pf
<b>Pentode Section</b>	
Grid to Plate (Max.).....	0.015 Pf
Input: Pg1 to (Pk + Pg3 + IS, Pg2, H) .....	5.5 Pf
Output: Pp to (Pk + Pg3 + IS, Pg2, H) .....	3.8 Pf
Heater to Cathode (Each Section) .....	3.2 Pf

**RATINGS (Design Maximum Rating System)**

	Triode Section	Pentode Section
Plate Voltage (Max.) .....	330	350 Volts
Grid No. 2 (Screen-Grid) Supply Voltage (Max.) .....	—	330 Volts
Grid No. 2 Voltage .....	See Rating Chart (Gen. Info. Sec.)	
<b>Grid No. 1 (Control-Grid) Voltages:</b>		
Positive-Bias Value (Max.) .....	0	0 Volt

Grid No. 2 Input:		
For Grid No. 2 Voltages up to 165 Volts (Max.)	—	0.55 Watt
For Grid No. 2 Voltages Between 165 and 330 Volts	See Rating Chart (Gen. Info. Sec.)	
Plate Dissipation (Max.)	2.5	2.5 Watts
Grid No. 1 Circuit Resistance		
For Fixed Bias Operation (Max.)	0.5	0.25 Megohm
For Cathode Bias Operation (Max.)	1.0	0.5 Megohm

**CHARACTERISTICS AND TYPICAL OPERATION**

**Class A1 Amplifier**

	Triode Section	Pentode Section
Plate Voltage	125	125 Volts
Grid No. 2 Voltage	—	125 Volts
Grid No. 1 Voltage	-1	-2 Volts
Amplification Factor	46	—
Plate Resistance (Approx.)	5400	150,000 Ohms
Transconductance	8500	6000 $\mu$ mhos
Plate Current	13.5	12 Ma
Grid No. 2 Current	—	4 Ma
Grid No. 1 Voltage (Approx.) for Plate $\mu$ a = 10	-8	-14 Volts

**NOTE:**

(1) Shield No. 315.



**Medium Mu Triode and Sharp Cutoff Pentode**

Construction	Miniature T-6½
Base	Button 9 Pin, E9-1
Basing	9DX
Outline	6-3
Maximum Diameter	0.875 In.
Maximum Seated Height	2.375 In.
Maximum Overall Height	2.625 In.

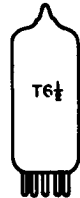
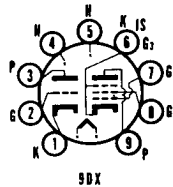

**ELECTRICAL DATA**  
**HEATER OPERATION**

	11LQ8	6LQ8
Heater Voltage	10.9	6.3 Volts
Heater Current	450	775 Ma
Heater Warm-up Time	11	— Seconds
Heater Negative with Respect to Cathode		
Total DC and Peak		200 Volts
Heater Positive with Respect to Cathode		
DC		100 Volts
Total DC and Peak		200 Volts

**DIRECT INTERELECTRODE CAPACITANCES (Unshielded)**

**Triode Section**

Grid to Plate	2.8 Pf
Input: Tg to (Tk, Pk + Pg3 + IS + H)	4.2 Pf
Output: Tp to (Tk, Pk + Pg3 + IS + H)	2.4 Pf

**Pentode Section**

Grid No. 1 to Plate (Max.)	0.12 Pf
Input: Pg1 to (Pk + Pg3 + IS, Pg2, H)	14 Pf
Output: Pp to (Pk + Pg3 + IS, Pg2, H)	4.8 Pf
Triode Grid to Pentode Plate (Max.)	0.015 Pf
Pentode Plate to Triode Plate (Max.)	0.17 Pf

**RATINGS (Design Maximum Rating System)**

**Class A1 Amplifier**

	Triode Section	Pentode Section
DC Plate Voltage	300	300 Volts
DC Grid No. 2 Supply Voltage	—	300 Volts
DC Grid No. 2 Voltage	See Rating Chart (Gen. Info. Sec.)	
DC Grid No. 1 Voltage:		
Positive Bias Value	0	0 Volt



Grid No. 2 Input:		
For Ec2 up to 150 V .....	—	1 Watt
For Ec2 from 150 V to 300 V .....	See Rating Chart (Gen. Info. Sec.)	
Plate Dissipation .....	2	5 Watts
Grid No. 1 Circuit Resistance		
Fixed Bias .....	0.5	0.1 Megohm
Cathode Bias .....	1	0.25 Megohm

**CHARACTERISTICS AND TYPICAL OPERATION**

	Triode Section	Pentode Section	
DC Plate Supply Voltage .....	125	125	200 Volts
DC Grid No. 2 Supply Voltage .....	—	125	125 Volts
Grid No. 1 .....	Connected to Negative End of Rk		
Cathode Resistor .....	68	82	68 Ohms
Amplification Factor .....	46	—	—
Plate Resistance (Approx.) .....	4400	55,000	75,000 Ohms
Transconductance .....	10,400	21,000	23,000 $\mu$ mhos
DC Plate Current .....	15	16.5	20 Ma
DC Grid No. 2 Current .....	—	3.1	3.5 Ma
Cutoff DC Grid No. 1 Voltage for Ib = 100 $\mu$ a .....	-6	-4.2	-4.2 Volts

**VERTICAL DEFLECTION  
OSCILLATOR and AMPLIFIER**

**6LR8**  
21LR8

**High Mu Triode and Beam Power Pentode**

Construction .....	Novar T-12
Base .....	Button 9 Pin, E9-76
Basing .....	.9QT
Outline .....	12-65
Maximum Diameter .....	1.562 In.
Maximum Seated Height .....	3.330 In.
Maximum Overall Height .....	3.710 In.

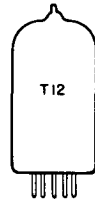
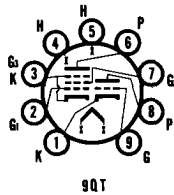

**ELECTRICAL DATA  
HEATER OPERATION**

	21LR8	6LR8
Heater Voltage .....	21	6.3 Volts
Heater Current .....	450	1500 Ma
Heater Warm-up Time .....	11	— Seconds
Maximum Heater-Cathode Voltage		
Heater Negative with Respect to Cathode		200 Volts
Heater Positive with Respect to Cathode		100 Volts
DC		200 Volts
Total DC and Peak .....		

**DIRECT INTERELECTRODE CAPACITANCES (Unshielded)**

Triode Section		
Grid to Plate .....		6.0 Pf
Input .....		6.5 Pf
Output .....		1.6 Pf
Pentode Section		
Grid No. 1 to Plate (Max.) .....		0.70 Pf
Input .....		16.0 Pf
Output .....		9.0 Pf
Coupling		
Pentode Grid No. 1 to Triode Plate (Max.) .....		0.12 Pf
Pentode Plate to Triode Plate (Max.) .....		0.32 Pf

**RATINGS (Design Maximum Rating System)  
Vertical Deflection Oscillator and Amplifier<sup>(1)</sup>**

	Triode Osc.	Pentode Amp.
Plate Voltage (Max.) .....	400	400 Volts
Grid No. 2 Voltage (Max.) .....	—	300 Volts
Peak Positive Pulse Plate Voltage (Max.) .....	—	2500 Volts
Peak Negative Grid No. 1 Voltage (Max.) .....	400	250 Volts
Plate Dissipation (Max.) <sup>(2)</sup> .....	2.5	14 Watts
Grid No. 2 Dissipation (Max.) <sup>(2)</sup> .....	—	2.75 Watts
Average Cathode Current (Max.) .....	30	75 Ma
Peak Cathode Current (Max.) .....	105	260 Ma

Peak Power Output (Max.) .....	2.5	— Watts
Grid Circuit Resistance		
Self Bias (Max.) .....	2.2	2.2 Megohms
Fixed Bias (Max.) .....	—	1.0 Megohm
Bulb Temperature .....	—	210 °C

**CHARACTERISTICS AND TYPICAL OPERATION**

	Triode Section	Pentode Section
Plate Voltage .....	250	135 Volts
Grid No. 2 Voltage .....	—	120 Volts
Grid No. 1 Voltage .....	-4	-10 Volts
Plate Current .....	2.3	56 Ma
Grid No. 2 Current .....	—	3 Ma
Transconductance .....	3600	9300 $\mu$ mhos
Amplification Factor .....	58	6.5 <sup>(1)</sup>
Plate Resistance (Approx.) .....	16,000	12,000 Ohms
Ec for Ib = 10 $\mu$ a .....	-6.6	— Volts
Ec for Ib = 1 Ma (Approx.) .....	—	-26 Volts
Ec for Ib = 100 $\mu$ a .....	—	-30 Volts

**INSTANTANEOUS PLATE KNEE VALUES**

Eb = 45 V; Ec2 = 125 V; and Ec = 0 V  
Ib = 200 Ma, and Ic2 = 20 Ma

**NOTES:**

- (1) For operation in a 525 line, 30 frame system as described in "Standards of Good Engineering Practice for Television Broadcast Stations; Federal Communications Commission," the duty cycle of the voltage pulse must not exceed 15% of one horizontal scanning cycle.
- (2) In stages operating with grid leak bias, an adequate cathode bias resistor or other suitable means is required to protect the tube in the absence of excitation.
- (3) Measured with Eb = 120 V, Ec2 = 120 V and Ec1 = -10 V.

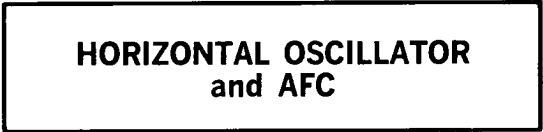

**Double Diode and Pentode**

Construction ..... Miniature T-6½  
Base ..... Button 9 Pin, E9-1  
Basing ..... 9RL  
Outline ..... 6-2  
  Maximum Diameter ..... 0.875 In.  
  Maximum Seated Height ..... 1.937 In.  
  Maximum Overall Height ..... 2.187 In.

**ELECTRICAL DATA  
HEATER OPERATION**

	11LT8	8LT8	6LT8
Heater Voltage .....	11.4	8.1	6.3 Volts
Heater Current .....	315	450	600 Ma
Heater Warm-up Time .....	11	11	11 Seconds
Maximum Heater-Cathode Voltage			
Heater Negative with Respect to Cathode			
Total DC and Peak .....			200 Volts
Heater Positive with Respect to Cathode			
DC .....			100 Volts
Total DC and Peak .....			200 Volts

**DIRECT INTERELECTRODE CAPACITANCES (Unshielded)**

<b>Pentode Section</b>		
Grid No. 1 to Plate .....		0.065 Pf
Input: Pg1 to (h + Pk + Pg2 + Pg3 + IS) .....		11 Pf
Output: Pp to (h + Pk + Pg2 + Pg3 + IS) .....		3.6 Pf
<b>Diode Sections</b>		
Plate (Section 1) to Cathode .....		1.4 Pf
Plate (Section 2) to Cathode .....		1.4 Pf
Plate to Plate .....		1.4 Pf

**RATINGS (Design Maximum Rating System)**

<b>Pentode Section</b>		
Plate Voltage .....		330 Volts
Screen Supply Voltage .....		330 Volts
Screen Voltage .....	See Rating Chart (See Info. Sec.)	
Positive DC Grid No. 1 Voltage .....		0 Volt
Plate Dissipation .....		3.1 Watts
Screen Dissipation .....		0.65 Watts
Grid No. 1 Circuit Resistance (Cathode Bias) .....		1.0 Megohm

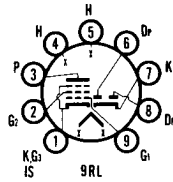

**Diode Section**  
 Diode Current for Continuous Operation (Each Diode)..... 5.0 Ma

**CHARACTERISTICS AND TYPICAL OPERATION**

**Pentode Section**

Plate Voltage ..... 125 Volts  
 Screen Voltage ..... 125 Volts  
 Cathode-Bias Resistor ..... 56 Ohms  
 Plate Resistance (Approx.) ..... 200,000 Ohms  
 Transconductance ..... 13,000  $\mu$ mhos  
 Plate Current ..... 10 Ma  
 Screen Current ..... 3.4 Ma  
 Grid No. 1 Voltage (Approx.)  $I_b = 20 \mu$ a ..... -3.5 Volts

**Diode Section**

Average Diode Current Each Diode with 5 Volts DC Applied ..... 20 Ma

*Color Television Type*

**VERTICAL DEFLECTION  
 OSCILLATOR and AMPLIFIER**

**6LU8**  
 16LU8, 21LU8

**High Mu Triode and  
 Beam Power Pentode**

Construction ..... Compactron T-12  
 Base ..... Button 12 Pin, E12-74  
 Basing ..... 12DZ  
 Outline ..... 12-57  
 Maximum Diameter ..... 1.562 In.  
 Maximum Seated Height ..... 2.750 In.  
 Maximum Overall Height ..... 3.125 In.

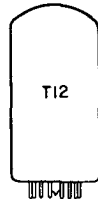
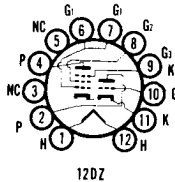

**ELECTRICAL DATA**

**HEATER OPERATION**

	<b>21LU8</b>	<b>16LU8</b>	<b>6LU8</b>
Heater Voltage.....	21	15.8	6.3 Volts
Heater Current .....	450	600	1500 Ma
Heater Warm-up Time .....	11	11	— Seconds
Maximum Heater-Cathode Voltage			
Heater Negative with Respect to Cathode			
Total DC and Peak.....	200 Volts		
Heater Positive with Respect to Cathode			
DC .....	100 Volts		
Total DC and Peak.....	200 Volts		

**DIRECT INTERELECTRODE CAPACITANCES (Unshielded)**

**Triode Section**

Grid to Plate:  $t_g$  to  $t_p$  ..... 6.0 Pf  
 Input:  $t_g$  to ( $h + T_k$ ) ..... 7.0 Pf  
 Output:  $t_p$  to ( $h + T_k$ ) ..... 2.0 Pf

**Pentode Section**

Grid No. 1 to Plate:  $pg_1$  to  $pp$  ..... 0.5 Pf  
 Input:  $pg_1$  to ( $h + P_k + P_g2$ ) ..... 16 Pf  
 Output:  $pp$  to ( $h + P_k + P_g2$ ) ..... 9.0 Pf

**Coupling**

Pentode Grid No. 1 to Triode Plate (Max.) ..... 0.13 Pf  
 Pentode Plate to Triode Plate (Max.) ..... 0.40 Pf

**RATINGS (Design Maximum Rating System)**

**Vertical Deflection Oscillator and Amplifier<sup>(1)</sup>**

	<b>Triode Osc.</b>	<b>Pentode Amp.</b>
Plate Voltage (Max.) .....	400	400 Volts
Grid No. 2 Voltage (Max.) .....	—	300 Volts
Peak Positive Pulse Plate Voltage (Max.) .....	—	2500 Volts
Peak Negative Grid No. 1 Voltage (Max.) .....	400	250 Volts
Plate Dissipation (Max.) <sup>(2)</sup> .....	2.5	14 Watts
Grid No. 2 Dissipation (Max.) .....	—	2.75 Watts
Average Cathode Current (Max.).....	30	75 Ma
Peak Cathode Current (Max.) .....	105	260 Ma
Grid Circuit Resistance		
Self Bias (Max.) .....	2.2	2.2 Megohms
Fixed Bias (Max.) .....	—	1.0 Megohm
Bulb Temperature (Max.) .....	—	210 °C

**CHARACTERISTICS AND TYPICAL OPERATION**

	<b>Triode Section</b>	<b>Pentode Section</b>
Plate Voltage .....	250	135 Volts
Grid No. 2 Voltage .....	—	120 Volts
Grid No. 1 Voltage .....	-4	-10 Volts
Plate Current .....	2.3	56 Ma
Grid No. 2 Current .....	—	3 Ma
Transconductance .....	3600	9300 $\mu$ mhos
Amplification Factor .....	58	6.5 <sup>(3)</sup>
Plate Resistance (Approx.) .....	16,000	12,000 Ohms
Ec for Ib = 10 $\mu$ a .....	-6.6	— Volts
Ec for Ib = 1 Ma (Approx.) .....	—	-26 Volts
Ec for Ib = 100 $\mu$ a .....	—	-30 Volts

**INSTANTANEOUS PLATE KNEE VALUES**

Eb = 45 V; Ec2 = 125 V; and Ec = 0 V  
Ib = 200 Ma, and Ic2 = 20 Ma

**NOTES:**

- (1) For operation in a 525 line, 30 frame system as described in "Standards of Good Engineering Practice for Television Broadcast Stations; Federal Communications Commission," the duty cycle of the voltage pulse must not exceed 15% of one horizontal scanning cycle.
- (2) In stages operating with grid leak bias, an adequate bias resistor or other suitable means is required to protect the tube in the absence of excitation.
- (3) Measured with Eb = 120 V, Ec2 = 120 V, and Ec1 = -10 V.

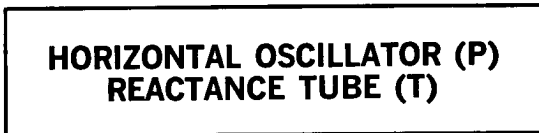

**Triode and Pentode**

Construction ..... Miniature T-6½  
Base ..... Button 9 Pin, E9-1  
Basing ..... 9DC  
Outline ..... 6-2  
Maximum Diameter ..... 0.875 In.  
Maximum Seated Height ..... 1.937 In.  
Maximum Overall Height ..... 2.187 In.

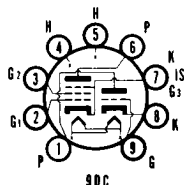

**ELECTRICAL DATA**

**HEATER OPERATION**

Heater Voltage .....	6.0 Volts
Heater Current .....	450 Ma
Heater Warm-up Time .....	11 Seconds
Maximum Heater-Cathode Voltage .....	100 Volts

**DIRECT INTERELECTRODE CAPACITANCES**

**Pentode Section**

Grid No. 1 .....	5.4 Pf
Plate to Grid No. 1 .....	0.060 Pf
Grid No. 1 to Filament .....	0.1 Pf

**Triode Section**

Grid .....	2.4 Pf
Plate to Grid .....	1.5 Pf
Grid to Filament .....	0.1 Pf

**RATINGS (Design Center Rating System)**

**Pentode Section**

Plate Voltage, Zero Plate Current (Max.) .....	550 Volts
Plate Voltage (Max.) .....	250 Volts
Plate Dissipation (Max.) .....	1.2 Watts
Grid No. 2 Voltage, Zero Plate Current (Max.) .....	550 Volts
Grid No. 2 Voltage (Max.) .....	250 Volts
Grid No. 2 Dissipation (Max.) .....	0.8 Watt
Grid No. 1 Circuit Resistance (Fixed Bias) (Max.) .....	0.56 Megohm
Grid No. 1 Circuit Resistance (Self Bias) (Max.) .....	1.0 Megohm
Cathode Current (Max.) .....	15 Ma
Peak Cathode Current (Max.) <sup>(1)</sup> .....	50 Ma
Input Impedance at 60 Hertz (Max.) .....	300 K Ohms

**Triode Section**

Plate Voltage, Zero Plate Current (Max.) .....	550 Volts
Plate Voltage (Max.) .....	250 Volts
Plate Dissipation (Max.) .....	1.4 Watts

Grid No. 1 Circuit Resistance (Max.) .....	3 Megohms
Cathode Current (Max.) .....	10 Ma
Input Impedance at 60 Hertz (Max.) .....	50 K Ohms

**CHARACTERISTICS AND TYPICAL OPERATION**

**Pentode Section**

Plate Voltage .....	100 Volts
Grid No. 2 Voltage .....	100 Volts
Grid No. 1 Voltage .....	-1 Volt
Plate Current .....	6 Ma
Grid No. 2 Current .....	1.7 Ma
Transconductance .....	5500 $\mu$ mhos
Input Resistance .....	0.4 Megohm
Amplification Factor (Grid No. 1 to Grid No. 2) .....	47
Plate Current ( $E_{g1} = 0$ V) .....	12.5 Ma
Grid No. 2 Current ( $E_{g1} = 0$ V) .....	3.5 Ma
Grid No. 1 Voltage ( $E_b = E_{g2} = 200$ V, $I_b = 10$ $\mu$ a) .....	-16 Volts
Grid No. 1 Voltage ( $I_{c1} = +0.3$ $\mu$ a) .....	-1.3 Volts

**Triode Section**

Plate Voltage .....	200 Volts
Grid Voltage .....	-2 Volts
Plate Current .....	3.5 Ma
Transconductance .....	3500 $\mu$ mhos
Input Resistance .....	20 K Ohms
Amplification Factor .....	70
Plate Current ( $I_c = 10$ $\mu$ a) .....	10 Ma
Grid Voltage ( $I_c = +0.3$ $\mu$ a) .....	-1.3 Volts

**NOTE:**

(1) Duty cycle 30% maximum; pulse time 30  $\mu$ sec. maximum.

<p>Color Television Type</p> <p><b>VIDEO AMPLIFIER (P)</b></p> <p><b>GENERAL PURPOSE AMPLIFIER (T)</b></p>	<p><b>6LY8</b></p> <p>10LY8</p>
--	---------------------------------

**High Mu Triode and Sharp Cutoff Pentode**

Construction .....	Miniature T-6 $\frac{1}{2}$
Base .....	Button 9 Pin, E9-1
Basing .....	9DX
Outline .....	6-3
Maximum Diameter .....	0.875 in.
Maximum Seated Height .....	2.375 in.
Maximum Overall Height .....	2.625 in.

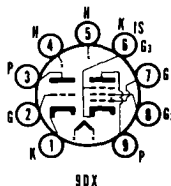

**ELECTRICAL DATA**  
**HEATER OPERATION**

	10LY8	6LY8
Heater Voltage .....	10.5	6.3 Volts
Heater Current .....	450	750 Ma
Heater Warm-up Time .....	11	— Seconds
Maximum Heater-Cathode Voltage		
Heater Negative with Respect to Cathode		
Total DC and Peak .....		200 Volts
Heater Positive with Respect to Cathode		
DC .....		100 Volts
Total DC and Peak .....		200 Volts

**DIRECT INTERELECTRODE CAPACITANCES (Unshielded)**

<b>Pentode Section</b>		
Grid No. 1 to Plate .....		0.075 Pf
Input: P <sub>g1</sub> to (h + P <sub>k</sub> + P <sub>g2</sub> + P <sub>g3</sub> + IS) .....		13 Pf
Output: P <sub>p</sub> to (h + P <sub>k</sub> + P <sub>g2</sub> + P <sub>g3</sub> + IS) .....		4.4 Pf
<b>Triode Section</b>		
Grid to Plate .....		3.8 Pf
Input: T <sub>g</sub> to (h + T <sub>k</sub> + P <sub>k</sub> + P <sub>g3</sub> + IS) .....		2.6 Pf
Output: T <sub>p</sub> to (h + T <sub>k</sub> + P <sub>k</sub> + P <sub>g3</sub> + IS) .....		2.8 Pf

**RATINGS (Design Maximum Rating System)**

	Pentode Section	Triode Section
Plate Voltage (Max.) .....	330	330 Volts
Screen Supply Voltage (Max.) .....	330	— Volts
Screen Voltage .....	See Rating Chart (Gen. Info. Sec.)	
Positive DC Grid No. 1 Voltage (Max.) .....	0	0 Volt
Plate Dissipation (Max.) .....	5.0	1.0 Watts
Screen Dissipation (Max.) .....	1.1	— Watts

Grid No. 1 Circuit Resistance		
Fixed Bias (Max.)	0.5	0.5 Megohm
Cathode Bias (Max.)	1.0	1.0 Megohm

**CHARACTERISTICS AND TYPICAL OPERATION**

	<b>Pentode Section</b>	<b>Triode Section</b>
Plate Voltage	35 200	250 Volts
Screen Voltage	100 100	— Volts
Grid No. 1 Voltage	0 —	-2.0 Volts
Cathode Bias Resistor	— 82	— Ohms
Amplification Factor	— —	100
Plate Resistance (Approx.)	— 60,000	59,000 Ohms
Transconductance	— 20,000	1700 $\mu$ mhos
Plate Current	54 19.5	1.0 Ma
Screen Current	13.5 3.0	— Ma
Grid Voltage (Approx.) $I_b = 10 \mu a$	— —	-5 Volts
Grid No. 1 Voltage (Approx.) $I_b = 100 \mu a$	— -6.3	— Volts



Color Television Type  
**SYNC SEP. and AGC AMP. (T)  
 IF AMPLIFIER (P)**

**Double High Mu Triode and Sharp Cutoff Pentode**

Construction.....Compactron T-9  
 Base ..... Button 12 Pin, E12-70  
 Basing ..... 12CA  
 Outline ..... 9-58  
 Maximum Diameter .....1.188 In.  
 Maximum Seated Height ..... 2.000 In.  
 Maximum Overall Height .....2.375 In.

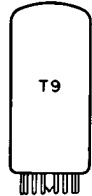
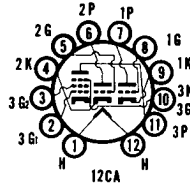

**ELECTRICAL DATA**

**HEATER OPERATION**

Heater Voltage	6.3 Volts
Heater Current	750 Ma
Maximum Heater-Cathode Voltage	
Heater Negative with Respect to Cathode	
Total DC and Peak	200 Volts
Heater Positive with Respect to Cathode	
DC	100 Volts
Total DC and Peak	200 Volts

**DIRECT INTERELECTRODE CAPACITANCES (Unshielded)**

**Triode (Each Section)**

Grid to Plate	1.8 Pf
Input: Tg to (Tk + Pk + Pg3 + h + IS)	3.8 Pf
Output: Tp to (Tk + Pk + Pg3 + h + IS)	1.1 Pf

**Pentode Section**

Grid No. 1 to Plate	0.028 Pf
Input: Pg1 to (Pk + Pg2 + Pg3 + IS)	11.5 Pf
Output: Pp to (Pk + Pg2 + Pg3 + IS)	2.8 Pf

**RATINGS (Design Maximum Rating System)**

	<b>Pentode Section</b>	<b>Each Triode Section</b>
Plate Voltage (Max.)	330	330 Volts
Screen Supply Voltage (Max.)	330	— Volts
Screen Voltage	See Rating Chart (Gen. Info. Sec.)	
Positive DC Grid No. 1 Voltage	0	0 Volt
Plate Dissipation (Max.)	3.1	2.25 Watts
Screen Dissipation (Max.)	0.65	— Watts
Grid Circuit Resistance		
Cathode Bias (Max.)	1.0	0.68 Megohm

**CHARACTERISTICS AND TYPICAL OPERATION**

	<b>Pentode Section</b>	<b>Each Triode Section</b>
Plate Voltage	125	125 Volts
Screen Voltage	125	— Volts
Cathode Bias Resistor	56	120 Ohms

Amplification Factor .....	—	58
Plate Resistance (Approx.) .....	200,000	7250 Ohms
Transconductance .....	13,000	8000 $\mu$ mhos
Plate Current .....	11	8.0 Ma
Screen Current .....	3.4	— Ma
Grid No. 1 Voltage (Approx.) $I_b = 20 \mu a$ .....	-3.5	— Volts
Grid No. 1 Voltage (Approx.) $I_b = 50 \mu a$ .....	—	-4.5 Volts

Color Television Type

**BURST AMPLIFIER (P)  
VIDEO AMPLIFIER (T)**

**6MB8**

5MB8

**Medium Mu Triode and Sharp Cutoff Pentode**

Construction ..... Miniature T-6½  
 Base ..... Button 9 Pin, E9-1  
 Basing ..... 9FA  
 Outline ..... 6-2  
 Maximum Diameter ..... 0.875 In.  
 Maximum Seated Height ..... 1.938 In.  
 Maximum Overall Height ..... 2.185 In.

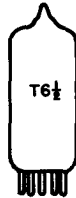
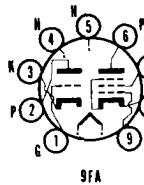

**ELECTRICAL DATA  
HEATER OPERATION**

	<b>5MB8</b>	<b>6MB8</b>
Heater Voltage .....	4.5	6.3 Volts
Heater Current .....	450	400 Ma
Heater Warm-up Time .....	11	— Seconds
Maximum Heater-Cathode Voltage		
Heater Negative with Respect to Cathode		
Total DC and Peak .....		200 Volts
Heater Positive with Respect to Cathode		
DC .....		100 Volts
Total DC and Peak .....		200 Volts

**DIRECT INTERELECTRODE CAPACITANCES (Shielded)**

**Triode Section**

Grid to Plate .....	1.4 Pf
Input: $g_1$ to (Tk + Pk + Pg3 + IS + h) .....	2.2 Pf
Output: p to (Tk + Pk + Pg3 + IS + h) .....	1.9 Pf

**Pentode Section**

Grid No. 1 to Plate (Max.) .....	0.015 Pf
Input: $g_1$ to (k + g3 + IS + g2 + h) .....	5.5 Pf
Output: p to (k + g3 + IS + g2 + h) .....	3.4 Pf

**RATINGS (Design Maximum Rating System)**

	<b>Triode Section</b>	<b>Pentode Section</b>
Plate Voltage (Max.) .....	280	280 Volts
Grid No. 2 Supply Voltage (Max.) .....	—	280 Volts
Grid No. 2 Pulse Voltage (Max.) <sup>(1)</sup> .....	—	300 Volts
Grid No. 2 Voltage .....	See Rating Chart (Gen. Info. Sec.)	
Cathode Current (Max.) .....	20	20 Ma
Plate Dissipation (Max.) .....	2.0	2.0 Watts
Grid No. 2 Dissipation (Max.) .....	—	0.5 Watt
Positive Grid No. 1 Voltage (Max.) .....	0	0 Volt
Maximum Grid No. 1 Circuit Resistance		
Self Bias (Max.) .....	0.5	0.25 Megohm
Fixed Bias (Max.) .....	1.0	0.5 Megohm

Control grid to cathode spacing of the pentode section of this type is of such low order of magnitude as to preclude the use of voltage between these elements of more than 30 volts DC and peak AC in commercial tube checkers and shorts indicating devices, particularly where mechanical excitation of the tube is employed.

**CHARACTERISTICS AND TYPICAL OPERATION**

**Class A1 Amplifier**

	<b>Triode Section</b>	<b>Pentode Section</b>
Plate Voltage .....	125	125 Volts
Grid No. 2 Voltage .....	—	125 Volts
Grid No. 1 Voltage .....	0	0 Volt
Cathode Bias Resistor .....	68	33 Ohms
Plate Current .....	13	10 Ma
Grid No. 2 Current .....	—	2.8 Ma

Transconductance .....	8000	12,000 $\mu$ mhos
Amplification Factor .....	40	—
Plate Resistance (Approx.) .....	5000	125,000 Ohms
$E_{c1}$ for $I_b = 100 \mu a$ .....	-5	— Volts
$E_{c1}$ for $I_b = 50 \mu a$ .....	—	-3 Volts

**NOTE:**

(1) Rating determined at television horizontal deflection sweep frequency of 15,750 Hertz.

**6MD8**  
12MD8

Color Television Type  
**CHROMA MATRIXING AMPLIFIER**

**Triple Triode**

Construction .....Novar T-9  
 Base ..... Button 9 Pin, E9-75 or E9-89  
 Basing .....9RQ  
 Outline  
 Maximum Diameter .....1.188 In.  
 Maximum Seated Height .....2.580 In.  
 Maximum Overall Height .....2.960 In.

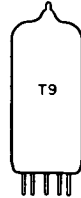
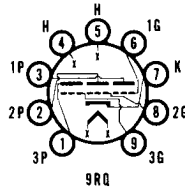

**ELECTRICAL DATA  
HEATER OPERATION**

	<b>12MD8</b>	<b>6MD8</b>
Heater Voltage .....	12.5	6.3 Volts
Heater Current .....	450	900 Ma
Heater Warm-up Time .....	11	— Seconds
Maximum Heater-Cathode Voltage		
Heater Negative with Respect to Cathode		
Total DC and Peak .....		200 Volts
Heater Positive with Respect to Cathode		
DC .....		100 Volts
Total DC and Peak .....		200 Volts

**DIRECT INTERELECTRODE CAPACITANCES (Unshielded)**

	Section 1	Section 2	Section 3
Grid to Plate .....	3.0	3.0	3.0 Pf
Input (G to K and H) .....	3.6	3.6	3.4 Pf
Output (P to K and H) .....	0.48	0.48	0.36 Pf

**AVERAGE PLATE CHARACTERISTICS**

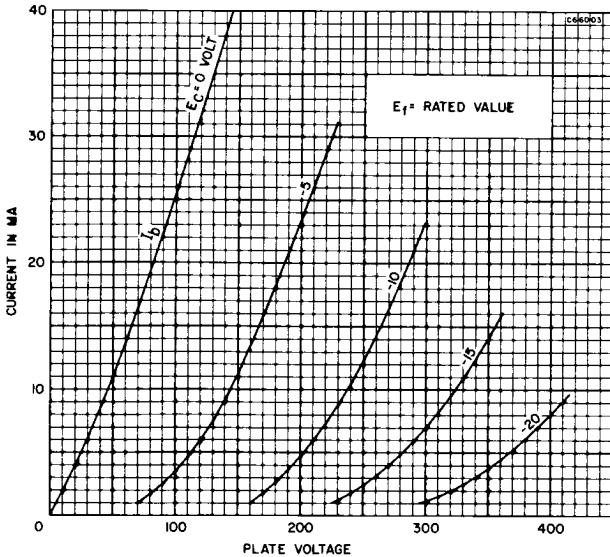



**RATINGS (Design Maximum Rating System) (Each Section)**

Plate Voltage .....	330 Volts
Grid Voltage (Positive Bias Value) .....	0 Volt
Plate Dissipation .....	3 Watts
Grid Circuit Resistance (Fixed Bias) .....	1 Megohm

**CHARACTERISTICS AND TYPICAL OPERATION**

**Class A1 Amplifier (Each Section)**

Plate Voltage .....	250 Volts
Grid Voltage .....	-10.5 Volts
Plate Current .....	11.5 Ma
Amplification Factor .....	17
Plate Resistance (Approx.) .....	5500 Ohms
Transconductance .....	3100 $\mu$ mhos
Ib for Ec1 = -14 Volts .....	4 Ma
Ec1 for Ib = 50 $\mu$ a .....	-23 Volts

Color Television Type

**SYNCHRONOUS DETECTOR**

**6ME8**

**Sheet Beam Tube (Double Plate)**

Construction .....	Miniature T-6½
Base .....	Button 9 Pin, E9-1
Basing <sup>(1)</sup> .....	9RU
Outline .....	6-3
Maximum Diameter .....	0.875 In.
Maximum Seated Height .....	2.375 In.
Maximum Overall Height .....	2.625 In.

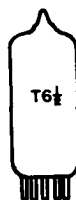
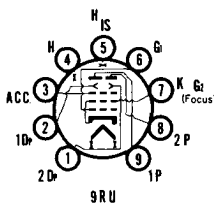

**ELECTRICAL DATA**

**HEATER OPERATION**

Heater Voltage .....	6.3 Volts
Heater Current .....	300 Ma

**DIRECT INTERELECTRODE CAPACITANCES (Unshielded)**

Deflector No. 1 to All .....	6.0 Pf
Deflector No. 2 to All .....	6.0 Pf
Grid No. 1 to All Except Plates .....	7.5 Pf
Plate No. 1 to All .....	6.0 Pf
Plate No. 2 to All .....	6.0 Pf
Grid No. 1 to Deflector No. 1 (Max.) .....	0.07 Pf
Grid No. 1 to Deflector No. 2 (Max.) .....	0.1 Pf
Plate No. 1 to Plate No. 2 .....	0.4 Pf
Deflector No. 1 to Deflector No. 2 .....	0.4 Pf

**RATINGS (Design Maximum Rating System)**

Plate Voltage (Max.) .....	400 Volts
Accelerator Voltage (Max.) .....	400 Volts
Deflector Voltage (Max.) .....	100 Volts
Peak Deflector Voltage .....	
Positive (Max.) .....	200 Volts
Negative (Max.) .....	200 Volts
Positive DC Grid No. 1 Voltage (Max.) .....	0 Volt
Plate Dissipation, Each Plate (Max.) .....	2.0 Watts
Accelerator Dissipation (Max.) .....	2.0 Watts
DC Cathode Current (Max.) .....	30 Ma
Grid No. 1 Circuit Resistance .....	
Fixed Bias (Max.) .....	0.1 Megohm
Cathode Bias (Max.) .....	0.25 Megohm

**CHARACTERISTICS AND TYPICAL OPERATION<sup>(3)</sup>**

Plate Voltage (Plates 1 and 2 Connected Together) .....	250 Volts
Accelerator Voltage .....	350 Volts
Deflector No. 1 Voltage .....	75 Volts
Deflector No. 2 Voltage .....	75 Volts
Cathode Bias Resistor .....	390 Ohms
Total Plate Current .....	14.5 Ma
Accelerator Current .....	0.7 Ma
Grid No. 1 Transconductance .....	4400 $\mu$ mhos
Grid No. 1 Voltage (Approx.) .....	
Ib (total) = 10 $\mu$ a .....	-16 Volts
Deflector Switching Voltage (Max.) <sup>(2)</sup> .....	30 Volts
Voltage Difference between Deflectors for Ib1 = Ib2 (Approx.) .....	0 Volt
Plate No. 1 Current (Max.) Ed1 = 55 V, Ed2 = 95 V .....	1.3 Ma
Plate No. 2 Current, (Max.) Ed1 = 95 V, Ed2 = 55 V .....	1.3 Ma

Deflector No. 1 Current (Max.)  $E_{d1} = 125$  V,  $E_{d2} = 25$  V ..... 0.04 Ma  
 Deflector No. 2 Current (Max.)  $E_{d1} = 25$  V,  $E_{d2} = 125$  V ..... 0.04 Ma

**NOTES:**

- (1) Pin 5 should be connected directly to ground.
- (2) Deflector switching voltage is defined as the total voltage change from +75 Volts on either deflector with an equal and opposite change on the other deflector required to switch the plate current from one plate to the other.
- (3) The 6ME8 should be so located in the equipment that it is not subjected to stray magnetic fields.

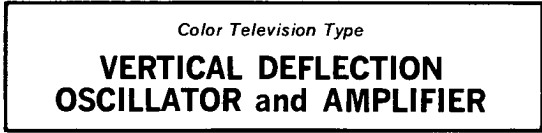

**High Mu Triode and Beam Power Pentode**

Construction..... Compactron T-12  
 Base ..... Button 12 Pin, E12-74  
 Basing ..... 12DZ  
 Outline ..... 12-57  
 Maximum Diameter ..... 1.562 In.  
 Maximum Seated Height ..... 2.750 In.  
 Maximum Overall Height ..... 3.125 In.

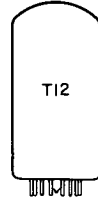
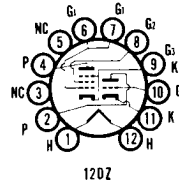

**ELECTRICAL DATA HEATER OPERATION**

	<b>15FM8</b>	<b>6MF8</b>
Heater Voltage .....	14.7	6.3 Volts
Heater Current .....	600	1400 Ma
Heater Warm-up Time .....	11	— Seconds
Maximum Heater-Cathode Voltage		
Heater Negative with Respect to Cathode		
Total DC and Peak .....		200 Volts
Heater Positive with Respect to Cathode		
DC .....		100 Volts
Total DC and Peak .....		200 Volts

**DIRECT INTERELECTRODE CAPACITANCES (Unshielded)**

**Triode Section**

Grid to Plate .....	6.0 Pf
Input .....	6.5 Pf
Output .....	1.6 Pf

**Pentode Section**

Grid No. 1 to Plate (Max.) .....	0.54 Pf
Input .....	9.5 Pf
Output .....	7.0 Pf

**Coupling**

Pentode Grid No. 1 to Triode Plate (Max.) .....	0.12 Pf
Pentode Plate to Triode Plate (Max.) .....	0.32 Pf

**RATINGS (Design Maximum Rating System)**

**Vertical Deflection Oscillator and Amplifier<sup>(1)</sup>**

	<b>Tri. Osc.</b>	<b>Pent. Amp.</b>
Plate Voltage (Max.) .....	400	400 Volts
Grid No. 2 Voltage (Max.) .....	—	300 Volts
Peak Positive Pulse Plate Voltage (Max.) .....	—	2500 Volts
Peak Negative Grid No. 1 Voltage (Max.) .....	400	— Volts
Plate Dissipation (Max.) <sup>(2)</sup> .....	2.5	12 Watts
Grid No. 2 Dissipation (Max.) <sup>(2)</sup> .....	—	2.75 Watts
Average Cathode Current (Max.) .....	30	75 Ma
Peak Cathode Current (Max.) .....	105	260 Ma
Peak Power Output (Max.) .....	2.5	— Watts
Grid Circuit Resistance		
Self Bias (Max.) .....	2.2	2.2 Megohms
Fixed Bias (Max.) .....	—	1.0 Megohm
Bulb Temperature (Max.) .....	—	200 °C

**CHARACTERISTICS AND TYPICAL OPERATION**

	<b>Triode Section</b>	<b>Pentode Section</b>
Plate Voltage .....	250	250 Volts
Grid No. 2 Voltage .....	—	250 Volts
Grid No. 1 Voltage .....	-4	-20 Volts
Plate Current .....	2.6	50 Ma
Grid No. 2 Current .....	—	3.5 Ma

Transconductance .....	4100	4100 $\mu$ mhos
Amplification Factor .....	58	—
Plate Resistance (Approx.) .....	14,000	5000 Ohms
Ec for Ib = 10 $\mu$ a .....	-6.6	— Volts
Ec for Ib = 100 $\mu$ a .....	—	-65 Volts

**INSTANTANEOUS PLATE KNEE VALUES**

Eb = 60 V; Ec2 = 250 V; and Ec = 0 V  
Ib = 200 Ma, and Ic2 = 20 Ma

**NOTES:**

- (1) For operation in a 525 line, 30 frame system as described in "Standards of Good Engineering Practice for Television Broadcast Stations; Federal Communications Commission," the duty cycle of the voltage pulse must not exceed 15% of one horizontal scanning cycle.
- (2) In stages operating with grid leak bias, an adequate bias resistor or other suitable means is required to protect the tube in the absence of excitation.

**HORIZONTAL DEFLECTION OSC.  
SYNC SEP. or AGC AMPLIFIER**

**6MG8**

**Medium Mu Triode and  
Sharp Cutoff Pentode**

Construction ..... Miniature T-6½  
Base ..... Button 9 Pin, E9-1  
Basing ..... 9DC  
Outline ..... 6-2  
Maximum Diameter ..... 0.875 In.  
Maximum Seated Height ..... 1.937 In.  
Maximum Overall Height ..... 2.187 In.

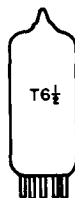
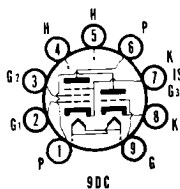

**ELECTRICAL DATA**

**HEATER OPERATION**

Heater Voltage.....	6.3 Volts
Heater Current .....	450 Ma
Maximum Heater-Cathode Voltage	
Heater Negative with Respect to Cathode	
Total DC and Peak.....	200 Volts
Heater Positive with Respect to Cathode	
DC .....	100 Volts
Total DC and Peak.....	200 Volts

**DIRECT INTERELECTRODE CAPACITANCES (Shielded)**

**Triode Section**

Grid to Plate .....	1.5 Pf
Input: Tg1 to (Tk, H, Pk, Pg3 and IS) .....	2.9 Pf
Output: Tp to (Tk, H, Pk, Pg3 and IS) .....	1.6 Pf

**Pentode Section**

Grid No. 1 to Plate (Max.).....	0.025 Pf
Input: Pg1 to (Pk, H, Pg2, Pg3 and IS).....	5.5 Pf
Output: Pp to (Pk, H, Pg2, Pg3 and IS).....	3.8 Pf

**RATINGS (Design Maximum Rating System)**

	<b>Triode Section</b>	<b>Pentode Section</b>
Plate Voltage (Max.) .....	330	330 Volts
Plate Dissipation (Max.) .....	2.5	2.0 Watts
Grid No. 2 Supply Voltage (Max.) .....	—	300 Volts
Grid No. 2 Dissipation		
At Plate Dissipation More Than 1.2 Watts (Max.) .....	—	0.5 Watts
At Plate Dissipation Less Than 1.2 Watts (Max.) .....	—	0.75 Watts
Cathode Current (Max.) .....	14	14 Ma
Grid No. 1 Circuit Resistance		
Fixed Bias (Max.) .....	0.5	0.5 Megohm
Cathode Bias (Max.) .....	0.5	1.0 Megohm

**CHARACTERISTICS AND TYPICAL OPERATION**

	<b>Triode Section</b>	<b>Pentode Section</b>
Plate Voltage .....	150	170 Volts
Grid No. 2 Voltage .....	—	170 Volts
Grid No. 1 Voltage .....	—	-2.0 Volts
Cathode Bias Resistor .....	56	— Ohms
Plate Current .....	18.0	10 Ma
Grid No. 2 Current .....	—	2.8 Ma
Transconductance .....	8500	6200 $\mu$ mhos
Plate Resistance (Approx.) .....	5.0	400 K Ohms
Amplification Factor .....	40	47 (G2-G1)
Grid No. 1 Voltage (Ib = 10 $\mu$ a) .....	-12	— Volts

# 6MJ8

## Color Television Type CHROMA MATRIXING AMPLIFIER

### Triple Triode

Construction..... Compactron T-9  
 Base ..... Button 12 Pin, E12-70  
 Basing ..... 12HG  
 Outline ..... 9-60  
 Maximum Diameter ..... 1.188 In.  
 Maximum Seated Height ..... 2.500 In.  
 Maximum Overall Height ..... 2.875 In.

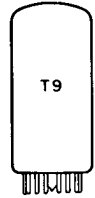
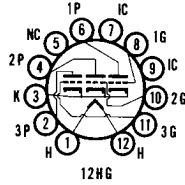

### ELECTRICAL DATA HEATER OPERATION

Heater Voltage..... 6.3 Volts  
 Heater Current..... 900 Ma  
 Maximum Heater-Cathode Voltage  
 Heater Negative with Respect to Cathode  
 Total DC and Peak..... 200 Volts  
 Heater Positive with Respect to Cathode  
 DC ..... 100 Volts  
 Total DC and Peak..... 200 Volts

### DIRECT INTERELECTRODE CAPACITANCES (Unshielded)

	Sec. 1	Sec. 2	Sec. 3
Grid to Plate .....	3.0	3.0	3.0 Pf
Input (g to k and H) .....	3.6	3.6	3.4 Pf
Output (P to k and H) .....	0.48	0.48	0.36 Pf

### RATINGS (Design Maximum Rating System) (Each Section)

Plate Voltage (Max.) ..... 330 Volts  
 Grid Voltage Positive Bias Value (Max.) ..... 0 Volt  
 Plate Dissipation (Max.) ..... 3 Watts  
 Grid Circuit Resistance  
 Fixed Bias (Max.) ..... 1 Megohm

### CHARACTERISTICS AND TYPICAL OPERATION

#### Class A1 Amplifier (Each Section)

Plate Voltage ..... 250 Volts  
 Grid Voltage ..... -10.5 Volts  
 Plate Current ..... 11.5 Ma  
 Amplification Factor ..... 17  
 Plate Resistance (Approx.) ..... 5500 Ohms  
 Transconductance ..... 3100  $\mu$ mhos  
 Ib for Ec1 = -14 Volts ..... 4 Ma  
 Ec1 for Ib = 50  $\mu$ a ..... -23 Volts

# 6MK8

4MK8

## SYNC SEP., CLIPPER, AGC AMP. LOW LEVEL COLOR DEMODULATOR

### Double Pentode

Construction ..... Miniature T-6½  
 Base ..... Button 9 Pin, E9-1  
 Basing ..... 9FG  
 Outline ..... 6-3  
 Maximum Diameter ..... 0.875 In.  
 Maximum Seated Height ..... 2.375 In.  
 Maximum Overall Height ..... 2.625 In.

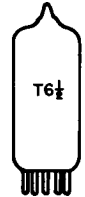
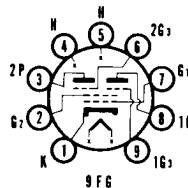

### ELECTRICAL DATA HEATER OPERATION

	4MK8	6MK8
Heater Voltage.....	4.2	6.3 Volts
Heater Current.....	450	300 Ma
Heater Warm-up Time.....	11	— Seconds
Maximum Heater-Cathode Voltage Heater Negative with Respect to Cathode Total DC and Peak.....		200 Volts
Heater Positive with Respect to Cathode DC .....		100 Volts
Total DC and Peak.....		200 Volts

**DIRECT INTERELECTRODE CAPACITANCES (Unshielded)**

Grid No. 3 to Plate (Each Section) .....	2.0 Pf
Grid No. 1 to All .....	6.0 Pf
Grid No. 3 (Each Section) to All .....	3.6 Pf
Plate (Each Section) to All .....	3.0 Pf
Grid No. 3 (Section 1) to Grid No. 3 (Section 2) (Max.) .....	0.015 Pf

**RATINGS (Design Maximum Rating System)**

Plate Voltage (Each Section) (Max.) .....	300 Volts
Grid No. 2 Voltage (Max.) .....	150 Volts
Positive DC Grid No. 3 Voltage (Each Section) (Max.) .....	3.0 Volts
Negative DC Grid No. 3 Voltage (Each Section) (Max.) .....	50 Volts
Peak Positive Grid No. 3 Voltage (Each Section) (Max.) .....	50 Volts
Negative DC Grid No. 1 Voltage (Max.) .....	50 Volts
Plate Dissipation (Each Section) (Max.) .....	1.1 Watts
Grid No. 2 Dissipation (Max.) .....	0.75 Watt
DC Cathode Current (Max.) .....	12 Ma
Grid No. 1 Circuit Resistance (Max.) .....	0.5 Megohm
Grid No. 3 Circuit Resistance (Each Section) (Max.) .....	0.5 Megohm

**CHARACTERISTICS AND TYPICAL OPERATION**

**Both Sections Operating**

Plate Voltage (Each Section) .....	100	100 Volts
Grid No. 2 Voltage .....	67.5	67.5 Volts
Grid No. 3 Voltage (Each Section) .....	-10	0 Volt
Grid No. 1 Voltage .....	Note 1	Note 1
Plate Current (Each Section) .....	—	2.0 Ma
Grid No. 2 Current .....	7.0	4.4 Ma
Cathode Current .....	7.1	8.5 Ma

**MAXIMUM PLATE CURRENT RATIO (Balance)**

$E_b = 100$  V,  $E_{c2} = E_{c1} = 67.5$  V,  $E_{c3} = 0$ ,  $R_{g1} = 0.68$  Megohms 1.3 to 1

**Each Section Operating Separately with Plate and Grid No. 3 of Opposite Section Grounded**

Plate Voltage .....	100	100 Volts
Grid No. 2 Voltage .....	67.5	67.5 Volts
Grid No. 3 Voltage .....	0	0 Volt
Grid No. 1 Voltage .....	0	Note 1
Plate Current .....	—	2.0 Ma
Grid No. 3 Transconductance .....	—	450 $\mu$ mhos
Grid No. 1 Transconductance .....	1100	— $\mu$ mhos
$E_{c3}$ for $I_b = 100 \mu$ a (Approx.) .....	—	-3.5 Volts
$E_{c1}$ for $I_b = 100 \mu$ a (Approx.) .....	—	-2.3 Volts

**NOTE:**

(1) Grid current adjusted for 100  $\mu$ a dc.

**BURST AMPLIFIER and GENERAL PURPOSE AMPLIFIER**

**6MU8**

8MU8

**Medium Mu Triode and Semi-Remote Cutoff Pentode**

Construction .....	Miniature T-6½
Base .....	E9-1
Basing .....	.9AE
Outline .....	6-3
Maximum Diameter .....	0.875 In.
Maximum Seated Height .....	2.375 In.
Maximum Overall Height .....	2.625 In.

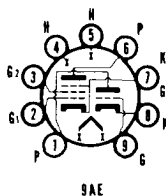

**ELECTRICAL DATA**

**HEATER OPERATION**

	6MU8	6MU8	8MU8
Heater Voltage .....	6.3	6.3	8.4 Volts
Heater Current .....	600	600	450 Ma
Heater Warm-up Time .....	—	11	11 Seconds
Maximum Heater-Cathode Voltage			
Heater Negative with Respect to Cathode			
Total DC and Peak .....			200 Volts
Heater Positive with Respect to Cathode			
DC .....			100 Volts
Total DC and Peak .....			200 Volts

**DIRECT INTERELECTRODE CAPACITANCES**

	With Shield	Without Shield
<b>Triode Section</b>		
Grid to Plate .....	2.2	2.2 pf
Input: g1 to (Tk + Pk + Pg3 + IS + h) .....	3.2	3.0 pf
Output: p to (Tk + Pk + Pg3 + IS + h) .....	3.4	2.2 pf
<b>Pentode Section</b>		
Grid No. 1 to Plate (Max.) .....	0.05	0.05 pf
Input: g1 to (k + g3 + IS + g2 + h).....	9.0	9.0 pf
Output: p to (k + g3 + IS + g2 + h).....	4.4	3.6 pf
Heater to Cathode (Triode Section) .....	4.8	4.4 pf
Heater to Cathode (Pentode Section) .....	7.5	5.5 pf
Pentode Grid No. 1 to Triode Plate (Pg1 to Tp) (Max.) .....	0.20	0.170 pf
Pentode Plate to Triode Plate (Pp to Tp) (Max.) .....	0.008	0.090 pf

**RATINGS (Design Maximum Rating System)  
Class A1 Amplifier**

	Triode Section	Pentode Section
Plate Voltage (Max.) .....	330	330 Volts
Grid No. 2 (Screen-Grid) Supply Voltage (Max.) .....	—	330 Volts
Grid No. 2 Voltage .....	See Rating Chart (Gen. Info. Sec.)	
Grid No. 1 (Control-Grid) Voltage: Positive Bias (Max.) .....	0	0 Volt
Grid No. 2 Dissipation (Max.) .....	—	1.1 Watts
Plate Dissipation (Max.) .....	2.5	3.75 Watts
Maximum Grid No. 1 Circuit Resistance		
Fixed-Bias .....	0.5	0.25 Megohm
Cathode-Bias .....	1.0	1.0 Megohm

Control grid to cathode spacing of the pentode section of this type is of such low order of magnitude as to preclude the use of voltage between these elements of more than 30 volts dc or peak ac in commercial tube checkers and shorts indicating devices, particularly where mechanical excitation of the tube is employed.

**CHARACTERISTICS AND TYPICAL OPERATION  
Class A1 Amplifier**

	Triode Section	Pentode Section
Plate Voltage .....	125	150 Volts
Grid No. 2 Voltage .....	—	150 Volts
Grid No. 1 Voltage .....	-1	— Volts
Cathode Bias Resistor .....	—	150 Ohms
Plate Current .....	11.5	19 Ma
Grid No. 2 Current .....	—	4.2 Ma
Transconductance .....	6000	9000 $\mu$ mhos
Amplification Factor .....	35	—
Plate Resistance (Approx.) .....	5800	165,000 Ohms
Ec1 for Ib = 10 $\mu$ a (Approx.) .....	-5.8	— Volts
Ec1 for Ib = 20 $\mu$ a (Approx.) .....	—	-9.5 Volts

**6S4A**

Color Television Type

**VERTICAL DEFLECTION  
AMPLIFIER**

**Medium Mu Triode**

Construction ..... Miniature T-6 $\frac{1}{2}$   
 Base ..... Button 9 Pin, E9-1  
 Basing ..... 9AC  
 Outline ..... 6-3  
 Maximum Diameter ..... 0.875 In.  
 Maximum Seated Height ..... 2.375 In.  
 Maximum Overall Height ..... 2.625 In.

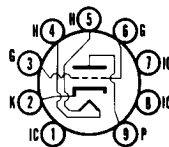

9 AC

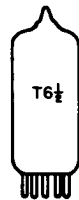

**ELECTRICAL DATA  
HEATER OPERATION**

Heater Voltage .....	6.3 Volts
Heater Current .....	600 Ma
Heater Warm-up Time .....	11 Seconds

Maximum Heater-Cathode Voltage	
Heater Negative with Respect to Cathode	
Total DC and Peak.....	200 Volts
Heater Positive with Respect to Cathode	
DC .....	100 Volts
Total DC and Peak.....	200 Volts

**DIRECT INTERELECTRODE CAPACITANCES (Unshielded)**

Grid to Plate .....	2.6 Pf
Input: g1 to (h + k) .....	4.2 Pf
Output: p to (h + k) .....	0.9 Pf

**RATINGS (Design Center Rating System)**

**Vertical Deflection Amplifier<sup>(1)</sup>**

Plate Voltage (Max.) .....	500 Volts
Peak Positive Plate Voltage (Abs. Max.) .....	2200 Volts
Plate Dissipation (Max.) <sup>(2)</sup> .....	7.5 Watts
Peak Negative Grid Voltage (Max.) .....	250 Volts
Average Cathode Current (Max.).....	30 Ma
Peak Cathode Current (Max.) .....	105 Ma
Grid Circuit Resistance	
Cathode Bias (Max.) .....	2.2 Megohms

**CHARACTERISTICS AND TYPICAL OPERATION**

Plate Voltage .....	250 Volts
Grid Voltage .....	-8 Volts
Plate Current .....	26 Ma
Transconductance .....	4500 $\mu$ mhos
Amplification Factor .....	16
Plate Resistance .....	3600 Ohms
Plate Current at $E_c = -15$ V .....	4.5 Ma
Grid Voltage for $I_b = 50 \mu$ a .....	-23 Volts

**Vertical Deflection Amplifier**

**70° Picture Tube—15 Kv 2nd Anode Voltage**

Plate Supply Voltage.....	435 Volts
Plate Output Voltage	
Peak to Peak .....	900 Volts
Sawtooth Component .....	320 Volts
Grid Input Voltage	
Peak to Peak .....	60 Volts
Sawtooth Component .....	40 Volts
Average Cathode Current .....	16 Ma
Peak Cathode Current .....	40 Ma
Cathode Resistor .....	1200 Ohms

**NOTES:**

- (1) For operation in a 525 line, 30 frame system as described in "Standards of Good Engineering Practice for Television Broadcast Stations; Federal Communications Commission," the duty cycle of the voltage pulse must not exceed 15% of one horizontal scanning cycle.
- (2) In stages operating with grid leak bias, an adequate cathode bias resistor or other suitable means is required to protect the tube in the absence of excitation.

**AM CONVERTER**

**6SA7GT**  
12SA7GT

**Heptode**

Construction .....	Octal T-9
Base.....	Octal 8 Pin, B8-6 or B8-58
Basing .....	8AD
Outline .....	9-11 or 9-41
Maximum Diameter .....	1.188 In.
Maximum Seated Height .....	2.750 In.
Maximum Overall Height .....	3.312 In.

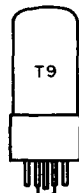
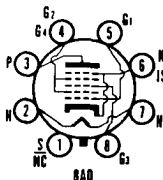

**ELECTRICAL DATA**  
**HEATER OPERATION**

	<b>12SA7GT</b>	<b>6SA7GT</b>
Heater Voltage.....	12.6	6.3 Volts
Heater Current .....	150	300 Ma
Maximum Heater-Cathode Voltage .....	90	90 Volts

**DIRECT INTERELECTRODE CAPACITANCES**

	Shielded	Unshielded
Mixer Grid No. 3 to Plate (Max.)	0.5	0.7 Pf
RF Input: g3 to (h + k + g1 + g2 + g4 + g5 + p)	9.5	9.5 Pf
Mixer Output: p to (h + k + g1 + g2 + g4 + g3 + g5)	9.5	6.5 Pf
Oscillator Grid to Cathode and Grid No. 5	3.5	3.0 Pf
Oscillator Input: g1 to (h + k + g2 + g4 + g3 + g5 + p)	8.0	8.0 Pf
Oscillator Output: k + g5 to (h + g2 + g4 + g3 + p)	20	14 Pf

**Coupling**

Oscillator Grid to Plate (Max.)	0.4	0.5 Pf
Mixer Grid No. 3 to Oscillator Grid	0.4	0.4 Pf
Oscillator Grid to All Except Cathode and Grid No. 5	5.0	5.0 Pf

**RATINGS (Design Center Rating System)**

Plate Voltage (Max.)		300 Volts
Grid No. 2 and Grid No. 4 Supply Voltage (Max.)		300 Volts
Grid No. 2 and Grid No. 4 Voltage (Max.)		100 Volts
Negative Grid No. 3 Voltage (Max.)		50 Volts
Positive Grid No. 3 Voltage (Max.)		0 Volt
Plate Dissipation (Max.)		1.0 Watt
Grid No. 2 and Grid No. 4 Dissipation (Max.)		1.0 Watt
Cathode Current (Max.)		14 Ma

**CHARACTERISTICS AND TYPICAL OPERATION**

Plate Voltage	100	250 Volts
Grid No. 2 and Grid No. 4 Voltage	100	100 Volts
Grid No. 3 Voltage	-2	-2 Volts
Oscillator Grid No. 1 Voltage (RMS)	10	10 Volts
Oscillator Grid No. 1 Resistance	20,000	20,000 Ohms
Oscillator Grid Current	0.5	0.5 Ma
Plate Current	3.3	3.5 Ma
Grid No. 2 and Grid No. 4 Current	8.5	8.5 Ma
Conversion Transconductance	425	450 μmhos
Plate Resistance (Approx.)	0.5	1.0 Megohm
Cathode Current	12.3	12.5 Ma
Ec3 for Gm = 10 μmhos (Approx.)	-25	-25 Volts
Ec3 for Gm = 100 μmhos (Approx.)	-9	-9 Volts

**OSCILLATOR CHARACTERISTICS (Non-Oscillating)**

Grid No. 2 and Grid No. 4 Voltage <sup>(1)</sup>		100 Volts
Grid No. 3 Voltage		0 Volt
Grid No. 1 Voltage		0 Volt
Transconductance between Grid No. 1 to Grid No. 2 and Grid No. 4 <sup>(1)</sup>		4500 μmhos
Amplification Factor between Grid No. 1 and Grid No. 2 and Grid No. 4 <sup>(1)</sup>		14
Cathode Current		25 Ma
Ec1 for Ib = 10 μa (Approx.)		-14 Volts

**NOTE:**

(1) Connected to plate.

**6SJ7GT**

**12SJ7GT**

**RF or AF AMPLIFIER**

**Sharp Cutoff Pentode**

Construction	Octal T-9
Base	Octal 8 Pin, B8-26
Basing	8N
Outline	9-12
Maximum Diameter	1.188 In.
Maximum Seated Height	2.750 In.
Maximum Overall Height	3.312 In.

**ELECTRICAL DATA  
HEATER OPERATION**

	12SJ7GT	6SJ7GT
Heater Voltage	12.6	6.3 Volts
Heater Current	150	300 Ma
Maximum Heater-Cathode Voltage	90	90 Volts

**DIRECT INTERELECTRODE CAPACITANCES (Unshielded)**

Grid No. 1 to Plate (Max.)		0.005 Pf
Input: g1 to (h + k + g2 + g3)		7.0 Pf
Output: p to (h + k + g2 + g3)		7.0 Pf

**RATINGS (Design Center Rating System)**

Plate Voltage		300 Volts
Grid No. 3 Voltage		Connected to Cathode at Socket
Grid No. 2 Supply Voltage (Max.)		300 Volts

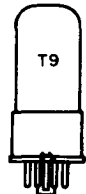
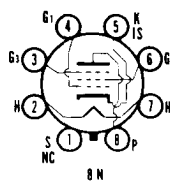



Grid No. 2 Voltage .....	See Rating Chart (Gen. Info. Sec.)
Plate Dissipation (Max.) .....	2.5 Watts
Grid No. 2 Dissipation (Max.) .....	0.7 Watts
Positive Grid No. 1 Voltage (Max.) .....	0 Volt
Grid Circuit Resistance (Self Bias) (Max.) .....	1.0 Megohm

**CHARACTERISTICS AND TYPICAL OPERATION**

Plate Voltage .....	100	250 Volts
Grid No. 3 Voltage .....	Connected to Cathode at Socket	
Grid No. 2 Voltage .....	100	100 Volts
Grid No. 1 Voltage .....	-3	-3 Volts
Plate Current .....	2.9	3 Ma
Grid No. 2 Current .....	0.9	0.8 Ma
Transconductance .....	1575	1650 $\mu$ mhos
Plate Resistance (Approx.) .....	0.7	1.0 Megohm
E <sub>c1</sub> for I <sub>b</sub> = 10 $\mu$ a (Approx.) .....	-8	-8 Volts

**RF or IF AMPLIFIER**

**6SK7GT**  
12SK7GT

**Remote Cutoff Pentode**

Construction .....	Octal T-9
Base .....	Octal 8 Pin, B8-6
Basing .....	8N
Outline .....	9-11
Maximum Diameter .....	1.188 In.
Maximum Seated Height .....	2.750 In.
Maximum Overall Height .....	3.312 In.

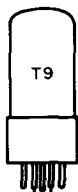
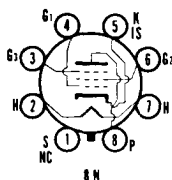

**ELECTRICAL DATA**  
**HEATER OPERATION**

Heater Voltage .....	12.6	6.3 Volts
Heater Current .....	150	300 Ma
Maximum Heater-Cathode Voltage .....	90	90 Volts

**DIRECT INTERELECTRODE CAPACITANCES (Shielded)**

Grid No. 1 to Plate (Max.) .....	0.005 Pf
Input: g <sub>1</sub> to (H + k + g <sub>2</sub> + g <sub>3</sub> ) .....	6.5 Pf
Output: p to (H + k + g <sub>2</sub> + g <sub>3</sub> ) .....	7.5 Pf

**RATINGS (Design Center Rating System)**

Plate Voltage (Max.) .....	300 Volts
Grid No. 2 Supply Voltage (Max.) .....	300 Volts
Grid No. 2 Voltage .....	See Rating Chart (Gen. Info. Sec.)
Positive Grid No. 1 Voltage (Max.) .....	0 Volt
Plate Dissipation (Max.) .....	4.0 Watts
Grid No. 2 Dissipation (Max.) .....	0.4 Watt

**CHARACTERISTICS AND TYPICAL OPERATION**

Plate Voltage .....	100	250 Volts
Grid No. 3 Voltage .....	Connected to Cathode at Socket	
Grid No. 2 Voltage .....	100	100 Volts
Grid No. 1 Voltage .....	-1	-3 Volts
Plate Current .....	13	9.2 Ma
Grid No. 2 Current .....	4.0	2.6 Ma
Transconductance .....	2350	2000 $\mu$ mhos
Plate Resistance (Approx.) .....	120,000	800,000 Ohms
E <sub>c1</sub> for G <sub>m</sub> = 10 $\mu$ mhos (Approx.) .....	-35	-35 Volts

**AF VOLTAGE AMPLIFIER**

**6SL7GT**  
12SL7GT

**High Mu Twin Triode**

Construction .....	Octal T-9
Base .....	Octal 8 Pin, B8-6 or B8-58
Basing .....	8BD
Outline .....	9-11 or 9-41
Maximum Diameter .....	1.188 In.
Maximum Seated Height .....	2.750 In.
Maximum Overall Height .....	3.312 In.

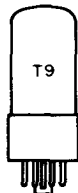
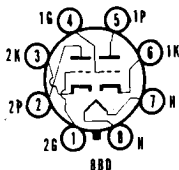

**ELECTRICAL DATA**

**HEATER OPERATION**

Heater Voltage.....	<b>12SL7GT</b>	<b>6SL7GT</b>
Heater Current.....	12.6	6.3 Volts
Maximum Heater-Cathode Voltage.....	150	300 Ma
	90	90 Volts

**DIRECT INTERELECTRODE CAPACITANCES (Shielded)<sup>(1)</sup>**

	<b>Section No. 1<sup>(2)</sup></b>	<b>Section No. 2<sup>(2)</sup></b>
Grid to Plate.....	2.8	2.8 Pf
Grid to Cathode.....	3.0	3.4 Pf
Plate to Cathode.....	3.8	3.2 Pf

**Coupling**

Plate to Plate.....	0.4	Pf
Grid to Grid.....	0.65	Pf
Grid Section No. 2 to Plate Section No. 1.....	0.13	Pf

**RATINGS (Design Center Rating System) (Each Section)**

Plate Voltage (Max.).....	300 Volts
Plate Dissipation (Max.).....	1.0 Watt
Positive Grid Voltage (Max.).....	0 Volt

**CHARACTERISTICS AND TYPICAL OPERATION**

**Class A1 Amplifier (Each Section)**

Plate Voltage.....	250 Volts
Grid Voltage.....	-2 Volts
Cathode Bias Resistor.....	870 Ohms
Plate Current.....	2.3 Ma
Transconductance.....	1600 $\mu$ mhos
Amplification Factor.....	70
Plate Resistance.....	44,000 Ohms

**NOTES:**

- (1) Standard 1 $\frac{1}{4}$ " diameter shield (EIA Std. M8-308) connected to cathode.
- (2) Section No. 1 connects to pins 4, 5, and 6. Section No. 2 connects to pins 1, 2, and 3.

**6SN7GTB**

8SN7GTB, 12SN7GTA

**HORIZONTAL MULTIVIBRATOR,  
PHASE INVERTER, or  
VERTICAL OSC. and AMP.**

**Medium Mu Double Triode**

Construction.....	Octal T-9
Base.....	Octal 8 Pin, B8-6 or B8-58
Basing.....	.8BD
Outline.....	.9-11 or 9-41
Maximum Diameter.....	1.188 In.
Maximum Seated Height.....	2.750 In.
Maximum Overall Height.....	3.312 In.

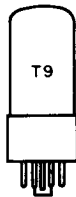
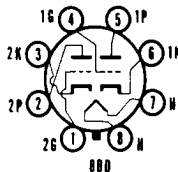

**ELECTRICAL DATA**

**HEATER OPERATION**

Heater Voltage.....	<b>12SN7GTA</b>	<b>8SN7GTB</b>	<b>6SN7GTB</b>
Heater Current.....	12.6	8.4	6.3 Volts
Heater Warm-up Time.....	300	450	600 Ma
Maximum Heater-Cathode Voltage.....	—	11	11 Seconds

Heater Negative with Respect to Cathode

Total DC and Peak..... 200 Volts

Heater Positive with Respect to Cathode

DC..... 100 Volts

Total DC and Peak..... 200 Volts

**DIRECT INTERELECTRODE CAPACITANCES (Unshielded)**

	<b>Section 1<sup>(1)</sup></b>	<b>Section 2<sup>(1)</sup></b>
Grid to Plate.....	4.0	3.8 Pf
Input.....	2.2	2.6 Pf
Output.....	0.7	0.7 Pf

**RATINGS (Design Center Rating System)**

	<b>Class A1 Amplifier</b>	<b>Vertical<sup>(2)</sup> Deflection Amplifier</b>
Plate Voltage (Max.).....	450	450 Volts
Peak Positive Plate Voltage (Abs. Max.).....	—	1500 Volts
Plate Dissipation		
Each Plate (Max.).....	5.0	5.0 Watts
Both Plates (Max.).....	7.5	7.5 Watts

Peak Negative Grid Voltage (Max.) .....	—	250 Volts
Cathode Current (Max.) .....	20	20 Ma
Peak Cathode Current (Max.) .....	—	70 Ma
Grid No. 1 Circuit Resistance		
Fixed Bias (Max.) .....	1.0	— Megohm
Cathode Bias (Max.) .....	1.0	2.2 Megohm
	<b>Vertical<sup>(2)</sup></b>	<b>Horizontal<sup>(2)</sup></b>
	<b>Deflection</b>	<b>Deflection</b>
	<b>Oscillator</b>	<b>Oscillator</b>
Plate Voltage (Max.) .....	450	450 Volts
Plate Dissipation		
Each Plate (Max.) .....	5.0	5.0 Watts
Both Plates (Max.) .....	7.5	7.5 Watts
Peak Negative Grid Voltage (Max.) .....	400	600 Volts
Average Cathode Current (Max.) .....	20	20 Ma
Peak Cathode Current (Max.) .....	70	300 Ma
Grid Circuit Resistance (Max.) .....	2.2	2.2 Megohm

**CHARACTERISTICS AND TYPICAL OPERATION**

**Class A1 Amplifier (Each Section)**

Plate Voltage .....	90	250 Volts
Grid Voltage .....	0	-8.0 Volts
Plate Current .....	10	9.0 Ma
Transconductance .....	3000	2600 $\mu$ mhos
Amplification Factor .....	20	20
Plate Resistance (Approx.) .....	6700	7700 Ohms
Plate Current at $E_c = 12.5$ Volts .....	—	1.3 Ma
Grid Voltage for $I_b = 10 \mu$ a (Approx.) .....	-7.0	-18 Volts

**NOTES:**

- (1) Section No. 1 connects to pins 4, 5 and 6. Section No. 2 connects to pins 1, 2 and 3.
- (2) For operation in a 525 line, 30 frame system as described in "Standards of Good Engineering Practice for Television Broadcast Stations; Federal Communications Commission," the duty cycle of the voltage pulse must not exceed 15% of one horizontal scanning cycle.

**AUDIO DETECTOR  
and AMPLIFIER**

**6SQ7GT  
12SQ7GT**

**Double Diode and High Mu Triode**

Construction .....	Octal T-9
Base .....	Octal 8 Pin, B8-26
Basing .....	.8Q
Outline .....	9-12
Maximum Diameter .....	1.188 In.
Maximum Seated Height .....	2.750 In.
Maximum Overall Height .....	3.312 In.

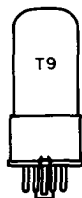
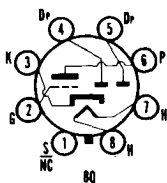

**ELECTRICAL DATA**

**HEATER OPERATION**

	<b>12SQ7GT</b>	<b>6SQ7GT</b>
Heater Voltage .....	12.6	6.3 Volts
Heater Current .....	150	300 Ma
Maximum Heater-Cathode Voltage .....	90	90 Volts

**DIRECT INTERELECTRODE CAPACITANCES (Shielded)**

Diode Plate No. 1 to Heater and Cathode .....	1.8 Pf
Diode Plate No. 2 to Heater and Cathode .....	1.8 Pf
Diode Plate No. 1 to Grid (Max.) .....	0.1 Pf

**RATINGS (Design Center Rating System)**

Plate Voltage (Max.) .....	300 Volts
Plate Dissipation (Max.) .....	0.5 Watts
Positive Grid Voltage (Max.) .....	0 Volt
Diode Current for Continuous Operation (Each Diode) (Max.) .....	1.0 Ma

**CHARACTERISTICS AND TYPICAL OPERATION**

**Class A1 Amplifier**

Plate Voltage .....	100	250 Volts
Grid Voltage .....	-1	-2 Volts
Plate Current .....	0.5	1.1 Ma

Transconductance .....	925	1175 $\mu$ mhos
Amplification Factor .....	100	100
Plate Resistance .....	110,000	85,000 Ohms
Average Diode Current with 10 Volts DC Applied (Each Diode) <sup>(1)</sup> .....	2.0	2.0 Ma

**NOTE:**

(1) Test condition only.



**Low Mu Triode**

Construction ..... Miniature T-5½  
 Base ..... Button 7 Pin, E7-1  
 Basing ..... 7DK  
 Outline ..... 5-1  
 Maximum Diameter ..... 0.750 In.  
 Maximum Seated Height ..... 1.500 In.  
 Maximum Overall Height ..... 1.750 In.

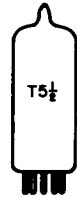
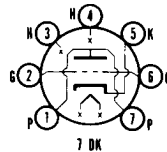

**ELECTRICAL DATA**

**HEATER OPERATION**

Heater Voltage .....	<b>2T4</b> 2.35	<b>6T4</b> 6.3 Volts
Heater Current .....	600	225 Ma
Heater Warm-up Time .....	11	— Seconds
Maximum Heater-Cathode Voltage Heater Negative with Respect to Cathode Total DC and Peak .....		50 Volts
Heater Positive with Respect to Cathode DC .....		25 Volts
Total DC and Peak .....		50 Volts

**DIRECT INTERELECTRODE CAPACITANCES**

	<b>Shielded<sup>(1)</sup></b>	<b>Unshielded</b>
Grid to Plate .....	1.7	1.7 Pf
Input .....	3.3	2.9 Pf
Output .....	1.8	0.25 Pf
Heater to Cathode <sup>(2)</sup> .....	2.9	3.0 Pf
Grid No Cathode <sup>(2)</sup> .....	2.6	2.6 Pf
Plate to Cathode <sup>(2)</sup> .....	0.18	0.20 Pf

**Grounded Grid Operation**

Input .....	5.7	5.5 Pf
Output .....	3.4	1.8 Pf

**RATINGS (Design Center Rating System)**

Plate Voltage (Max.) .....	200 Volts
Plate Dissipation (Max.) .....	3.5 Watts
Grid Current (Max.) .....	8.0 Ma
Cathode Current (Max.) .....	30 Ma

**CHARACTERISTICS AND TYPICAL OPERATION**

Plate Voltage .....	80 Volts
Cathode Resistor .....	150 Ohms
Plate Current .....	18 Ma
Transconductance .....	7000 $\mu$ mhos
Amplification Factor .....	13
Plate Resistance .....	1860 Ohms
Grid Voltage for $I_b = 50 \mu$ a .....	-15 Volts

**Oscillator at 950 MHz**

Plate Voltage .....	80 Volts
Grid Voltage (Self Bias) .....	-4 Volts
Grid Resistor .....	10,000 Ohms
Plate Current .....	18 Ma
Grid Current (Approx.) .....	400 $\mu$ a

**NOTES:**

(1) Shield No. 316.

(2) Measured between specified elements only. When external shield is used, it shall be grounded.

*Color Television Type*  
**CLAMPER or DETECTOR  
 VOLTAGE AMPLIFIER**

**6T8A**  
 5T8, 19T8

**Triple Diode and High Mu Triode**

Construction ..... Miniature T-6½  
 Base ..... Button 9 Pin, E9-1  
 Basing ..... 9E  
 Outline ..... 6-2  
 Maximum Diameter ..... 0.875 In.  
 Maximum Seated Height ..... 1.937 In.  
 Maximum Overall Height ..... 2.187 In.

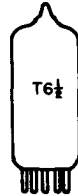
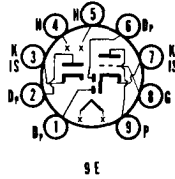

**ELECTRICAL DATA**

**HEATER OPERATION**

	19T8	5T8	6T8A
Heater Voltage.....	18.9	4.7	6.3 Volts
Heater Current.....	150	600	450 Ma
Heater Warm-up Time.....	—	11	11 Seconds
Maximum Heater-Cathode Voltage			
Heater Negative with Respect to Cathode			
Total DC and Peak.....			200 Volts
Heater Positive with Respect to Cathode			
DC.....			100 Volts
Total DC and Peak.....			200 Volts

**DIRECT INTERELECTRODE CAPACITANCES (Unshielded)**

Grid to Plate.....	1.7 Pf
Input.....	1.6 Pf
Output.....	1.2 Pf
Grid to Any Diode Plate (Max.).....	0.034 Pf
Diode No. 1 Input.....	3.8 Pf
Diode No. 2 Input.....	3.8 Pf
Diode No. 3 Input.....	3.4 Pf
Diode No. 2 Cathode to All.....	7.5 Pf

**RATINGS (Design Center Rating System)**

Plate Voltage (Max.).....	300 Volts
Plate Dissipation (Max.).....	1.0 Watt
Positive Grid Voltage (Max.).....	0 Volt
Diode Current for Continuous Operation (Each Plate) (Max.).....	5.0 Ma

**CHARACTERISTICS AND TYPICAL OPERATION**

**Class A Amplifier**

Plate Voltage.....	100	250 Volts
Grid Voltage.....	-1.0	-3.0 Volts
Plate Current.....	0.8	1.0 Ma
Transconductance.....	1300	1200 μmhos
Amplification Factor.....	70	70
Plate Resistance.....	54,000	58,000 Ohms
Average Diode Current with 5 Volt DC Applied (Each Plate) ...	—	20 Ma

*Color Television Type*  
**AUDIO OUTPUT and  
 FM DETECTOR**

**6T10**  
 12T10

**Double Dissimilar Pentode**

Construction..... Compactron T-9  
 Base ..... Button 12 Pin, 12-70  
 Basing ..... 12EZ  
 Outline ..... 9-58  
 Maximum Diameter ..... 1.188 In.  
 Maximum Seated Height ..... 2.000 In.  
 Maximum Overall Height ..... 2.375 In.

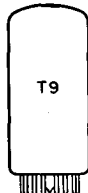
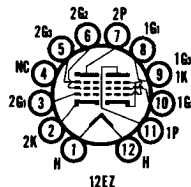

**ELECTRICAL DATA**

**HEATER OPERATION**

	<b>12T10</b>	<b>6T10</b>
Heater Voltage.....	12.6	6.3 Volts
Heater Current .....	450	950 Ma
Heater Warm-up Time .....	11	— Seconds
Maximum Heater-Cathode Voltage		
Heater Negative with Respect to Cathode		
Total DC and Peak.....		200 Volts
Heater Positive with Respect to Cathode		
DC .....		100 Volts
Total DC and Peak.....		200 Volts

**DIRECT INTERELECTRODE CAPACITANCES (Unshielded)**

**Section No. 1**

Grid to Plate .....	0.22 Pf
Input: $g$ to $(h + 1k + 1g^2 + 1g^3 + 1S)$ .....	11.0 Pf
Output: $p$ to $(h + 1k + 1g^2 + 1g^3 + 1S)$ .....	10.0 Pf

**Section No. 2**

Grid No. 1 to Plate .....	0.032 Pf
Grid No. 3 to Plate .....	3.0 Pf
Grid No. 1 to $(h + 2k + 2g^2 + 2g^3 + 1S)$ .....	6.5 Pf
Grid No. 3 to $(h + 2k + 2g^1 + 2g^2 + 2p + 1S)$ .....	7.5 Pf
Grid No. 1 to Grid No. 3 .....	0.12 Pf
Plate No. 1 to Plate No. 2 .....	0.13 Pf

**RATINGS (Design Maximum Rating System)**

Plate Voltage (Max.) .....	275 Volts
Screen Voltage (Max.) .....	275 Volts
Plate Dissipation (Max.) .....	10.0 Watts
Screen Dissipation (Max.) .....	2.0 Watts
Grid No. 1 Circuit Resistance	
Fixed Bias (Max.) .....	0.25 Megohm
Cathode Bias (Max.) .....	0.5 Megohm

**Section No. 2**

Plate Voltage (Max.) .....	330 Volts
Suppressor Voltage (Max.) .....	28 Volts
Screen Supply Voltage (Max.) .....	330 Volts
Positive DC Grid Voltage (Max.) .....	0 Volt
Plate Dissipation (Max.) .....	1.7 Watts
Screen Dissipation (Max.) .....	1.1 Watts

**CHARACTERISTICS AND TYPICAL OPERATION**

**Section No. 1**

**Class A1 Amplifier**

Plate Voltage .....	250 Volts
Screen Voltage.....	250 Volts
Grid No. 1 Voltage .....	-8.0 Volts
Peak AF Grid Voltage .....	8.0 Volts
Plate Resistance (Approx.) .....	100,000 Ohms
Transconductance .....	6500 $\mu$ mhos
Zero Signal Plate Current .....	35 Ma
Maximum Signal Plate Current .....	39 Ma
Zero Signal Screen Current .....	2.5 Ma
Maximum Signal Screen Current .....	7.0 Ma
Load Resistance .....	5000 Ohms
Total Harmonic Distortion (Approx.) .....	10 Percent
Maximum Signal Power Output .....	4.2 Watts

**Section No. 2**

Plate Voltage .....	150 Volts
Suppressor Voltage .....	0 Volt
Screen Voltage.....	100 Volts
Cathode Resistor .....	560 Ohms
Plate Resistance (Approx.) .....	150,000 Ohms
Transconductance (G1) .....	1000 $\mu$ mhos
Transconductance (G3) .....	400 $\mu$ mhos
Plate Current .....	1.3 Ma
Screen Current .....	2.1 Ma
Ec1 for $I_b = 30 \mu a$ .....	-4.5 Volts
Ec3 for $I_b = 50 \mu a$ .....	-4.5 Volts

Color Television Type

**HORIZONTAL OSC. and REACTANCE  
TUBE or VHF OSC. and MIXER**

**6U8A/6KD8**

5U8, 5KD8, 9U8A

**Medium Mu Triode and  
Sharp Cutoff Pentode**

Construction ..... Miniature T-6½  
 Base ..... Button 9 Pin, E9-1  
 Basing ..... 9AE  
 Outline ..... 6-2  
 Maximum Diameter ..... 0.875 In.  
 Maximum Seated Height ..... 1.937 In.  
 Maximum Overall Height ..... 2.187 In.

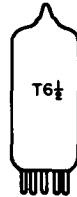
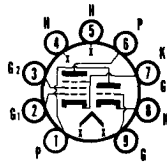

9AE

**ELECTRICAL DATA**

**HEATER OPERATION**

	9U8A	5KD8	5U8	6U8A/6KD8
Heater Voltage.....	9.45	5.6	4.7	6.3 Volts
Heater Current.....	300	450	600	450 Ma
Heater Warm-up Time.....	11	11	11	11 Seconds
Maximum Heater-Cathode Voltage				
Heater Negative with Respect to Cathode				
Total DC and Peak.....				200 Volts
Heater Positive with Respect to Cathode				
DC.....				100 Volts
Total DC and Peak.....				200 Volts

**DIRECT INTERELECTRODE CAPACITANCES**

	Shielded (1)	Unshielded
<b>Pentode Section</b>		
Grid No. 1 to Plate (Max.).....	0.007	0.015 Pf
Input: g1 to (h + k + g2 + g3 + IS).....	5.0	5.0 Pf
Output: p to (h + k + g2 + g3 + IS).....	3.5	2.6 Pf
Cathode to Heater.....	3.0	3.0 Pf
<b>Triode Section</b>		
Grid to Plate.....	1.8	1.8 Pf
Input: g to (h + Pk + Tk + g3 + IS).....	2.8	2.8 Pf
Output: p to (h + Pk + Tk + g3 + IS).....	2.0	1.5 Pf
Cathode to Heater.....	3.0	3.0 Pf
<b>Coupling</b>		
Pentode Grid No. 1 to Triode Plate (Max.).....	0.2	0.2 Pf
Pentode Plate to Triode Plate (Max.).....	0.02	0.1 Pf

**RATINGS (Design Maximum Rating System)**

	Triode Section	Pentode Section
Plate Voltage (Max.).....	330	330 Volts
Grid No. 2 Supply Voltage (Max.).....	—	330 Volts
Grid No. 2 Voltage.....	See Rating Chart (Gen. Info. Sec.)	
Positive DC Grid No. 1 Voltage.....	0	0 Volt
Plate Dissipation (Max.).....	2.5	3.0 Watts
Grid No. 2 Dissipation (Max.).....	0	0.55 Watt
Grid No. 1 Circuit Resistance		
Fixed Bias (Max.).....	—	0.5 Megohm
Self Bias (Max.).....	—	1.0 Megohm

**CHARACTERISTICS AND TYPICAL OPERATION**

	Triode Section	Pentode Section
Plate Voltage.....	125	125 Volts
Grid No. 2 Voltage.....	—	110 Volts
Grid No. 1 Voltage.....	-1.0	-1.0 Volts
Plate Current.....	13.5	9.5 Ma
Grid No. 2 Current.....	—	3.5 Ma
Transconductance.....	7500	5000 μmhos
Amplification Factor.....	40	—
Plate Resistance (Approx.).....	—	0.2 Megohm
Ec1 for Ib = 20 μa (Approx.).....	-9	-8 Volts

**NOTE:**

(1) External shielded No. 315 connected to cathode of section under test.

**AVERAGE PLATE CHARACTERISTICS  
(Pentode Section)**

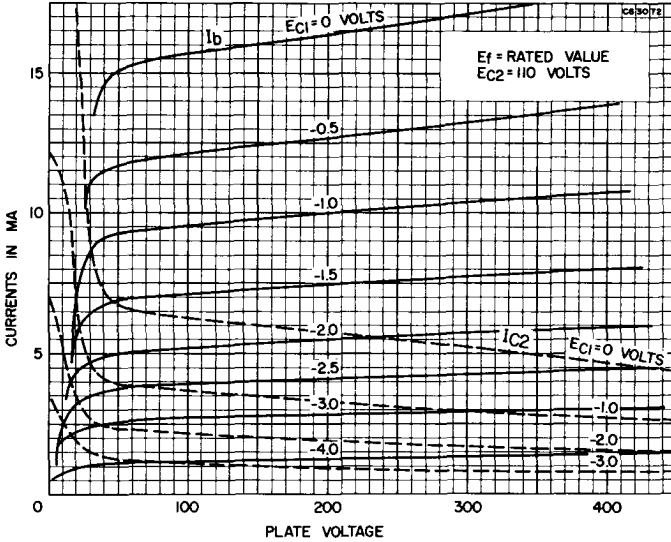

**AVERAGE PLATE CHARACTERISTICS  
(Triode Section)**

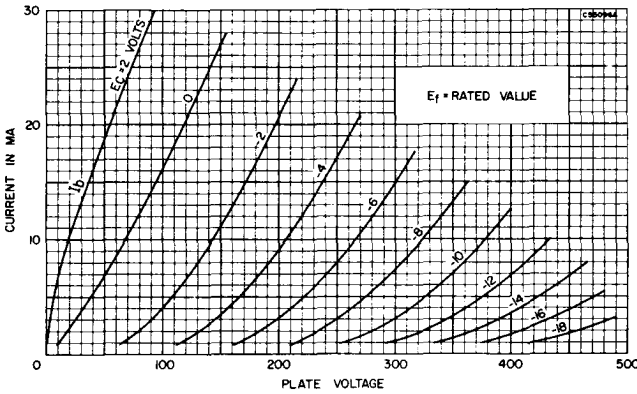

**6U9**  
5U9/LCF201, 8U9

**IF AMPLIFIER (P)  
SYNC SEPARATOR or OSC. (T)**

**Triode and Pentode**

- Construction ..... Miniature T-6½
- Base ..... Button 10 Pin
- Basing ..... 10K
- Outline ..... 6-2
- Maximum Diameter ..... 0.875 in.
- Maximum Seated Height ..... 1.937 in.
- Maximum Overall Height ..... 2.187 in.

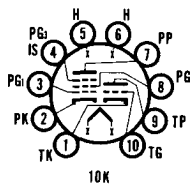



**ELECTRICAL DATA**

**HEATER OPERATION**

	8U9	5U9/LCF201	6U9
Heater Voltage.....	8.0	5.9	6.3 Volts
Heater Current.....	300	450	410 Ma
Maximum Heater-Cathode Voltage.....	165	110	165 Volts

**DIRECT INTERELECTRODE CAPACITANCES**

**Pentode Section**

Plate to All Other Elements (Except Grid No. 1).....	3.5 Pf
Grid No. 1 to All Other Elements (Except Plate).....	6.5 Pf
Grid No. 1 to Cathode.....	4.0 Pf
Plate to Grid No. 1.....	0.0065 Pf
Grid No. 1 to Grid No. 2.....	1.8 Pf

**Triode Section**

Plate to All Other Elements (Except Grid).....	3.0 Pf
Grid to All Other Elements (Except Plate).....	2.5 Pf
Plate to Grid.....	2.0 Pf

**Between Pentode and Triode Section**

Plate of Pentode to Plate of Triode.....	0.015 Pf
Control Grid of Pentode to Plate of Triode.....	0.0012 Pf
Control Grid of Pentode to Grid of Triode.....	0.0015 Pf

**RATINGS (Absolute Maximum Rating System)**

**Pentode Section**

Plate Voltage (Zero Plate Current).....	600 Volts
Plate Voltage.....	275 Volts
Plate Dissipation.....	2.4 Watts
Grid No. 2 Voltage (Zero Grid Current).....	600 Volts
Grid No. 2 Voltage.....	275 Volts
Grid No. 2 Dissipation.....	0.8 Watt
Cathode Current.....	20 Ma
Grid No. 1 Resistor.....	1 Megohm

**Triode Section**

Plate Voltage (Zero Plate Current).....	600 Volts
Plate Voltage.....	275 Volts
Plate Dissipation.....	1.75 Watts
Cathode Current.....	20 Ma
Peak Cathode Current.....	55 Ma
Grid Resistor.....	1 Megohm

**CHARACTERISTICS AND TYPICAL OPERATION**

**Pentode Section**

Plate Voltage.....	160 Volts
Grid No. 2 Voltage.....	110 Volts
Grid No. 3 Voltage.....	0 Volt
Grid No. 1 Voltage.....	-1.4 Volts
Plate Current.....	13 Ma
Grid No. 2 Current.....	5 Ma
Transconductance.....	12,000 $\mu$ mhos
Amplification Factor (Grid No. 1 to Grid No. 2).....	45

**Triode Section**

Plate Voltage.....	100 Volts
Grid Voltage.....	-2 Volts
Plate Current.....	14 Ma
Transconductance.....	5000 $\mu$ mhos
Amplification Factor.....	17

**OPERATING CHARACTERISTICS**

**Pentode Section—Video IF Amplifier**

Supply Voltage.....	135	230	250 Volts
Grid No. 3 Voltage.....	0	0	0 Volt
Plate Resistance.....	0	5.6	6.8 K Ohms
Grid No. 2 Resistor.....	5.1	24	27 K Ohms
Cathode Resistor.....	78	78	74 Ohms
Plate Current.....	13	13	13.5 Ma
Grid No. 2 Current.....	5	5	5.2 Ma
Transconductance.....	12,000	12,000	12,300 $\mu$ mhos
Grid No. 1 Circuit Resistance (40 MHz).....	7.4	7.4	7.4 K Ohms

**Triode Section—Line Blocking Oscillator**

Plate Voltage.....	30 Volts
Grid Voltage.....	1.5 Volts
Peak Cathode Current.....	40 Ma
Peak Plate Current.....	25 Ma
Peak Grid Current.....	15 Ma

**Triode Section—Sync Separator**

Plate Voltage.....	130-150 Volts
Plate Resistance.....	33 K Ohms
Grid Current.....	1 $\mu$ a
Plate Current.....	72 Ma

# 6U10

## Color Television Type GENERAL PURPOSE AMPLIFIER

### Two Medium Mu Triodes and One High Mu Triode

Construction..... Compactron T-9  
 Base ..... Button 12 Pin, E12-70  
 Basing ..... 12FE  
 Outline ..... 9-56  
 Maximum Diameter ..... 1.188 In.  
 Maximum Seated Height ..... 1.500 In.  
 Maximum Overall Height ..... 1.875 In.

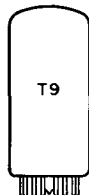
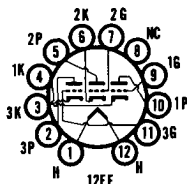

### ELECTRICAL DATA

#### HEATER OPERATION

Heater Voltage.....	6.3 Volts
Heater Current.....	600 Ma
Heater Warm-up Time.....	11 Seconds
Maximum Heater-Cathode Voltage	
Heater Negative with Respect to Cathode	
Total DC and Peak.....	200 Volts
Heater Positive with Respect to Cathode	
DC.....	100 Volts
Total DC and Peak.....	200 Volts

#### DIRECT INTERELECTRODE CAPACITANCES (Unshielded)

	Section No. 1	Section No. 2	Section No. 3
Grid to Plate.....	1.3	1.3	1.2 Pf
Input: g to (h + k).....	1.7	1.5	1.8 Pf
Output: p to (h + k).....	0.26	0.28	0.9 Pf

#### RATINGS (Design Maximum Rating System)

	Sections No. 1 and 3	Section No. 2
Plate Voltage (Max.).....	330	330 Volts
Plate Dissipation (Max.).....	2.0	1.0 Watts
Cathode Current (Max.).....	20	— Ma
Positive Grid Voltage (Max.).....	0	0 Volt
Negative Grid Voltage (Max.).....	50	50 Volts
Grid Circuit Resistance		
Fixed Bias (Max.).....	1.0	0.5 Megohm
Cathode Bias (Max.).....	2.2	1.0 Megohms

### AVERAGE PLATE CHARACTERISTICS (Sections 1 and 3)

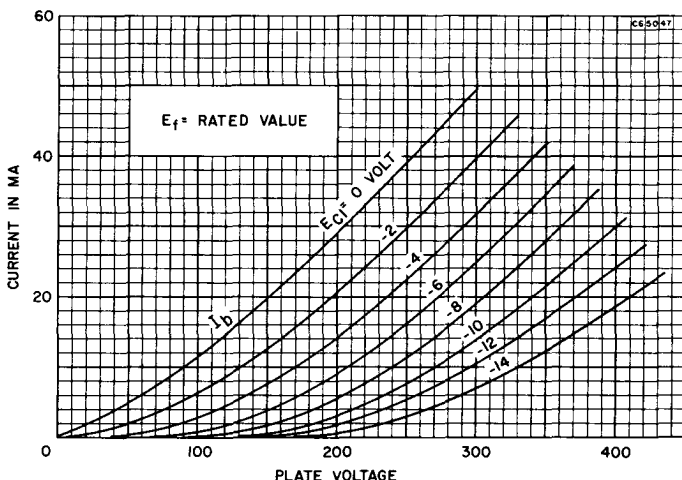

**AVERAGE PLATE CHARACTERISTICS**  
(Section No. 2)

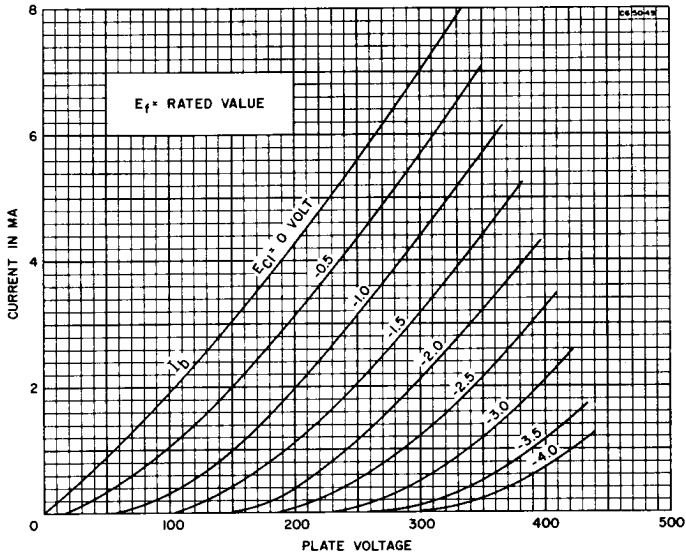

**CHARACTERISTICS AND TYPICAL OPERATION**  
Class A1 Amplifier

	<b>Sections No. 1 and 3</b>	<b>Section No. 2</b>
Plate Voltage .....	200	200 Volts
Grid Voltage .....	-6.0	-1.5 Volts
Plate Current .....	9.6	1.2 Ma
Plate Resistance .....	7700	61,000 Ohms
Transconductance .....	2300	1600 $\mu$ mhos
Amplification Factor .....	17.5	98
Ec for Ib = 100 $\mu$ a .....	-15	— Volts
Ec for Ib = 35 $\mu$ a .....	—	-3 Volts

**DAMPER**

**6V3A**

**Heater Cathode Diode**

- Construction ..... Miniature T-6½
- Base ..... Button 9 Pin, E9-1
- Top Cap ..... C1-2
- Basing ..... 9BD
- Outline ..... .6-101
- Maximum Diameter ..... 0.875 In.
- Maximum Seated Height ..... 2.625 In.
- Maximum Overall Height ..... 3.125 In.

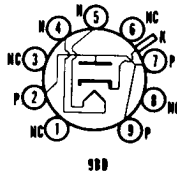

**ELECTRICAL DATA**  
**HEATER OPERATION**

Heater Voltage.....	6.3 Volts
Heater Current .....	1750 Ma
Maximum Heater-Cathode Voltage	
Heater Negative with Respect to Cathode	
DC .....	750 Volts
Total DC and Peak.....	6750 Volts
Heater Positive with Respect to Cathode	
DC .....	100 Volts
Total DC and Peak.....	300 Volts

**RATINGS (Design Center Rating System)**

**Damper Service<sup>(2)</sup>**

Peak Inverse Plate Voltage (Abs. Max.) <sup>(1)</sup> .....	6000 Volts
Plate Dissipation .....	2.7 Watts
Steady State Peak Plate Current .....	800 Ma
DC Output Current .....	135 Ma

**CHARACTERISTICS AND TYPICAL OPERATION**

Tube Voltage Drop Ib = 250 Ma DC .....	19 Volts
--	----------

**NOTES:**

- (1) Should not be exceeded under any condition of high line voltage or misadjustment.
- (2) For operation in a 525 line, 30 frame system as described in "Standards of Good Engineering Practice for Television Broadcast Stations; Federal Communications Commission," the duty cycle of the voltage pulse must not exceed 15% of one horizontal scanning cycle.

**6V6GTA**  
5V6GT, 12V6GT

*Color Television Type*  
**AUDIO POWER AMPLIFIER or  
VERTICAL DEFLECTION AMPLIFIER**

**Beam Power Pentode**

Construction .....	Octal T-9
Base .....	Octal 6 or 7 Pin, B6-81 B6-84, B7-7 or B7-59
Basing .....	7S
Outline .....	9-11 or 9-41
Maximum Diameter .....	1.188 In.
Maximum Seated Height .....	2.750 In.
Maximum Overall Height .....	3.312 In.

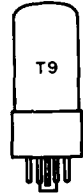
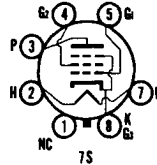

**ELECTRICAL DATA  
HEATER OPERATION**

	12V6GT	5V6GT	6V6GTA
Heater Voltage .....	12.6	4.7	6.3 Volts
Heater Current .....	225	600	450 Ma
Heater Warm-up Time .....	—	11	11 Seconds
Maximum Heater-Cathode Voltage			
Heater Negative with Respect to Cathode			
Total DC and Peak .....			200 Volts
Heater Positive with Respect to Cathode			
DC .....			100 Volts
Total DC and Peak .....			200 Volts

**DIRECT INTERELECTRODE CAPACITANCES**

Grid No. 1 to Plate .....	0.7 Pf
Input: g1 to (h + k + g2 + g3) .....	9.0 Pf
Output: p to (h + k + g2 + g3) .....	7.5 Pf

**RATINGS (Design Maximum Rating System)**

**Class A1 Amplifier**

Plate Voltage (Max.) .....	350 Volts
Grid No. 2 Voltage (Max.) .....	315 Volts
Plate Dissipation (Max.) .....	14 Watts
Grid No. 2 Dissipation (Max.) .....	2.2 Watts
Grid No. 1 Circuit Resistance	
Fixed Bias (Max.) .....	0.1 Megohm
Cathode Bias (Max.) .....	0.5 Megohm

**Vertical Deflection Amplifier<sup>(1)</sup>—Triode Connected**

Plate Voltage (Max.) .....	350 Volts
Peak Positive Plate Voltage (Abs. Max.) .....	1200 Volts
Plate Dissipation <sup>(2)</sup> .....	10 Watts
Peak Negative Grid Voltage .....	275 Volts
Average Cathode Current .....	40 Ma
Peak Cathode Current .....	115 Ma
Grid No. 1 Circuit Resistance (Cathode Bias) (Max.) .....	2.2 Megohms

**CHARACTERISTICS AND TYPICAL OPERATION**

**Class A1 Amplifier (Single Tube)**

	<b>Triode Conn.</b>		<b>Pentode Conn.</b>	
Plate Voltage .....	250	180	250	315 Volts
Grid No. 2 Voltage .....	—	180	250	225 Volts
Grid No. 1 Voltage .....	-12.5	-8.5	-12.5	-13.0 Volts
Peak AF Grid No. 1 Voltage .....	—	8.5	12.5	13.0 Volts
Zero Signal Plate Current .....	49.5	29	45	34 Ma

Maximum Signal Plate Current	—	30	47	35 Ma
Zero Signal Grid No. 2 Current	—	3	4.5	2.2 Ma
Maximum Signal Grid No. 2 Current	—	4	7.0	6 Ma
Transconductance	5000	3700	4100	3750 $\mu$ mhos
Amplification Factor	9.8	—	—	—
Plate Resistance (Approx.)	1960	50,000	50,000	80,000 Ohms
Load Resistance	—	5500	5000	8500 Ohms
Maximum Signal Power Output	—	2.0	4.5	5.5 Watts
Total Harmonic Distortion (Approx.)	—	8	8	12 Percent
E <sub>c1</sub> for I <sub>b</sub> = 0.5 Ma (Approx.)	-36	—	—	— Volts

**NOTES:**

- (1) For operation in a 525 line, 30 frame system as described in "Standards of Good Engineering Practice for Television Broadcast Stations; Federal Communications Commission," the duty cycle of the voltage pulse must not exceed 15% of one horizontal scanning cycle.
- (2) In stages operating with grid leak bias, an adequate cathode bias resistor or other suitable means is required to protect the tube in the absence of excitation.

**DAMPER**

**6W4GT**  
25W4GT

**Heater-Cathode Diode**

Construction ..... Octal T-9  
 Base ..... Octal 5 or 6 Pin, B5-82  
   B5-85, B6-8 or B6-60  
 Basing<sup>(1)</sup> ..... 4CG  
 Outline ..... 9-11 or 9-41  
 Maximum Diameter ..... 1.188 In.  
 Maximum Seated Height ..... 2.750 In.  
 Maximum Overall Height ..... 3.312 In.

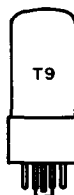
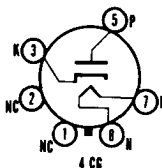

**ELECTRICAL DATA**

**HEATER OPERATION**

	25W4GT	6W4GT
Heater Voltage	25	6.3 Volts
Heater Current	300	1200 Ma
Maximum Heater-Cathode Voltage		
Heater Negative with Respect to Cathode		
DC (Abs. Max.)	500	500 Volts
Total DC and Peak (Abs. Max.)	2300	— Volts
Heater Positive with Respect to Cathode		
DC	100	100 Volts
Total DC and Peak	300	200 Volts

**DIRECT INTERELECTRODE CAPACITANCES (Unshielded)**

	6W4GT	25W4GT
Heater to Cathode	7.0	11 Pf
Plate to Cathode and Heater	6.0	6.0 Pf
Cathode to Plate and Heater	13	17 Pf

**RATINGS (Design Center Rating System)**

**Damper Service<sup>(2)</sup>**

Peak Inverse Plate Voltage (Abs. Max.)	3850 Volts
Plate Dissipation (Max.)	3.5 Watts
Steady State Peak Current (Max.)	750 Ma
DC Plate Current (Max.)	125 Ma

**CHARACTERISTICS AND TYPICAL OPERATION**

Tube Voltage Drop for I <sub>b</sub> = 250 Ma	21 Volts
---	----------

**NOTES:**

- (1) Pins 1, 2, 4, and 6 should not be used as tie points. Pin 1 omitted on bases B5-82 and B5-85.
- (2) For operation in a 525 line, 30 frame system as described in "Standards of Good Engineering Practice for Television Broadcast Stations; Federal Communications Commission," the duty cycle of the voltage pulse must not exceed 15% of one horizontal scanning cycle.

# 6W4GTA

# DAMPER

### Heater Cathode Diode

Construction .....Octal T-9  
 Base .....Octal 5 Pin, B5-82  
 Basing .....4CG  
 Outline .....9-11  
 Maximum Diameter .....1.188 In.  
 Maximum Seated Height .....2.750 In.  
 Maximum Overall Height .....3.312 In.

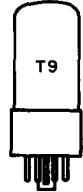
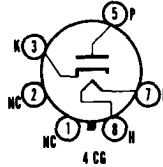

### ELECTRICAL DATA

#### HEATER OPERATION

Heater Voltage.....	6.3 Volts
Heater Current .....	1200 Ma
Maximum Heater-Cathode Voltage	
Heater Negative with Respect to Cathode	
DC .....	800 Volts
Total DC and Peak.....	3950 Volts
Heater Positive with Respect to Cathode	
DC .....	100 Volts
Total DC and Peak.....	300 Volts

#### DIRECT INTERELECTRODE CAPACITANCES (Unshielded)

Cathode to Plate and Heater.....	8.0 Pf
Plate to Cathode and Heater.....	6.0 Pf
Heater to Cathode .....	3.0 Pf

#### RATINGS (Design Maximum Rating System)

<b>Damper Service<sup>(1)</sup></b>	
Peak Inverse Plate Voltage (Abs. Max.) .....	3950 Volts
Plate Dissipation (Max.) .....	4.0 Watts
Steady State Peak Current (Max.) .....	840 Ma
DC Plate Current (Max.) .....	140 Ma
<b>CHARACTERISTICS AND TYPICAL OPERATION</b>	
Tube Voltage Drop for Ib = 250 Ma .....	21 Volts

#### NOTE:

(1) For operation in a 525 line, 30 frame system as described in "Standards of Good Engineering Practice for Television Broadcast Stations; Federal Communications Commission," the duty cycle of the voltage pulse must not exceed 15% of one horizontal scanning cycle.

# 6W6GT

12W6GT, 17W6GT, 25W6GT

Color Television Type

# AUDIO POWER AMPLIFIER or VERTICAL DEFLECTION AMPLIFIER

### Beam Power Pentode

Construction .....Octal T-9  
 Base .....Octal 6 or 7 Pin, B6-81  
               B6-84, B7-7 or B7-59  
 Basing.....7S  
 Outline .....9-11 or 9-41  
 Maximum Diameter .....1.188 In.  
 Maximum Seated Height .....2.750 In.  
 Maximum Overall Height .....3.312 In.

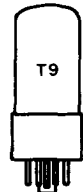
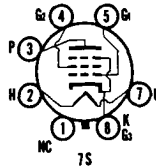

### ELECTRICAL DATA

#### HEATER OPERATION

	25W6GT	17W6GT	12W6GT	6W6GT
Heater Voltage.....	25	16.8	12.6	6.3 Volts
Heater Current .....	300	450	600	1200 Ma
Heater Warm-up Time .....	—	11	11	— Seconds
Maximum Heater-Cathode Voltage				
Heater Negative with Respect to Cathode				
Total DC and Peak.....				200 Volts
Heater Positive with Respect to Cathode				
DC .....				100 Volts
Total DC and Peak.....				200 Volts

**DIRECT INTERELECTRODE CAPACITANCES**

Grid to Plate .....	0.8 Pf
Input .....	15 Pf
Output .....	9.0 Pf

**RATINGS (Design Maximum Rating System)**

**Class A1 Amplifier**

Plate Voltage (Max.) .....	330 Volts
Grid No. 2 Voltage (Max.) .....	165 Volts
Plate Dissipation (Max.) .....	12 Watts
Grid No. 2 Dissipation (Max.) .....	1.35 Watts
Grid No. 1 Circuit Resistance	
Fixed Bias (Max.) .....	0.1 Megohm
Cathode Bias (Max.) .....	0.5 Megohm

**Vertical Deflection Amplifier—Triode Connected<sup>(1)</sup>**

DC Plate Voltage (Max.) .....	330 Volts
Peak Positive Plate Voltage (Abs. Max.) .....	1200 Volts
Plate Dissipation (Max.) .....	8.5 Watts
Peak Negative Grid Voltage (Max.) .....	275 Volts
Average Cathode Current (Max.) .....	65 Ma
Peak Cathode Current (Max.) .....	195 Ma
Grid No. 1 Circuit Resistance Cathode Bias (Max.) .....	2.2 Megohm

**CHARACTERISTICS AND TYPICAL OPERATION**

**Class A1 Amplifier**

Plate Voltage .....	110	200 Volts
Grid No. 2 Voltage .....	110	125 Volts
Grid No. 1 Voltage .....	-7.5	— Volts
Cathode Bias Resistor .....	—	180 Ohms
Peak AF Grid No. 1 Voltage .....	7.5	8.5 Volts
Plate Current (Zero-Signal) .....	49	46 Ma
Plate Current (Maximum Signal) .....	50	47 Ma
Grid No. 2 Current (Zero Signal) .....	4.0	2.2 Ma
Grid No. 2 Current (Maximum Signal) .....	10	8.5 Ma
Plate Resistance (Approx.) .....	13,000	28,000 Ohms
Transconductance .....	8000	8000 $\mu$ mhos
Load Resistance .....	2000	4000 Ohms
Maximum Signal Power Output .....	2.1	3.8 Watts
Total Harmonic Distortion (Approx.) .....	10	10 Percent

**Triode Connected**

Plate Voltage .....	225 Volts
Grid No. 1 Voltage .....	-30 Volts
Plate Current .....	22 Ma
Transconductance .....	3800 $\mu$ mhos
Amplification Factor .....	6.2
Plate Resistance .....	1600 Ohms
Grid No. 1 Voltage (Approx.) for Ib = 0.5 Ma .....	-42 Volts

**NOTES:**

- (1) For operation in a 525 line, 30 frame system as described in "Standards of Good Engineering Practice for Television Broadcast Stations; Federal Communications Commission," the duty cycle of the voltage pulse must not exceed 15% of one horizontal scanning cycle.
- (2) In stages operating with grid leak bias, an adequate cathode bias resistor or other suitable means is required to protect the tube in the absence of excitation.

**FULL-WAVE POWER RECTIFIER**

**6X4**

**12X4**

**Heater-Cathode Twin Diode**

Construction .....	Miniature T-5½
Base .....	Button 7 Pin, E7-1
Basing .....	.5BS
Outline .....	5-3
Maximum Diameter .....	0.750 In.
Maximum Seated Height .....	2.375 In.
Maximum Overall Height .....	2.625 In.

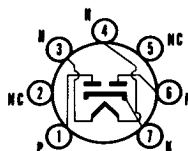

5-BS



**ELECTRICAL DATA  
HEATER OPERATION**

Heater Voltage .....	12.6	<b>12X4</b>	<b>6X4</b>
Heater Current .....	300	300	6.3 Volts 600 Ma

Maximum Heater-Cathode Voltage	
Heater Negative with Respect to Cathode .....	450 Volts
Heater Positive with Respect to Cathode .....	100 Volts
<b>RATINGS (Design Center Rating System)</b>	
Peak Inverse Plate Voltage .....	1250 Volts
AC Plate Supply Voltage (RMS) with DC Output Current of 35 Ma Per Plate .....	325 Volts
Steady State Peak Plate Current .....	210 Ma
Rectification Efficiency to keep within Steady State Peak Current Rating at 35 Ma Per Plate .....	67.5 Percent
Transient Peak Plate Current Per Plate <sup>(1)</sup> .....	1.0 Ampere
Minimum Plate Supply Resistance Per Plate for 325 Volt RMS Supply .....	325 Ohms
Tube Voltage Drop (70 Ma Per Plate) .....	22 Volts
DC Output Current Each Plate with 325 Volts AC Plate Supply Voltage (RMS) Capacitor Input to Filter .....	35 Ma
Choke Input to Filter .....	42 Ma

**CHARACTERISTICS AND TYPICAL OPERATION**

**Full Wave Rectifier**

	Input to Filter Capacitor Choke	
AC Plate Supply Voltage Per Plate (RMS) .....	325	450 Volts
Filter Input Capacitor <sup>(2)</sup> .....	10	— $\mu$ f
Filter Input Choke (Minimum) .....	—	10 Henrys
Total Effective Plate Supply Impedance (Per Plate) <sup>(2)</sup> .....	525	— Ohms
DC Output Current .....	70	70 Ma
DC Output Voltage at Filter Input (Approx.)		
For DC Cathode Current of 35 Ma .....	365	395 Volts
For DC Cathode Current of 70 Ma .....	310	385 Volts
Difference (Voltage Regulation) .....	55	10 Volts
Percentage Regulation .....	15	2.5 Percent

**NOTES:**

- (1) If capacitor input circuits are to be used, protect the circuits against the possibility of hot-switching and do not exceed a maximum peak current value of one (1) ampere during the initial cycles of the hot-switching transient.
- (2) When a filter capacitor larger than 10  $\mu$ f is used, it may be necessary to add additional plate supply impedance to limit the hot-switching transient plate current to rated maximum.



**Heater-Cathode Twin Diode**

Construction .....	Octal T-9
Base .....	Octal 6 Pin
Basing .....	.6S
Outline .....	9-11
Maximum Diameter .....	1.188 In.
Maximum Seated Height .....	2.750 In.
Maximum Overall Height .....	3.212 In.

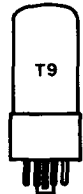
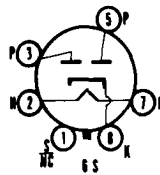

**ELECTRICAL DATA**

**HEATER OPERATION**

Heater Voltage .....	6.3 Volts
Heater Current .....	600 Ma
Maximum Heater-Cathode Voltage .....	450 Volts

**RATINGS (Design Center Rating System)**

Peak Inverse Voltage (Max.) .....	1250 Volts
Steady State Peak Plate Current (Each Plate) (Max.) .....	210 Ma
Tube Voltage Drop (70 Ma Per Plate) (Max.) .....	22 Volts

**CHARACTERISTICS AND TYPICAL OPERATION**

**Capacitor Input to Filter**

Plate Voltage (Each Plate—RMS) .....	325 Volts
DC Output Current .....	70 Ma
Effective Plate Supply Impedance (Each Plate) <sup>(1)</sup> .....	150 Ohms

**Choke Input to Filter**

Plate Voltage (Each Plate—RMS) .....	450 Volts
DC Output Current .....	70 Ma
Input Choke Value (Min.) .....	10 Henrys

**NOTE:**

- (1) Additional impedance may be required when a filter of more than 40  $\mu$ f is used.



Color Television Type  
**VHF OSCILLATOR and MIXER**

**6X8A**  
5X8, 9X8, 19X8

**Medium Mu Triode and Sharp Cutoff Pentode**

Construction ..... Miniature T-6½  
 Base ..... Button 9 Pin, E9-1  
 Basing ..... 9AK  
 Outline ..... 6-2  
     Maximum Diameter ..... 0.875 In.  
     Maximum Seated Height ..... 1.937 In.  
     Maximum Overall Height ..... 2.187 In.

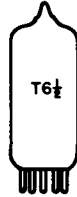
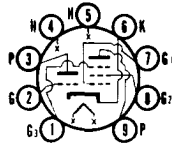

**ELECTRICAL DATA**

**HEATER OPERATION**

	19X8	9X8	5X8	6X8A
Heater Voltage.....	18.9	9.5	4.7	6.3 Volts
Heater Current .....	150	300	600	450 Ma
Heater Warm-up Time .....	—	11	11	11 Seconds
Maximum Heater-Cathode Voltage				
Heater Negative with Respect to Cathode				
Total DC and Peak .....	100	200	200	100 Volts
Heater Positive with Respect to Cathode				
DC .....	100	100	100	100 Volts
Total DC and Peak .....	100	200	200	100 Volts

**DIRECT INTERELECTRODE CAPACITANCES**

**Triode Section**

	Shielded <sup>(1)</sup>	Unshielded
Grid to Plate .....	1.4	1.4 Pf
Input .....	2.6	2.0 Pf
Output .....	1.0	0.5 Pf

**Pentode Section**

Grid No. 1 to Plate (Max.) .....	0.06	0.09 Pf
Input .....	4.5	4.3 Pf
Output .....	1.4	0.7 Pf

**Coupling**

Pentode Grid No. 1 to Triode Plate (Max.) .....	0.035	0.045 Pf
Pentode Plate to Triode Plate (Max.) .....	0.008	0.040 Pf

**RATINGS (Design Center Rating System)**

**Converter Service**

	Triode Section as Osc.	Pentode Section as Mixer
Plate Voltage (Max.) .....	250	250 Volts
Grid No. 2 Supply Voltage (Max.) .....	—	250 Volts
Grid No. 2 Voltage .....	See Rating Chart (Gen. Info. Sec.)	
Grid No. 1 Voltage		
Negative Bias (Max.) .....	40	40 Volts
Positive Bias (Max.) .....	0	0 Volt
Plate Dissipation (Max.) .....	1.5	2.0 Watts
Grid No. 2 Input (Max.) .....	—	0.4 Watt
Grid No. 1 Input (Max.) .....	0.5	— Watt
Grid No. 1 Circuit Resistance		
Fixed Bias (Max.) .....	0.1	0.1 Megohm
Cathode Bias (Max.) .....	0.5	0.5 Megohm

**CHARACTERISTICS AND TYPICAL OPERATION**

	Triode Section as 250 MHz Osc.	Pentode Section as Mixer <sup>(2)</sup>
Plate Voltage .....	150	150 Volts
Grid No. 3 .....	Connected to Cathode at Socket	
Grid No. 2 Voltage .....	—	150 Volts
Mixer Grid No. 1 Supply Voltage .....	—	-3.5 Volts
Oscillator Voltage at Mixer Grid No. 1 (RMS) .....	—	2.6 Volts
Mixer Grid No. 1 Circuit Resistance .....	—	120,000 Ohms
Oscillator Grid Resistor .....	2700	— Ohms
Conversion Transconductance .....	—	2100 μmhos
Plate Current .....	13	6.0 Ma
Grid No. 2 Current .....	—	1.8 Ma
Grid No. 1 Current .....	3.6	— Ma
Grid No. 1 Current .....	—	2.0 μa
Oscillator Power Output (Approx.) .....	0.5 <sup>(3)</sup>	— Watt

**NOTES:**

- (1) External shield No. 315 tied to cathode.
- (2) With separate excitation and triode unit grounded.
- (3) In TV or FM receivers, it is generally desirable to operate the oscillator with less power input than shown in the tabulated data in order to avoid overexcitation and excessive oscillator radiation.

**6X9/ECF200**  
5X9, 8X9

**SOUND IF or VIDEO AMP. (P)  
SYNC SEP., AGC AMP.  
SOUND IF (T)**

**Triode and Pentode**

Construction ..... Miniature T-6½  
 Base ..... Button 9 Pin, E9-1  
 Basing ..... 10K  
 Outline ..... 6-2  
 Maximum Diameter ..... 0.875 In.  
 Maximum Seated Height ..... 1.937 In.  
 Maximum Overall Height ..... 2.187 In.

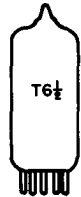
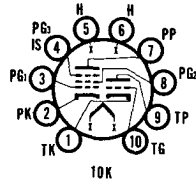

**ELECTRICAL DATA  
HEATER OPERATION**

	8X9	5X9	6X9/ECF200
Heater Voltage.....	8.0	5.9	6.3 Volts
Heater Current .....	300	450	410 Ma
Maximum Heater-Cathode Voltage			165 Volts
Pentode Section .....			165 Volts
Triode Section			
Cathode Negative			
6X9, 8X9 .....			165 Volts
5X9.....			110 Volts
Cathode Positive			
6X9, 8X9 .....			220 + 165 Volts RMS
5X9.....			220 + 110 Volts RMS

**DIRECT INTERELECTRODE CAPACITANCES (Unshielded)**

**Pentode Section**

Plate to All Other Elements (Except Grid No. 1).....	3.5 Pf
Grid No. 1 to All Other Elements (Except Plate) .....	6.5 Pf
Grid No. 1 to Cathode .....	4.0 Pf
Plate to Grid No. 1 .....	0.0065 Pf
Grid No. 1 to Grid No. 2 .....	1.8 Pf

**Triode Section**

Plate to All Other Elements (Except Grid) .....	3.0 Pf
Grid to All Other Elements (Except Plate) .....	2.5 Pf
Plate to Grid .....	2.0 Pf

**Between Pentode and Triode Section**

Plate of Pentode to Plate of Triode .....	0.015 Pf
Control Grid of Pentode to Plate of Triode .....	0.0012 Pf
Control Grid of Pentode to Grid of Triode .....	0.0015 Pf

**RATINGS (Absolute Maximum Rating System)**

**Pentode Section**

Plate Voltage (Zero Plate Current) .....	600 Volts
Plate Voltage .....	275 Volts
Plate Dissipation .....	2.4 Watts
Grid No. 2 Voltage (Zero Grid Current) .....	600 Volts
Grid No. 2 Voltage .....	275 Volts
Grid No. 2 Dissipation .....	0.8 Watts
Cathode Current .....	20 Ma
Grid No. 1 Resistor .....	1 Megohm

**Triode Section**

Peak Plate Voltage (Ib = 0.1 Ma) <sup>(1)</sup> .....	660 Volts
Plate Voltage (Zero Plate Current) .....	600 Volts
Plate Voltage .....	275 Volts
Plate Dissipation .....	1.75 Watts
Cathode Current .....	20 Ma
Grid Resistor .....	1 Megohm

**CHARACTERISTICS AND TYPICAL OPERATION**

**Pentode Section**

Plate Voltage .....	160 Volts
Grid No. 2 Voltage .....	135 Volts
Grid No. 1 Voltage .....	-1.7 Volts
Grid No. 3 Voltage .....	0 Volt

Plate Current .....			13 Ma
Grid No. 2 Current .....			5 Ma
Transconductance .....			14,000 $\mu$ mhos
Amplification Factor (Grid No. 1 to Grid No. 2) .....			55
<b>Triode Section</b>			
Plate Voltage .....			170 Volts
Grid Voltage .....			-1.0 Volt
Plate Current .....			8.5 Ma
Transconductance .....			4800 $\mu$ mhos
Amplification Factor .....			55
<b>Pentode Section—Sound or Video Amplifier</b>			
Supply Voltage .....	135	230	250 Volts
Grid No. 3 Voltage .....	0	0	0 Volt
Plate Resistance .....	0	5.6	6.8 K Ohms
Grid No. 2 Resistor .....	0	18	22 K Ohms
Cathode Resistor .....	95	100	100 Ohms
Plate Current .....	13	13.3	13.3 Ma
Grid No. 2 Current .....	4.8	4.9	4.9 Ma
Transconductance .....	14,000	14,000	14,000 $\mu$ mhos
Grid No. 1 Resistance (40 MHz) .....	6.6	6.6	6.6 K Ohms
<b>Triode Section—Sync Separator</b>			
Plate Voltage .....			130-150 Volts
Plate Resistance .....			33 K Ohms
Grid No. 1 Current .....			1 $\mu$ a
Plate Current .....			2 Ma

**NOTE:**

(1) 18  $\mu$ sec. Maximum, 18% of 1 cycle.

**AUDIO POWER AMPLIFIER**

**6Y6GA**

**Beam Power Pentode**

Construction .....	Octal T-12
Base .....	Octal 7 Pin, B7-12 or B7-119
Basing .....	7S
Outline .....	12-14
Maximum Diameter .....	1.562 In.
Maximum Seated Height .....	3.312 In.
Maximum Overall Height .....	3.875 In.

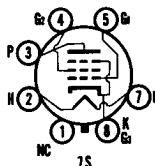

**ELECTRICAL DATA**

**HEATER OPERATION**

Heater Voltage .....	6.3 Volts
Heater Current .....	1250 Ma
Maximum Heater-Cathode Voltage .....	180 Volts

**DIRECT INTERELECTRODE CAPACITANCES**

Grid No. 1 to Plate .....	0.66 Pf
Input .....	12.0 Pf
Output .....	7.5 Pf

**RATINGS (Design Center Rating System)**

Plate Voltage (Max.) .....	200 Volts
Plate Dissipation (Max.) .....	12.5 Watts
Grid No. 2 Supply Voltage (Max.) .....	200 Volts
Grid No. 2 Voltage .....	See Rating Chart (Gen. Info. Sec.)
Grid No. 2 Dissipation (Max.) .....	1.75 Watts
Grid No. 1 Circuit Resistance .....	
Fixed Bias (Max.) .....	0.1 Megohm
Cathode Bias (Max.) .....	0.5 Megohm

**CHARACTERISTICS AND TYPICAL OPERATION**

**Class A1 Amplifier**

Plate Voltage .....	135	200 Volts
Grid No. 2 Voltage .....	135	135 Volts
Grid No. 1 Voltage .....	-13.5	-14 Volts
Peak AF Grid No. 1 Voltage .....	13.5	14 Volts
Zero Signal Plate Current .....	58	61 Ma
Maximum Signal Plate Current .....	60	66 Ma
Zero Signal Grid No. 2 Current .....	3.5	2.2 Ma
Maximum Signal Grid No. 2 Current .....	11.5	9 Ma
Plate Resistance (Approx.) .....	9300	18,300 Ohms
Transconductance .....	7000	7100 $\mu$ mhos
Load Resistance .....	2000	2600 Ohms
Maximum Signal Power Output .....	3.6	6 Watts
Total Harmonic Distortion (Approx.) .....	10	10 Percent

**6Y9**

11Y9/LFL200, 17Y9

Color Television Type

**VIDEO AMPLIFIER, SOUND IF,  
AGC AMP. or SYNC SEP.**

**Double Dissimilar Pentode**

Construction ..... Miniature T-6½  
 Base ..... Button 9 Pin, E9-1  
 Basing ..... 10L  
 Outline  
 Maximum Diameter ..... 0.875 In.  
 Maximum Seated Height ..... 2.625 In.  
 Maximum Overall Height ..... 2.875 In.

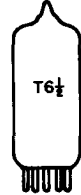
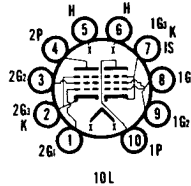

**ELECTRICAL DATA**

**HEATER OPERATION**

	<b>17Y9</b>	<b>11Y9/LFL200</b>	<b>6Y9</b>
Heater Voltage.....	17.0	11.0	6.3 Volts
Heater Current.....	300	450	800 Ma
Maximum Heater-Cathode Voltage			
Heater Negative with Respect to Cathode			
Total DC and Peak.....			200 Volts
Heater Positive with Respect to Cathode			
DC.....			100 Volts
Total DC and Peak.....			200 Volts

**DIRECT INTERELECTRODE CAPACITANCES (Unshielded)**

**Pentode No. 1**

Plate to All Other Elements (Except Grid No. 1).....	7 Pf
Grid No. 1 to All Other Elements (Except Plate).....	12 Pf
Plate to Grid No. 1 .....	0.095 Pf

**Pentode No. 2**

Plate to All Other Elements (Except Grid No. 1).....	11 Pf
Grid No. 1 to All Other Elements (Except Plate).....	10 Pf
Plate to Grid No. 1 .....	0.140 Pf
Grid No. 1 to Heater .....	0.100 Pf

**Between Pentode No. 1 and Pentode No. 2**

Plate to Plate .....	0.150 Pf
Grid to Grid .....	0.010 Pf
Plate of Pentode No. 1 to Control Grid of Pentode No. 2 .....	0.100 Pf
Plate of Pentode No. 2 to Control Grid of Pentode No. 2 .....	0.005 Pf

**RATINGS (Absolute Maximum Rating System)**

**Pentode No. 1**

Plate Voltage (Zero Plate Current) .....	600 Volts
Plate Voltage .....	275 Volts
Grid No. 2 Voltage (Zero Grid Current) .....	600 Volts
Grid No. 2 Voltage .....	275 Volts
Plate Dissipation .....	5.8 Watts
Grid No. 2 Dissipation <sup>(1)</sup> .....	2.9 Watts
Cathode Current <sup>(2)</sup> .....	66 Ma
Grid No. 1 Resistance .....	1 Megohm

**Pentode No. 2**

Plate Voltage (Zero Plate Current) .....	600 Volts
Plate Voltage .....	275 Volts
Grid No. 2 Voltage (Zero Grid Current) .....	600 Volts
Grid No. 2 Voltage .....	275 Volts
Plate Dissipation .....	1.75 Watts
Grid No. 2 Dissipation .....	0.6 Watt
Cathode Current .....	16.5 Ma
Grid No. 1 Resistance .....	1 Megohm

**CHARACTERISTICS AND TYPICAL OPERATION**

	<b>Pentode No. 1</b>	<b>Pentode No. 2</b>
Plate Voltage .....	170	150 Volts
Grid No. 2 Voltage .....	170	150 Volts
Grid No. 1 Voltage .....	-2.6	-2.3 Volts
Plate Current .....	30	10 Ma
Grid No. 2 Current .....	6.5	3.0 Ma
Transconductance .....	21,000	8500 μmhos
Amplification Factor (Grid No. 1 to Grid No. 2) .....	38	35
Internal Resistance .....	40	160 K Ohms

**Pentode No. 1—Video Output**

Supply Voltage .....	135	135	230	250	250	Volts
Supply Series Resistor .....	0	0	820	1200	0	Ohms
Voltage at Ebb .....	—	—	190	190	0	Volts
Plate Resistance .....	2.2	4.7	2	3.9	3.3	K Ohms
Grid No. 2 Resistor .....	0	0	1	1	3.9	K Ohms
Cathode Resistor .....	6.8	6.8	6.8	6.8	15	Ohms
Peak to Peak Input Signal .....	2.5	1.4	3.6	1.8	5.5	Volts
Peak to Peak Output Signal .....	90	90	100	100	160	Volts

**Pentode No. 2—Sync Separator**

Supply Voltage .....	100-140	200-250	Volts
Plate Resistance .....	50	50	K Ohms
Grid No. 2 Voltage .....	75	75	Volts
Grid No. 1 Resistor .....	1	1	Megohm
Grid No. 1 Voltage .....	-2.6	-2.7	Volts
Plate Current .....	0.1	0.1	Ma
Transconductance .....	250	200	$\mu$ mhos

**Pentode No. 2**

	<b>AGC Amplifier</b>	<b>IF Amplifier</b>	
Plate Voltage .....	100-150	135	150
Grid No. 2 Voltage .....	60	135	150
Grid No. 1 Voltage .....	-1.3	-1.9	-2.3
Plate Current .....	1.0	10	10
Transconductance .....	2500	8700	8500
			$\mu$ mhos

**NOTES:**

- (1) For short periods, cathode current = 85 Ma (Max.)
- (2) For short periods, cathode current = 93 Ma (Max.)

**LIMITER/DISCRIMINATOR  
and AUDIO POWER AMPLIFIER**

**6Z10**

10Z10

**Gated Beam Pentode and  
Beam Power Pentode**

Construction .....	Compactron T-9
Base .....	Button 12 Pin, E12-70
Basing .....	12BT
Outline .....	9-58
Maximum Diameter .....	1.188 In.
Maximum Seated Height .....	2.000 In.
Maximum Overall Height .....	2.375 In.

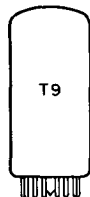
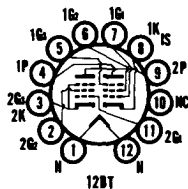

**ELECTRICAL DATA**

**HEATER OPERATION**

	<b>10Z10</b>	<b>6Z10</b>	
Heater Voltage .....	10.0	6.3	Volts
Heater Current .....	600	950	Ma
Heater Warm-up Time .....	11	—	Seconds
Maximum Heater-Cathode Voltage			
Heater Negative with Respect to Cathode			
Total DC and Peak .....		200	Volts
Heater Positive with Respect to Cathode			
DC .....		100	Volts
Total DC and Peak .....		200	Volts

**DIRECT INTERELECTRODE CAPACITANCES**

**Gated-Beam Discriminator Section No. 1**

Grid No. 1 to Grid No. 3 .....	0.009	Pf
Grid No. 1 to All .....	4.4	Pf
Grid No. 3 to All .....	3.2	Pf

**Pentode Section No. 2**

Grid No. 1 to Plate .....	0.22	Pf
Input .....	11	Pf
Output .....	7.5	Pf

**RATINGS (Design Maximum Rating System)**

**Gated Beam Discriminator Section No. 1**

Plate Supply Voltage (Max.) .....	330	Volts
Accelerator-Supply Voltage (Max.) .....	330	Volts
Peak Positive Grid No. 1 Voltage (Max.) .....	60	Volts
DC Cathode Current (Max.) .....	13	Ma

**Pentode Section No. 2**

Plate Voltage (Max.) .....	275	Volts
Screen Voltage (Max.) .....	275	Volts

Plate Dissipation (Max.) .....	10 Watts
Screen Dissipation (Max.) .....	2.0 Watts
Grid No. 1 Circuit Resistance	
With Fixed Bias (Max.) .....	0.25 Megohm
With Cathode Bias (Max.) .....	0.5 Megohm

**CHARACTERISTICS AND TYPICAL OPERATION**

**Gated Beam Discriminator Section**

Plate Voltage .....	135	135	135 Volts
Accelerator Voltage .....	75	—	— Volts
Accelerator-Supply Voltage .....	—	280	280 Volts
Accelerator Resistor .....	—	33,000	33,000 Ohms
Grid No. 1 Voltage .....	0	0	0 Volt
Grid No. 3 Voltage .....	+4.0	+4.0	0 Volts
Plate Current .....	—	5.0	— Ma
Accelerator Current .....	4.5	—	— Ma
Grid No. 1 Transconductance .....	—	—	360 $\mu$ mhos
Grid No. 3 Transconductance .....	—	—	700 $\mu$ mhos
Grid No. 1 Voltage (Approx.) $I_b = 20 \mu a$ .....	—	—	-4 Volts
Grid No. 3 Voltage (Approx.) $I_b = 20 \mu a$ .....	—	—	-4 Volts

**Pentode Section**

Plate Voltage .....	250 Volts
Screen Voltage .....	250 Volts
Grid No. 1 Voltage .....	-8.0 Volts
Peak AF Grid No. 1 Voltage .....	8.0 Volts
Plate Resistance (Approx.) .....	100,000 Ohms
Transconductance .....	6500 $\mu$ mhos
Zero-Signal Plate Current .....	35 Ma
Maximum-Signal Plate Current .....	39 Ma
Zero-Signal Screen Current .....	3.0 Ma
Maximum-Signal Screen Current .....	13 Ma
Load Resistance .....	5000 Ohms
Total Harmonic Distortion (Approx.) .....	8.5 Percent
Maximum-Signal Power Output .....	4.2 Watts



**Semi-Remote Cutoff Pentode and Sharp Cutoff Pentode**

Construction .....	Compactron T-9
Base .....	Button 12 Pin, E12-70
Basing .....	12FU
Outline .....	9-58
Maximum Diameter .....	1.188 In.
Maximum Seated Height .....	2.000 In.
Maximum Overall Height .....	2.375 In.

**ELECTRICAL DATA**

**HEATER OPERATION**

Heater Voltage .....	8.4 Volts
Heater Current .....	450 Ma
Heater Warm-up Time .....	11 Seconds
Maximum Heater-Cathode Voltage	
Heater Negative with Respect to Cathode	
Total DC and Peak .....	200 Volts
Heater Positive with Respect to Cathode	
DC .....	100 Volts
Total DC and Peak .....	200 Volts

**DIRECT INTERELECTRODE CAPACITANCES (Shielded)<sup>(1)</sup>**

<b>Section 1</b>	
Grid No. 1 to Plate .....	0.016 Pf
Input: 1g1 to (h + 1k + 1g2 + 1g3 + IS) .....	6.5 Pf
Output: 1p to (h + 1k + 1g2 + 1g3 + IS) .....	2.4 Pf

<b>Section 2</b>	
Grid No. 1 to Plate .....	0.015 Pf
Input: 2g1 to (h + 2k + 2g2 + 2g3 + 1g3 + IS) .....	7.5 Pf
Output: 2p to (h + 2k + 2g2 + 2g3 + 1g3 + IS) .....	2.6 Pf

**Coupling**

Grid No. 1 (Section 1) to Plate (Section 2): (1g1 to 2p) (Max.) .....	0.001 Pf
Grid No. 1 (Section 2) to Plate (Section 1): (2g1 to 1p) (Max.) .....	0.10 Pf
Grid No. 1 (Section 1) to Grid No. 1 (Section 2): (1g1 to 2g1) (Max.) .....	0.001 Pf
Plate (Section 1) to Plate (Section 2): (1p to 2p) (Max.) .....	0.002 Pf

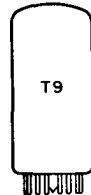
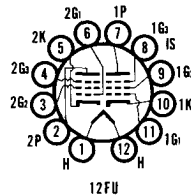

**RATINGS (Design Maximum Rating System)**

**Section 1**

Plate Voltage .....	160 Volts
Suppressor Voltage .....	0 Volt
Screen Voltage .....	160 Volts
Positive DC Grid No. 1 Voltage .....	0 Volt
Plate Dissipation .....	2.2 Watts
Screen Dissipation .....	0.55 Watt
Grid No. 1 Circuit Resistance .....	
Cathode Bias .....	1.0 Megohm

**Section 2**

Plate Voltage .....	160 Volts
Suppressor Voltage .....	0 Volt
Screen Voltage .....	160 Volts
Positive DC Grid No. 1 Voltage .....	0 Volt
Plate Dissipation .....	2.2 Watts
Screen Dissipation .....	0.55 Watt
Grid No. 1 Circuit Resistance .....	
Cathode Bias .....	0.25 Megohm

**CHARACTERISTICS AND TYPICAL OPERATION**

**Section 1**

Plate Voltage .....	125 Volts
Suppressor .....	Connected to Cathode at Socket
Screen Voltage .....	125 Volts
Cathode-Bias Resistor .....	56 Ohms
Plate Resistance (Approx.) .....	220,000 Ohms
Transconductance .....	8800 $\mu$ mhos
Plate Current .....	14 Ma
Screen Current .....	3.6 Ma
Grid No. 1 Voltage (Approx.) $G_m = 50 \mu$ mhos .....	-16.5 Volts

**Section 2**

Plate Voltage .....	125 Volts
Suppressor .....	Connected to Cathode at Socket
Screen Voltage .....	125 Volts
Cathode-Bias Resistor .....	120 Ohms
Plate Resistance (Approx.) .....	300,000 Ohms
Transconductance .....	8500 $\mu$ mhos
Plate Current .....	9.0 Ma
Screen Current .....	2.5 Ma
Grid No. 1 Voltage (Approx.) $I_b = 20 \mu$ a .....	-5.5 Volts

**NOTE:**

(1) With external shield (EIA 309) connected to cathode of section under test.

Color Television Type

**IF AMPLIFIER**

**8BQ11**

11BQ11

**Remote Cutoff Pentode and Sharp Cutoff Pentode**

Construction .....	Compactron T-9
Base .....	Button 12 Pin, E12-70
Basing .....	12DM
Outline .....	9-58
Maximum Diameter .....	1.188 In.
Maximum Seated Height .....	2.000 In.
Maximum Overall Height .....	2.375 In.

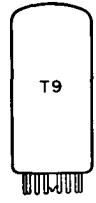
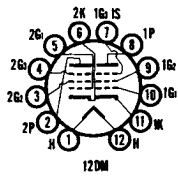

**ELECTRICAL DATA HEATER OPERATION**

Heater Voltage .....	11BQ11 11.2	8BQ11 8.4 Volts
Heater Current .....	450	600 Ma
Heater Warm-up Time .....	11	11 Seconds
Maximum Heater-Cathode Voltage .....		
Heater Negative with Respect to Cathode .....		200 Volts
Total DC and Peak .....		
Heater Positive with Respect to Cathode .....		100 Volts
DC .....		200 Volts
Total DC and Peak .....		

**DIRECT INTERELECTRODE CAPACITANCES (Shielded) (1)**

**Section 1**

Grid No. 1 to Plate .....	0.022 Pf
---------------------------	----------

Input: 1g1 to (1k + 1g2 + 1g3 + h + IS).....	10 Pf
Output: 1p to (1k + 1g2 + 1g3 + h + IS) .....	2.8 Pf

**Section 2**

Grid No. 1 to Plate .....	0.024 Pf
Input: 2g1 to (2k + 2g2 + 2g3 + 1g3 + h + IS) .....	11 Pf
Output: 2p to (2k + 2g2 + 2g3 + 1g3 + h + IS) .....	2.8 Pf

**Coupling**

Plate to Plate (Max.) .....	0.015 Pf
Grid No. 1 (Section 1) to Plate (Section 2) (Max.) .....	0.002 Pf
Grid No. 1 (Section 2) to Plate (Section 1) (Max.) .....	0.008 Pf
Grid No. 1 (Section 1) to Grid No. 1 (Section 2) (Max.) .....	0.002 Pf

**RATINGS (Design Maximum Rating System)**

**Section 1**

Plate Voltage .....	330 Volts
Suppressor Voltage .....	0 Volt
Screen-Supply Voltage .....	330 Volts
Screen Voltage .....	See Rating Chart (Gen. Info. Sec.)
Positive DC Grid No. 1 Voltage .....	0 Volt
Plate Dissipation .....	3.1 Watts
Screen Dissipation .....	0.65 Watts
Grid No. 1 Circuit Resistance .....	
Cathode Bias .....	1.0 Megohm

**Section 2**

Plate Voltage .....	330 Volts
Suppressor Voltage .....	0 Volt
Screen-Supply Voltage .....	330 Volts
Screen Voltage .....	See Rating Chart (Gen. Info. Sec.)
Positive DC Grid No. 1 Voltage .....	0 Volt
Plate Dissipation .....	3.1 Watts
Screen Dissipation .....	0.65 Watts
Grid No. 1 Circuit Resistance .....	
Cathode Bias .....	0.25 Megohm

**CHARACTERISTICS AND TYPICAL OPERATION**

**Section 1**

Plate Voltage .....	125 Volts
Suppressor .....	Connected to Cathode at Socket
Screen Voltage .....	125 Volts
Cathode-Bias Resistor .....	56 Ohms
Plate Resistance (Approx.) .....	0.2 Megohm
Transconductance .....	10,500 $\mu$ mhos
Plate Current .....	11 Ma
Screen Current .....	3.5 Ma
Grid No. 1 Voltage (Approx.) .....	
Gm = 50 $\mu$ mhos .....	-15 Volts

**Section 2**

Plate Voltage .....	125 Volts
Suppressor .....	Connected to Cathode at Socket
Screen Voltage .....	125 Volts
Cathode-Bias Resistor .....	56 Ohms
Plate Resistance (Approx.) .....	0.2 Megohm
Transconductance .....	13,000 $\mu$ mhos
Plate Current .....	11 Ma
Screen Current .....	3.8 Ma
Grid No. 1 Voltage (Approx.) .....	
Ib = 20 $\mu$ a .....	-3 Volts

**NOTE:**

(1) With external shield (EIA 309) connected to cathode of section under test.

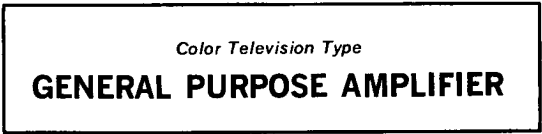

**Double Medium Mu Triode and Sharp Cutoff Pentode**

Construction.....	Compactron T-9
Base .....	Buttun 12 Pin, E12-70
Basing .....	12FP
Outline .....	9-59
Maximum Diameter .....	1.188 In.
Maximum Seated Height .....	2.250 In.
Maximum Overall Height .....	2.625 In.

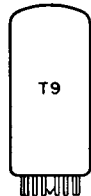
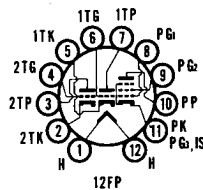



**ELECTRICAL DATA****HEATER OPERATION**

Heater Voltage.....	7.8 Volts
Heater Current .....	600 Ma
Heater Warm-up Time .....	11 Seconds
Maximum Heater-Cathode Voltage	
Heater Negative with Respect to Cathode	
Total DC and Peak.....	200 Volts
Heater Positive with Respect to Cathode	
DC .....	100 Volts
Total DC and Peak.....	200 Volts

**DIRECT INTERELECTRODE CAPACITANCES (Unshielded)****Triode (Section 1)**

Grid to Plate .....	1.7 Pf
Input: T1g to (T1k + Pk + Pg3 + h + IS) .....	3.2 Pf
Output: T1p to (T1k + Pk + Pg3 + h + IS) .....	2.0 Pf

**Triode (Section 2)**

Grid to Plate .....	1.8 Pf
Input: T2g to (T1k + T2k + Pk + Pg3 + h + IS) .....	3.0 Pf
Output: T2p to (T1k + T2k + Pk + Pg3 + h + IS) .....	1.7 Pf

**Pentode Section**

Grid No. 1 to Plate .....	0.11 Pf
Input: Pg1 to (T1k + Pk + Pg2 + Pg3 + h + IS) .....	5.0 Pf
Output: Pp to (T1k + Pk + Pg2 + Pg3 + h + IS) .....	2.4 Pf

**RATINGS (Design Maximum Rating System)****Pentode Section**

Plate Voltage .....	330 Volts
Screen Supply Voltage .....	330 Volts
Screen Voltage .....	See Rating Chart (Gen. Info. Sec.)
Positive DC Grid No. 1 Voltage .....	0 Volt
Plate Dissipation .....	2.5 Watts
Screen Dissipation.....	0.55 Watt
Grid No. 1 Circuit Resistance	
Fixed Bias .....	0.5 Megohm
Cathode Bias .....	1.0 Megohm

**Each Triode Section**

Plate Voltage .....	330 Volts
Positive DC Grid Voltage .....	0 Volt
Plate Dissipation .....	1.8 Watts
Grid Circuit Resistance	
Fixed Bias .....	0.5 Megohm
Cathode Bias .....	1.0 Megohm

**CHARACTERISTICS AND TYPICAL OPERATION****Pentode Section**

Plate Voltage .....	125 Volts
Screen Voltage.....	125 Volts
Grid No. 1 Voltage .....	-1.0 Volt
Plate Resistance (Approx.) .....	200,000 Ohms
Transconductance .....	7500 $\mu$ mhos
Plate Current .....	12 Ma
Screen Current .....	4.0 Ma
Grid No. 1 Voltage (Approx.)	
I <sub>b</sub> = 30 $\mu$ a .....	-8 Volts

**Each Triode Section**

Plate Voltage .....	125 Volts
Cathode Bias Resistor .....	68 Ohms
Amplification Factor .....	43
Plate Resistance (Approx.) .....	5000 Ohms
Transconductance .....	8600 $\mu$ mhos
Plate Current .....	13.5 Ma
Grid Voltage (Approx.)	
I <sub>b</sub> = 100 $\mu$ a .....	-8 Volts

# 9A8/PCF80

8A8, 17A8

Color Television Type

## VHF OSCILLATOR and MIXER

### Triode and Pentode

Construction ..... Miniature T-6½  
 Base ..... Button 9 Pin, E9-1  
 Basing ..... 9DC  
 Outline ..... 6-2  
 Maximum Diameter ..... 0.875 In.  
 Maximum Seated Height ..... 1.937 In.  
 Maximum Overall Height ..... 2.187 In.

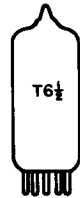
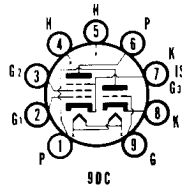

### ELECTRICAL DATA

#### HEATER OPERATION

	17A8	8A8	9A8/PCF80
Heater Voltage.....	16.8	8.4	9.0 Volts
Heater Current .....	150	300	300 Ma
Maximum Heater-Cathode Voltage			
Heater Negative with Respect to Cathode			
Total DC and Peak.....			100 Volts
Heater Positive with Respect to Cathode			
DC .....			120 Volts
Total DC and Peak.....			200 Volts

#### DIRECT INTERELECTRODE CAPACITANCES

##### Pentode Section

Input Capacitance .....	5.5 Pf
Output Capacitance.....	3.8 Pf
Plate to Grid No. 1 (Max.).....	0.025 Pf

##### Triode Section

Input Capacitance .....	2.5 Pf
Output Capacitance.....	1.8 Pf
Plate to Grid .....	1.5 Pf

##### Between Pentode and Triode Sections

Pentode Plate to Triode Plate (Max.) .....	0.07 Pf
Pentode Plate to Triode Grid (Max.) .....	0.02 Pf
Pentode Grid to Triode Plate (Max.) .....	0.16 Pf

#### RATINGS (Design Center Rating System)

##### Pentode Section

Plate Voltage (Max.) .....	250 Volts
Plate Voltage (without current) (Max.) .....	550 Volts
Plate Dissipation (Max.) .....	1.7 Watts
Grid No. 2 Voltage at a Cathode Current of 14 Ma (Max.) .....	175 Volts
Grid No. 2 Voltage at a Cathode Current less than 10 Ma (Max.) .....	200 Volts
Grid No. 2 Dissipation at a Plate Dissipation more than 1.2 Watts (Max.) .....	0.5 Watt
Grid No. 2 Dissipation at a Plate Dissipation less than 1.2 Watts (Max.) .....	0.75 Watt
Grid No. 1 Circuit Resistance with Automatic Bias (Max.) .....	1 Megohm
Grid No. 1 Circuit Resistance with Fixed Bias (Max.) .....	0.5 Megohm
Cathode Current (Max.).....	14 Ma

##### Triode Section

Plate Voltage (Max.) .....	250 Volts
Plate Voltage (without current) (Max.) .....	550 Volts
Plate Dissipation (Max.) .....	1.5 Watts
Grid Circuit Resistance (Max.) .....	0.5 Megohm
Cathode Current (Max.).....	14 Ma

#### CHARACTERISTICS AND TYPICAL OPERATION

##### Pentode Section

Plate Voltage .....	170 Volts
Grid No. 2 Voltage .....	170 Volts
Grid No. 1 Bias .....	-2 Volts
Plate Current .....	10 Ma
Grid No. 2 Current .....	2.8 Ma
Transconductance .....	6200 μmhos
Plate Resistance.....	0.4 Megohm
Amplification Factor of Grid No. 2 with Respect to Grid No. 1.....	47
Input Resistance at 50 MHz .....	10,000 Ohms
Equivalent Noise Resistance .....	1500 Ohms

##### Triode Section

Plate Voltage .....	100 Volts
Grid Voltage .....	-2 Volts
Plate Current .....	14 Ma
Transconductance .....	5000 μmhos
Amplification Factor .....	20

**OPERATING CHARACTERISTICS FOR USE AS MIXER**

Plate Voltage .....	170	170 Volts
Grid No. 2 Voltage .....	170	170 Volts
Grid No. 1 Circuit Resistance .....	0.1	0.1 Megohm
Cathode Resistor .....	330	820 Ohms
Oscillator Voltage (RMS).....	3.5	3.5 Volts
Plate Current .....	6.5	5.2 Ma
Grid No. 2 Current .....	2.0	1.5 Ma
Grid No. 1 Current .....	25	0 $\mu$ a
Conversion Conductance .....	2200	2100 $\mu$ mhos
Plate Resistance.....	0.8	0.87 Megohm

*Color Television Type*  
**CHROMA BANDPASS AMPLIFIER  
 COLOR DEMODULATOR or  
 VIDEO AMPLIFIER**

9KC6

**Frame Grid Pentode**

Construction .....	Miniature T-6½
Base .....	Button 9 Pin, E9-1
Basing .....	9RF
Outline .....	6-3
Maximum Diameter .....	0.875 In.
Maximum Seated Height .....	2.375 In.
Maximum Overall Height .....	2.625 In.

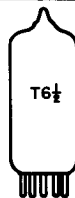
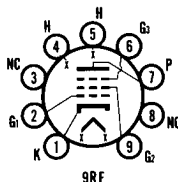

**ELECTRICAL DATA**

**HEATER OPERATION**

Heater Voltage.....	8.7 Volts
Heater Current .....	450 Ma
Heater Warm-up Time .....	11 Seconds
Maximum Heater-Cathode Voltage	
Heater Negative with Respect to Cathode	
Total DC and Peak.....	200 Volts
Heater Positive with Respect to Cathode	
DC .....	100 Volts
Total DC and Peak.....	200 Volts

**DIRECT INTERELECTRODE CAPACITANCES (Unshielded)**

Grid No. 1 to Plate (g1 to p) .....	0.20 Pf
Grid No. 3 to Plate (g3 to p) .....	2.2 Pf
Grid No. 1 to All g1 to (h + k + g2 + g3 + p) .....	16.5 Pf
Grid No. 2 to All g2 to (h + k + g1 + g3 + p) .....	9.5 Pf
Grid No. 3 to All g3 to (h + k + g1 + g2 + p) .....	7.5 Pf
Plate to All p to (h + k + g1 + g2 + g3) .....	3.0 Pf
Grid No. 1 to Grid No. 2 (g1 to g2) .....	4.7 Pf

**RATINGS (Design Maximum Rating System)**

Plate Voltage .....	400 Volts
Grid No. 2 Supply Voltage.....	330 Volts
Grid No. 2 Voltage .....	See Rating Chart (Gen. Info. Sec.)
Positive Grid No. 3 Voltage .....	0 Volt
Negative Grid No. 3 Voltage.....	100 Volts
Positive Grid No. 1 Voltage .....	0 Volt
Plate Dissipation .....	7.0 Watts
Grid No. 2 Dissipation .....	1.5 Watts
Grid No. 1 Circuit Resistance	
Self Bias .....	0.5 Megohm
Fixed Bias .....	0.25 Megohm
Grid No. 3 Circuit Resistance .....	1.0 Megohm

Control grid to cathode spacing of this type is of such low order of magnitude as to preclude the use of voltage between these elements of more than 50 volts dc or peak ac in commercial tube checkers and shorts indicating devices, particularly where mechanical excitation of the tube is employed.

**CHARACTERISTICS AND TYPICAL OPERATION**

Plate Voltage .....	250	250 Volts
Grid No. 2 Voltage .....	150	100 Volts
Grid No. 1 Voltage .....	0	-1.0 Volt
Grid No. 3 Voltage (Referred to Negative End of Rk) .....	0	-25 Volts
Cathode Resistor .....	56	0 Ohms
Plate Current .....	18	1.0 Ma
Grid No. 2 Current .....	9	13.0 Ma
Transconductance (Grid No. 1 to Plate) .....	24,000	— $\mu$ mhos
Transconductance (Grid No. 3 to Plate) .....	500	— $\mu$ mhos
Plate Resistance (Approx.) .....	55,000	— Ohms
Grid No. 1 Voltage for Ib = 100 $\mu$ a (Rk = 0) .....	-4.1	— Volt

**INSTANTANEOUS PLATE KNEE CHARACTERISTICS<sup>(1)</sup>**

$E_b = 50$  V,  $E_{c2} = 100$  V, and  $E_{c1} = 0$  V

$I_b = 25$  Ma, and  $I_{c2} = 25$  Ma

**NOTE:**

(1) Applied for short interval (2 Sec. Max.) so as not to damage tube.

**AVERAGE PLATE CHARACTERISTICS**

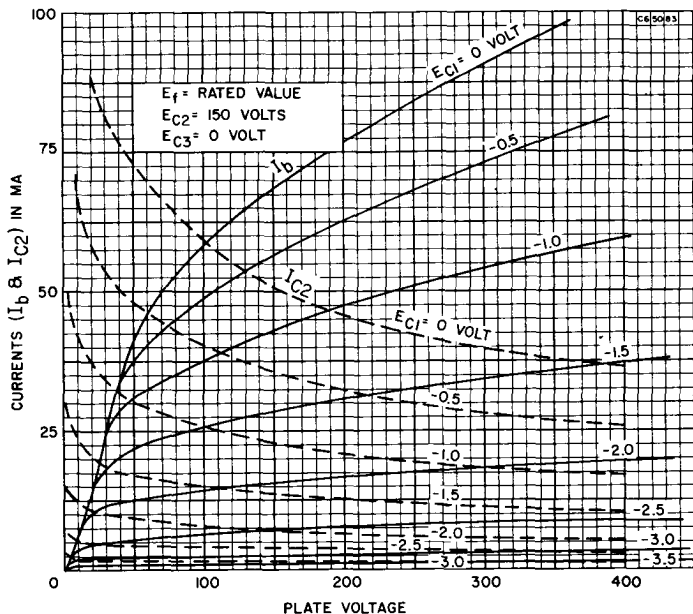

**9KX6**

Color Television Type  
**VIDEO AMPLIFIER**

**Sharp Cutoff Pentode**

- Construction ..... Miniature T-6½
- Base ..... Button 9 Pin, E9-1
- Basing ..... 9GK
- Outline ..... 6-3
- Maximum Diameter ..... 0.875 In.
- Maximum Seated Height ..... 2.375 In.
- Maximum Overall Height ..... 2.625 In.

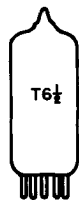
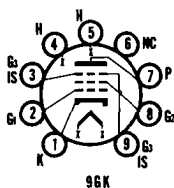

**ELECTRICAL DATA**

**HEATER OPERATION**

- Heater Voltage.....
- Heater Current.....
- Heater Warm-up Time.....
- Maximum Heater-Cathode Voltage

Heater Negative with Respect to Cathode

Total DC and Peak.....

Heater Positive with Respect to Cathode

DC.....

Total DC and Peak.....

**DIRECT INTERELECTRODE CAPACITANCES (Unshielded)**

- Grid No. 1 to Plate (g1 to p) .....
- Input: g1 to (k + g3 + IS + g2 + h).....
- Output: p to (k + g3 + IS + g2 + h).....

8.7 Volts  
450 Ma  
11 Seconds

200 Volts  
100 Volts  
200 Volts

0.12 Pf  
17.5 Pf  
4.0 Pf

**RATINGS (Design Maximum Rating System)**

Plate Voltage (Max.) .....	400 Volts
Positive DC Grid No. 3 Voltage (Max.) .....	0 Volt
Grid No. 2 Supply Voltage (Max.) .....	330 Volts
Grid No. 2 Voltage .....	See Rating Chart (Gen. Info. Sec.)
Positive DC Grid No. 1 Voltage (Max.) .....	0 Volt
Plate Dissipation (Max.) .....	11.5 Watts
Grid No. 2 Dissipation (Max.) .....	1.5 Watt
Grid No. 1 Circuit Resistance	
Fixed Bias (Max.) .....	0.1 Megohm
Cathode Bias (Max.) .....	0.25 Megohm

Control grid to cathode spacing on this type is of such low order of magnitude as to preclude the use of voltage between these elements of more than 50 Volts DC or peak AC in commercial tube checkers and shorts indicating devices, particularly where mechanical excitation of the tube is employed.

**CHARACTERISTICS AND TYPICAL OPERATION**

Plate Voltage .....	250 Volts
Grid No. 2 Supply Voltage .....	150 Volts
Grid No. 1 Voltage .....	0 Volt
Grid No. 3 Voltage (Referred to Negative End of Rk) .....	0 Volt
Cathode Resistor (Bypassed) .....	56 Ohms
Plate Current .....	28 Ma
Grid No. 2 Current .....	6.5 Ma
Transconductance (Grid No. 1 to Plate) .....	36,000 $\mu$ mhos
Plate Resistance (Approx.) .....	50,000 Ohms
Grid No. 1 Voltage, Approx. for $I_b = 100 \mu a$ .....	-5.7 Volts

**INSTANTANEOUS PLATE KNEE CHARACTERISTICS**

$E_b = 50 V$ ,  $E_{c2} = 125 V$ ,  $E_{c1} = 0 V$ , and  $E_{c3} = 0 V$   
 $I_b = 70 Ma$ , and  $I_{c2} = 24 Ma$

Color Television Type

**VIDEO AMPLIFIER**

**9LA6**

**Sharp Cutoff Pentode**

Construction .....	Miniature T-6½
Base .....	Button 9 Pin, E9-1
Basing .....	9GK
Outline .....	6-3
Maximum Diameter .....	0.875 In.
Maximum Seated Height .....	2.375 In.
Maximum Overall Height .....	2.625 In.

**ELECTRICAL DATA**

**HEATER OPERATION**

Heater Voltage .....	8.7 Volts
Heater Current .....	450 Ma
Heater Warm-up Time .....	11 Seconds
Maximum Heater-Cathode Voltage	
Heater Negative with Respect to Cathode	
Total DC and Peak .....	200 Volts
Heater Positive with Respect to Cathode	
DC .....	100 Volts
Total DC and Peak .....	200 Volts

**DIRECT INTERELECTRODE CAPACITANCES (Unshielded)**

Grid No. 1 to Plate (g1 to p) .....	0.15 Pf
Input: g1 to (k + g3 + IS + g2 + h) .....	15.0 Pf
Output: p to (k + g3 + IS + g2 + h) .....	6.0 Pf

**RATINGS (Design Maximum Rating System)**

Plate Voltage (Max.) .....	400 Volts
Positive DC Grid No. 3 Voltage (Max.) .....	0 Volt
Grid No. 2 Supply Voltage (Max.) .....	330 Volts
Grid No. 2 Voltage .....	See Rating Chart (Gen. Info. Sec.)
Positive DC Grid No. 1 Voltage .....	0 Volt
Plate Dissipation (Max.) .....	10.0 Watts
Grid No. 2 Dissipation (Max.) .....	1.0 Watt
Grid No. 1 Circuit Resistance	
Fixed Bias (Max.) .....	0.1 Megohm
Cathode Bias (Max.) .....	0.25 Megohm

Control grid to cathode spacing on this type is of such low order of magnitude as to preclude the use of voltage between these elements of more than 50 Volts DC or peak AC in commercial tube checkers and shorts indicating devices, particularly where mechanical excitation of the tube is employed.

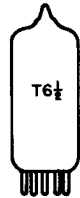
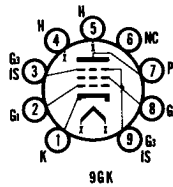

**CHARACTERISTICS AND TYPICAL OPERATION**

Plate Voltage .....	250 Volts
Grid No. 2 Supply Voltage .....	150 Volts
Grid No. 1 Voltage .....	0 Volt
Grid No. 3 Voltage (Referred to Negative End of Rk) .....	0 Volt
Cathode Resistor (Bypassed) .....	122 Ohms
Plate Current .....	25 Ma
Grid No. 2 Current .....	6 Ma
Transconductance (Grid No. 1 to Plate) .....	21,000 $\mu$ mhos
Plate Resistance (Approx.) .....	55,000 Ohms
Grid No. 1 Voltage (Approx.) for I <sub>b</sub> = 100 $\mu$ a (Rk = 0) .....	-7.2 Volts

**INSTANTANEOUS PLATE KNEE CHARACTERISTICS**

E<sub>b</sub> = 50 V, E<sub>c2</sub> = 125 V, E<sub>c1</sub> = 0 V, and E<sub>c3</sub> = 0 V  
 I<sub>b</sub> = 76 Ma, and I<sub>c2</sub> = 32 Ma

**10EG7**

**VERTICAL DEFLECTION  
OSCILLATOR and AMPLIFIER**

**Double Dissimilar Triode**

Construction .....	Octal T-9
Base .....	Octal 8 Pin, B8-58
Basing .....	8BD
Outline .....	9-38
Maximum Diameter .....	1.188 In.
Maximum Seated Height .....	2.437 In.
Maximum Overall Height .....	3.000 In.

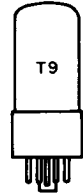
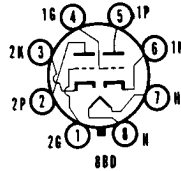

**ELECTRICAL DATA  
HEATER OPERATION**

Heater Voltage .....	9.7 Volts
Heater Current .....	600 Ma
Heater Warm-up Time .....	11 Seconds
Maximum Heater-Cathode Voltage Heater Negative with Respect to Cathode Total DC and Peak .....	200 Volts
Heater Positive with Respect to Cathode DC .....	100 Volts
Total DC and Peak .....	200 Volts

**DIRECT INTERELECTRODE CAPACITANCES (Unshielded)**

	Section No. 1	Section No. 2
Grid to Plate .....	4.4	9.5 Pf
Input: g to (h + k) .....	2.2	7.0 Pf
Output: p to (h + k) .....	0.6	1.6 Pf

**RATINGS (Design Maximum Rating System)  
Vertical Deflection Oscillator and Amplifier<sup>(1)</sup>**

	Section No. 1 Oscillator	Section No. 2 Amplifier
Plate Voltage (Max.) .....	330	330 Volts
Peak Positive Pulse Plate Voltage (Max.) .....	—	1500 Volts
Peak Negative Pulse Grid Voltage (Max.) .....	400	250 Volts
Plate Dissipation (Max.) <sup>(2)</sup> .....	1.5	10 Watts
Average Cathode Current (Max.) .....	22	50 Ma
Peak Cathode Current (Max.) .....	77	175 Ma
Grid Circuit Resistance Self Bias (Max.) .....	2.2	2.2 Megohms

**CHARACTERISTICS AND TYPICAL OPERATION**

	Section No. 1 <sup>(3)</sup>	Section No. 2 <sup>(3)</sup>
Plate Voltage .....	250	150 Volts
Grid No. 1 Voltage .....	-11	-17.5 Volts
Plate Current .....	5.5	45 Ma
Transconductance .....	2000	7500 $\mu$ mhos
Amplification Factor .....	17.5	6.0
Plate Resistance (Approx.) .....	8750	800 Ohms
E <sub>c</sub> for I <sub>b</sub> = 10 $\mu$ a (Approx.) .....	-20	— Volts
E <sub>c</sub> for I <sub>b</sub> = 100 $\mu$ a (Approx.) .....	—	-40 Volts
I <sub>b</sub> at E <sub>c</sub> = -25 Vdc .....	—	8 Ma
I <sub>b</sub> with E <sub>b</sub> = 60 V and E <sub>c</sub> = 0 V .....	—	95 Ma

**NOTES:**

- (1) For operation in a 525 line, 30 frame system as described in "Standards of Good Engineering Practice for Television Broadcast Stations; Federal Communications Commission," the duty cycle of the voltage pulse must not exceed 15% of one horizontal scanning cycle.
- (2) In stages operating with grid leak bias, an adequate bias resistor or other suitable means is required to protect the tube in the absence of excitation.
- (3) Section No. 1 connects to Pins 4, 5 and 6. Section No. 2 connects to Pins 1, 2 and 3.

**SYNC SEPARATOR or  
VOLTAGE AMP. (T)  
VIDEO AMPLIFIER (P)**

**10JY8**

**Triode and Sharp Cutoff Pentode**

Construction ..... Miniature T-6½  
 Base ..... Button 9 Pin, E9-1  
 Basing ..... 9DX  
 Outline ..... 6-3  
 Maximum Diameter ..... 0.875 In.  
 Maximum Seated Height ..... 2.375 In.  
 Maximum Overall Height ..... 2.625 In.

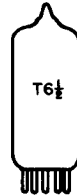
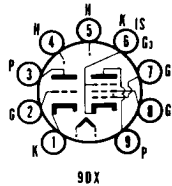

**ELECTRICAL DATA**

**HEATER OPERATION**

Heater Voltage.....	10.5 Volts
Heater Current .....	450 Ma
Heater Warm-up Time .....	11 Seconds
Maximum Heater-Cathode Voltage	
Heater Negative with Respect to Cathode	
Total DC and Peak.....	200 Volts
Heater Positive with Respect to Cathode	
DC .....	100 Volts
Total DC and Peak.....	200 Volts

**DIRECT INTERELECTRODE CAPACITANCES**

**Triode Section**

Grid to Plate .....	2.8 Pf
Input: g to (h + Tk + Pk + g3 + IS) .....	4.2 Pf
Output: p to (h + Tk + Pk + g3 + IS) .....	3.2 Pf

**Pentode Section**

Grid No. 1 to Plate .....	0.08 Pf
Input: g1 to (h + k + g2 + g3 + IS).....	10 Pf
Output: p to (h + k + g2 + g3 + IS).....	4.6 Pf

**RATINGS (Design Maximum Rating System)**

Plate Voltage (Max.) .....	330	330 Volts
Grid No. 2 Supply Voltage (Max.) .....	—	330 Volts
Grid No. 2 Voltage .....	See Rating Chart (Gen. Info. Sec.)	
Plate Dissipation (Max.) .....	2.0	5 Watts
Grid No. 2 Dissipation (Max.) .....	—	1.1 Watt
Positive Grid No. 1 Voltage (Max.) .....	0	0 Volt
Grid No. 1 Circuit Resistance		
Fixed Bias (Max.) .....	0.5	0.25 Megohm
Self Bias (Max.) .....	1.0	1.0 Megohm

**CHARACTERISTICS AND TYPICAL OPERATION**

**Class A1 Amplifier**

	<b>Triode Section</b>	<b>Pentode Section</b>
Plate Voltage .....	125	200 Volts
Grid No. 2 Voltage .....	—	150 Volts
Cathode Bias Resistor .....	68	100 Ohms
Plate Current .....	15	24 Ma
Grid No. 2 Current .....	—	4.8 Ma
Transconductance .....	10,400	11,000 μmhos
Amplification Factor .....	46	—
Plate Resistance (Approx.) .....	4400	55,000 Ohms
Ec1 for Ib = 10 μa (Approx.) .....	-8	-10 Volts

**INSTANTANEOUS PLATE KNEE CHARACTERISTICS**

Eb = 50 V; Ec2 = 150 V; and Ec1 = 0 V  
 Ib = 60 Ma (Approx.) and Ic2 = 18 Ma (Approx.)

**AVERAGE PLATE CHARACTERISTICS  
(Pentode Section)**

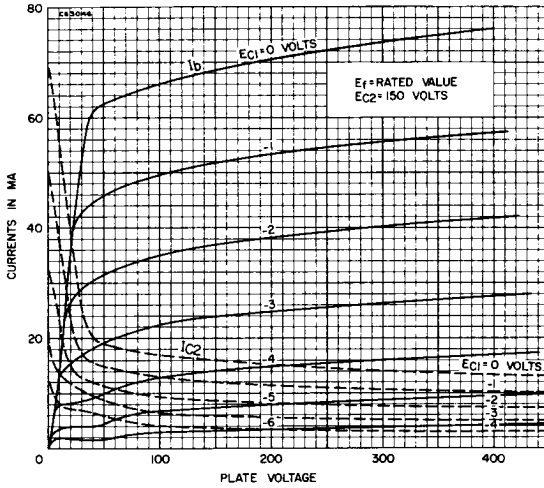

**AVERAGE PLATE CHARACTERISTICS  
(Triode Section)**

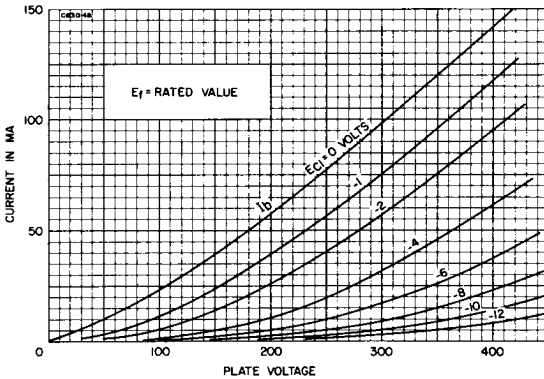

**10LW8**

**VIDEO AMPLIFIER (P)  
GENERAL PURPOSE (T)**

**High Mu Triode and  
Sharp Cutoff Pentode**

- Construction ..... Miniature T-6½
- Base ..... Button 9 Pin, E9-1
- Basing ..... .9DX
- Outline ..... 6-3
- Maximum Diameter ..... 0.875 In.
- Maximum Seated Height ..... 2.375 In.
- Maximum Overall Height ..... 2.625 In.

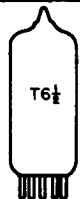
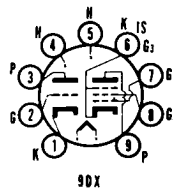



**ELECTRICAL DATA**

**HEATER OPERATION**

Heater Voltage .....	10.5 Volts
Heater Current .....	450 Ma
Heater Warm-up Time .....	11 Seconds
Maximum Heater-Cathode Voltage	
Heater Negative with Respect to Cathode	
Total DC and Peak .....	200 Volts
Heater Positive with Respect to Cathode	
DC .....	100 Volts
Total DC and Peak .....	200 Volts

**DIRECT INTERELECTRODE CAPACITANCES (Unshielded)**

**Pentode Section**

Grid No. 1 to Plate .....	0.08 Pf
Input: P <sub>g1</sub> to (h + P <sub>k</sub> + P <sub>g2</sub> + P <sub>g3</sub> + IS) .....	12 Pf
Output: P <sub>p</sub> to (h + P <sub>k</sub> + P <sub>g2</sub> + P <sub>g3</sub> + IS) .....	4.4 Pf

**Triode Section**

Grid to Plate .....	3.6 Pf
Input: T <sub>g</sub> to (h + T <sub>k</sub> + P <sub>k</sub> + P <sub>g3</sub> + IS) .....	2.8 Pf
Output: T <sub>p</sub> to (h + T <sub>k</sub> + P <sub>k</sub> + P <sub>g3</sub> + IS) .....	3.0 Pf

**RATINGS (Design Maximum Rating System)**

	Pentode Section	Triode Section
Plate Voltage (Max.) .....	330	330 Volts
Screen Supply Voltage (Max.) .....	330	— Volts
Screen Voltage .....	See Rating Chart (Gen. Info. Sec.)	
Positive DC Grid No. 1 Voltage (Max.) .....	0	0 Volt
Plate Dissipation (Max.) .....	4.0	1.5 Watts
Screen Dissipation (Max.) .....	1.5	— Watts
Grid No. 1 Circuit Resistance		
Fixed Bias (Max.) .....	0.5	0.5 Megohm
Cathode Bias (Max.) .....	1.0	1.0 Megohm

**CHARACTERISTICS AND TYPICAL OPERATION**

	Pentode Section	Triode Section
Plate Voltage .....	35	200 Volts
Screen Voltage .....	100	— Volts
Grid No. 1 Voltage .....	0	-2.0 Volts
Cathode-Bias Resistor .....	—	82 — Ohms
Amplification Factor .....	—	75
Plate Resistance (Approx.) .....	—	60,000
Transconductance .....	—	19,000
Plate Current .....	48	16.5
Screen Current .....	12.5	2.8
Grid Voltage (Approx.) I <sub>b</sub> = 30 μa .....	—	—
Grid No. 1 Voltage (Approx.) I <sub>b</sub> = 500 μa .....	—	-5.5

**VIDEO AMPLIFIER and  
GENERAL PURPOSE TRIODE**

**10LZ8**

**High Mu Triode and  
Sharp Cutoff Pentode**

Construction .....	Miniature T-6½
Base .....	Button 9 Pin, E9-1
Basing .....	9DX
Outline .....	6-3
Maximum Diameter .....	0.875 In.
Maximum Seated Height .....	2.375 In.
Maximum Overall Height .....	2.625 In.

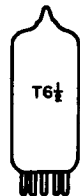
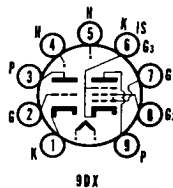

**ELECTRICAL DATA**

**HEATER OPERATION**

Heater Voltage .....	10.5 Volts
Heater Current .....	450 Ma
Heater Warm-up Time .....	11 Seconds
Maximum Heater-Cathode Voltage	
Heater Negative with Respect to Cathode	
Total DC and Peak .....	200 Volts
Heater Positive with Respect to Cathode	
DC .....	100 Volts
Total DC and Peak .....	200 Volts

**DIRECT INTERELECTRODE CAPACITANCES (Unshielded)**

**Pentode Section**

Grid No. 1 to Plate (Pg1 to Pp) .....	0.075 Pf
Input: P <sub>g1</sub> to (h + P <sub>k</sub> + P <sub>g2</sub> + P <sub>g3</sub> + IS) .....	9.5 Pf
Output: P <sub>p</sub> to (h + P <sub>k</sub> + P <sub>g2</sub> + P <sub>g3</sub> + IS) .....	4.4 Pf

**Triode Section**

Grid to Plate (T <sub>g</sub> to T <sub>p</sub> ) .....	3.8 Pf
Input: T <sub>g</sub> to (h + T <sub>k</sub> + P <sub>k</sub> + P <sub>g3</sub> + IS) .....	2.6 Pf
Output: T <sub>p</sub> to (h + T <sub>k</sub> + P <sub>k</sub> + P <sub>g3</sub> + IS) .....	3.0 Pf

**RATINGS (Design Maximum Rating System)**

	<b>Pentode Section</b>	<b>Triode Section</b>
Plate Voltage (Max.) .....	225	300 Volts
Screen Voltage (Max.) .....	160	— Volts
Positive DC Grid No. 1 Voltage (Max.) .....	0	0 Volt
Plate Dissipation (Max.) .....	4.5	1.0 Watts
Screen Dissipation (Max.) .....	2.0	— Watts
Grid No. 1 Circuit Resistance		
Fixed Bias (Max.) .....	0.5	0.5 Megohm
Cathode Bias (Max.) .....	1.0	1.0 Megohm

**CHARACTERISTICS AND TYPICAL OPERATION**

	<b>Pentode Section</b>			<b>Triode Section</b>
Plate Voltage .....	30	30	200	250 Volts
Screen Voltage .....	140	140	140	— Volts
Grid No. 1 Voltage .....	0	-1.0	-2.0	-2.0 Volts
Amplification Factor .....	—	—	—	110
Plate Resistance (Approx.) .....	—	—	150,000	52,000 Ohms
Transconductance .....	—	11,000	9500	2100 $\mu$ mhos
Plate Current .....	30	16	12	1.1 Ma
Screen Current .....	13.5	9.5	2.5	— Ma
Grid Voltage (Approx.) I <sub>b</sub> = 10 $\mu$ a .....	—	—	—	-3.6 Volts
Grid No. 1 Voltage (Approx.) I <sub>b</sub> = 500 $\mu$ a .....	—	-4	-4.2	— Volts



**Sharp Cutoff Pentode**

Construction .....	Miniature T-6 $\frac{1}{2}$
Base .....	Button 9 Pin, E9-1
Basing .....	.9BF
Outline .....	6-3
Maximum Diameter .....	0.875 In.
Maximum Seated Height .....	2.375 In.
Maximum Overall Height .....	2.625 In.

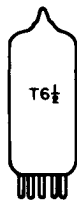
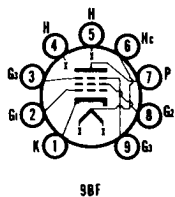

**ELECTRICAL DATA**

**HEATER OPERATION**

	<b>Series</b>	<b>Parallel</b>
Heater Voltage .....	11.0	5.5 Volts
Heater Current .....	300	600 Ma
Maximum Heater-Cathode Voltage		
Heater Negative with Respect to Cathode		
Total DC and Peak .....		200 Volts
Heater Positive with Respect to Cathode		
DC .....		100 Volts
Total DC and Peak .....		200 Volts

**DIRECT INTERELECTRODE CAPACITANCES (Unshielded)**

Grid No. 1 to Plate (Max.) .....	0.16 Pf
Input: g <sub>1</sub> to (k, g <sub>3</sub> + IS, g <sub>2</sub> , h) .....	14 Pf
Output: p to (k, g <sub>3</sub> + IS, g <sub>2</sub> , h) .....	5.0 Pf

**RATINGS (Design Maximum Rating System)**

**Class A1 Amplifier**

Plate Voltage (Max.) .....	330 Volts
Grid No. 2 Supply Voltage (Max.) .....	330 Volts
Grid No. 2 Voltage .....	See Rating Chart (Gen. Info. Sec.)
Grid No. 1 Voltage:	
Positive Bias Value (Max.) .....	0 Volt
Plate Dissipation (Max.) .....	7 Watts

Grid No. 2 Input:	
Ec2 up to 165 V (Max.)	1 Watt
Ec2 from 165 V to 330 V	See Rating Chart (Gen. Info. Sec.)
Grid No. 1 Circuit Resistance:	
Fixed Bias (Max.)	0.1 Megohm
Cathode Bias (Max.)	0.25 Megohm
<b>CHARACTERISTICS AND TYPICAL OPERATION</b>	
Plate Supply Voltage	200 Volts
Grid No. 3 Voltage	0 Volt
Grid No. 2 Supply Voltage	135 Volts
Grid No. 1 Supply Voltage	0 Volt
Cathode Resistor	47 Ohms
Plate Resistance (Approx.)	40 K Ohms
Transconductance	30,000 $\mu$ mhos
DC Plate Current	30 Ma
DC Grid No. 2 Current	5.2 Ma
Cutoff DC Grid No. 1 Voltage for $I_b = 100 \mu a$	-4.5 Volts

**AUDIO OUTPUT AMPLIFIER**

**12AB5**

**Beam Power Pentode**

Construction	Miniature T-6 $\frac{1}{2}$
Base	Button 9 Pin, E9-1
Basing	.9EU
Outline	6-3
Maximum Diameter	0.875 In.
Maximum Seated Height	2.375 In.
Maximum Overall Height	2.625 In.

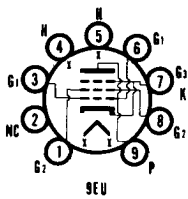

**ELECTRICAL DATA**

**HEATER OPERATION**

Heater Voltage <sup>(1)</sup>	12.6 Volts
Heater Current	200 Ma
Maximum Heater-Cathode Voltage	
Heater Negative with Respect to Cathode	
Total DC and Peak	200 Volts
Heater Positive with Respect to Cathode	
DC	100 Volts
Total DC and Peak	200 Volts

**DIRECT INTERELECTRODE CAPACITANCES (Unshielded)**

Grid to Plate	0.7 Pf
Input: g1 to (h + k + g2 + g3)	8.0 Pf
Output: p to (h + k + g2 + g3)	8.5 Pf

**RATINGS (Design Center Rating System)**

**Class A1 Amplifier**

Plate Voltage (Max.)	315 Volts
Plate Dissipation (Max.)	12 Watts
Grid No. 2 Voltage (Max.)	285 Volts
Grid No. 2 Dissipation (Max.)	2 Watts
Grid No. 1 Circuit Resistance	
Fixed Bias (Max.)	0.1 Megohm
Cathode Bias (Max.)	0.5 Megohm

**CHARACTERISTICS AND TYPICAL OPERATION**

**Class A1 Amplifier (Single Tube)**

Plate Voltage	180	250	250 Volts
Grid No. 2 Voltage	180	200	250 Volts
Grid No. 1 Voltage	-8.5	—	-12.5 Volts
Cathode Bias Resistor	—	270	— Ohms
Peak AF Grid No. 1 Voltage	8.5	10.5	12.5 Volts
Zero Signal Plate Current	29	33.5	45 Ma
Maximum Signal Plate Current	30	36.0	47 Ma
Zero Signal Grid No. 2 Current	3.0	1.6	4.5 Ma
Maximum Signal Grid No. 2 Current	4.0	3.2	7.0 Ma
Plate Resistance (Approx.)	50,000	—	50,000 Ohms
Transconductance	3700	4000	4100 $\mu$ mhos
Load Resistance	5500	6000	5000 Ohms
Maximum Signal Power Output	2.0	3.3	4.5 Watts
Total Harmonic Distortion	8	12	8 Percent

**Class A1 Push-Pull Amplifier (Values are for Two Tubes)**

Plate Voltage .....	250 Volts
Grid No. 2 Voltage .....	250 Volts
Grid No. 1 Voltage .....	-15 Volts
Peak AF Grid No. 1 Voltage .....	30 Volts
Zero Signal Plate Current .....	70 Ma
Maximum Signal Plate Current .....	79 Ma
Zero Signal Grid No. 2 Current .....	5 Ma
Maximum Signal Grid No. 2 Current .....	13 Ma
Plate to Plate Load Resistance .....	10,000 Ohms
Maximum Signal Power Output .....	10 Watts
Total Harmonic Distortion .....	5 Percent

**NOTE:**

(1) This tube is intended to be used in automotive service from a nominal 12 volt battery source. The heater is therefore designed to operate over the 10.0 to 15.9 voltage range encountered in this service. The maximum ratings of the tube provide for an adequate safety factor such that the tube will withstand the wide variation in supply voltages.

**12AD6**

**OSCILLATOR and MIXER**

**Pentagrid Converter**

Construction .....	Miniature T-5½
Base .....	Button 7 Pin, E7-1
Basing .....	.7CH
Outline .....	5-2
Maximum Diameter .....	0.750 In.
Maximum Seated Height .....	1.875 In.
Maximum Overall Height .....	2.125 In.

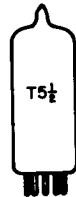
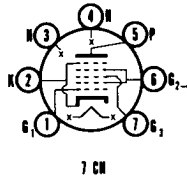

**ELECTRICAL DATA**

**HEATER OPERATION**

Heater Voltage <sup>(1)</sup> .....	12.6 Volts
Heater Current .....	150 Ma
Maximum Heater-Cathode Voltage .....	30 Volts
Heater Negative with Respect to Cathode .....	30 Volts
Heater Positive with Respect to Cathode .....	30 Volts

**DIRECT INTERELECTRODE CAPACITANCES**

	Shielded <sup>(2)</sup>	Unshielded
Grid No. 3 to Plate (Max.) .....	0.26	0.30 Pf
Grid No. 3 to Grid No. 1 (Max.) .....	0.15	0.15 Pf
RF Input: g3 to (h + k + g1 + g2 and g4 + g5 + p) .....	7.0	7.0 Pf
Oscillator Input: g1 to (h + k + g1 + g2 and g4 + g3 + g5) .....	3.2	3.2 Pf
Mixer Output: p to (h + k + g1 + g2 and g4 + g3 + g5) .....	12.0	7.0 Pf
Oscillator Output: k to (h + g2 and g4 + g3 + p) .....	11	11 Pf
Oscillator Grid No. 1 to Plate (Max.) .....	2.2	2.2 Pf

**RATINGS (Design Center Rating System)**

Plate Voltage (Max.) .....	16 Volts
Grid No. 2 and No. 4 Voltage (Max.) .....	16 Volts
Grid No. 2 and No. 4 Supply Voltage (Max.) .....	16 Volts
Negative DC Grid No. 3 Voltage (Max.) .....	16 Volts
Positive DC Grid No. 3 Voltage (Max.) .....	0 Volt
Cathode Current (Max.) .....	20 Ma
Grid No. 3 Circuit Resistance (Max.) .....	10 Megohms

**CHARACTERISTICS AND TYPICAL OPERATION**

**Converter—Self Excitation**

Plate Voltage .....	12.6 Volts
Grid No. 2 and 4 Voltage .....	12.6 Volts
Grid No. 3 Voltage <sup>(3)</sup> .....	0 Volt
Grid No. 3 Resistor .....	2.2 Megohms
Plate Voltage .....	350 μa
Grid No. 1 Resistor (Oscillator Grid) .....	33,000 Ohms
Grid No. 1 Voltage (Oscillator Grid) Pk to Pk .....	4.5 Volts
Grid No. 1 Current (Oscillator Grid) .....	60 μa
Conversion Transconductance .....	320 μmhos
Plate Resistance (Approx.) .....	0.4 Megohm
Cathode Current .....	1600 μa
Grid No. 3 Voltage for Gc = 5 μmhos (Approx.) .....	-3 Volts
Grid No. 3 Voltage for Gc = 0.5 μmhos (Approx.) .....	-4 Volts

**Oscillator—Not Oscillating**

Plate Voltage .....	12.6 Volts
Grid No. 2 and 4 Voltage.....	12.6 Volts
Grid No. 3 Voltage .....	0 Volt
Grid No. 1 Voltage .....	0 Volt
Transconductance .....	3600 $\mu$ mhos
Amplification Factor .....	9.4
Cathode Current .....	4.5 Ma
Grid No. 1 Voltage for $I_b = 10 \mu$ a (Approx.) .....	-3.7 Volts

**NOTES:**

- (1) This tube is intended for use in automobile radios operated from a nominal 12 volt battery. Design of the tube is such that the heater will operate satisfactorily over the range 10.0 volts to 15.9 volts, and that the maximum ratings provide a safety factor for the wide voltage variation encountered with the type of supply.
- (2) External shield No. 316 connected to Pin 2.
- (3) Average contact potential is developed across the specified grid resistor.
- (4) Connected to plate.

**DETECTOR and AF AMPLIFIER**

**12AE6A**

**Double Diode and Medium Mu Triode**

Construction .....	Miniature T-5½
Base .....	Button 7 Pin, E7-1
Basing .....	.7BT
Outline .....	5-2
Maximum Diameter .....	0.750 In.
Maximum Seated Height .....	1.875 In.
Maximum Overall Height .....	2.125 In.

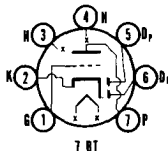

**ELECTRICAL DATA**

**HEATER OPERATION**

Heater Voltage <sup>(1)</sup> .....	12.6 Volts
Heater Current .....	150 Ma
Maximum Heater-Cathode Voltage	
Heater Negative with Respect to Cathode .....	30 Volts
Heater Positive with Respect to Cathode .....	30 Volts

**DIRECT INTERELECTRODE CAPACITANCES (Unshielded)**

Grid to Plate .....	2.0 Pf
Input .....	1.8 Pf
Output .....	1.1 Pf
Diode to Diode.....	0.9 Pf

**RATINGS (Design Center Rating System)**

**Class A1 Amplifier**

Plate Voltage (Max.) .....	30 Volts
Cathode Current (Max.).....	20 Ma
Grid Circuit Resistance (Max.) .....	10 Megohms

**Diode Section**

Average Diode Current (Max.) .....	1 Ma
------------------------------------	------

**CHARACTERISTICS AND TYPICAL OPERATION**

**Class A1 Amplifier**

**Triode Section**

Plate Voltage .....	12.6	12.6 Volts
Grid Voltage .....	0	— Volt
Grid Resistor .....	0	10 Megohms
Plate Current .....	1.0	0.32 Ma
Transconductance.....	1300	715 $\mu$ mhos
Plate Resistance.....	13	20 K Ohms
Amplification Factor .....	16.7	14.3

**Diode Section**

Average Diode Current with 10 Volts Applied (Each Diode) .....	2.0 Ma
--	--------

**NOTE:**

- (1) This tube is intended for use in automobile radios operated from a nominal 12 Volt battery. Design of the tube is such that the heater will operate satisfactorily over the range 10.0 volts to 15.9 volts, and that the maximum ratings provide a safety factor for the wide voltage variation encountered with this type of supply.

# 12AF6

# RF/IF AMPLIFIER

**Remote Cutoff Pentode**

Construction ..... Miniature T-5½  
 Base ..... Button 7 Pin, E7-1  
 Basing ..... 7BK  
 Outline ..... 5-2  
 Maximum Diameter ..... 0.750 In.  
 Maximum Seated Height ..... 1.875 In.  
 Maximum Overall Height ..... 2.125 In.

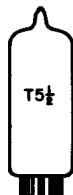
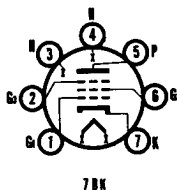

**ELECTRICAL DATA**  
**HEATER OPERATION**

Heater Voltage <sup>(1)</sup> .....	12.6 Volts
Heater Current .....	150 Ma
Maximum Heater-Cathode Voltage	
Heater Negative with Respect to Cathode .....	16 Volts
Heater Positive with Respect to Cathode .....	16 Volts

**DIRECT INTERELECTRODE CAPACITANCES (Unshielded)**

Grid to Plate .....	0.006 Pf
Input .....	5.5 Pf
Output .....	4.8 Pf

**RATINGS (Design Maximum Rating System)**

Plate Voltage (Max.) .....	16 Volts
Grid No. 2 Voltage (Max.) .....	16 Volts
Positive DC Grid No. 1 Voltage (Max.) .....	0 Volt
Grid No. 1 Circuit Resistance (Max.) .....	2.2 Megohms

**CHARACTERISTICS AND TYPICAL OPERATION**

Plate Voltage .....	12.6 Volts
Grid No. 3 Voltage .....	0 Volt
Grid No. 2 Voltage .....	12.6 Volts
Grid No. 1 Supply Voltage.....	0 Volt
Plate Current .....	1.1 Ma
Grid No. 2 Current .....	0.45 Ma
Transconductance .....	1500 μmhos
Plate Resistance (Approx.) .....	0.35 Megohm
Grid No. 1 Resistor (Bypassed) .....	2.2 Megohm
Grid No. 1 Voltage <sup>(2)</sup> (Approx.) for Gm = 10 μmhos.....	-3.5 Volts

**NOTES:**

- (1) This tube is intended for use in automobile radios operated from a nominal 12 volt battery. Design of the tube is such that the heater will operate satisfactorily over the range 10.0 volts to 15.9 volts, and that the maximum ratings provide a safety factor for the wide voltage variation encountered with this type of supply.
- (2) Grid No. 1 tied to Grid No. 3.

# 12AT7/ECC81

Color Television Type  
**GROUNDING GRID AMPLIFIER**

**Double High Mu Triode**

Construction ..... Miniature T-6½  
 Base ..... Button 9 Pin, E9-1  
 Basing ..... 9A  
 Outline ..... 6-2  
 Maximum Diameter ..... 0.875 In.  
 Maximum Seated Height ..... 1.937 In.  
 Maximum Overall Height ..... 2.187 In.

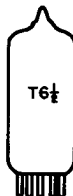
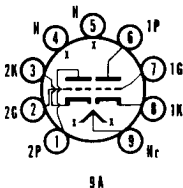

**ELECTRICAL DATA**  
**HEATER OPERATION**

Heater Voltage.....	12.6/6.3 Volts
Heater Current .....	150/300 Ma
Maximum Heater-Cathode Voltage .....	90 Volts

**DIRECT INTERELECTRODE CAPACITANCES (Unshielded)**

	Section 1	Section 2
Grid to Plate .....	1.5	1.5 Pf
Input .....	2.2	2.2 Pf
Output .....	0.5	0.4 Pf
Grid to Grid (Max.) .....		.005 Pf
Plate to Plate (Max.) .....		0.4 Pf
Heater to Cathode .....	2.4	2.4 Pf
<b>Grounded Grid Section</b>		
Plate to Cathode .....	0.2	0.2 Pf
Input .....	4.6	4.6 Pf
Output .....	1.8	1.8 Pf

**RATINGS (Design Center Rating System) (Each Section)**

Plate Voltage (Max.) .....	300 Volts
Plate Dissipation (Max.) .....	2.5 Watts

**CHARACTERISTICS AND TYPICAL OPERATION**

**Class A1 Amplifier (Each Section)**

Grid Voltage .....	100	180	250 Volts
Grid Voltage .....	-1	-1	-2 Volts
Cathode Bias Resistor .....	270	90	200 Ohms
Plate Current .....	3.7	11.0	10.0 Ma
Plate Resistance .....	15,000	9400	10,900 Ohms
Transconductance .....	4000	6000	5500 $\mu$ hos
Amplification Factor .....	60	62	60
Ec for Ib = 10 $\mu$ a (Approx.) .....	-5	-8	-12 Volts

**AVERAGE PLATE CHARACTERISTICS**

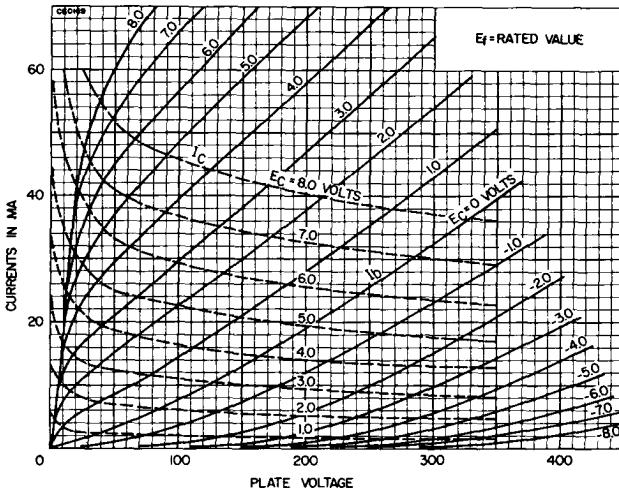

**AVERAGE TRANSFER CHARACTERISTICS**

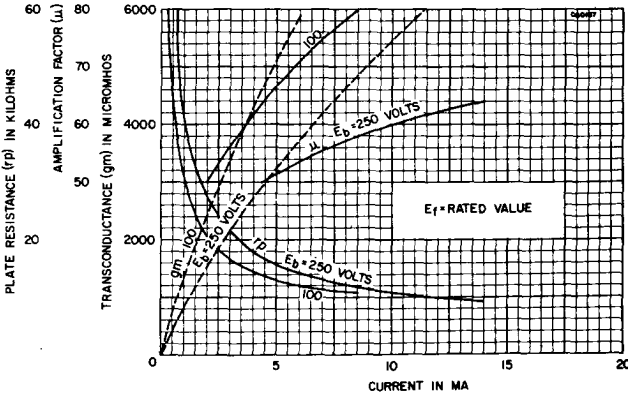

# 12AU7A/ECC82

7AU7, 9AU7

Color Television Type

## VERTICAL or HORIZ. DEFLECTION OSCILLATOR and AMPLIFIER

### Double Medium Mu Triode

Construction ..... Miniature T-6½  
 Base ..... Button 9 Pin, E9-1  
 Basing<sup>(2)</sup> ..... 9A  
 Outline ..... 6-2  
 Maximum Diameter ..... 0.875 In.  
 Maximum Seated Height ..... 1.937 In.  
 Maximum Overall Height ..... 2.187 In.

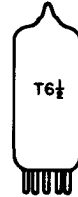
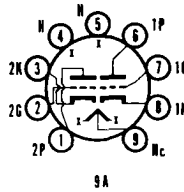

### ELECTRICAL DATA

#### HEATER OPERATION

	7AU7	9AU7	12AU7/ECC82
Heater Voltage.....	7.0/3.5	9.4/4.7	12.6/6.3 Volts
Heater Current.....	300/600	450/225	150/300 Ma
Heater Warm-up Time .....	11	11	— Seconds
Maximum Heater-Cathode Voltage			
Heater Negative with Respect to Cathode			
Total DC and Peak.....			200 Volts
Heater Positive with Respect to Cathode			
DC .....			100 Volts
Total DC and Peak.....			200 Volts

#### DIRECT INTERELECTRODE CAPACITANCES

	Shielded <sup>(1)</sup>	Unshielded
Grid to Plate: Section 1 .....	1.5	1.5 Pf
Section 2 .....	1.5	1.5 Pf
Input: g to (h + k) Section 1 and 2 .....	1.8	1.6 Pf
Output: p to (h + k) Section 1 .....	2.0	0.40 Pf
Section 2 .....	2.0	0.32 Pf

#### RATINGS (Design Maximum Rating System) (Each Section)

	Class A1 Amplifier	Vertical <sup>(3)</sup> Deflection Amplifier
Plate Voltage (Max.) .....	330	330 Volts
Peak Positive Plate Voltage (Abs. Max.) .....	—	1200 Volts
Plate Dissipation <sup>(4)</sup> Each Plate (Max.) .....	2.75	2.75 Watts
Both Plates (Max.) .....	5.5	5.5 Watts
Peak Negative Grid Voltage (Max.) .....	—	275 Volts
Average Cathode Current (Max.).....	22	22 Ma
Peak Cathode Current (Max.) .....	—	66 Ma
Grid Circuit Resistance		
Fixed Bias (Max.) .....	0.25	— Megohm
Cathode Bias (Max.) .....	1.0	2.2 Megohms

#### RATINGS (Design Center Rating System)

	Vertical <sup>(3)</sup> Deflection Oscillator	Horizontal <sup>(3)</sup> Deflection Oscillator
Plate Voltage (Max.) .....	330	330 Volts
Plate Dissipation <sup>(4)</sup>		
Each Plate (Max.).....	2.75	2.75 Watts
Both Plates (Max.).....	5.5	5.5 Watts
Peak Negative Grid Voltage (Max.) .....	440	660 Volts
Average Cathode Current (Max.).....	22	22 Ma
Peak Cathode Current (Max.) .....	66	330 Ma
Grid Circuit Resistance (Max.).....	2.2	2.2 Megohms

### CHARACTERISTICS AND TYPICAL OPERATION

#### Class A1 Amplifier (Each Section)

	Vertical <sup>(3)</sup> Deflection Oscillator	Horizontal <sup>(3)</sup> Deflection Oscillator
Plate Voltage .....	100	250 Volts
Grid Voltage .....	0	-8.5 Volts
Plate Current .....	11.8	10.5 Ma
Plate Resistance (Approx.) .....	6500	7700 Ohms
Transconductance .....	3100	2200 μmhos
Amplification Factor .....	20	17
Grid Voltage for Ib = 10 μa (Approx.) .....	—	-24 Volts



**NOTES:**

- (1) External shield No. 315 connected to cathode of section under test.
- (2) Section No. 1 connects to pins 6, 7, and 8. Section No. 2 connects to pins 1, 2, and 3.
- (3) For operation in a 525 line, 30 frame system as described in "Standards of Good Engineering Practice for Television Broadcast Stations; Federal Communications Commission," the duty cycle of the voltage pulse must not exceed 15% of one horizontal scanning cycle.
- (4) In stages operating with grid leak bias, an adequate cathode bias resistor or other suitable means is required to protect the tube in the absence of excitation.

**AVERAGE PLATE CHARACTERISTICS**

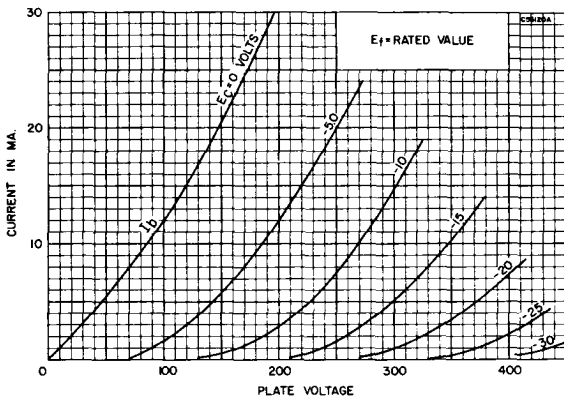

**AVERAGE TRANSFER CHARACTERISTICS**

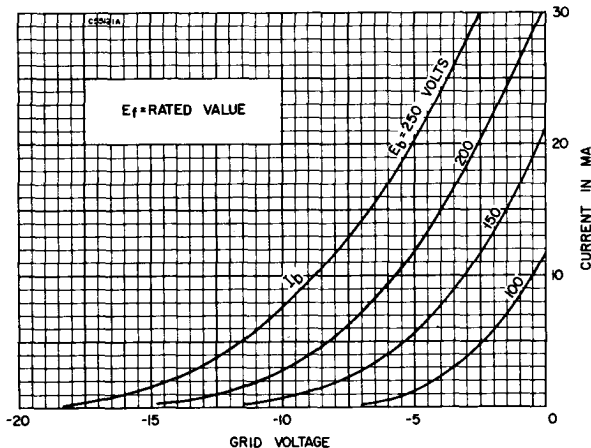

Color Television Type

**GROUNDING GRID AMPLIFIER**

**12AV7**

**Double Medium Mu Triode**

- Construction ..... Miniature T-6½
- Base ..... Button 9 Pin, E9-1
- Basing<sup>(2)</sup> ..... 9A
- Outline ..... 6-2
- Maximum Diameter ..... 0.875 In.
- Maximum Seated Height ..... 1.937 In.
- Maximum Overall Height ..... 2.187 In.

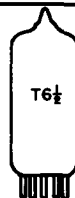
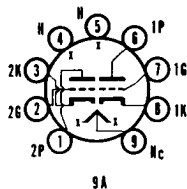

**ELECTRICAL DATA**

**HEATER OPERATION**

Heater Voltage.....	12.6/6.3 Volts
Heater Current.....	225/450 Ma
Maximum Heater-Cathode Voltage.....	90 Volts

**DIRECT INTERELECTRODE CAPACITANCES**

	Shielded <sup>(1)</sup>	Unshielded
Grid to Plate (Each Section).....	1.9	1.9 Pf
Input (Each Section).....	3.2	3.1 Pf
Output (Section 1).....	1.3	0.5 Pf
(Section 2).....	1.6	0.4 Pf
Heater to Cathode (Each Section).....	4.0	3.8 Pf

**Grounded Grid Operation**

Input (Each Section).....	7.0	6.9 Pf
Output (Section 1).....	2.8	2.0 Pf
(Section 2).....	3.2	2.0 Pf
Plate to Cathode (Each Section).....	0.23	0.24 Pf

**RATINGS (Design Center Rating System) (Each Section)**

Plate Voltage (Max.).....	300 Volts
Plate Dissipation (Max.).....	2.7 Watts
Negative Grid Voltage (Max.).....	50 Volts

**CHARACTERISTICS AND TYPICAL OPERATION**

**Class A1 Amplifier (Each Section)**

Plate Voltage.....	100	150 Volts
Cathode Bias Resistor.....	120	56 Ohms
Plate Current.....	9.0	18 Ma
Transconductance.....	6100	8500 $\mu$ mhos
Amplification Factor.....	37	41
Plate Resistance.....	6100	4800 Ohms
Grid Voltage for $I_b = 10 \mu$ a.....	-9	-12 Volts

**NOTES:**

- (1) Shield No. 315 connected to cathode.
- (2) Section 1 connects to Pins 6, 7, and 8. Section 2 connects to Pins 1, 2, and 3.

# 12AX7A/ECC83

6AX7

*Color Television Type*

## AF AMPLIFIER or PHASE INVERTER

**Double High Mu Triode**

Construction.....	Miniature T-6 $\frac{1}{2}$
Base.....	Button 9 Pin, E9-1
Basing <sup>(1)</sup> .....	.9A
Outline.....	6-2
Maximum Diameter.....	0.875 In.
Maximum Seated Height.....	1.937 In.
Maximum Overall Height.....	2.187 In.

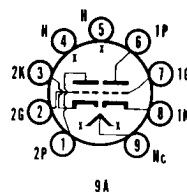

**ELECTRICAL DATA**

**HEATER OPERATION**

	6AX7	12AX7/ECC83
Heater Voltage.....	6.3/3.15	12.6/6.3 Volts
Heater Current.....	300/600	150/300 Ma
Heater Warm-up Time <sup>(2)</sup> .....	11	— Seconds
Maximum Heater-Cathode Voltage		
Heater Negative with Respect to Cathode		
Total DC and Peak.....		200 Volts
Heater Positive with Respect to Cathode		
DC.....		100 Volts
Total DC and Peak.....		200 Volts

**DIRECT INTERELECTRODE CAPACITANCES**

	Section 1 <sup>(1)</sup>		Section 2 <sup>(1)</sup>	
	Shielded	Unshielded	Shielded <sup>(2)</sup>	Unshielded
Grid to Plate.....	1.7	1.7	1.7	1.7 Pf
Input (g to h + k).....	1.8	1.6	1.8	1.6 Pf
Output (p to h + k).....	1.9	0.46	1.9	0.34 Pf

**RATINGS (Design Maximum Rating System) (Each Section)**

Plate Voltage (Max.).....	330 Volts
Plate Dissipation (Max.).....	1.0 Watt
Positive DC Grid Voltage (Max.).....	0 Volt
Negative DC Grid Voltage (Max.).....	-55 Volts

**CHARACTERISTICS AND TYPICAL OPERATION**  
**Class A1 Amplifier (Each Section)**

Plate Voltage .....	100	250 Volts
Grid Voltage .....	-1	-2 Volts
Plate Current .....	0.5	1.2 Ma
Plate Resistance.....	80,000	62,500 Ohms
Transconductance .....	1250	1600 $\mu$ mhos
Amplification Factor .....	100	100

**NOTES:**

- (1) Section No. 1 connects to Pins 6, 7, and 8. Section No. 2 connects to Pins 1, 2, and 3.
- (2) External Shield No. 315 connected to cathode of section under test.
- (3) Controlled Heater Warm-up Time applies to parallel connection only.

Color Television Type  
**GROUNDING GRID AMPLIFIER**

**12AZ7A**

**Double High Mu Triode**

Construction .....	Miniature T-6½
Base .....	Button 9 Pin, E9-1
Basing .....	.9A
Outline .....	6-2
Maximum Diameter .....	0.875 In.
Maximum Seated Height .....	1.937 In.
Maximum Overall Height .....	2.187 In.

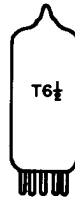
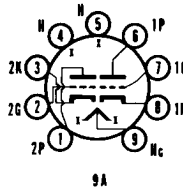

**ELECTRICAL DATA**

**HEATER OPERATION**

Heater Voltage.....	12.6/6.3 Volts
Heater Current .....	225/450 Ma
Heater Warm-up Time .....	11 Seconds
Maximum Heater-Cathode Voltage .....	90 Volts

**DIRECT INTERELECTRODE CAPACITANCES**

	Shielded	Unshielded
Grid to Plate (Each Section) .....	1.9	1.9 Pf
Input (Each Section) .....	3.2	3.1 Pf
Output (Section 1) <sup>(2)</sup> .....	1.3	0.5 Pf
Output (Section 2) .....	1.6	0.4 Pf

**Grounded Grid Operation**

Input (Each Section) .....	7.0	6.9 Pf
Output (Section 1) <sup>(2)</sup> .....	2.8	2.0 Pf
(Section 2) .....	3.2	2.0 Pf
Plate to Cathode .....	0.23	0.24 Pf

**RATINGS (Design Center Rating System)**

Plate Voltage (Max.) .....	300 Volts
Plate Dissipation (Max.) .....	2.5 Watts
Negative Grid Voltage (Max.) .....	50 Volts
Grid Circuit Resistance	
Fixed Bias (Max.) .....	0.25 Megohm
Self Bias (Max.) .....	1.0 Megohm

**CHARACTERISTICS AND TYPICAL OPERATION**  
**Class A1 Amplifier (Each Section)**

Plate Voltage .....	100	250 Volts
Cathode Bias Resistor .....	270	200 Ohms
Plate Current .....	3.7	10 Ma
Transconductance .....	4000	5500 $\mu$ mhos
Amplification Factor .....	60	60
Plate Resistance.....	15,000	10,900 Ohms
E <sub>c1</sub> for I <sub>b</sub> = 10 $\mu$ a (Approx.).....	-5	-12 Volts

**NOTES:**

- (1) Shield No. 315.
- (2) Section 1 connects to pins 6, 7, and 8.

# 12BH7A

## Color Television Type VERTICAL or HORIZ. DEFLECTION OSCILLATOR and AMPLIFIER

### Double Low Mu Triode

Construction ..... Miniature T-6½  
 Base ..... Button 9 Pin, E9-1  
 Basing<sup>(2)</sup> ..... 9A  
 Outline ..... 6-3  
 Maximum Diameter ..... 0.875 In.  
 Maximum Seated Height ..... 2.375 In.  
 Maximum Overall Height ..... 2.625 In.

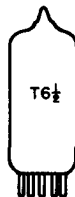
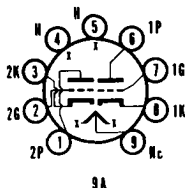

### ELECTRICAL DATA

#### HEATER OPERATION

Heater Voltage.....	12.6/6.3 Volts
Heater Current.....	300/600 Ma
Heater Warm-up Time <sup>(1)</sup> .....	11 Seconds
Maximum Heater-Cathode Voltage	
Heater Negative with Respect to Cathode	
Total DC and Peak.....	200 Volts
Heater Positive with Respect to Cathode	
DC.....	100 Volts
Total DC and Peak.....	200 Volts

#### DIRECT INTERELECTRODE CAPACITANCES (Unshielded)

	Section 1 <sup>(2)</sup>	Section 2
Grid to Plate.....	2.6	2.6 Pf
Input.....	3.2	3.2 Pf
Output.....	0.5	0.4 Pf
Plate to Plate.....		Pf
		0.8

#### RATINGS (Design Center Rating System)

	Vertical Deflection Amplifier	Class A1 Amplifier
Plate Voltage (Max.).....	450	300 Volts
Peak Positive Plate Voltage (Abs. Max.).....	1500	— Volts
Plate Dissipation (Each Plate) (Max.).....	3.5	3.5 Watts
Peak Negative Pulse Grid Voltage (Max.).....	250	— Volts
Average Cathode Current (Each Section).....	20	20 Ma
Peak Cathode Current (Max.).....	70	— Ma
Grid Circuit Resistance		
Fixed Bias (Max.).....	—	0.25 Megohm
Cathode Bias (Max.).....	2.2	1.0 Megohms

	Vertical <sup>(2)</sup> Deflection Oscillator	Horizontal <sup>(2)</sup> Deflection Oscillator
DC Plate Voltage (Max.).....	450	450 Volts
Plate Dissipation		
Each Plate (Max.).....	3.5	3.5 Watts
Both Plates (Max.).....	7.0	7.0 Watts
Peak Negative Grid Voltage (Max.).....	400	600 Volts
Average Cathode Current (Max.).....	20	20 Ma
Peak Cathode Current (Max.).....	70	300 Ma
Grid Circuit Resistance (Max.).....	2.2	2.2 Megohms

### CHARACTERISTICS AND TYPICAL OPERATION

#### Class A1 Amplifier

Plate Voltage.....	250 Volts
Grid Voltage.....	-10.5 Volts
Plate Current.....	11.5 Ma
Transconductance.....	3100 μmhos
Amplification Factor.....	16.5
Grid Voltage for Ib = 50 μa.....	-23 Volts
Plate Resistance (Approx.).....	5300 Ohms

### NOTES:

- (1) Applies to parallel connection only.
- (2) Section 1 connects to pins 6, 7, and 8.
- (3) For operation in a 525 line, 30 frame system as described in "Standards of Good Engineering Practice for Television Broadcast Stations; Federal Communications Commission," the duty cycle of the voltage pulse must not exceed 15% of one horizontal scanning cycle.

**AVERAGE PLATE CHARACTERISTICS**

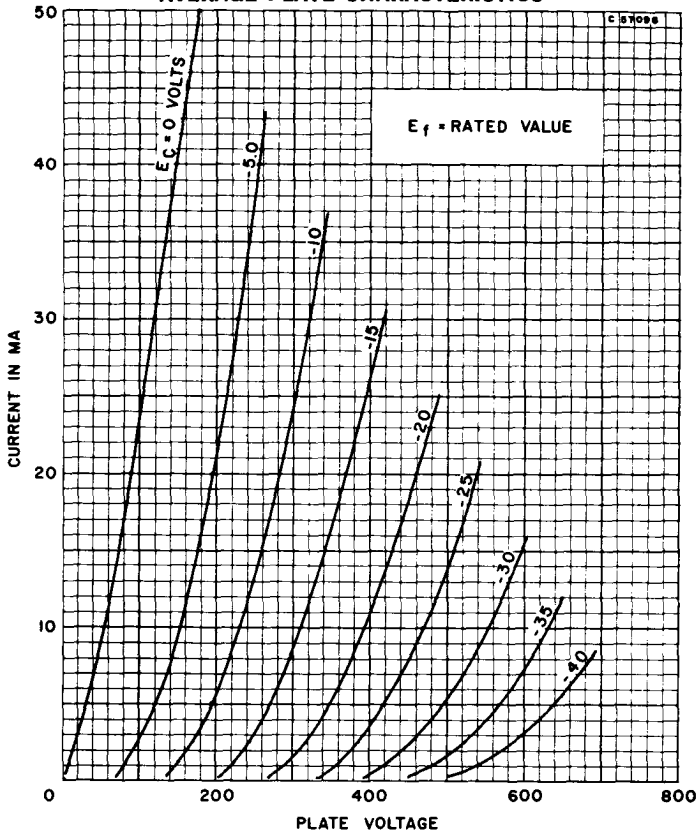

**RF/IF AMPLIFIER**

**12BL6**

**Semi-Remote Cutoff Pentode**

- Construction ..... Miniature T-5½
- Base ..... Button 7 Pin, E7-1
- Basing ..... 7BK
- Outline ..... 5-2
- Maximum Diameter ..... 0.750 In.
- Maximum Seated Height ..... 1.875 In.
- Maximum Overall Height ..... 2.125 In.

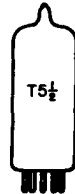
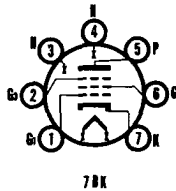

**ELECTRICAL DATA**

<b>HEATER OPERATION</b>	
Heater Voltage <sup>(1)</sup> .....	12.6 Volts
Heater Current .....	150 Ma
Maximum Heater-Cathode Voltage	
Heater Negative with Respect to Cathode .....	30 Volts
Heater Positive with Respect to Cathode .....	30 Volts
<b>DIRECT INTERELECTRODE CAPACITANCES (Shielded)</b>	
Grid No. 1 to Plate (Max.).....	0.006 Pf
Input .....	5.5 Pf
Output .....	4.8 Pf

**RATINGS (Design Center Rating System)**

Plate Voltage (Max.) .....	30 Volts
Grid No. 2 Voltage (Max.) .....	30 Volts
Cathode Current (Max.) .....	20 Ma
Grid No. 1 Circuit Resistance (Max.) .....	10 Megohms

**CHARACTERISTICS AND TYPICAL OPERATION**

Plate Voltage .....	12.6 Volts
Grid No. 3 Voltage <sup>(2)</sup> .....	0 Volt
Grid No. 2 Voltage .....	12.6 Volts
Grid No. 1 Voltage <sup>(3)</sup> .....	-0.65 Volts
Plate Current .....	1350 $\mu$ a
Grid No. 2 Current .....	500 $\mu$ a
Transconductance <sup>(4)</sup> .....	1350 $\mu$ mhos
Plate Resistance (Approx.) .....	0.5 Megohm
Grid No. 1 Voltage for Gm = 10 $\mu$ mhos (Approx.) .....	-6.0 Volts
Grid No. 1 and No. 3 Voltage for Gm = 10 $\mu$ mhos (Approx.) .....	-5.0 Volts

**NOTES:**

- (1) This tube is intended for use in automobile radios operated from a nominal 12-volt battery. Design of the tube is such that the heater will operate satisfactorily over the range 10.0 volts to 15.9 volts, and the maximum ratings provide a safety factor for the wide voltage variation encountered with this type of supply.
- (2) Connected to Cathode at socket.
- (3) Average contact potential bias developed across a 2.2 megohm grid resistor.
- (4) From Grid No. 1 to plate.



**Double Diode and High Mu Triode**

Construction .....	Miniature T-6½
Base .....	Button 9 Pin, E9-1
Basing .....	9CF
Outline .....	6-2
Maximum Diameter .....	0.875 In.
Maximum Seated Height .....	1.937 In.
Maximum Overall Height .....	2.187 In.

**ELECTRICAL DATA  
HEATER OPERATION**

Heater Voltage .....	<b>9BR7</b> 9.4/4.7	<b>12BR7</b> 12.6/6.3 Volts
Heater Current .....	300/600	225/450 Ma
Heater Warm-up Time .....	11	— Seconds
Maximum Heater-Cathode Voltage		
Heater Negative with Respect to Cathode		
Total DC and Peak .....		200 Volts
Heater Positive with Respect to Cathode		
DC .....		100 Volts
Total DC and Peak .....		200 Volts

**DIRECT INTERELECTRODE CAPACITANCES (Shielded)<sup>(1)</sup>**

Triode Grid to Plate .....	1.9 Pf
Triode Input .....	2.8 Pf
Triode Output .....	1.0 Pf
Diode Input (Each Diode) .....	2.0 Pf

**RATINGS (Design Center Rating System)**

Plate Voltage (Triode) (Max.) .....	300 Volts
Plate Dissipation (Triode) (Max.) .....	2.5 Watts
Peak Inverse Diode Voltage (Max.) .....	300 Volts
Peak Diode Current (Max.) .....	60 Ma

**CHARACTERISTICS AND TYPICAL OPERATION**

**Class A1 Amplifier**

Plate Voltage .....	100	250 Volts
Cathode Bias Resistor .....	270	200 Ohms
Amplification Factor .....	60	60
Plate Resistance (Approx.) .....	15,000	10,900 Ohms
Transconductance .....	4000	5500 $\mu$ mhos
Plate Current .....	3.7	10 Ma
Grid Voltage (Approx.) for Ib = 10 $\mu$ a .....	-5	-12 Volts
Average Diode Current		
Each Diode with 5.0 volts DC applied .....	—	17 Ma

**NOTE:**

- (1) Shield No. 315.

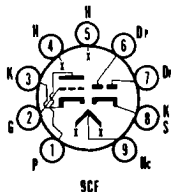

Color Television Type  
**VIDEO AMPLIFIER**

**12BY7A**

**High Transconductance Pentode**

Construction ..... Miniature T-6½  
 Base ..... Button 9 Pin, E9-1  
 Basing ..... 9BF  
 Outline ..... 6-3  
 Maximum Diameter ..... 0.875 In.  
 Maximum Seated Height ..... 2.375 In.  
 Maximum Overall Height ..... 2.625 In.

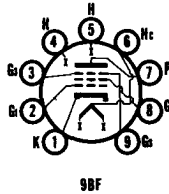

**ELECTRICAL DATA**

**HEATER OPERATION**

Heater Voltage.....	12.6/6.3 Volts
Heater Current.....	300/600 Ma
Heater Warm-up Time <sup>(1)</sup> .....	11 Seconds
Maximum Heater-Cathode Voltage	
Heater Negative with Respect to Cathode	
Total DC and Peak.....	200 Volts
Heater Positive with Respect to Cathode	
DC.....	100 Volts
Total DC and Peak.....	200 Volts

**DIRECT INTERELECTRODE CAPACITANCES (Unshielded)**

Grid No. 1 to Plate.....	0.063 Pf
Input.....	10.2 Pf
Output.....	3.5 Pf

**RATINGS (Design Center Rating System)**

Plate Voltage (Max.).....	300 Volts
Plate Dissipation (Max.).....	6.5 Watts
Grid No. 2 Voltage (Max.).....	180 Volts
Grid No. 2 Dissipation (Max.).....	1.1 Watts
Grid No. 1 Voltage	
Negative (Max.).....	50 Volts
Positive (Max.).....	0 Volt
Grid No. 1 Resistance	
Fixed Bias (Max.).....	0.25 Megohm
Cathode Bias (Max.).....	1.0 Megohm

**CHARACTERISTICS AND TYPICAL OPERATION**

**Class A1 Amplifier**

Plate Voltage.....	250 Volts
Grid No. 2 Voltage.....	180 Volts
Cathode Bias Resistor.....	100 Ohms
Plate Current.....	26 Ma
Grid No. 2 Current.....	5.75 Ma
Transconductance.....	11,000 μmhos
Plate Resistance.....	93,000 Ohms
Amplification Factor.....	1035
Grid No. 1 Voltage for Ib = 20 μa.....	-11.6 Volts
Amplification Factor (Triode Connected).....	28.5

**NOTE:**

(1) Applies to parallel connection only.

**SYNC SEPARATOR and AMPLIFIER**

**12BZ7**

**Double High Mu Triode**

Construction ..... Miniature T-6½  
 Base ..... Button 9 Pin, E9-1  
 Basing ..... 9A  
 Outline ..... 6-3  
 Maximum Diameter ..... 0.875 In.  
 Maximum Seated Height ..... 2.375 In.  
 Maximum Overall Height ..... 2.625 In.

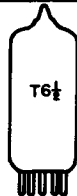
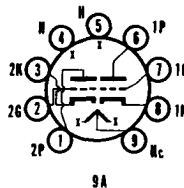

**ELECTRICAL DATA**

**HEATER OPERATION**

Heater Voltage.....	12.6/6.3 Volts
Heater Current.....	300/600 Ma
Maximum Heater-Cathode Voltage	
Heater Negative with Respect to Cathode .....	180 Volts
Heater Positive with Respect to Cathode .....	180 Volts

**DIRECT INTERELECTRODE CAPACITANCES**

	Section No. 1	Section No. 2
Grid to Plate .....	2.5	2.5 Pf
Grid to Cathode and Heater .....	6.5	6.5 Pf
Plate to Cathode and Heater .....	0.7	0.55 Pf
Plate (Section 1) to Plate (Section 2).....	1.3	Pf

**RATINGS (Design Center Rating System)**

**Class A1 Amplifier (Each Section)**

Plate Voltage (Max.) .....	300 Volts
Grid Voltage	
Negative Bias Value (Max.) .....	-50 Volts
Positive Bias Value (Max.) .....	0 Volt
Plate Dissipation (Max.) .....	1.5 Watts

**CHARACTERISTICS AND TYPICAL OPERATION**

Plate Voltage .....	250 Volts
Grid Voltage .....	-2 Volts
Amplification Factor .....	100
Plate Resistance (Approx.) .....	31,800 Ohms
Transconductance .....	3200 $\mu$ mhos
Plate Current .....	2.5 Ma
Grid Circuit Resistance (Contact Bias Operation).....	5 Megohms

12EK6

RF/IF AMPLIFIER

**Sharp Cutoff Pentode**

Construction .....	Miniature T-5½
Base .....	Button 7 Pin, E7-1
Basing .....	.7BK
Outline .....	5-2
Maximum Diameter .....	0.750 In.
Maximum Seated Height .....	1.875 In.
Maximum Overall Height .....	2.125 In.

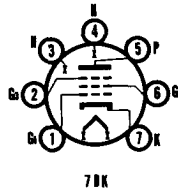

**ELECTRICAL DATA**

**HEATER OPERATION**

Heater Voltage <sup>(1)</sup> .....	12.6 Volts
Heater Current .....	200 Ma
Maximum Heater-Cathode Voltage	
Heater Negative with Respect to Cathode .....	16 Volts
Heater Positive with Respect to Cathode .....	16 Volts

**DIRECT INTERELECTRODE CAPACITANCES (Unshielded)**

Grid to Plate (Max.).....	0.032 Pf
Input: g <sub>1</sub> to (h + k + g <sub>2</sub> + g <sub>3</sub> ) .....	10 Pf
Output: p to (h + k + g <sub>2</sub> + g <sub>3</sub> ) .....	5.5 Pf

**RATINGS (Design Maximum Rating System)**

Plate Voltage (Max.) .....	16 Volts
Grid No. 2 Voltage (Max.) .....	16 Volts
Positive DC Grid No. 1 Voltage .....	0 Volt
Grid No. 1 Circuit Resistance (Max.) .....	10 Megohms

**CHARACTERISTICS AND TYPICAL OPERATION**

Plate Voltage .....	12.6 Volts
Grid No. 2 Voltage .....	12.6 Volts
Grid No. 1 Voltage <sup>(2)</sup> .....	— Volt
Grid No. 1 Resistor .....	2.2 Megohms
Plate Current .....	4.4 Ma
Grid No. 2 Current .....	2.0 Ma
Transconductance .....	4200 $\mu$ mhos
Plate Resistance (Approx.) .....	40,000 Ohms
Grid No. 1 Voltage for I <sub>b</sub> = 10 $\mu$ a .....	-4 Volts

**NOTES:**

(1) This tube is intended for use in automobile radios operated from a nominal 12 volt battery. Design of the tube is such that the heater will operate satisfactorily over the range



from 10.0 to 15.9 V, and that the maximum ratings provide a safety factor for the wide voltage variations encountered in this type of supply system.

(2) Average contact potential bias developed across specified grid resistor.

**DETECTOR and AF AMPLIFIER**

**12F8**

**Double Diode and Remote Cutoff Pentode**

Construction ..... Miniature T-6½  
 Base ..... Button 9 Pin, E9-1  
 Basing ..... 9FH  
 Outline ..... 6-2  
 Maximum Diameter ..... 0.875 In.  
 Maximum Seated Height ..... 1.937 In.  
 Maximum Overall Height ..... 2.187 In.

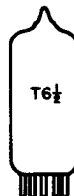
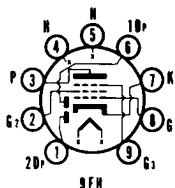

**ELECTRICAL DATA**

**HEATER OPERATION**

Heater Voltage <sup>(1)</sup> .....	12.6 Volts
Heater Current .....	150 Ma
Maximum Heater-Cathode Voltage	
Heater Negative with Respect to Cathode .....	30 Volts
Heater Positive with Respect to Cathode .....	30 Volts

**DIRECT INTERELECTRODE CAPACITANCES**

Grid to Plate .....	0.06 Pf
Input: g1 to (g2 + g3 + h + k) .....	4.5 Pf
Output: p to (g2 + g3 + h + k) .....	3.0 Pf
Diode to Diode.....	0.3 Pf

**RATINGS (Design Center Rating System)**

Plate Voltage (Max.) .....	30 Volts
Grid No. 2 Voltage (Max.) .....	30 Volts
Positive DC Grid No. 1 Voltage (Max.) .....	0 Volt
Grid No. 1 Circuit Resistance (Max.) .....	10 Megohms
Average Diode Current (Max.) .....	1.0 Ma

**CHARACTERISTICS AND TYPICAL OPERATION**

Plate Voltage .....	12.6 Volts
Grid No. 2 Voltage .....	12.6 Volts
Grid No. 1 Voltage .....	0 Volt
Plate Current .....	1.0 Ma
Grid No. 2 Current .....	0.38 Ma
Transconductance .....	1000 μmhos
Plate Resistance (Approx.) .....	0.33 Megohm
Grid No. 1 Voltage (Approx.) for Gm = 10 μmhos.....	-5 Volts
Average Diode Current with 10 Volts DC Applied (Test Condition Only) .....	2 Ma

**NOTE:**

(1) This tube is intended for use in automobile radios operated from a nominal 12 volt battery. Design of the tube is such that the heater will operate satisfactorily over the range of 10.0 volts to 15.9 volts, and that the maximum ratings provide a safety factor for the wide voltage variation encountered with this type of supply.

Color Television Type  
**VIDEO AMPLIFIER**

**12GN7A/12HG7**

**Sharp Cutoff Pentode**

Construction ..... Miniature T-6½  
 Base ..... Button 9 Pin, E9-1  
 Basing ..... 9BF  
 Outline ..... 6-3  
 Maximum Diameter ..... 0.875 In.  
 Maximum Seated Height ..... 2.375 In.  
 Maximum Overall Height ..... 2.625 In.

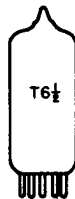
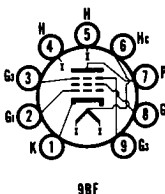

**ELECTRICAL DATA**

**HEATER OPERATION**

	Parallel	Series
Heater Voltage .....	12.6	6.3 Volts
Heater Current .....	300	600 Ma
Heater Warm-up Time <sup>(1)</sup> .....	—	11 Seconds
<b>Maximum Heater-Cathode Voltage</b>		
Heater Negative with Respect to Cathode		
Total DC and Peak .....		200 Volts
Heater Positive with Respect to Cathode		
DC .....		100 Volts
Total DC and Peak .....		200 Volts

**DIRECT INTERELECTRODE CAPACITANCES (Unshielded)**

Grid No. 1 to Plate .....	0.12 Pf
Input: g1 to (h + k, g3, IS + g2) .....	17.5 Pf
Output: p to (h + k, g3, IS + g2) .....	4.0 Pf

**RATINGS (Design Maximum Rating System)**

Plate Voltage (Max.) .....	400 Volts
Grid No. 2 Supply Voltage (Max.) .....	330 Volts
Grid No. 2 Voltage .....	See Rating Chart (Gen. Info. Sec.)
Positive Grid No. 1 Voltage (Max.) .....	0 Volt
Plate Dissipation (Max.) .....	11.5 Watts
Grid No. 2 Dissipation (Max.) .....	1.5 Watts
Grid No. 1 Circuit Resistance (Max.) .....	0.25 Megohm

Control grid to cathode spacing of this type is of such low order of magnitude as to preclude the use of voltage between these elements of more than 50 volts DC or peak AC in commercial tube checkers and shorts indicating devices, particularly where mechanical excitation of the tube is employed.

**CHARACTERISTICS AND TYPICAL OPERATION**

Plate Voltage .....	250 Volts
Grid No. 2 Voltage .....	150 Volts
Grid No. 1 Voltage .....	0 Volt
Cathode Bias Resistor .....	56 Ohms
Plate Current .....	28 Ma
Grid No. 2 Current .....	6.5 Ma
Transconductance .....	36,000 $\mu$ mhos
Plate Resistance (Approx.) .....	50,000 Ohms
E <sub>c1</sub> for I <sub>b</sub> = 100 $\mu$ a (Approx.) .....	-5.7 Volts

**INSTANTANEOUS PLATE KNEE CHARACTERISTICS<sup>(2)</sup>**

E<sub>b</sub> = 50 V, E<sub>c2</sub> = 125 V, and E<sub>c1</sub> = 0 V  
 I<sub>b</sub> = 70 Ma, and I<sub>c2</sub> = 24 Ma

**NOTES:**

- (1) Applies to 6.3/600 Ma only.
- (2) Applied for short interval (2 Sec. Max.) so as not to damage tube.

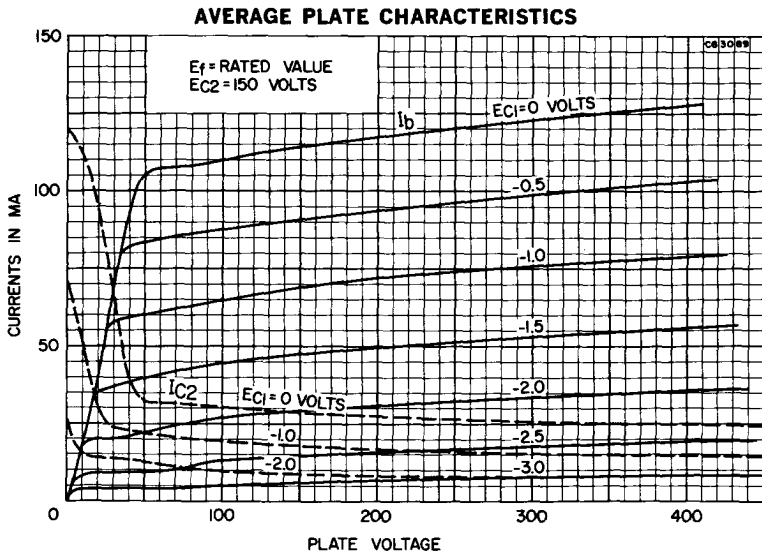

Color Television Type  
**VIDEO AMPLIFIER**

**12HL7****Sharp Cutoff Pentode**

Construction ..... Miniature T-6½  
 Base ..... Button 9 Pin, E9-1  
 Basing ..... 9BF  
 Outline ..... 6-3  
 Maximum Diameter ..... 0.875 In.  
 Maximum Seated Height ..... 2.375 In.  
 Maximum Overall Height ..... 2.625 In.

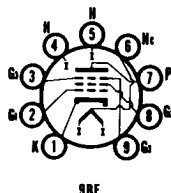
**ELECTRICAL DATA****HEATER OPERATION**

	Parallel	Series
Heater Voltage.....	12.6	6.3 Volts
Heater Current .....	300	600 Ma
Heater Warm-up Time <sup>(1)</sup> .....	—	11 Seconds
Maximum Heater-Cathode Voltage		
Heater Negative with Respect to Cathode		
Total DC and Peak.....		200 Volts
Heater Positive with Respect to Cathode		
DC .....		100 Volts
Total DC and Peak.....		200 Volts

**DIRECT INTERELECTRODE CAPACITANCES (Unshielded)**

Grid No. 1 to Plate .....	0.15 Pf
Input: g1 to (k + g3 + IS + g2 + h).....	15.0 Pf
Output: p to (k + g3 + IS + g2 + h).....	6.0 Pf

**RATINGS (Design Maximum Rating System)**

Plate Voltage (Max.) .....	400 Volts
Positive DC Grid No. 3 Voltage (Max.) .....	0 Volt
Grid No. 2 Supply Voltage (Max.) .....	330 Volts
Grid No. 2 Voltage .....	See Rating Chart (Gen. Info. Sec.)
Positive DC Grid No. 1 Voltage (Max.) .....	0 Volt
Plate Dissipation (Max.) .....	10.0 Watts
Grid No. 2 Dissipation (Max.) .....	1.0 Watt
Grid No. 1 Circuit Resistance	
Fixed Bias (Max.) .....	0.1 Megohm
Cathode Bias (Max.) .....	0.25 Megohm

Control grid to cathode spacing on this type is of such low order of magnitude as to preclude the use of voltage between these elements of more than 50 volts DC or peak AC in commercial tube checkers and shorts indicating devices, particularly where mechanical excitation of the tube is employed.

**CHARACTERISTICS AND TYPICAL OPERATION**

Plate Voltage .....	250 Volts
Grid No. 2 Supply Voltage.....	150 Volts
Grid No. 1 Voltage .....	0 Volt
Grid No. 3 Voltage (Referred to Negative End of Rk).....	0 Volt
Cathode Resistor (Bypassed) .....	122 Ohms
Plate Current .....	25 Ma
Grid No. 2 Current .....	6 Ma
Transconductance (Grid No. 1 to Plate).....	21,000 $\mu$ mhos
Plate Resistance (Approx.) .....	55,000 Ohms
Grid No. 1 Voltage (Approx.) for $I_b = 100 \mu$ a ( $R_k = 0$ ) .....	-7.2 Volts

**INSTANTANEOUS PLATE KNEE CHARACTERISTICS<sup>(2)</sup>**

$E_b = 50$  V,  $E_{c2} = 125$  V,  $E_{c1} = 0$  V and  $E_{c3} = 0$  V  
 $I_b = 76$  Ma, and  $I_{c2} = 32$  Ma

**NOTES:**

- (1) Applies to 6.3 volt connection only.
- (2) Current drawn only for short intervals so as not to damage the tube.

# 14BL11

## VIDEO AMPLIFIER (P) GENERAL PURPOSE AMPLIFIERS(T)

### High Mu Triode, Medium Mu Triode and Sharp Cutoff Pentode

Construction..... Compactron T-9  
 Base ..... Button 12 Pin, E12-70  
 Basing ..... 12GC  
 Outline ..... 9-58  
 Maximum Diameter ..... 1.188 In.  
 Maximum Seated Height ..... 2.000 In.  
 Maximum Overall Height ..... 2.375 In.

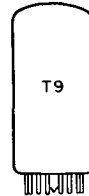
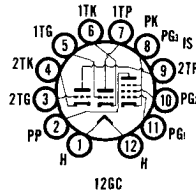

### ELECTRICAL DATA HEATER OPERATION

Heater Voltage.....	14.2 Volts
Heater Current .....	450 Ma
Heater Warm-up Time .....	11 Seconds
Maximum Heater-Cathode Voltage	
Heater Negative with Respect to Cathode	
Total DC and Peak.....	200 Volts
Heater Positive with Respect to Cathode	
DC .....	100 Volts
Total DC and Peak.....	200 Volts

### DIRECT INTERELECTRODE CAPACITANCES (Unshielded) Triode (Section 1)

Grid to Plate .....	1.9 Pf
Input: 1Tg to (1Tk + Pk + Pg3 + h + IS) .....	3.0 Pf
Output: 1Tp to (1Tk + Pk + Pg3 + h + IS) .....	2.4 Pf

### Triode (Section 2)

Grid to Plate .....	2.6 Pf
Input: 2Tg to (2Tk + Pk + Pg3 + h + IS) .....	4.4 Pf
Output: 2Tp to (2Tk + Pk + Pg3 + h + IS) .....	4.0 Pf

### Pentode Section

Grid No. 1 to Plate .....	0.12 Pf
Input: Pg1 to (Pk + Pg2 + Pg3 + h + IS) .....	12 Pf
Output: P to (Pk + Pg2 + Pg3 + h + IS) .....	4.4 Pf

### Coupling

Pentode Plate to Triode Plate (Section 2) .....	0.05 Pf
Triode Plate (Section 1) to Triode Plate (Section 2) .....	0.12 Pf

### RATINGS (Design Maximum Rating System)

#### Pentode Section

Plate Voltage (Max.) .....	250 Volts
Screen Voltage (Max.) .....	125 Volts
Positive DC Grid No. 1 Voltage (Max.) .....	0 Volt
Plate Dissipation (Max.) .....	2.5 Watts
Screen Dissipation (Max.) .....	1.25 Watts
Grid No. 1 Circuit Resistance	
Fixed Bias (Max.) .....	0.1 Megohm
Cathode Bias (Max.) .....	0.25 Megohm

#### Triode (Section 1)

Plate Voltage (Max.) .....	330 Volts
Positive DC Grid Voltage (Max.) .....	0 Volt
Plate Dissipation (Max.) .....	1.5 Watts
Grid Circuit Resistance	
Fixed Bias (Max.) .....	0.5 Megohm
Cathode Bias (Max.) .....	1.0 Megohm

#### Triode (Section 2)

Plate Voltage (Max.) .....	330 Volts
Positive DC Grid Voltage (Max.) .....	0 Volt
Plate Dissipation (Max.) .....	2.0 Watts
Grid Circuit Resistance	
Fixed Bias (Max.) .....	0.5 Megohm
Cathode Bias (Max.) .....	1.0 Megohm

**CHARACTERISTICS AND TYPICAL OPERATION**

**Pentode Section**

Plate Voltage .....	35	200 Volts
Screen Voltage .....	100	100 Volts
Grid No. 1 Voltage .....	0	— Volts
Cathode Bias Resistor .....	—	82 Ohms
Plate Resistance (Approx.) .....	—	70,000 Ohms
Transconductance .....	—	19,000 $\mu$ mhos
Plate Current .....	40	16 Ma
Screen Current .....	13	3.0 Ma
Grid No. 1 Voltage (Approx.) $I_b = 100 \mu a$ .....	—	-5.5 Volts

**Triode (Section 1)**

Plate Voltage .....	200 Volts
Cathode Bias Resistor .....	270 Ohms
Amplification Factor .....	69
Plate Resistance (Approx.) .....	12,500 Ohms
Transconductance .....	5500 $\mu$ mhos
Plate Current .....	7.1 Ma
Grid Voltage (Approx.) $I_b = 50 \mu a$ .....	-5.5 Volts

**Triode (Section 2)**

Plate Voltage .....	200 Volts
Cathode Bias Resistor .....	470 Ohms
Amplification Factor .....	40
Plate Resistance (Approx.) .....	7600 Ohms
Transconductance .....	5300 $\mu$ mhos
Plate Current .....	7.2 Ma
Grid Voltage (Approx.) $I_b = 100 \mu a$ .....	-8 Volts

**VIDEO AMPLIFIER (P)  
GENERAL PURPOSE AMPLIFIER (T)  
SYNC SEPARATOR (T)**

**14BR11**

**High Mu Triode, Medium Mu Triode and Sharp Cutoff Pentode**

Construction .....	Compactron T-9
Base .....	Button 12 Pin, E12-70
Basing .....	12GL
Outline .....	9-59
Maximum Diameter .....	1.188 In.
Maximum Seated Height .....	2.250 In.
Maximum Overall Height .....	2.625 In.

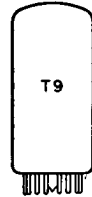
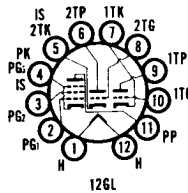

**ELECTRICAL DATA**

**HEATER OPERATION**

Heater Voltage .....	14.2 Volts
Heater Current .....	450 Ma
Heater Warm-up Time .....	11 Seconds
Maximum Heater-Cathode Voltage	
Heater Negative with Respect to Cathode	
Total DC and Peak .....	200 Volts
Heater Positive with Respect to Cathode	
DC .....	100 Volts
Total DC and Peak .....	200 Volts

**DIRECT INTERELECTRODE CAPACITANCES (Unshielded)**

**Triode (Section 1)**

Grid to Plate .....	1.9 Pf
Input: 1Tg to (1Tk + 2Tk + Pk + Pg3 + h + IS) .....	2.4 Pf
Output: 1Tp to (1Tk + 2Tk + Pk + Pg3 + h + IS) .....	2.2 Pf

**Triode (Section 2)**

Grid to Plate .....	3.8 Pf
Input: 2Tg to (2Tk + Pk + Pg3 + h + IS) .....	2.8 Pf
Output: 2Tp to (2Tk + Pk + Pg3 + h + IS) .....	3.8 Pf

**Pentode Section**

Grid No. 1 to Plate .....	0.13 Pf
Input: Pg1 to (2Tk + Pk + Pg2 + Pg3 + h + IS) .....	10 Pf
Output: Pp to (2Tk + Pk + Pg2 + Pg3 + h + IS) .....	4.6 Pf

**Coupling**

Pentode Plate to Triode Plate (Section 2) (Max.) .....	0.16 Pf
Triode Plate (Section 1) to Triode Plate (Section 2) .....	0.2 Pf

**RATINGS (Design Maximum Rating System)**

**Pentode Section**

Plate Voltage .....	330 Volts
Screen Supply Voltage .....	330 Volts
Screen Voltage .....	See Rating Chart (Gen. Info. Sec.)
Positive DC Grid No. 1 Voltage .....	0 Volt
Plate Dissipation .....	4.0 Watts
Screen Dissipation .....	1.1 Watts
Grid No. 1 Circuit Resistance	
Fixed Bias .....	1.0 Megohm
Cathode Bias .....	1.0 Megohm

**Triode (Section 1)**

Plate Voltage .....	330 Volts
Positive DC Grid Voltage .....	0 Volt
Plate Dissipation .....	1.5 Watts
Grid Circuit Resistance	
Fixed Bias .....	0.5 Megohm
Cathode Bias .....	1.0 Megohm

**Triode (Section 2)**

Plate Voltage .....	330 Volts
Positive DC Grid Voltage .....	0 Volt
Plate Dissipation .....	2.0 Watts
Grid Circuit Resistance	
Fixed Bias .....	0.5 Megohm
Cathode Bias .....	1.0 Megohm

**CHARACTERISTICS AND TYPICAL OPERATION**

**Pentode Section**

Plate Voltage .....	35	135 Volts
Screen Voltage .....	135	135 Volts
Grid No. 1 Voltage .....	0	— Volt
Cathode Bias Resistor .....	—	100 Ohms
Plate Resistance (Approx.) .....	—	45,000 Ohms
Transconductance .....	—	10,400 $\mu$ mhos
Plate Current .....	34	17 Ma
Screen Current .....	13	4.0 Ma
Grid No. 1 Voltage (Approx.)		
I <sub>b</sub> = 100 $\mu$ a .....	—	-6 Volts

**Triode (Section 1)**

Plate Voltage .....	200 Volts
Grid Voltage .....	-2.0 Volts
Amplification Factor .....	68
Plate Resistance (Approx.) .....	12,400 Ohms
Transconductance .....	5500 $\mu$ mhos
Plate Current .....	7.0 Ma
Grid Voltage (Approx.)	
I <sub>b</sub> = 100 $\mu$ a .....	-5.5 Volts

**Triode (Section 2)**

Plate Voltage .....	200 Volts
Cathode Bias Resistor .....	220 Ohms
Amplification Factor .....	41
Plate Resistance (Approx.) .....	9400 Ohms
Transconductance .....	4400 $\mu$ mhos
Plate Current .....	9.2 Ma
Grid Voltage (Approx.)	
I <sub>b</sub> = 100 $\mu$ a .....	-6.5 Volts

**14GT8A**

**FM DETECTOR  
AF AMPLIFIER**

**Double Diode and High Mu Triode**

Construction .....	Miniature T-6½
Base .....	Button 9 Pin, E9-1
Basing .....	9KR
Outline .....	6-2
Maximum Diameter .....	0.875 In.
Maximum Seated Height .....	1.937 In.
Maximum Overall Height .....	2.187 In.

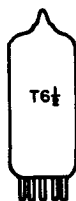
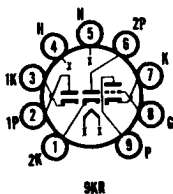

**ELECTRICAL DATA**

**HEATER OPERATION**

Heater Voltage.....	14 Volts
Heater Current .....	150 Ma
Heater Warm-up Time .....	17 Seconds
Maximum Heater-Cathode Voltage	
Heater Negative with Respect to Cathode	
Total DC and Peak.....	200 Volts
Heater Positive with Respect to Cathode	
DC .....	100 Volts
Total DC and Peak.....	200 Volts

**DIRECT INTERELECTRODE CAPACITANCES (Unshielded)**

**Triode Section**

Grid to Plate .....	1.8 Pf
Input: g to (h + tk) .....	1.6 Pf
Output: p to (h + tk) .....	0.24 Pf

**Diode Section**

Diode No. 1 Input .....	2.4 Pf
Diode No. 2 Input .....	2.4 Pf
Diode No. 1 Cathode to All.....	6.5 Pf
Diode No. 2 Cathode to All.....	6.5 Pf

**Coupling**

Grid to Diode Plate No. 1 (Max.) .....	0.09 Pf
Grid to Diode Plate No. 2 (Max.) .....	0.07 Pf

**RATINGS (Design Maximum Rating System)**

**Triode**

Plate Voltage (Max.) .....	330 Volts
Positive DC Grid Voltage (Max.) .....	0 Volt
Plate Dissipation (Max.) .....	1.1 Watts

**Diodes**

DC Current (Each Plate) (Max.) .....	5.0 Ma
--------------------------------------	--------

**CHARACTERISTICS AND TYPICAL OPERATION**

**Class A1 Amplifier**

Plate Voltage .....	250 Volts
Grid Voltage .....	-3 Volts
Plate Current .....	0.7 Ma
Transconductance .....	1000 $\mu$ mhos
Amplification Factor .....	72
Plate Resistance (Approx.) .....	72,000 Ohms

**Diodes**

Average Current Each Plate with 5 Volts DC Applied <sup>(1)</sup> .....	18 Ma
---	-------

**NOTE:**

(1) Test condition only.

**OSCILLATOR (T)  
AUDIO POWER AMPLIFIER (P)**

**16A8/PCL82**  
8B8, 11BM8

**Triode and Pentode**

Construction .....	Miniature T-6½
Base .....	Button 9 Pin, E9-1
Basing .....	9EX
Outline .....	6-4
Maximum Diameter .....	0.875 In.
Maximum Seated Height .....	2.812 In.
Maximum Overall Height .....	3.062 In.

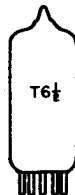
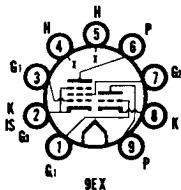

**ELECTRICAL DATA**

**HEATER OPERATION**

	8B8	11BM8	16A8/PCL82
Heater Voltage.....	8	10.7	16 Volts
Heater Current .....	600	450	300 Ma
Maximum Heater-Cathode Voltage			
Heater Negative with Respect to Cathode .....			200 Volts
Heater Positive with Respect to Cathode .....			200 Volts

**DIRECT INTERELECTRODE CAPACITANCES****Triode Section**

Grid to All Other Elements Except Plate .....	2.7 Pf
Plate to All Other Elements Except Grid .....	4.3 Pf
Plate to Grid .....	4.2 Pf
Grid to Heater (Max.) .....	0.02 Pf

**Pentode Section**

Grid No. 1 to All Other Elements Except Plate .....	9.3 Pf
Plate to All Other Elements Except Grid No. 1 .....	8.0 Pf
Plate to Grid No. 1 (Max.) .....	0.3 Pf
Grid No. 1 to Heater (Max.) .....	0.3 Pf

**Coupling**

Triode Plate to Pentode Grid No. 1 (Max.) .....	0.02 Pf
Triode Grid to Pentode Plate (Max.) .....	0.02 Pf
Triode Grid to Pentode Grid No. 1 (Max.) .....	0.025 Pf
Triode Plate to Pentode Plate (Max.) .....	0.25 Pf

**RATINGS (Design Center Rating System)****Pentode Section**

Plate Voltage Without Plate Current (Max.) .....	550 Volts
Plate Voltage (Max.) .....	250 Volts
Peak Plate Voltage (Max.) <sup>(1)</sup> .....	2500 Volts
Peak Inverse Plate Voltage (Max.) .....	500 Volts
Plate Dissipation (Max.) .....	5 Watts
Peak Plate Dissipation (Max.) .....	7 Watts
Grid No. 2 Voltage Without Current (Max.) .....	550 Volts
Grid No. 2 Voltage (Max.) .....	250 Volts
Grid No. 2 Dissipation (Max.) .....	1.8 Watts
Peak Grid No. 2 Dissipation (Max.) .....	3.2 Watts
Cathode Current (Max.) .....	50 Ma
Grid No. 1 Circuit Resistance With Automatic Bias (Max.) .....	2 Megohms
Grid No. 1 Circuit Resistance With Fixed Bias (Max.) .....	1 Megohm
Circuit Resistance Between Heater and Cathode (Max.) .....	20,000 Ohms

**Triode Section**

Plate Voltage Without Plate Current (Max.) .....	550 Volts
Plate Voltage (Max.) .....	250 Volts
Peak Plate Voltage (Max.) <sup>(1)</sup> .....	600 Volts
Plate Dissipation (Max.) .....	1 Watt
Cathode Current (Max.) .....	15 Ma
Grid Circuit Resistance With Automatic Bias (Max.) .....	3 Megohms
Grid Circuit Resistance With Fixed Bias (Max.) .....	1 Megohm
Voltage Between Heater and Cathode (Max.) .....	200 Volts
Circuit Resistance Between Heater and Cathode (Max.) .....	20,000 Ohms
Grid Circuit Impedance (Freq. = 50 Hz) (Max.) .....	0.5 Megohm

**CHARACTERISTICS AND TYPICAL OPERATION****Pentode Section**

Plate Voltage .....	100	170	200	200 Volts
Grid No. 2 Voltage .....	100	170	200	200 Volts
Grid No. 1 Bias .....	-6.0	-11.5	-12.5	-16 Volts
Plate Current .....	26	41	35	35 Ma
Grid No. 2 Current .....	5.0	8.0	6.5	7.0 Ma
Transconductance .....	6800	7500	6800	6400 $\mu$ mhos
Plate Resistance .....	15,000	16,000	20,500	20,000 Ohms
Amplification Factor of Grid No. 2				
With Respect to Grid No. 1 .....	10	9.5	9.5	9.5

**Triode Section**

Plate Voltage .....	100 Volts
Grid Voltage .....	0 Volt
Plate Current .....	3.5 Ma
Transconductance .....	2500 $\mu$ mhos
Amplification Factor .....	70

**NOTE:**

(1) Maximum pulse duration 4% of one cycle with a maximum of 0.8 millisecond.



# DAMPER

# 16AQ3/XY88

### Heater-Cathode Diode

Construction ..... Miniature T-6½  
 Base ..... Button 9 Pin, E9-1  
 Top Cap ..... C1-2  
 Basing ..... 9CB  
 Outline  
 Maximum Diameter ..... 0.875 In.  
 Maximum Seated Height ..... 3.250 In.  
 Maximum Overall Height ..... 3.500 In.

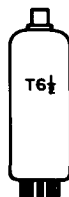
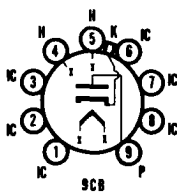

### ELECTRICAL DATA

#### HEATER OPERATION

Heater Voltage.....	16.4 Volts
Heater Current .....	600 Ma
Maximum Heater-Cathode Voltage (Peak) .....	6600 Volts

#### DIRECT INTERELECTRODE CAPACITANCES

Plate to All Other Elements .....	8.6 Pf
Cathode to Heater .....	2.0 Pf

#### RATINGS (Design Center Rating System)

Supply Voltage (Without Current) (Max.) .....	550 Volts
Supply Voltage (Max.) .....	250 Volts
Plate Current (Max.) .....	220 Ma
Peak Plate Current (Max.) .....	550 Ma
Plate Dissipation (Max.) .....	5 Watts
Peak Negative Plate Voltage <sup>(1)</sup> , <sup>(2)</sup> (Max.).....	6000 Volts

### NOTES:

- (1) Maximum pulse duration 22% of a cycle with a maximum of 18 μsec.
- (2) Absolute maximum ratings 7500 volts.

# HORIZONTAL DEFLECTION AMPLIFIER

# 16KA6

21KA6

### Beam Power Pentode

Construction..... Compactron T-12  
 Base ..... Button 12 Pin, E12-74  
 Top Cap ..... C1-3  
 Basing ..... 12GH  
 Outline  
 Maximum Diameter ..... 1.563 In.  
 Maximum Seated Height ..... 3.250 In.  
 Maximum Overall Height ..... 3.625 In.

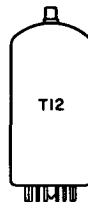
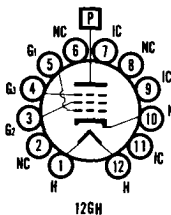

### ELECTRICAL DATA

#### HEATER OPERATION

	21KA6	16KA6
Heater Voltage.....	21	15.8 Volts
Heater Current .....	450	600 Ma
Heater Warm-up Time .....	11	11 Seconds
Maximum Heater-Cathode Voltage		
Heater Negative with Respect to Cathode		
Total DC and Peak.....		200 Volts
Heater Positive with Respect to Cathode		
DC .....		100 Volts
Total DC and Peak.....		200 Volts

**DIRECT INTERELECTRODE CAPACITANCES (Unshielded)**

Grid No. 1 to Plate .....	0.6 Pf
Input: g1 to (h + k + g3).....	23 Pf
Output: p to (h + k + g2 + g3) .....	8.5 Pf

**RATINGS (Design Maximum Rating System)**

**Horizontal Deflection Amplifier<sup>(1)</sup>**

DC Plate Supply Voltage (Boost + DC Power Supply) (Max.) .....	770 Volts
Peak Positive Pulse Plate Voltage (Max.) .....	6500 Volts
Peak Negative Pulse Plate Voltage (Max.) .....	1500 Volts
Plate Dissipation (Max.) <sup>(2)</sup> .....	18 Watts
Negative Grid No. 1 Voltage (Max.) .....	55 Volts
Peak Negative Grid No. 1 Voltage (Max.) .....	330 Volts
Grid No. 2 Voltage (Max.) .....	220 Volts
Grid No. 2 Dissipation (Max.) .....	3.5 Watts
Positive DC Grid No. 3 Voltage (Max.) .....	70 Volts
Average Cathode Current (Max.).....	230 Ma
Peak Cathode Current (Max.) .....	800 Ma
Grid No. 1 Circuit Resistance (Max.) .....	1.0 Megohm
Bulb Temperature (At Hottest Point) (Max.) .....	220 °C

**CHARACTERISTICS AND TYPICAL OPERATION**

Plate Voltage .....	5000	130 Volts
Grid No. 3 Voltage .....	0	0 Volt
Grid No. 2 Voltage .....	130	130 Volts
Grid No. 1 Voltage .....	—	-20 Volts
Plate Current .....	—	50 Ma
Grid No. 2 Current .....	—	1.75 Ma
Transconductance .....	—	9100 μmhos
Plate Resistance.....	—	11,000 Ohms
Amplification Factor <sup>(3)</sup> .....	—	4.7
Ec1 for Ib = 1.0 Ma (Approx.) .....	-66	-33 Volts

**INSTANTANEOUS PLATE KNEE VALUES**

Eb = 60 V; Ec2 = 130 V, Ec1 = 0 V and Ec3 = 0 V  
 Ib = 410 Ma; and Ic2 = 24 Ma  
 Eb = 60 V; Ec2 = 130 V, Ec1 = 0 V and Ec3 = +25 V  
 Ib = 410 Ma; Ic2 = 23 Ma and Ic3 = 2 Ma

**NOTES:**

- (1) For operation in a 525 line, 30 frame system as described in "Standards of Good Engineering Practice for Television Broadcast Stations; Federal Communications Commission," the duty cycle of the voltage pulse must not exceed 15% of one horizontal scanning cycle.
- (2) In stages operating with grid leak bias, an adequate cathode bias resistor or other suitable means is required to protect the tube in the absence of excitation.
- (3) Amplification factor with tube operating as a triode with 130 volts on the plate and Grid No. 2 and -20 volts on Grid No. 1.

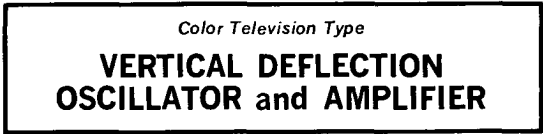

**High Mu Triode and Beam Power Pentode**

Construction.....	Compactron T-12
Base .....	E12-74
Basing .....	12DZ
Outline .....	12-56
Maximum Diameter .....	1.562 In.
Maximum Seated Height .....	2.500 In.
Maximum Overall Height .....	2.875 In.

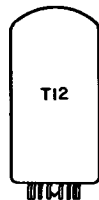
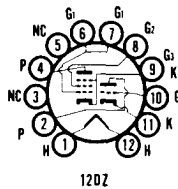

**ELECTRICAL DATA**

**HEATER OPERATION**

Heater Voltage.....	16 Volts
Heater Current .....	600 Ma
Heater Warm-up Time .....	11 Seconds

The 16LU8A is identical to the 6LU8 except for shorter bulb length and Heater Characteristic

**FM LIMITER/DISCRIMINATOR  
AUDIO POWER AMPLIFIER**

**17AB10**

**Double Dissimilar Pentode**

Construction.....Compactron T-9  
 Base .....Button 12 Pin, E12-70  
 Basing .....12BT  
 Outline .....9-58  
 Maximum Diameter .....1.188 In.  
 Maximum Seated Height .....2.000 In.  
 Maximum Overall Height .....2.375 In.

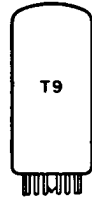
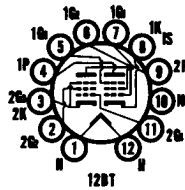

**ELECTRICAL DATA**

**HEATER OPERATION**

Heater Voltage.....	16.8 Volts
Heater Current.....	450 Ma
Heater Warm-up Time.....	11 Seconds
Maximum Heater-Cathode Voltage	
Heater Negative with Respect to Cathode	
Total DC and Peak.....	200 Volts
Heater Positive with Respect to Cathode	
DC.....	100 Volts
Total DC and Peak.....	200 Volts

**DIRECT INTERELECTRODE CAPACITANCES (Unshielded)**

**Gated-Beam Discriminator Section No. 1**

Grid No. 1 to Grid No. 3 .....	0.01 Pf
Grid No. 1 to All.....	4.4 Pf
Grid No. 3 to All.....	3.2 Pf

**Audio Amplifier Section No. 2**

Grid No. 1 to Plate .....	0.22 Pf
Input .....	12 Pf
Output .....	7.5 Pf

**RATINGS (Design Maximum Rating System)**

**Gated-Beam Discriminator Section No. 1**

Plate-Supply Voltage.....	330 Volts
Accelerator-Supply Voltage.....	330 Volts
Peak Positive Grid No. 1 Voltage .....	60 Volts
DC Cathode Current.....	13 Ma

**Audio Amplifier No. 2**

Plate Voltage .....	165 Volts
Screen Voltage.....	150 Volts
Plate Dissipation .....	6.5 Watts
Screen Dissipation.....	1.8 Watts
DC Cathode Current.....	65 Ma

**Grid No. 1 Circuit Resistance**

Fixed Bias .....	0.25 Megohm
Cathode Bias .....	0.5 Megohm

**CHARACTERISTICS AND TYPICAL OPERATION**

**Gated-Beam Discriminator Section No. 1**

Plate Voltage .....	135	135	135 Volts
Accelerator Voltage.....	75	—	— Volts
Accelerator-Supply Voltage .....	—	280	280 Volts
Accelerator Resistor .....	—	33,000	33,000 Ohms
Grid No. 1 Voltage .....	0	0	0 Volt
Grid No. 3 Voltage .....	+4.0	+4.0	0 Volts
Plate Current .....	—	5.0	— Ma
Accelerator Current .....	4.5	—	— Ma
Grid No. 1 Transconductance .....	—	—	360 $\mu$ mhos
Grid No. 3 Transconductance .....	—	—	700 $\mu$ mhos
Grid No. 1 Voltage (Approx.) Ib = 20 $\mu$ a .....	—	—	-4 Volts
Grid No. 3 Voltage (Approx.) Ib = 20 $\mu$ a .....	—	—	-4 Volts

**Audio Amplifier Section No. 2**

Plate Voltage .....	145 Volts
Screen Voltage.....	110 Volts
Grid No. 1 Voltage .....	-6.0 Volts
Peak AF Grid No. 1 Voltage .....	6.0 Volts
Plate Resistance (Approx.) .....	30,000 Ohms
Transconductance .....	8600 $\mu$ mhos
Zero-Signal Plate Current.....	36 Ma
Maximum Signal Plate Current .....	40 Ma

Zero-Signal Screen Current .....	3.0 Ma
Maximum Signal Screen Current .....	9.0 Ma
Load Resistance .....	3000 Ohms
Total Harmonic Distortion (Approx.) .....	10 Percent
Maximum Signal Power Output .....	2.4 Watts

# 17BF11A

## Color Television Type AUDIO POWER AMPLIFIER FM DETECTOR

### Beam Pentode and Sharp Cutoff Pentode

Construction..... Compactron T-9  
 Base ..... Button 12 Pin, E12-70  
 Basing ..... 12EZ  
 Outline  
 Maximum Diameter ..... 1.188 In.  
 Maximum Seated Height ..... 1.875 In.  
 Maximum Overall Height ..... 2.250 In.  
 The 17BF11A is identical to the 17BF11 except for shorter bulb.

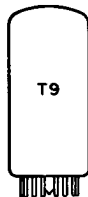
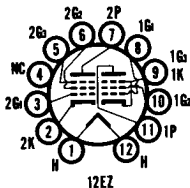

# 17X10

## FM LIMITER/DISCRIMINATOR AUDIO POWER AMPLIFIER

### Double Dissimilar Pentode

Construction..... Compactron T-9  
 Base ..... Button 12 Pin, E12-70  
 Basing ..... 12BT  
 Outline ..... 9-59  
 Maximum Diameter ..... 1.188 In.  
 Maximum Seated Height ..... 2.250 In.  
 Maximum Overall Height ..... 2.625 In.

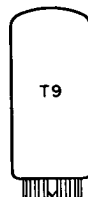
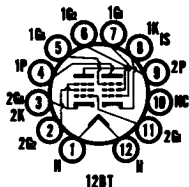

### ELECTRICAL DATA

#### HEATER OPERATION

Heater Voltage .....	16.8 Volts
Heater Current .....	450 Ma
Heater Warm-up Time .....	11 Seconds
Maximum Heater-Cathode Voltage	
Heater Negative with Respect to Cathode	
Total DC and Peak .....	200 Volts
Heater Positive with Respect to Cathode	
DC .....	100 Volts
Total DC and Peak .....	200 Volts

#### DIRECT INTERELECTRODE CAPACITANCES (Unshielded)

##### Section No. 1

Grid No. 1 to (h + 1k + 1g2 + 1g3 + 1S) .....	4.4 Pf
Grid No. 3 to (h + 1k + 1g1 + 1g2 + 1p + 1S) .....	3.2 Pf
Grid No. 1 to Grid No. 3 .....	0.005 Pf

##### Section No. 2

Grid to Plate .....	0.24 Pf
Input: g to (h + 2k + 2g2 + g3 + 1k + 1S) .....	12.0 Pf
Output: p to (h + 2k + 2g2 + g3 + 1k + 1S) .....	9.0 Pf

#### RATINGS (Design Maximum Rating System)

##### Section No. 1

Plate Supply Voltage .....	330 Volts
Accelerator Voltage (G2) .....	110 Volts
Peak Positive G1 Voltage .....	60 Volts
DC Cathode Current .....	13 Ma

##### Section No. 2

Plate Voltage .....	165 Volts
Screen Voltage .....	150 Volts

Plate Dissipation .....	6.5 Watts
Screen Dissipation.....	1.8 Watts
DC Cathode Current .....	65 Ma
Grid No. 1 Circuit Resistance	
Fixed Bias .....	0.25 Megohm
Cathode Bias .....	0.5 Megohm

**CHARACTERISTICS AND TYPICAL OPERATION**

**Section 1**

**Gated Beam Discriminator Section—Limiter/Discriminator Service**

Input Signal Center Frequency .....	10.7	10.7	4.5 MHz
Frequency Deviation .....	± 75	± 75	± 25 KHz
Plate Supply Voltage.....	85	285	270 Volts
Plate Voltage .....	62	122	121 Volts
Accelerator Voltage .....	55	100	100 Volts
Cathode Bias Resistor-Variable <sup>(1)</sup> .....	200-400	200-400	200-400 Ohms
Plate Load Resistor .....	0.085	0.330	0.330 Megohm
Plate Linearity Resistor .....	470	1500	1000 Ohms
Integrating Capacitor .....	0.002	0.001	0.001 μf
Coupling Capacitor .....	0.25	0.01	0.25 μf
Minimum Signal Voltage for Limiting Action, RMS <sup>(2)</sup> ..	1.25	1.25	1.25 Volts
DC Plate Current .....	0.25	0.49	0.44 Ma
Accelerator Current .....	4.1	9.8	10 Ma
Input Signal Level for AM Rejection Adjustment <sup>(1)</sup> .....	1.25	2.0	2.0 Volts
AM Rejection at Esig = 2.0 Volts, RMS .....	31	20	25 db
AM Rejection at Esig = 3.0 Volts, RMS .....	30	29	30 db
Total Harmonic Distortion .....	2.0	1.6	1.8 Percent
Peak Audio Output Voltage .....	6.0	16.6	16.8 Volts

**Section No. 2 Power Amplifier**

Plate Voltage .....	145 Volts
Screen Voltage.....	110 Volts
Grid No. 1 Voltage .....	-6.0 Volts
Peak AF Grid Voltage .....	6.0 Volts
Plate Resistance (Approx.) .....	30,000 Ohms
Transconductance .....	8600 μmhos
Zero Signal Plate Current .....	36 Ma
Maximum Signal Plate Current .....	40 Ma
Zero Signal Screen Current .....	3.0 Ma
Maximum Signal Screen Current .....	9.0 Ma
Load Resistance .....	3000 Ohms
Total Harmonic Distortion (Approx.) .....	10 Percent
Maximum Signal Power Output .....	2.4 Watts

**NOTES:**

- (1) The cathode resistor should be adjusted for maximum AM rejection in the output of the limiter-discriminator stage at the specified signal level. AM rejection is measured with an applied signal containing 30% AM and 30% FM.
- (2) At signal levels above specified value, limiting is within ± 3 decibels. Adequate shielding between components of the limiter grid and the quadrature grid must be used to insure proper phasing of the voltage developed at the quadrature grid. Standard de-emphasis requirements for FM are included. The Q of the quadrature grid circuit should be high enough to develop a minimum of 4 volts (RMS) signal with 2 volts (RMS) of the center-frequency signal applied to the limiter grid. It is recommended that the coil be shunted by a minimum of 10Pf. The capacitance may be composed of tube input capacitance, stray capacitance, and distributed capacitance, as well as physical.

**RF/IF AMPLIFIER**

**18FW6A**

**Semi-Remote Cutoff Pentode**

Construction .....	Miniature T-5½
Base .....	Button 7 Pin, E7-1
Basing .....	7BK
Outline .....	5-2
Maximum Diameter .....	0.750 In.
Maximum Seated Height .....	1.875 In.
Maximum Overall Height .....	2.125 In.

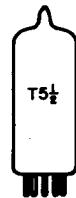
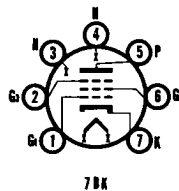

**ELECTRICAL DATA HEATER OPERATION**

Heater Voltage.....	18 Volts
Heater Current .....	100 Ma
Heater Warm-up Time .....	20 Seconds

<b>Maximum Heater-Cathode Voltage</b>	
Heater Negative with Respect to Cathode	
Total DC and Peak .....	100 Volts
Heater Positive with Respect to Cathode	
Total DC and Peak .....	100 Volts

<b>DIRECT INTERELECTRODE CAPACITANCES (Shielded)<sup>(1)</sup></b>	
Grid No. 1 to Plate (Max.) .....	0.0035 Pf
Input .....	5.5 Pf
Output .....	5.0 Pf

<b>RATINGS (Design Maximum Rating System)</b>	
Plate Voltage (Max.) .....	150 Volts
Grid No. 2 Supply Voltage (Max.) .....	150 Volts
Grid No. 2 Voltage .....	See Rating Chart (Gen. Info. Sec.)
Plate Dissipation (Max.) .....	2.5 Watts
Grid No. 2 Dissipation (Max.) .....	0.6 Watt

<b>CHARACTERISTICS AND TYPICAL OPERATION</b>	
Plate Voltage .....	100 Volts
Grid No. 3 Voltage .....	Connected to Cathode at Socket
Grid No. 2 Voltage .....	100 Volts
Cathode Bias Resistor .....	68 Ohms
Plate Current .....	11 Ma
Grid No. 2 Current .....	4.4 Ma
Transconductance .....	4400 $\mu$ mhos
Plate Resistance (Approx.) .....	0.25 Megohm
Grid No. 1 Voltage for gm = 25 $\mu$ mhos .....	-20 Volts

**NOTE:**

(1) External shield No. 316 connected to Pin No. 7 (cathode).



**Pentagrid Type**

Construction .....	Miniature T-5½
Base .....	Button 7 Pin, E7-1
Basing .....	.7CH
Outline .....	.5-2
Maximum Diameter .....	0.750 In.
Maximum Seated Height .....	1.875 In.
Maximum Overall Height .....	2.125 In.

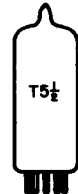
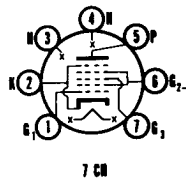

**ELECTRICAL DATA**

**HEATER OPERATION**

Heater Voltage .....	18 Volts
Heater Current .....	100 Ma
Heater Warm-up Time .....	20 Seconds
<b>Maximum Heater-Cathode Voltage</b>	
Heater Negative with Respect to Cathode	
Total DC and Peak .....	100 Volts
Heater Positive with Respect to Cathode	
Total DC and Peak .....	100 Volts

**DIRECT INTERELECTRODE CAPACITANCES**

	Shielded <sup>(1)</sup>	Unshielded
Grid No. 3 to Plate (Max.) .....	0.25	0.30 Pf
Grid No. 3 to Grid No. 1 (Max.) .....	0.15	0.15 Pf
Grid No. 3 Input:		
g3 to (h + k + g1 + g2 + g4 + g5 + p) .....	7.0	7.0 Pf
Grid No. 1 Input:		
g1 to (h + k + g2 + g4 + g3 + g5 + p) .....	5.5	5.5 Pf
Output: p to (h + k + g1 + g2 + g4 + g3 + g5) .....	13.0	8.0 Pf
Grid No. 1 to Cathode .....	3.0	3.0 Pf
Cathode to All Electrodes Except Grid No. 1 .....	20.0	15.0 Pf
Grid No. 1 to Plate .....	0.05	0.1 Pf

**RATINGS (Design Maximum Rating System)**

Plate Voltage (Max.) .....	150 Volts
Grid No. 2 and Grid No. 4 Supply Voltage (Max.) .....	150 Volts
Grid No. 2 and Grid No. 4 Voltage (Max.) .....	110 Volts
Plate Dissipation (Max.) .....	1.0 Watt
Grid No. 2 and Grid No. 4 Dissipation (Max.) .....	1.2 Watts

**CHARACTERISTICS AND TYPICAL OPERATION**

**Separate Excitation<sup>(2)</sup>**

Plate Voltage .....	100 Volts
Grid No. 2 Voltage .....	100 Volts

Grid No. 3 Voltage .....	-1.5 Volts
Grid No. 1 Resistance .....	20,000 Ohms
Grid No. 1 Current .....	0.5 Ma
Plate Current .....	2.3 Ma
Grid No. 2 Current .....	6.2 Ma
Conversion Transconductance .....	480 $\mu$ mhos
Plate Resistance (Approx.) .....	0.4 Megohm
Cathode Current .....	9 Ma
Grid No. 3 Voltage (Approx.) for $G_c = 10 \mu$ mhos .....	-21 Volts
<b>Oscillator Section Characteristics (Non-Oscillating)</b>	
Grid No. 3 Voltage .....	0 Volt
Grid No. 1 Voltage .....	0 Volt
Grid No. 2 Connected to Plate .....	100 Volts
Cathode Current .....	24 Ma
Transconductance Between Grid No. 1 and Grid No. 2 and Grid No. 4 Connected to Plate .....	7000 $\mu$ mhos
Amplification Factor Between Grid No. 1 and Grid No. 2 and Grid No. 4 Connected to Plate .....	22
Grid No. 1 Voltage (Approx.) for $I_b = 20 \mu$ a .....	-9.2 Volts

**NOTES:**

- (1) Shield No. 316 connected to cathode.
- (2) Data for self-excitation in a zero bias circuit corresponds closely to that for separate excitation.

**DETECTOR  
AF AMPLIFIER**

**18FY6A**

**Double Diode and High Mu Triode**

Construction .....	Miniature T-5½
Base .....	Button 7 Pin, E7-1
Basing .....	.7BT
Outline .....	5-2
Maximum Diameter .....	0.750 In.
Maximum Seated Height .....	1.875 In.
Maximum Overall Height .....	2.125 In.

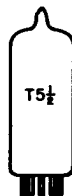
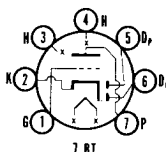

**ELECTRICAL DATA**

**HEATER OPERATION**

Heater Voltage .....	18 Volts
Heater Current .....	100 Ma
Heater Warm-up Time .....	20 Seconds
Maximum Heater-Cathode Voltage	
Heater Negative with Respect to Cathode	
Total DC and Peak .....	100 Volts
Heater Positive with Respect to Cathode	
Total DC and Peak .....	100 Volts

**DIRECT INTERELECTRODE CAPACITANCES**

	Shielded <sup>(1)</sup>	Unshielded
Grid to Plate .....	1.8	1.8 Pf
Input .....	2.4	2.4 Pf
Output .....	0.2	0.22 Pf
Grid to Diode No. 2 Plate (Max.) .....	0.2	0.2 Pf

**RATINGS (Design Maximum Rating System)**

Plate Voltage (Max.) .....	150 Volts
Plate Dissipation (Max.) .....	0.5 Watt
Positive Grid Voltage (Max.) .....	0 Volt
Diode Plate Current (Each Diode) (Max.) .....	1.0 Ma

**CHARACTERISTICS AND TYPICAL OPERATION**

**Class A1 Amplifier**

Plate Voltage .....	100 Volts
Grid Voltage .....	-1 Volt
Plate Current .....	0.6 Ma
Plate Resistance .....	77,000 Ohms
Transconductance .....	1300 $\mu$ mhos
Amplification Factor .....	100
Average Diode Current, Each Diode with 10 Volts DC Applied <sup>(2)</sup> .....	2.0 Ma

**NOTES:**

- (1) Shield No. 316 connected to Pin No. 2.
- (2) Test condition only.

# 18GD6A

# RF/IF AMPLIFIER

### Sharp Cutoff Pentode

Construction ..... Miniature T-5½  
 Base ..... Button 7 Pin, E7-1  
 Basing ..... 7BK  
 Outline ..... 5-2  
 Maximum Diameter ..... 0.750 In.  
 Maximum Seated Height ..... 1.875 In.  
 Maximum Overall Height ..... 2.125 In.

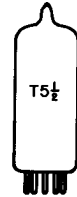
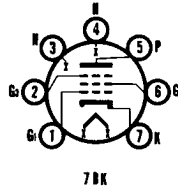

### ELECTRICAL DATA

#### HEATER OPERATION

Heater Voltage.....	18 Volts
Heater Current.....	100 Ma
Heater Warm-up Time.....	20 Seconds
Maximum Heater-Cathode Voltage	
Heater Negative with Respect to Cathode	
Total DC and Peak.....	100 Volts
Heater Positive with Respect to Cathode	
Total DC and Peak.....	100 Volts

#### DIRECT INTERELECTRODE CAPACITANCES (Shielded)<sup>(1)</sup>

Grid No. 1 to Plate (Max.).....	0.0035 Pf
Input: g1 to (h + k + g2 + g3 + IS).....	6.0 Pf
Output: p to (h + k + g2 + g3 + IS).....	5.0 Pf

#### RATINGS (Design Maximum Rating System)

Plate Voltage (Max.).....	150 Volts
Grid No. 2 Supply Voltage (Max.).....	150 Volts
Grid No. 2 Voltage.....	See Rating Chart (Gen. Info. Sec.)
Plate Dissipation (Max.).....	2.5 Watts
Grid No. 2 Dissipation (Max.).....	0.6 Watts

#### CHARACTERISTICS AND TYPICAL OPERATION

Plate Voltage.....	100 Volts
Grid No. 3 Voltage.....	Connected to Cathode at Socket
Grid No. 2 Voltage.....	100 Volts
Cathode Bias Resistor.....	150 Ohms
Plate Current.....	5 Ma
Grid No. 2 Current.....	2.0 Ma
Transconductance.....	4300 μmhos
Plate Resistance (Approx.).....	0.5 Megohm
Ec1 for Ib = 10 μa (Approx.).....	-4.7 Volts

#### NOTE:

(1) External Shield No. 316 connected to Pin No. 7 (cathode).

# 19HV8

# IF AMPLIFIER (P) AF AMPLIFIER (T)

### High Mu Triode and Sharp Cutoff Pentode

Construction ..... Miniature T-6½  
 Base ..... Button 9 Pin, E9-1  
 Basing ..... 9FA  
 Outline ..... 6-2  
 Maximum Diameter ..... 0.875 In.  
 Maximum Seated Height ..... 1.937 In.  
 Maximum Overall Height ..... 2.187 In.

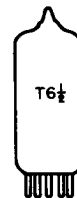
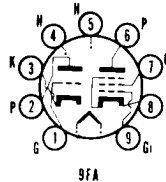

### ELECTRICAL DATA

#### HEATER OPERATION

Heater Voltage.....	18.9 Volts
Heater Current.....	150 Ma
Maximum Heater-Cathode Voltage	
Heater Negative with Respect to Cathode	
Total DC and Peak.....	200 Volts



Heater Positive with Respect to Cathode	
DC .....	100 Volts
Total DC and Peak .....	200 Volts

**DIRECT INTERELECTRODE CAPACITANCES**

	Shielded <sup>(1)</sup>	Unshielded
<b>Pentode Section</b>		
Grid No. 1 to Plate .....	—	0.016 Pf
Input: P <sub>g1</sub> to (h + P <sub>k</sub> + P <sub>g2</sub> + P <sub>g3</sub> + IS) .....	5.5	5.5 Pf
Output: P <sub>p</sub> to (h + P <sub>k</sub> + P <sub>g2</sub> + P <sub>g3</sub> + IS) .....	3.4	2.4 Pf
Heater to Cathode .....	2.8 <sup>(2)</sup>	2.8 Pf

**Triode Section**

Grid to Plate .....	0.9	0.9 Pf
Input: T <sub>g</sub> to (T <sub>k</sub> + h + P <sub>k</sub> + P <sub>g3</sub> + IS) .....	1.9	1.7 Pf
Output: T <sub>p</sub> to (T <sub>k</sub> + h + P <sub>k</sub> + P <sub>g3</sub> + IS) .....	2.6	1.7 Pf
Heater to Cathode .....	2.8 <sup>(2)</sup>	2.8 Pf

**RATINGS (Design Maximum Rating System)**

	Pentode Section	Triode Section
Plate Voltage .....	330	330 Volts
Screen Supply Voltage .....	330	— Volts
Screen Voltage .....	See Rating Chart (Gen. Info. Sec.)	
Positive DC Grid No. 1 Voltage .....	0	0 Volt
Plate Dissipation .....	3.0	0.55 Watts
Screen Dissipation .....	0.55	— Watt
Grid No. 1 Circuit Resistance		
Fixed Bias .....	0.25	0.5 Megohm
Cathode Bias .....	1.0	1.0 Megohm

**CHARACTERISTICS AND TYPICAL OPERATION**

	Pentode Section	Triode Section
Plate Voltage .....	125	100 Volts
Screen Voltage .....	125	— Volts
Grid No. 1 Voltage .....	-1.0	-1.0 Volt
Amplification Factor .....	—	70
Plate Resistance (Approx.) .....	200,000	54,000 Ohms
Transconductance .....	6500	1300 $\mu$ mhos
Plate Current .....	12	0.8 Ma
Screen Current .....	4.0	— Ma
Grid No. 1 Voltage (Approx.) I <sub>b</sub> = 50 $\mu$ a .....	—	-1.5 Volts
Grid No. 1 Voltage (Approx.) I <sub>b</sub> = 20 $\mu$ a .....	-9	— Volts

**NOTES:**

- (1) With external shield (EIA 315) connected to cathode of section under test unless otherwise indicated.
- (2) With external shield (EIA 315) connected to ground.

**OSCILLATOR and MIXER**

**19KG8**

**Medium Mu Triode and Sharp Cutoff Pentode**

Construction .....	Miniature T-6 $\frac{1}{2}$
Base .....	Button 9 Pin, E9-1
Basing .....	9LY
Outline .....	6-2
Maximum Diameter .....	0.875 In.
Maximum Seated Height .....	1.937 In.
Maximum Overall Height .....	2.187 In.

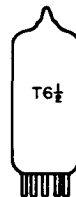
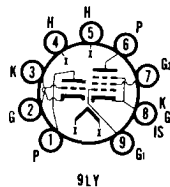

**ELECTRICAL DATA**

**HEATER OPERATION**

Heater Voltage .....	18.9 Volts
Heater Current .....	150 Ma
Maximum Heater-Cathode Voltage	
Heater Negative with Respect to Cathode	
Total DC and Peak .....	200 Volts
Heater Positive with Respect to Cathode	
DC .....	100 Volts
Total DC and Peak .....	200 Volts

**DIRECT INTERELECTRODE CAPACITANCES (Shielded)<sup>(1)</sup>**

**Pentode Section**

Grid No. 1 to Plate (Max.).....	0.01 Pf
Input: Pg1 to (h + Pk + Pg2 + Pg3 + IS) .....	5.5 Pf
Output: Pp to (h + Pk + Pg2 + Pg3 + IS) .....	3.4 Pf

**Triode Section**

Grid to Plate .....	1.7 Pf
Input: g to (h + Tk + Pk + Pg3 + IS).....	3.2 Pf
Output: p to (h + Tk + Pk + Pg3 + IS).....	2.2 Pf

**RATINGS (Design Maximum Rating System)**

	<b>Pentode Section</b>	<b>Triode Section</b>
Plate Voltage (Max.) .....	300	300 Volts
Screen Supply Voltage (Max.) .....	300	— Volts
Screen Voltage .....	See Rating Chart (Gen. Info. Sec.)	
Positive DC Grid No. 1 Voltage (Max.) .....	0	0 Volt
Plate Dissipation (Max.) .....	2.5	2.5 Watts
Screen Dissipation (Max.) .....	0.55	— Watt
Grid No. 1 Circuit Resistance		
Fixed Bias (Max.) .....	2.2	2.2 Megohms
Cathode Bias (Max.) .....	2.2	2.2 Megohms

**CHARACTERISTICS AND TYPICAL OPERATION**

	<b>Pentode Section</b>	<b>Triode Section</b>
Plate Voltage .....	125	125 Volts
Screen Voltage.....	125	— Volts
Grid No. 1 Voltage .....	-1.0	-1.0 Volt
Amplification Factor .....	—	46
Plate Resistance (Approx.) .....	200,000	5400 Ohms
Transconductance .....	7500	8500 $\mu$ mhos
Plate Current .....	12	13.5 Ma
Screen Current .....	4.0	— Ma
Grid No. 1 Voltage (Approx.)		
Ib = 10 $\mu$ a.....	-8	-8 Volts

**NOTE:**

(1) With external shield (EIA 315) connected to cathode of section under test.



**Medium Mu Triode and Semi-Remote Cutoff Pentode**

Construction .....	Miniature T-6 $\frac{1}{2}$
Base .....	Button 10 Pin, E9-1
	With Center Pin Added
Basing .....	.10H
Outline .....	6-13
Maximum Diameter .....	0.875 In.
Maximum Seated Height .....	1.940 In.
Maximum Overall Height .....	2.190 In.

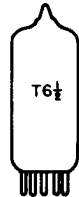
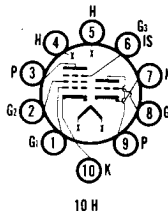

**ELECTRICAL DATA**

**HEATER OPERATION**

Heater Voltage.....	18.9 Volts
Heater Current .....	150 Ma
Heater Warm-up Time .....	17 Seconds
Maximum Heater-Cathode Voltage	
Heater Negative with Respect to Cathode	
Total DC and Peak.....	200 Volts
Heater Positive with Respect to Cathode	
DC .....	100 Volts
Total DC and Peak.....	200 Volts

**DIRECT INTERELECTRODE CAPACITANCES**

	<b>Shielded<sup>(1)</sup></b>	<b>Unshielded</b>
<b>Triode Section</b>		
Grid to Plate .....	1.7	1.7 Pf
Input: g to (h + k + Pk + IS).....	3.2	3.2 Pf
Output: p to (h + k + Pk + IS).....	1.9	1.1 Pf
Heater to Cathode .....	3.0	3.0 Pf

**Pentode Section**

Grid No. 1 to Plate (Max.).....	0.035	0.050 Pf
Input: $g_1$ to $(h + k + g_2 + Pk + IS)$ .....	5.0	5.0 Pf
Output: $p$ to $(h + k + g_2 + Pk + IS)$ .....	3.3	2.4 Pf
Heater to Cathode .....	3.0 <sup>(2)</sup>	3.0 Pf

**Coupling**

Pentode $g_1$ to Triode Plate (Max.) .....	0.030	0.035 Pf
Pentode Plate to Triode Plate (Max.) .....	0.030	0.13 Pf
Triode Grid to Pentode Plate (Max.) .....	0.002	0.009 Pf

**RATINGS (Design Maximum Rating System)**

	Triode Section	Pentode Section
Plate Voltage (Max.) .....	330	330 Volts
Grid No. 2 Supply Voltage (Max.) .....	—	330 Volts
Grid No. 2 Voltage .....	See Rating Chart (Gen. Info. Sec.)	
Plate Dissipation (Max.) .....	2.5	3.0 Watts
Grid No. 2 Dissipation (Max.) .....	—	0.55 Watt
Positive Grid No. 1 Voltage (Max.) .....	0	0 Volt
Grid No. 1 Circuit Resistance		
Fixed Bias (Max.) .....	0.5	0.25 Megohm
Self Bias (Max.) .....	1.0	1.0 Megohm

Control grid to cathode spacing in the triode section of this type is of such order to magnitude as to preclude the use of voltage between these elements of more than 100 volts dc or peak ac in commercial tube checkers and shorts indicating devices, particularly where mechanical excitation of the tube is employed.

**CHARACTERISTICS AND TYPICAL OPERATION**

	Triode Section	Pentode Section
<b>Class A1 Amplifier</b>		
Plate Voltage .....	125	125 Volts
Grid No. 2 Voltage .....	—	125 Volts
Grid No. 1 Voltage .....	-1.0	-1.0 Volt
Plate Current .....	14	12 Ma
Grid No. 2 Current .....	—	4.0 Ma
Transconductance .....	8000	6500 $\mu$ mhos
Amplification Factor .....	40	—
Plate Resistance.....	5000	200 K Ohms
Grid No. 1 Voltage for $I_b = 20 \mu a$ (Approx.) .....	-9	-9
Gm with $E_{c1} = 0 V, E_b = 100 V$ and $E_{c2} = 70 V$ .....	—	7000 $\mu$ mhos

**NOTES:**

- (1) Shield No. 315 connected to Pin No. 4.
- (2) Shield No. 315 connected to Pin No. 3.



**Twin High Mu Triode**

Construction .....	Miniature T-6½
Base .....	Button 9 Pin, E9-1
Basing .....	.9PG
Outline .....	6-2
Maximum Diameter .....	0.875 In.
Maximum Seated Height .....	1.937 In.
Maximum Overall Height .....	2.187 In.

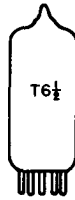
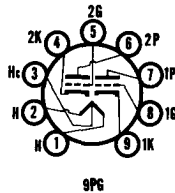

**ELECTRICAL DATA**

**HEATER OPERATION**

Heater Voltage.....	20/10 Volts
Heater Current .....	100/200 Ma
Heater Warm-up Time .....	20 Seconds
Maximum Heater-Cathode Voltage	
Heater Negative with Respect to Cathode	
Total DC and Peak.....	200 Volts
Heater Positive with Respect to Cathode	
DC .....	100 Volts
Total DC and Peak.....	200 Volts

**DIRECT INTERELECTRODE CAPACITANCES (Unshielded)**

	Section No. 1	Section No. 2
Grid to Plate .....	1.5	1.5 Pf
Grid to Cathode and Heater .....	1.6	1.6 Pf
Plate to Cathode and Heater.....	0.2	0.3 Pf

**RATINGS (Design Maximum Rating System) (Each Section)**

Plate Voltage (Max.) .....	330 Volts
Grid Voltage .....	
Negative Bias Value (Max.) .....	55 Volts
Positive Bias Value (Max.) .....	0 Volt
Plate Dissipation (Max.) .....	1.2 Watts

**CHARACTERISTICS AND TYPICAL OPERATION (Each Section)**

Plate Voltage .....	100	250 Volts
Grid Voltage .....	-1	-2 Volts
Amplification Factor .....	100	100
Plate Resistance .....	80,000	62,500 Ohms
Transconductance .....	1250	1600 $\mu$ mhos
Plate Current .....	0.5	1.2 Ma

**21HB5A**

**HORIZONTAL DEFLECTION AMPLIFIER**

**Beam Power Pentode**

Construction.....Compactron T-12  
 Base ..... Button 12 Pin, E12-74  
 Basing ..... 12BJ  
 Outline ..... 12-58  
 Maximum Diameter ..... 1.563 In.  
 Maximum Seated Height ..... 3.000 In.  
 Maximum Overall Height ..... 3.375 In.  
 The 21HB5A is identical to the 21HB5 except for  $R_p = 9900$  Ohms,  $G_m = 9000$   $\mu$ mhos,  $I_b = 46$  Ma,  $I_{c2} = 1.8$  Ma,  $E_{c1}$  (for  $I_b = 1$  Ma)  $-32$  V and Triode amplification factor = 4.8.

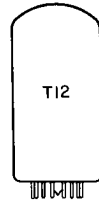
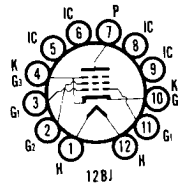

**21KQ6**

29KQ6

**HORIZONTAL DEFLECTION AMPLIFIER**

**Beam Power Pentode**

Construction ..... T-9  
 Base ..... Button 9 Pin, E9-23  
 Top Cap ..... C1-1  
 Basing ..... 9RJ  
 Outline .....  
 Maximum Diameter ..... 1.188 In.  
 Maximum Seated Height ..... 3.760 In.  
 Maximum Overall Height ..... 4.133 In.

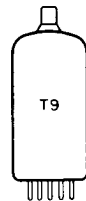
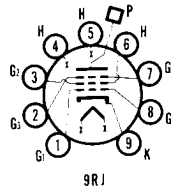

**ELECTRICAL DATA HEATER OPERATION**

Heater Voltage .....	<b>29KQ6</b>	<b>21KQ6</b>
Heater Current .....	29	21.5 Volts
Maximum Heater-Cathode Voltage .....	300	450 Ma
Heater Negative with Respect to Cathode		
DC .....		240 Volts
Total DC and Peak .....		240 Volts
Heater Positive with Respect to Cathode		
DC .....		240 Volts
Total DC and Peak .....		240 Volts

**DIRECT INTERELECTRODE CAPACITANCES (Unshielded)**

Grid No. 1 to Plate .....	1.5 Pf
Input: $g_1$ to $(h + k + g_2 + g_3)$ .....	27 Pf
Output: $p$ to $(h + k + g_2 + g_3)$ .....	11 Pf
Grid No. 1 to Heater .....	0.12 Pf

**RATINGS (Design Maximum Rating System)**

Plate Voltage (Max.) .....	275 Volts
Plate Voltage without Plate Current (Max.) .....	600 Volts

Peak Positive Pulse Plate Voltage (Max.) <sup>(1)</sup> .....	6500 Volts
Peak Negative Pulse Plate Voltage (Max.) <sup>(1)</sup> .....	1650 Volts
Grid No. 3 Voltage (Max.) .....	70 Volts
Grid No. 2 Voltage (Max.) .....	275 Volts
Grid No. 2 Voltage without Grid No. 2 Current (Max.) .....	600 Volts
Peak Negative Pulse Grid No. 1 Voltage (Max.) .....	330 Volts
Plate Dissipation (Max.) .....	17 Watts
Grid No. 2 Dissipation .....	See Rating Chart (Gen. Info. Sec.)
Cathode Current DC (Max.) .....	275 Ma
Grid No. 1 Circuit Resistance (Max.) .....	0.5 Megohm
Grid No. 1 Circuit Resistance for Horizontal Deflection Amplifier Circuit Only (Max.) .....	2.2 Megohms

**CHARACTERISTICS AND TYPICAL OPERATION**

Plate Voltage .....	40	50 Volts
Grid No. 3 Voltage <sup>(3)</sup> .....	0	0 Volt
Grid No. 2 Voltage .....	135	200 Volts
Grid No. 2 Circuit Resistance <sup>(2)</sup> .....	820	0 Ohms
Grid No. 1 Voltage .....	0	-12 Volts
Plate Current .....	450	550 <sup>(4)</sup> Ma
Grid No. 2 Current .....	35	50 <sup>(4)</sup> Ma

**NOTES:**

- (1) For application in horizontal deflection amplifiers circuits where the maximum pulse duration is 22% of a cycle with a maximum of 18  $\mu$ sec.
- (2) To prevent an excessive maximum grid No. 2 dissipation value, during the heating-up period the following minimum values of grid No. 2 circuit resistance are required:
 

Grid No. 2 Supply Voltage (Volts)	Grid No. 2 Circuit Resistance (Ohms)
135	820
170	1200
230	2200
- (3) In case that an optimum suppression of Barkhausen oscillations and/or snivets is required the Grid No. 3 may be connected to a positive voltage of about 15 to 40 volts. It should, however, be noted that the current to Grid No. 3 is dependent upon the plate load of tube and may vary between 1 and 4 Ma.
- (4) This value can be measured by a method involving a recurrent waveform such that the maximum ratings of the tube will not be exceeded.

**DAMPER**

**22BW3**  
6BW3, 17BW3

**Heater-Cathode Diode**

Construction..... Compactron T-9  
 Base ..... Button 12 Pin E12-70  
 Basing ..... 12FX  
 Outline ..... 9-60  
 Maximum Diameter ..... 1.188 In.  
 Maximum Seated Height ..... 2.500 In.  
 Maximum Overall Height ..... 2.875 In.

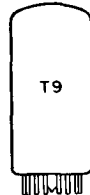
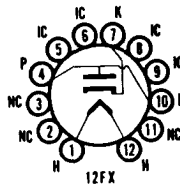

**ELECTRICAL DATA**

**HEATER OPERATION**

	6BW3	17BW3	22BW3
Heater Voltage.....	6.3	16.8	22.4 Volts
Heater Current .....	1600	600	450 Ma
Heater Warm-up Time .....	—	11	11 Seconds
Maximum Heater-Cathode Voltage	Heater Negative with Respect to Cathode		
DC .....	900 Volts		
Total DC and Peak.....	5000 Volts		
Heater Positive with Respect to Cathode	DC .....		
DC .....	100 Volts		
Total DC and Peak.....	300 Volts		

**DIRECT INTERELECTRODE CAPACITANCES (Unshielded)**

Heater to Cathode .....	3.8 Pf
Plate to Cathode and Heater.....	6.0 Pf
Cathode to Plate and Heater.....	8.5 Pf

**RATINGS (Design Maximum Rating System)**

**Damper Service**

Peak Inverse Plate Voltage (Max.) <sup>(1)</sup> .....	5000 Volts
Plate Dissipation (Max.) .....	6.5 Watts
Steady State Peak Current (Max.) .....	1100 Ma
DC Plate Current (Max.) .....	175 Ma

**NOTE:**

(1) For operation in a 525 line, 30 frame system as described in "Standards of Good Engineering Practice for Television Broadcast Stations; Federal Communications Commission," the duty cycle of the voltage pulse must not exceed 15% of one horizontal scanning cycle.

**2379**

**VERTICAL DEFLECTION AMP. (P)  
VERTICAL DEFLECTION OSC. (T)  
GENERAL PURPOSE AMPLIFIER (T)**

**Medium Mu Triode, High Mu Triode  
and Beam Power Pentode**

Construction..... Compactron T-9  
Base ..... Button 12 Pin, E12-70  
Basing ..... 12GZ  
Outline ..... 9-58  
Maximum Diameter ..... 1.188 In.  
Maximum Seated Height ..... 2.000 In.  
Maximum Overall Height ..... 2.375 In.

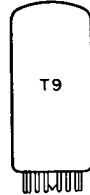
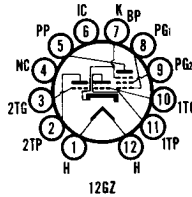

**ELECTRICAL DATA**

**HEATER OPERATION**

Heater Voltage.....	23 Volts
Heater Current.....	450 Ma
Heater Warm-up Time.....	11 Seconds
Maximum Heater-Cathode Voltage	
Heater Negative with Respect to Cathode	
Total DC and Peak.....	200 Volts
Heater Positive with Respect to Cathode	
DC.....	100 Volts
Total DC and Peak.....	200 Volts

**DIRECT INTERELECTRODE CAPACITANCES (Unshielded)**

**Triode (Section 1)**

Grid to Plate.....	3.0 Pf
Input: 1Tg to (h + k + Pbp).....	3.0 Pf
Output: 1Tp to (h + k + Pbp).....	0.4 Pf

**Triode (Section 2)**

Grid to Plate.....	3.8 Pf
Input: 2Tg to (h + k + Pbp).....	2.0 Pf
Output: 2Tp to (h + k + Pbp).....	0.44 Pf

**RATINGS (Design Maximum Rating System)**

**Pentode Section—Vertical Deflection Amplifier Service<sup>(1)</sup>**

DC Plate Voltage (Max.).....	250 Volts
Peak Pulse Plate Voltage (Max.).....	2000 Volts
Screen Voltage (Max.).....	200 Volts
Peak Negative Grid No. 1 Voltage (Max.).....	150 Volts
Plate Dissipation (Max.).....	7.0 Watts
Screen Dissipation (Max.).....	1.8 Watts
Total DC Plate and Screen Current (Max.).....	70 Ma
Total Peak Plate and Screen Current (Max.).....	245 Ma
Grid No. 1 Circuit Resistance	
Fixed Bias.....	1.0 Megohm

**Triode Section 1**

Plate Voltage (Max.).....	330 Volts
Positive DC Grid Voltage (Max.).....	0 Volt
Plate Dissipation (Max.).....	1.25 Watts
Grid Circuit Resistance	
Fixed Bias (Max.).....	0.5 Megohm

**Triode Section 2—Vertical Oscillator Service<sup>(1)</sup>**

DC Plate Voltage (Max.).....	250 Volts
Peak Negative Grid Voltage (Max.).....	400 Volts
Plate Dissipation (Max.).....	1.0 Watt
DC Plate Current (Max.).....	20 Ma
Peak Plate Current (Max.).....	70 Ma
Grid Circuit Resistance	
Fixed Bias (Max.).....	1.0 Megohm

**CHARACTERISTICS AND TYPICAL OPERATION**

**Pentode Section**

Plate Voltage.....	45	120 Volts
Screen Voltage.....	110	110 Volts

Grid No. 1 Voltage .....	0 <sup>(2)</sup>	-8.0 Volts
Plate Resistance (Approx.) .....	—	11,700 $\mu$ mhos
Transconductance .....	—	7100 Ma
Plate Current .....	122	46 Ma
Screen Current .....	16.5	3.5 Ma
Grid No. 1 Voltage (Approx.) I <sub>b</sub> = 100 $\mu$ a .....	—	-25 Volts
<b>Triode Section 1</b>		
Plate Voltage .....		150 Volts
Grid Voltage .....		-2.0 Volts
Amplification Factor .....		43
Plate Resistance (Approx.) .....		11,000 Ohms
Transconductance .....		3900 $\mu$ mhos
Plate Current .....		5.4 Ma
Grid Voltage (Approx.) I <sub>b</sub> = 10 $\mu$ a .....		-5.7 Volts
<b>Triode Section 2</b>		
Plate Voltage .....		150 Volts
Grid Voltage .....		-5.0 Volts
Amplification Factor .....		20
Plate Resistance (Approx.) .....		8500 Ohms
Transconductance .....		2350 $\mu$ mhos
Plate Current .....		5.5 Ma
Grid Voltage (Approx.) I <sub>b</sub> = 10 $\mu$ a .....		-11 Volts

**NOTES:**

- (1) For operation in a 525 line, 30 frame system as described in "Standards of Good Engineering Practice for Television Broadcast Stations; Federal Communications Commission," the duty cycle of the voltage pulse must not exceed 15% of one horizontal scanning cycle.
- (2) Applied for short interval (two seconds maximum) so as not to damage tube.

**AUDIO POWER AMPLIFIER**

**32E5A**

**Beam Power Pentode**

Construction .....	Miniature T-5½
Base .....	Button 7 Pin, E7-1
Basing .....	.7CV
Outline .....	.5-3
Maximum Diameter .....	0.750 In.
Maximum Seated Height .....	2.375 In.
Maximum Overall Height .....	2.625 In.

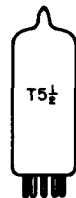
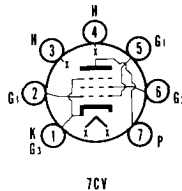

**ELECTRICAL DATA**

**HEATER OPERATION**

Heater Voltage .....	32 Volts
Heater Current .....	100 Ma
Heater Warm-up Time .....	20 Seconds
Maximum Heater-Cathode Voltage	
Heater Negative with Respect to Cathode	
Total DC and Peak .....	200 Volts
Heater Positive with Respect to Cathode	
DC .....	100 Volts
Total DC and Peak .....	200 Volts

**DIRECT INTERELECTRODE CAPACITANCES (Unshielded)**

Grid No. 1 to Plate .....	0.6 Pf
Input: g to (h + k + g <sub>2</sub> + g <sub>3</sub> ) .....	12 Pf
Output: p to (h + k + g <sub>2</sub> + g <sub>3</sub> ) .....	6.0 Pf

**RATINGS (Design Maximum Rating System)**

Plate Voltage (Max.) .....	150 Volts
Grid No. 2 Voltage (Max.) .....	130 Volts
Plate Dissipation (Max.) .....	5.4 Watts
Grid No. 2 Dissipation (Max.) .....	1.2 Watts
Grid No. 1 Circuit Resistance	
Fixed Bias (Max.) .....	0.1 Megohm
Cathode Bias (Max.) .....	0.5 Megohm

**CHARACTERISTICS AND TYPICAL OPERATION**

**Class A1 Amplifier**

Plate Voltage .....	110 Volts
Grid No. 2 Voltage .....	110 Volts
Grid No. 1 Voltage .....	-7.5 Volts
Peak AF Grid No. 1 Voltage .....	7.5 Volts
Zero-Signal Plate Current .....	30 Ma

Zero-Signal Grid No. 2 Current.....	2.8 Ma
Transconductance .....	5500 $\mu$ mhos
Plate Resistance (Approx.) .....	21,000 Ohms
Load Resistance .....	2800 Ohms
Maximum Signal Power Output .....	1.2 Watts
Total Harmonic Distortion (Approx.) .....	10 Percent

# 33GT7

## DAMPER HORIZONTAL DEFLECTION AMPLIFIER

### Diode and Beam Power Pentode

Construction..... Compactron T-12  
 Base ..... Button 12 Pin, E12-74  
 Basing ..... 12FC  
 Outline ..... 12-56  
 Maximum Diameter ..... 1.562 In.  
 Maximum Seated Height ..... 2.500 In.  
 Maximum Overall Height ..... 2.875 In.

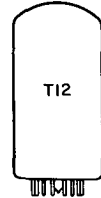
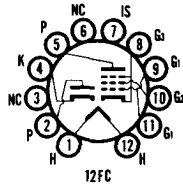

### ELECTRICAL DATA HEATER OPERATION

Heater Voltage.....	33.6 Volts
Heater Current .....	450 Ma
Heater Warm-up Time .....	11 Seconds
Maximum Heater-Cathode Voltage .....	<b>Pentode</b>
Heater Negative with Respect to Cathode	<b>Diode</b>
DC .....	—
Total DC and Peak.....	200
Heater Positive with Respect to Cathode	
DC .....	100
Total DC and Peak.....	200

### DIRECT INTERELECTRODE CAPACITANCES (Unshielded)

<b>Diode Section</b>	
Cathode to Plate and Heater k to (p + h) .....	8.5 Pf
Plate to Cathode and Heater p to (k + h) .....	5.5 Pf
Heater to Cathode (h to k) .....	3.2 Pf
<b>Pentode Section</b>	
Grid No. 1 to Plate: (g1 to p) .....	0.2 Pf
Input: g1 to (h + k + g2 + bp).....	17 Pf
Output: p to (h + k + g2 + bp).....	7.0 Pf

### RATINGS (Design Maximum Rating System)

<b>Pentode Section—Horizontal Deflection Amplifier Service<sup>(1)</sup></b>	
DC Plate Supply Voltage (Boost + DC Power Supply) (Max.) .....	400 Volts
Peak Positive Pulse Plate Voltage (Max.) .....	3500 Volts
Peak Negative Pulse Plate Voltage (Max.) .....	0 Volt
Screen Voltage (Max.) .....	150 Volts
Negative DC Grid No. 1 Voltage (Max.).....	55 Volts
Peak Negative Grid No. 1 Voltage (Max.) .....	330 Volts
Plate Dissipation (Max.) <sup>(2)</sup> .....	9.0 Watts
Screen Dissipation (Max.) .....	2.5 Watts
DC Cathode Current (Max.) .....	140 Ma
Peak Cathode Current (Max.) .....	490 Ma
Grid No. 1 Circuit Resistance (Max.) .....	1.0 Megohm
<b>Diode Section—TV Damper Service</b>	
Peak Inverse Plate Voltage (Max.) .....	2500 Volts
Plate Dissipation (Max.) .....	3.5 Watts
Steady State Peak Plate Current (Max.) .....	750 Ma
DC Output Current (Max.) .....	125 Ma
Bulb Temperature at Hottest Point (Max.) .....	220 °C

### CHARACTERISTICS AND TYPICAL OPERATION

<b>Pentode Section</b>			
Plate Voltage .....	3500	60	130 Volts
Screen Voltage.....	130	130	130 Volts
Grid No. 1 Voltage .....	—	0 <sup>(3)</sup>	-22.5 Volts
Plate Resistance (Approx.) .....	—	—	10,000 Ohms
Transconductance .....	—	—	6500 $\mu$ mhos
Plate Current .....	—	320	48 Ma
Screen Current .....	—	22	2.9 Ma
Grid No. 1 Voltage (Approx.) Ib = 1.0 Ma .....	-60	—	-40 Volts
Triode Amplification Factor <sup>(4)</sup> .....	—	—	4.0



**Diode Section**

Tube Voltage Drop

$I_b = 250 \text{ Ma DC}$  ..... 21 Volts

**NOTES:**

- (1) For operation in a 525 line, 30 frame system as described in "Standards of Good Engineering Practice for Television Broadcast Stations; Federal Communications Commission," the duty cycle of the voltage pulse must not exceed 15% of one horizontal scanning cycle.
- (2) In stages operating with grid leak bias, an adequate cathode bias resistor or other suitable means is required to protect the tube in the absence of excitation.
- (3) Applied for short interval (two seconds maximum) so as not to damage tube.
- (4) Triode connection (screen tied to plate) with  $E_b = E_{c2} = 130 \text{ volts}$  and  $E_{c1} = -22.5 \text{ volts}$ .

**DAMPER  
HORIZONTAL DEFLECTION  
AMPLIFIER**

**33GY7A**

**Diode and Beam Power Pentode**

Construction.....Compactron T-12  
 Base .....Button 12 Pin, E12-74  
 Basing .....12FN  
 Outline .....12-56  
 Maximum Diameter .....1.563 In.  
 Maximum Seated Height .....2.500 In.  
 Maximum Overall Height .....2.875 In.

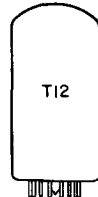
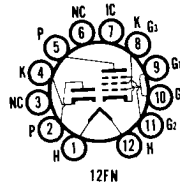

**ELECTRICAL DATA  
HEATER OPERATION**

Heater Voltage.....	33.6 Volts
Heater Current.....	450 Ma
Heater Warm-up Time.....	11 Seconds
Maximum Heater-Cathode Voltage.....	<b>Pentode</b>
Heater Negative with Respect to Cathode	<b>Diode</b>
DC.....	—
Total DC and Peak.....	400 Volts
Heater Positive with Respect to Cathode	4200 Volts
DC.....	100
Total DC and Peak.....	100 Volts
	200
	200 Volts

**DIRECT INTERELECTRODE CAPACITANCES (Unshielded)**

**Diode Section**

Cathode to Plate and Heater: $k$ to $(p + h)$ .....	8.5 Pf
Plate to Cathode and Heater: $p$ to $(k + h)$ .....	5.2 Pf
Heater to Cathode: $(h$ to $k)$ .....	3.2 Pf

**Pentode Section**

Grid No. 1 to Plate: $(g1$ to $p)$ .....	0.2 Pf
Input: $g1$ to $(h + k + g2 + bp)$ .....	17 Pf
Output: $p$ to $(h + k + g2 + bp)$ .....	7.0 Pf

**RATINGS (Design Maximum Rating System)**

**Horizontal-Deflection Amplifier Service<sup>(1)</sup>**

DC Plate Supply Voltage (Boost + DC Power Supply) (Max.).....	<b>Pentode</b>
Peak Positive Pulse Plate Voltage (Max.).....	<b>Section</b>
Peak Negative Pulse Plate Voltage (Max.).....	400 Volts
Screen Voltage (Max.).....	5000 Volts
Negative DC Grid No. 1 Voltage (Max.).....	0 Volt
Peak Negative Grid No. 1 Voltage (Max.).....	150 Volts
Plate Dissipation (Max.).....	55 Volts
Screen Dissipation (Max.) <sup>(2)</sup> .....	330 Volts
DC Cathode Current (Max.).....	9.0 Watts
Peak Cathode Current (Max.).....	3.0 Watts
Grid No. 1 Circuit Resistance (Max.).....	155 Ma
	540 Ma
	1.0 Megohm

**TV Damper Service<sup>(1)</sup>**

Peak Inverse Plate Voltage.....	<b>Diode</b>
Plate Dissipation.....	<b>Section</b>
Steady State Peak Plate Current.....	4200 Volts
DC Output Current.....	3.8 Watts
Bulb Temperature at Hottest Point.....	810 Ma
	135 Ma
	200 °C

**CHARACTERISTICS AND TYPICAL OPERATION**

**Pentode Section**

Plate Voltage .....	5000	60	130 Volts
Screen Voltage .....	130	130	130 Volts
Grid No. 1 Voltage .....	—	0	-22.5 Volts
Plate Resistance (Approx.) .....	—	—	10,000 Ohms
Transconductance .....	—	—	6500 $\mu$ mhos
Plate Current .....	—	320	48 Ma
Screen Current .....	—	22	2.9 Ma
Grid No. 1 Voltage (Approx.) I <sub>b</sub> = 1.0 Ma .....	-80	—	-40 Volts
Triode Amplification Factor <sup>(3)</sup> .....	—	—	4.0

**Diode Section**

Tube Voltage Drop I <sub>b</sub> = 250 Ma DC .....	—	—	21 Volts
---	---	---	----------

**NOTES:**

- (1) For operation in a 525 line, 30 frame system as described in "Standards of Good Engineering Practice for Television Broadcast Stations; Federal Communications Commission," the duty cycle of the voltage pulse must not exceed 15% of one horizontal scanning cycle.
- (2) In stages operating with grid leak bias, an adequate cathode bias resistor or other suitable means is required to protect the tube in the absence of excitation.
- (3) Amplification factor with tube operating as a triode with 130 volts on the plate and Grid No. 2 and -22.5 volts on Grid No. 1.



**Beam Power Pentode**

Construction .....	Compactron T-12
Base .....	Button 12 Pin, E12-74
Basing .....	.12FK
Outline .....	.12-58
Maximum Diameter .....	1.562 In.
Maximum Seated Height .....	3.000 In.
Maximum Overall Height .....	3.375 In.

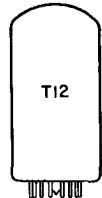
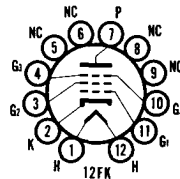

**ELECTRICAL DATA**

**HEATER OPERATION**

Heater Voltage .....	33 Volts
Heater Current .....	300 Ma
Heater Warm-up Time .....	11 Seconds
Maximum Heater-Cathode Voltage	
Heater Negative with Respect to Cathode	
Total DC and Peak .....	200 Volts
Heater Positive with Respect to Cathode	
DC .....	100 Volts
Total DC and Peak .....	200 Volts

**DIRECT INTERELECTRODE CAPACITANCES (Unshielded)**

Grid No. 1 to Plate .....	0.4 Pf
Input .....	22 Pf
Output .....	9.0 Pf

**RATINGS (Design Maximum Rating System)**

**Horizontal Deflection Amplifier<sup>(1)</sup>**

DC Plate Supply Voltage (Boost + DC Power Supply) (Max.) .....	770 Volts
Peak Positive Pulse Plate Voltage (Max.) .....	6000 Volts
Peak Negative Pulse Plate Voltage (Max.) .....	1500 Volts
Positive DC Beam Plate Voltage (Max.) .....	70 Volts
Plate Dissipation (Max.) .....	18 Watts
Negative DC Grid No. 1 Voltage .....	55 Volts
Peak Negative Grid No. 1 Voltage (Max.) .....	330 Volts
Grid No. 2 Voltage (Max.) .....	220 Volts
Grid No. 2 Dissipation (Max.) <sup>(2)</sup> .....	3.5 Watts
Average Cathode Current (Max.) .....	230 Ma
Peak Cathode Current (Max.) .....	800 Ma
Grid No. 1 Circuit Resistance (Max.) .....	1.0 Megohm
Bulb Temperature (at Hottest Point) (Max.) .....	220 °C

**CHARACTERISTICS AND TYPICAL OPERATION**

Plate Voltage .....	130 Volts
Grid No. 2 Voltage .....	130 Volts
Grid No. 1 Voltage .....	-20 Volts

Plate Current .....	50 Ma
Grid No. 2 Current .....	1.75 Ma
Transconductance .....	9100 $\mu$ mhos
Plate Resistance.....	11,000 Ohms
Amplification Factor <sup>(3)</sup> .....	4.7
Ec1 for Ib = 1.0 Ma (Approx.) .....	-33 Volts

**INSTANTANEOUS PLATE KNEE VALUES**

Eb = 60 V; Ec2 = 130 V and Ec1 = 0 V  
 Ib = 410 Ma, and Ic2 = 24 Ma

**NOTES:**

- (1) For operation in a 525 line, 30 frame system as described in "Standards of Good Engineering Practice for Television Broadcast Stations; Federal Communications Commission," the duty cycle of the voltage pulse must not exceed 15% of one horizontal scanning cycle.
- (2) In stages operating with grid leak bias, an adequate cathode bias resistor or other suitable means is required to protect the tube in the absence of excitation.
- (3) Amplification factor with tube operation as a triode with 130 volts on the plate and Grid No. 2 and -20 volts on Grid No. 1.

**AUDIO OUTPUT AMPLIFIER**

**34GD5A**

**Beam Power Pentode**

Construction .....	Miniature T-5½
Base .....	Button 7 Pin, E7-1
Basing .....	.7CV
Outline .....	5-3
Maximum Diameter .....	0.750 In.
Maximum Seated Height .....	2.375 In.
Maximum Overall Height .....	2.625 In.

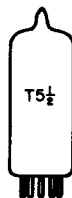
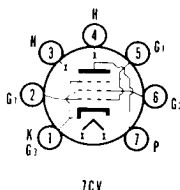

**ELECTRICAL DATA**

**HEATER OPERATION**

Heater Voltage .....	34 Volts
Heater Current .....	100 Ma
Heater Warm-up Time .....	20 Seconds
Maximum Heater-Cathode Voltage	
Heater Negative with Respect to Cathode	
Total DC and Peak .....	200 Volts
Heater Positive with Respect to Cathode	
DC .....	100 Volts
Total DC and Peak .....	200 Volts

**DIRECT INTERELECTRODE CAPACITANCES (Unshielded)**

Grid No. 1 to Plate .....	0.6 Pf
Input: g1 to (h + k + g2 + g3) .....	12 Pf
Output: p to (h + k + g2 + g3) .....	9.0 Pf

**RATINGS (Design Maximum Rating System)**

Plate Voltage (Max.) .....	150 Volts
Grid No. 2 Voltage (Max.) .....	130 Volts
Plate Dissipation (Max.) .....	5.0 Watts
Grid No. 2 Dissipation (Max.) .....	1.1 Watts
Grid No. 1 Circuit Resistance	
Fixed Bias (Max.) .....	0.1 Megohm
Cathode Bias (Max.) .....	0.5 Megohm

**CHARACTERISTICS AND TYPICAL OPERATION**

**Class A1 Amplifier**

Plate Voltage .....	110 Volts
Grid No. 2 Voltage .....	110 Volts
Grid No. 1 Voltage .....	-7.5 Volts
Peak AF Grid No. 1 Voltage .....	7.5 Volts
Zero-Signal Plate Current .....	35 Ma
Zero-Signal Grid No. 2 Current .....	3.0 Ma
Transconductance .....	5700 $\mu$ mhos
Plate Resistance (Approx.) .....	13,000 Ohms
Load Resistance .....	2500 Ohms
Maximum Signal Power Output .....	1.4 Watts
Total Harmonic Distortion (Approx.) .....	10 Percent

# 35C5

11C5

## AUDIO POWER AMPLIFIER

**Beam Power Pentode**

Construction ..... Miniature T-5½  
 Base ..... Button 7 Pin, E7-1  
 Basing ..... 7CV  
 Outline ..... 5-3  
 Maximum Diameter ..... 0.750 In.  
 Maximum Seated Height ..... 2.375 In.  
 Maximum Overall Height ..... 2.625 In.

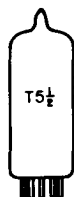
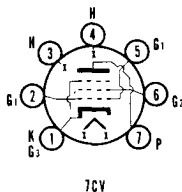

**ELECTRICAL DATA  
 HEATER OPERATION**

Heater Voltage.....	11C5	<b>35C5</b>
Heater Current.....	11.6	35 Volts
Maximum Heater-Cathode Voltage.....	450	150 Ma
	200	200 Volts
<b>DIRECT INTERELECTRODE CAPACITANCES (Unshielded)</b>		
Grid No. 1 to Plate.....		0.6 Pf
Input: g1 to (h + k + g2 + g3).....		12 Pf
Output: p to (h + k + g2 + g3).....		9 Pf
<b>RATINGS (Design Maximum Rating System)</b>		
Plate Voltage (Max.).....		150 Volts
Screen Voltage (Max.).....		130 Volts
Plate Dissipation (Max.).....		5.2 Watts
Screen Dissipation (Max.).....		1.1 Watts
Control Grid Circuit Resistance		
Fixed Bias (Max.).....		0.1 Megohm
Cathode Bias (Max.).....		0.5 Megohm

**CHARACTERISTICS AND TYPICAL OPERATION**

**Class A1 Amplifier**

Plate Voltage.....	110 Volts
Screen Voltage.....	110 Volts
Control Grid Voltage.....	-7.5 Volts
Peak AF Control Grid Voltage.....	7.5 Volts
Zero Signal Plate Current.....	40 Ma
Maximum Signal Plate Current.....	41 Ma
Zero Signal Screen Current.....	3 Ma
Maximum Signal Screen Current.....	7 Ma
Plate Resistance (Approx.).....	13,000 Ohms
Transconductance.....	5800 μmhos
Load Resistance.....	2500 Ohms
Maximum Signal Power Output.....	1.5 Watts
Total Harmonic Distortion (Approx.).....	10 Percent

# 35W4

## HALF WAVE RECTIFIER

**Heater-Cathode Diode**

Construction ..... Miniature T-5½  
 Base ..... Button 7 Pin, E9-1  
 Basing ..... 5BQ  
 Outline ..... 5-3  
 Maximum Diameter ..... 0.750 In.  
 Maximum Seated Height ..... 2.375 In.  
 Maximum Overall Height ..... 2.625 In.

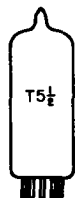
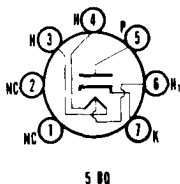

**ELECTRICAL DATA  
 HEATER OPERATION**

Heater Voltage.....	32 Volts
Heater Current.....	150 Ma
Maximum Heater-Cathode Voltage.....	360 Volts
<b>RATINGS (Design Maximum Rating System)</b>	
Peak Inverse Plate Voltage (Max.).....	360 Volts

Peak Plate Current (Max.) .....	660 Ma
DC Output Current with Panel Lamp	
No Shunting Resistor (Max.).....	66 Ma
With Shunting Resistor (Max.).....	100 Ma
Without Panel Lamp (Max.).....	110 Ma
Panel Lamp Section Voltage (Panel Lamp Open) (Max.) .....	17 Volts
Tube Voltage Drop at 200 Ma Plate Current (Max.) .....	18 Volts

**CHARACTERISTICS AND TYPICAL OPERATION (Half-Wave Rectifier Service)**

**Capacitor Input to Filter**

**Panel Lamps No. 40 or 47 and C Input = 40  $\mu$ f**

Heater Voltage.....	32	32	32	32 Volts
Heater Current .....	150	150	150	150 Ma
Plate Supply (RMS).....	117	117	117	117 Volts
Minimum Effective Plate Supply Impedance .....	11	15	15	15 Ohms
Panel Lamp Shunting Resistor .....	—	300	150	100 Ohms
DC Output Current.....	60	70	80	90 Ma

**Without Panel Lamp and C Input = 40  $\mu$ f**

Heater Voltage.....				35 Volts
Heater Current .....				150 Ma
Plate Supply Voltage (RMS) .....				117 Volts
Minimum Effective Plate Supply Impedance .....				15 Ohms
DC Output Current.....				100 Ma
Maximum Value of Panel Lamp Shunting Resistor				
70 Ma Output .....				800 Ohms
80 Ma Output .....				400 Ohms
90 Ma Output .....				250 Ohms

**HALF-WAVE POWER RECTIFIER**

**35Z5GT**

**Heater-Cathode Diode**

Construction .....	Octal T-9
Base .....	Octal 6 Pin, B6-8, or B6-60
Basing .....	.6AD
Outline .....	9-11 or 9-41
Maximum Diameter .....	1.188 In.
Maximum Seated Height .....	2.750 In.
Maximum Overall Height .....	3.312 In.

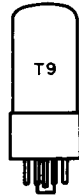
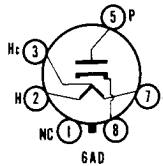

**ELECTRICAL DATA**

**HEATER OPERATION**

	Without Panel Lamp		With No. 40 or 47 Panel Lamp	
Heater Voltage				
Entire Heater (Pins 2 and 7) .....	35		35 Volts	
Panel Lamp Section (Pins 2 and 3).....	7.5		5.5 Volts	
Heater Current				
Between Pins 2 and 7 .....	150		— Ma	
Between Pins 3 and 7 .....	—		150 Ma	
Maximum Heater-Cathode Voltage (DC) .....	350		350 Volts	

**CHARACTERISTICS AND TYPICAL OPERATION**

**Half-Wave Rectifier with No. 40 or 47 Panel Lamp Capacitor Input to Filter**

AC Plate Supply Voltage (RMS).....	117	117	117	117	235 Volts
Filter Input Capacitance .....	40	40	40	40	40 Pf
Minimum Total Effective					
Plate Supply Impedance.....	15	15	15	15	100 Ohms
Panel Light Shunting Resistor .....	—	300	150	100	— Ohms
DC Output Current.....	60	70	80	90	60 Ma

**Half-Wave Rectifier Without Panel Lamp Capacitor Input to Filter**

AC Plate Supply Voltage (RMS).....		117	235 Volts
Filter Input Capacitance .....		40	40 Pf
Minimum Total Effective Plate Supply Impedance .....		15	100 Ohms
DC Output Voltage at Input to Filter (Approx.)			
At 50 Ma (Half Load) .....		140	280 Volts
At 100 Ma (Full Load) .....		120	235 Volts
Percent Regulation .....		14	16 Percent
DC Output Current.....		100	100 Ma

**NOTE:**

(1) Plate Current must not flow through tap section (Pins 2 and 3).

# 36AM3B

# HALF-WAVE RECTIFIER

### Heater Cathode Diode

Construction ..... Miniature T-5½  
 Base ..... Button 7 Pin, E7-1  
 Basing ..... 5BQ  
 Outline ..... 5-3  
 Maximum Diameter ..... 0.750 In.  
 Maximum Seated Height ..... 2.375 In.  
 Maximum Overall Height ..... 2.625 In.

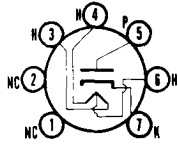

5 BQ

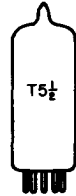

### ELECTRICAL DATA

#### HEATER OPERATION

Heater Voltage (Pins 3 and 4) <sup>(1)</sup> .....	36 Volts
Heater Voltage (Pins 3 and 6) <sup>(1)</sup> .....	32 Volts
Heater Current .....	100 Ma
Heater Warm-up Time (Pins 3 and 4) .....	20 Seconds
Maximum Heater Cathode Voltage	
Heater Negative with Respect to Cathode	
Total DC and Peak .....	350 Volts
Heater Positive with Respect to Cathode	
DC .....	100 Volts
Total DC and Peak .....	200 Volts

#### RATINGS (Design Maximum Rating System)

Peak Inverse Voltage (Max.) .....	365 Volts
Steady State Peak Plate Current (Max.) .....	580 Ma
Voltage (RMS) of Panel Lamp Section	
When Panel Lamp Fails (Max.) .....	10 Volts
DC Output Current	
Without Panel Lamp Per Circuit 1 (Max.) .....	82 Ma
With Panel Lamp Per Circuit 2 and No Shunting Resistor (Max.) .....	68 Ma
With Panel Lamp Per Circuit 2 and Shunting Resistor (Max.) .....	82 Ma

#### CHARACTERISTICS AND TYPICAL OPERATION

Tube Voltage Drop with Plate Current = 150 Ma .....	16 Volts
---	----------

#### NOTE:

(1) The heater section between pins 3 and 6 is the tube heater proper. The section between pins 4 and 6 may be used either as a limiting resistance in the rectifier plate circuit, or as a panel lamp shunt.

#### CIRCUIT 1

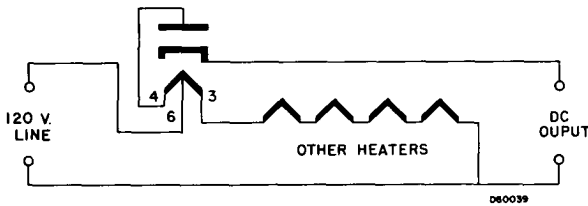

D60039

#### CIRCUIT 2

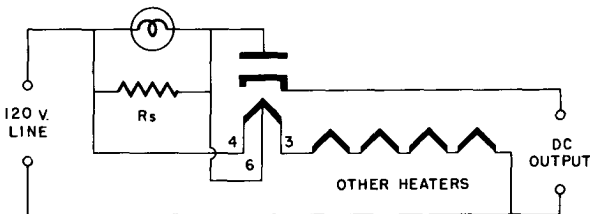

D60040

**AUDIO POWER AMPLIFIER**

**50B5**

**Beam Power Pentode**

Construction ..... Miniature T-5½  
 Base ..... Button 7 Pin, E7-1  
 Basing ..... .7BZ  
 Outline ..... 5-3  
 Maximum Diameter ..... 0.750 In.  
 Maximum Seated Height ..... 2.375 In.  
 Maximum Overall Height ..... 2.625 In.

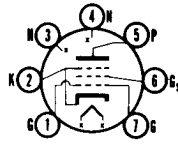

7BZ

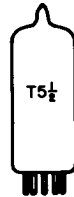

**ELECTRICAL DATA**

**HEATER OPERATION**

Heater Voltage .....  
 Heater Current .....  
 Maximum Heater-Cathode Voltage .....

50 Volts  
 150 Ma  
 180 Volts

**DIRECT INTERELECTRODE CAPACITANCES (Unshielded)**

Grid to Plate .....  
 Input .....  
 Output .....

0.64 Pf  
 13 Pf  
 6.5 Pf

**RATINGS (Design Center Rating System)**

Plate Voltage (Max.) .....  
 Grid No. 2 Voltage (Max.) .....  
 Plate Dissipation (Max.) .....  
 Grid No. 2 Dissipation (Max.) .....  
 Control Grid Circuit Resistance  
 Fixed Bias (Max.) .....  
 Cathode Bias (Max.) .....

135 Volts  
 117 Volts  
 5.5 Watts  
 1.25 Watts  
 0.1 Megohm  
 0.5 Megohm

**CHARACTERISTICS AND TYPICAL OPERATION**

**Class A1 Amplifier**

Plate Voltage .....  
 Grid No. 2 Voltage .....  
 Grid No. 1 Voltage .....  
 Peak AF Grid No. 1 Voltage .....  
 Zero-Signal Plate Current .....  
 Maximum-Signal Plate Current .....  
 Zero-Signal Grid No. 2 Current .....  
 Maximum-Signal Grid No. 2 Current .....  
 Plate Resistance (Approx.) .....  
 Transconductance .....  
 Load Resistance .....  
 Maximum Signal Power Output .....  
 Total Harmonic Distortion (Approx.) .....

110 Volts  
 110 Volts  
 -7.5 Volts  
 7.5 Volts  
 49 Ma  
 50 Ma  
 4.0 Ma  
 8.5 Ma  
 10,000 Ohms  
 7500 μmhos  
 2500 Ohms  
 1.9 Watts  
 9.0 Percent

**HALF-WAVE RECTIFIER**

**50DC4**

**Heater-Cathode Diode**

Construction ..... Miniature T-5½  
 Base ..... Button 7 Pin, E7-1  
 Basing ..... .5BQ  
 Outline ..... 5-3  
 Maximum Diameter ..... 0.750 In.  
 Maximum Seated Height ..... 2.375 In.  
 Maximum Overall Height ..... 2.625 In.

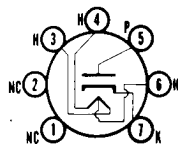

5BQ



**ELECTRICAL DATA**

**HEATER OPERATION (Without Panel Lamp)**

Heater Voltage (AC or DC) .....  
 Heater Tap Voltage .....  
 Heater Current .....  
 Maximum Heater-Cathode Voltage  
 Heater Negative with Respect to Cathode .....  
 Heater Positive with Respect to Cathode .....

50 Volts  
 7.5 Volts  
 150 Ma  
 330 Volts  
 330 Volts

**RATINGS (Design Maximum Rating System)**

**Rectifier Service**

Peak Inverse Plate Voltage (Max.) .....	330 Volts
Steady State Peak Plate Current (Max.) .....	720 Ma
DC Output Current	
Without Panel Lamp (Max.).....	120 Ma
With Panel Lamp and Shunting Resistor (Max.) .....	110 Ma
Without Panel Lamp and No Shunting Resistor (Max.) .....	70 Ma
Heater-Tap Voltage When Panel Lamp Fails, RMS (Max.) .....	16.5 Volts

**CHARACTERISTICS AND TYPICAL OPERATION**

**Half-Wave Rectifier with Panel Lamp Number 40 or Number 47**

Heater Voltage (Pin 3 to Pin 4) .....	45	45	45	45 Volts
Heater-Tap Voltage (Pin 4 to Pin 6) .....	5.5	5.5	5.5	5.5 Volts
Heater Current (Between Pins 3 and 6) .....	150	150	150	150 Ma
AC Plate-Supply Voltage, RMS .....	117	117	117	117 Volts
Filter Input Capacitor .....	40	40	40	40 $\mu$ f
Total Effective Plate-Supply Impedance .....	15	15	15	15 Ohms
Panel-Lamp Shunting Resistor .....	450	200	100	75 Ohms
DC Output Current.....	70	80	90	100 Ma

**Half-Wave Rectifier without Panel Lamp**

Heater Voltage (Pin 3 to Pin 4) .....	50 Volts
Heater-Tap Voltage (Pin 4 to Pin 6) .....	7.5 Volts
Heater Current (Between Pins 3 and 4) .....	150 Ma
AC Plate Supply Voltage, RMS .....	117 Volts
Filter Input Capacitor .....	40 $\mu$ f
Total Effective Plate Supply Impedance .....	15 Ohms
DC Output Current .....	110 Ma
DC Output Voltage at Filter Input (Approx.)	
For DC Output Current of 55 Ma .....	130 Volts
For DC Output Current of 110 Ma .....	110 Volts

**Tube Voltage Drop**

For $I_b = 240$ Ma DC .....	21 Volts
-----------------------------	----------



**Beam Power Pentode**

Construction .....	Miniature T-5 $\frac{1}{2}$
Base .....	Button 7 Pin, E7-1
Basing .....	7FZ
Outline .....	5-3
Maximum Diameter .....	0.750 In.
Maximum Seated Height .....	2.375 In.
Maximum Overall Height .....	2.625 In.

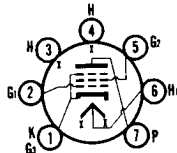

7FZ

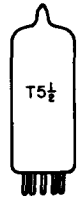

**ELECTRICAL DATA**

**HEATER OPERATION**

Heater Voltage .....	50 Volts
Heater Current .....	150 Ma
Heater Tap Voltage .....	7.0 Volts
Maximum Heater-Cathode Voltage	
Heater Negative with Respect to Cathode	
Total DC and Peak .....	200 Volts
Heater Positive with Respect to Cathode	
DC .....	100 Volts
Total DC and Peak .....	200 Volts

**DIRECT INTERELECTRODE CAPACITANCES (Unshielded)**

Grid No. 1 to Plate .....	0.5 Pf
Input: g1 to (h + k + g2 + g3) .....	17 Pf
Output: p to (h + k + g2 + g3) .....	9.0 Pf

**RATINGS (Design Maximum Rating System)**

Heater-Tap Voltage when Panel Lamp Fails, RMS (Max.) .....	14 Volts
Plate Voltage (Max.) .....	150 Volts
Screen Voltage (Max.) .....	130 Volts
Plate Dissipation (Max.) .....	5.5 Watts
Screen Dissipation (Max.) .....	2.0 Watts



**CHARACTERISTICS AND TYPICAL OPERATION**

**Class A1 Amplifier**

Plate Voltage .....	110 Volts
Screen Voltage .....	115 Volts
Cathode-Bias Resistor .....	62 Ohms
Peak AF Grid No. 1 Voltage .....	3.0 Volts
Plate Resistance (Approx) .....	11,000 Ohms
Transconductance .....	14,600 $\mu$ mhos
Zero-Signal Plate Current .....	42 Ma
Maximum-Signal Plate Current .....	42 Ma
Zero-Signal Screen Current .....	11.5 Ma
Maximum-Signal Screen Current .....	14.5 Ma
Load Resistance .....	3000 Ohms
Total Harmonic Distortion (Approx.) .....	7 Percent
Maximum-Signal Power Output .....	1.4 Watts

**AUDIO POWER AMPLIFIER**

**50HK6**

**Beam Power Pentode**

Construction .....	Miniature T-5 $\frac{1}{2}$
Base .....	Button 7 Pin, E7-1
Basing .....	.7FZ
Outline .....	5-3
Maximum Diameter .....	0.750 In.
Maximum Seated Height .....	2.375 In.
Maximum Overall Height .....	2.625 In.

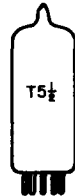
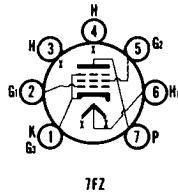

**ELECTRICAL DATA**

**HEATER OPERATION**

Heater Voltage .....	50 Volts
Heater Current .....	150 Ma
Heater Tap Voltage (Without Panel Lamp) .....	7 Volts
Maximum Heater-Cathode Voltage	
Heater Negative with Respect to Cathode	
Total DC and Peak .....	200 Volts
Heater Positive with Respect to Cathode	
DC .....	100 Volts
Total DC and Peak .....	200 Volts

**DIRECT INTERELECTRODE CAPACITANCES (Unshielded)**

Grid No. 1 to Plate .....	0.5 Pf
Input .....	14.0 Pf
Output .....	9.0 Pf

**RATINGS (Design Maximum Rating System)**

Heater Tap Voltage When Panel Lamp Fails, RMS (Max.) .....	14 Volts
Plate Voltage (Max.) .....	150 Volts
Screen Voltage (Max.) .....	130 Volts
Plate Dissipation (Max.) .....	5.5 Watts
Screen Dissipation (Max.) .....	1.1 Watts
Grid No. 1 Circuit Resistance	
Fixed Bias (Max.) .....	0.1 Megohm
Cathode Bias (Max.) .....	0.5 Megohm

**CHARACTERISTICS AND TYPICAL OPERATION**

**Class A1 Amplifier**

Plate Voltage .....	110 Volts
Screen Voltage .....	110 Volts
Grid No. 1 Voltage .....	-7.5 Volts
Peak AF Grid No. 1 Voltage .....	7.5 Volts
Plate Resistance (Approx.) .....	10,000 Ohms
Transconductance .....	7500 $\mu$ mhos
Zero-Signal Plate Current .....	49 Ma
Maximum-Signal Plate Current .....	50 Ma
Zero-Signal Screen Current .....	4.0 Ma
Maximum-Signal Screen Current .....	8.5 Ma
Load Resistance .....	2500 Ohms
Total Harmonic Distortion (Approx.) .....	9 Percent
Maximum-Signal Power Output .....	1.9 Watts

**50JY6****HORIZONTAL DEFLECTION  
AMPLIFIER****Beam Power Pentode**

Construction ..... Octal T-9  
 Base ..... Octal 7 or 8 Pin, B7-59 or B8-58  
 Top Cap ..... C1-2 or C1-3  
 Basing ..... 8MG  
 Outline

Maximum Diameter ..... 1.188 In.  
 Maximum Seated Height ..... 3.740 In.  
 Maximum Overall Height ..... 4.331 In.

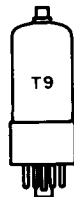
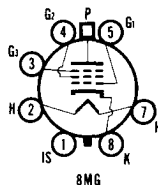
**ELECTRICAL DATA****HEATER OPERATION**

Heater Voltage.....	50 Volts
Heater Current .....	150 Ma
Maximum Heater-Cathode Voltage	
Heater Negative with Respect to Cathode	
DC .....	250 Volts
Total DC and Peak.....	250 Volts
Heater Positive with Respect to Cathode	
DC .....	200 Volts
Total DC and Peak.....	250 Volts

**DIRECT INTERELECTRODE CAPACITANCES (Unshielded)**

Grid No. 1 to Plate (Max.).....	1.1 Pf
Input: g1 to (h + k + g2 + g3) .....	17.5 Pf
Output: p to (h + k + g2 + g3) .....	8 Pf

**RATINGS (Design Maximum Rating System)**

Plate Voltage (Max.) .....	275 Volts
Plate Voltage Without Plate Current (Max.).....	600 Volts
Peak Positive Pulse Plate Voltage (Max.) <sup>(1)</sup> .....	7700 Volts
Peak Negative Pulse Plate Voltage (Max.) <sup>(1)</sup> .....	1650 Volts
Grid No. 3 Voltage (Max.) <sup>(2)</sup> .....	70 Volts
Grid No. 2 Voltage (Max.) .....	275 Volts
Peak Negative Pulse Grid No. 1 Voltage (Max.) .....	1100 Volts
Grid No. 2 Voltage Without Grid No. 2 Current (Max.).....	600 Volts
Plate Dissipation (Max.) .....	13 Watts
Grid No. 2 Dissipation (Max.) .....	5.5 Watts
DC Cathode Current (Max.) .....	220 Ma
Grid No. 1 Circuit Resistance (Max.).....	0.5 Megohm
Grid No. 1 Circuit Resistance	
For Line Output Tube Application Only (Max.).....	2.2 Megohms
Circuit Resistance Between Heater Cathode (Max.) .....	20,000 Ohms

**CHARACTERISTICS AND TYPICAL OPERATION**

Plate Voltage .....	100 Volts
Grid No. 3 Voltage .....	Connected to Cathode at Socket
Grid No. 2 Voltage .....	100 Volts
Grid No. 1 Voltage .....	-8.2 Volts
Plate Current .....	100 Ma
Grid No. 2 Current .....	7 Ma
Transconductance .....	14,000 $\mu$ mhos
Plate Resistance (Approx.) .....	5000 Ohms
Amplification Factor <sup>(3)</sup> .....	5.6

**NOTES:**

- (1) Valid for application in horizontal deflection amplifiers circuits where the maximum pulse duration is 22% of a cycle with a maximum of 18  $\mu$ sec.
- (2) In horizontal deflection amplifier service, a positive voltage may be applied to grid No. 3 to reduce interference from snivets which may occur in both VHF and UHF television receivers. A typical value for this voltage is 30 volts.
- (3) With Grid No. 2 connected to plate at socket.

**AUDIO POWER AMPLIFIER  
MODULATOR or RF POWER AMP.**

**6146B/8298A**

**Beam Power Pentode**

Construction .....Octal T-12  
 Base.....Octal 8 Pin, B8-150 or B8-159  
 Top Cap .....C1-1  
 Basing .....7CK  
 Outline  
 Maximum Diameter .....1.562 In.  
 Maximum Seated Height .....3.125 In.  
 Maximum Overall Height .....3.687 In.

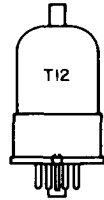
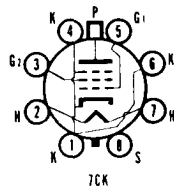

**ELECTRICAL DATA**

**HEATER OPERATION**

Heater Voltage ..... 6.3 Volts  
 Heater Current ..... 1125 Ma  
 Maximum Heater-Cathode Voltage  
 Heater Negative with Respect to Cathode ..... 135 Volts  
 Heater Positive with Respect to Cathode ..... 135 Volts

**MAINTENANCE OF POWER CAPABILITY**

With heater voltage reduced to 5.0 Volts, the power output obtained under the classes of service contained in these defining data will not be reduced by more than ten percent from that obtained at rated heater voltage. Plate input power for the classes of service would be maintained at that obtained using rated heater voltage.

**DIRECT INTERELECTRODE CAPACITANCES (Unshielded)**

Grid No. 1 to Plate (Max.) ..... 0.22 Pf  
 Input ..... 13.0 Pf  
 Output ..... 8.5 Pf

**RATINGS (Absolute Maximum Rating System)**

**AF Amplifier and Modulator**

	Class AB1		Class AB2	
	CCS	ICAS	CCS	ICAS
Plate Voltage	600	750	600	750 Volts
Grid No. 2 Voltage	250	250	250	250 Volts
Plate Current (Max. Signal) <sup>(1)</sup>	175	220	175	220 Ma
Plate Input (Max. Signal) <sup>(1)</sup>	90	120	90	120 Watts
Plate Dissipation <sup>(1)</sup>	27	35	27	35 Watts
Grid No. 2 Input (Max. Signal) <sup>(1)</sup>	3	3	3	3 Watts
Grid No. 1 Circuit Resistance <sup>(4,5)</sup>	0.1	0.1	0.03	0.03 Megohm

**Linear RF Amplifier—Class AB1 (Single Sideband Suppressed Carrier)**

	CCS		ICAS
	CCS	ICAS	
Plate Voltage	600	750 Volts	750 Volts
Grid No. 2 Voltage	250	250 Volts	250 Volts
Plate Current (Max. Signal)	175	220 Ma	220 Ma
Plate Dissipation	27	35 Watts	35 Watts
Grid No. 2 Dissipation	3	3 Watts	3 Watts

**RF Amplifier Service—Class C**

	Telephony <sup>(1)</sup>		Telegraphy or F. M. Telephony	
	CCS	ICAS	CCS	ICAS
Plate Voltage	480	600	600	750 Volts
Grid No. 2 Voltage	250	250	250	250 Volts
Grid No. 1 Voltage	-150	-150	-150	-150 Volts
Plate Current	145	180	175	220 Ma
Grid No. 1 Current	3.5	4.0	3.5	4.0 Ma
Plate Input	60	85	90	120 Watts
Plate Dissipation	18	23	27	35 Watts
Grid No. 2 Input	2	2	3	3 Watts
Grid No. 1 Circuit Resistance <sup>(13)</sup>	0.03	0.03	0.03	0.03 Megohm

**CHARACTERISTICS AND TYPICAL OPERATION**

Plate Voltage ..... 200 Volts  
 Grid No. 2 Voltage ..... 200 Volts  
 Plate Current ..... 100 Ma  
 Transconductance ..... 7000  $\mu$ mhos  
 Amplification Factor (G1 to G2) ..... 4.5

**AF Power Amplifier—Class AB1 (2 Tubes)**

	CCS	CCS
Plate Voltage .....	600	750 Volts
Grid No. 2 Voltage <sup>(2)</sup> .....	200	200 Volts
Grid No. 1 Voltage .....	-47	-48 Volts
Peak AF G1 to G1 Voltage <sup>(3)</sup> .....	94	96 Volts
Plate Current (Zero Signal) .....	48	50 Ma
Plate Current (Max. Signal) .....	250	250 Ma
Grid No. 2 Current (Max. Signal) .....	14.8	12.6 Ma
Load Resistance (P1 to P1) .....	5.6	7.2 K Ohms
Power Output .....	96	124 Watts

**AF Power Amplifier—Class AB2 (2 Tubes)**

	CCS	CCS	ICAS	ICAS
Plate Voltage .....	500	600	600	750 Volts
Grid No. 2 Voltage <sup>(2)</sup> .....	200	200	200	150 Volts
Grid No. 1 Voltage .....	-46	-48	-47	-39 Volts
Peak AF G1 to G1 Voltage .....	108	106	114	110 Volts
Plate Current (Zero Signal) .....	50	40	50	40 Ma
Plate Current (Max. Signal) .....	308	270	328	294 Ma
Grid No. 2 Current (Max. Signal) .....	26	27	26	28 Ma
Grid No. 1 Current (Max. Signal) .....	2.7	1.3	3.4	7.6 Ma
Load Resistance (P1 to P1) .....	3620	5200	4160	6050 Ohms
Driving Power (Max. Signal) <sup>(5)</sup> .....	0.2	0.7	0.2	0.5 Watt
Power Output (Max. Signal) .....	100	110	130	148 Watts

**Linear RF Amplifier (At 30 MHz)**

	CCS	ICAS
Plate Voltage .....	600	750 Volts
Grid No. 2 Voltage <sup>(7)</sup> .....	200	200 Volts
Grid No. 1 Voltage <sup>(7)</sup> .....	-47	-48 Volts
Plate Current (Zero Signal) .....	24	25 Ma
Load Resistance .....	2800	3600 Ohms
Plate Current (Max. Signal) .....	125	125 Ma
Average Plate Current .....	86	86 Ma
Grid No. 2 Current (Max. Signal) .....	7.4	6.3 Ma
Average Grid No. 2 Current .....	5.0	3.9 Ma
Distortion Level <sup>(8)</sup>		
Third Order .....	24	26 db
Fifth Order .....	30	31 db
Useful Power Output		
Average .....	24.5	30.5 Watts
Peak-Envelope .....	49	61 Watts

**RF Power Amplifier—Class C Telephony (Up to 60 MHz)**

	CCS	ICAS
Plate Voltage .....	475	600 Volts
Grid No. 2 Voltage <sup>(9)</sup> .....	165	175 Volts
Grid No. 1 Voltage <sup>(10)</sup> .....	-86	-92 Volts
Grid No. 1 Resistor .....	26K	27K Ohms
Peak RF Grid No. 1 Voltage .....	106	114 Volts
Grid No. 1 Current .....	3.3	3.4 Ma
Plate Current .....	125	140 Ma
Grid No. 2 Current .....	8.5	9.5 Ma
Driving Power (Approx.) .....	0.4	0.5 Watts
Power Output (Approx.) .....	42	62 Watts

**RF Power Amplifier—Class C Telephony—F. M. Telephony**

	Up to 60 MHz		Up to 175 MHz		
	CCS	ICAS	CCS	ICAS	ICAS
Plate Voltage .....	600	750	320	400	435 Volts
Grid No. 2 Voltage <sup>(11)</sup> .....	200	200	210	220	230 Volts
Grid No. 1 Voltage <sup>(12)</sup> .....	-70	-77	-52	-55	-56 Volts
Grid No. 1 Resistor .....	24K	28K	26K	30K	24K Ohms
Peak RF Grid No. 1 Voltage .....	90	95	65	67	73 Volts
Grid No. 1 Current .....	2.8	2.7	2	1.9	2.3 Ma
Plate Current .....	150	160	170	180	210 Ma
Grid No. 2 Current .....	10	10	12	12	11 Ma
Driving Power (Approx.) .....	0.3	0.3	2	2	3 Watts
Power Output .....	63	85	29	40	50 Watts

**NOTES:**

- (1) Averaged over any audio-frequency cycle of sinewave form.
- (2) Obtained preferably from a separate source or from the plate voltage supply with a voltage divider.
- (3) The driver stage should be capable of supplying the No. 1 grids of the Class AB1 stage with the specified driving voltage at low distortion.
- (4) The type of input coupling network used should not introduce too much resistance in the Grid No. 1 circuit. Transformer or impedance coupling devices are recommended.

- (5) Driver stage should be capable of supplying the specified driving power at low distortion to the No. 1 grids of the AB2 stage.
- (6) To minimize distortion, the effective resistance per Grid No. 1 circuit of the AB2 stage should be held at a low value. For this purpose the use of transformer coupling is recommended. In no case, however, should the total dc Grid No. 1 circuit resistance exceed 30,000 ohms when the tube is operated at maximum ratings. For operation less than maximum ratings, the dc Grid No. 1 circuit resistance may be as high as 100,000 ohms.
- (7) Obtained preferably from a separate, well-regulated source.
- (8) Referenced to either of the two tones and without the use of feedback to enhance linearity.
- (9) Obtained preferably from a separate source modulated with the plate supply, or from the modulated plate supply through a series resistor.
- (10) Obtained from Grid No. 1 resistor or from a combination of Grid No. 1 resistor with either fixed supply or cathode resistor.
- (11) Obtained preferably from separate source, or from the plate-supply voltage with a voltage divider or through a series resistor. A series Grid No. 2 resistor should be used only when the tube is used in a circuit which is not keyed. Grid No. 2 voltage must not exceed 435 volts under key-up conditions.
- (12) Obtained from fixed supply, by Grid No. 1 resistor, by cathode resistor, or by combination methods.
- (13) When Grid No. 1 is driven positive and the tube is operated at maximum ratings, the total dc Grid No. 1 circuit resistance should not exceed the specified value of 30,000 ohms. If this value is insufficient to provide adequate bias, the additional required bias must be supplied by a cathode resistor or fixed supply. For operation at less than maximum ratings, the dc Grid No. 1 circuit resistance may be as high as 100,000 ohms.

**AUDIO POWER AMPLIFIER**

**6973**

**Beam Power Pentode**

Construction ..... Miniature T-6½  
 Base ..... Button 9 Pin, E9-1  
 Basing ..... 9EU  
 Outline ..... 6-4  
 Maximum Diameter ..... 0.875 In.  
 Maximum Seated Height ..... 2.812 In.  
 Maximum Overall Height ..... 3.062 In.

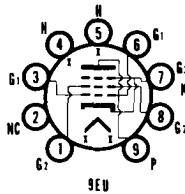

**ELECTRICAL DATA**

**HEATER OPERATION**

Heater Voltage.....	6.3 Volts
Heater Current.....	450 Ma
Maximum Heater-Cathode Voltage	
Heater Negative with Respect to Cathode	
Total DC and Peak.....	200 Volts
Heater Positive with Respect to Cathode	
DC.....	100 Volts
Total DC and Peak.....	200 Volts

**DIRECT INTERELECTRODE CAPACITANCES (Unshielded)**

Grid No. 1 to Plate .....	0.4 Pf
Input .....	9.0 Pf
Output .....	6.0 Pf

**RATINGS (Design Maximum Rating System)**

	Ultra-Linear Conn.	Pentode Conn.
Plate and Grid No. 2 Voltage (Max.) .....	410	— Volts
Plate Voltage (Max.) .....	—	440 Volts
Grid No. 2 Voltage (Max.) .....	—	330 Volts
Plate Dissipation (Max.) .....	12	12 Watts
Grid No. 2 Input (Max.) .....	1.75	2 Watts
Grid No. 1 Circuit Resistance		
Fixed Bias (Max.) .....	0.5	0.5 Megohm
Self Bias (Max.) .....	1.0	1.0 Megohm
Bulb Temperature (Max.) .....	250	250 °C

**CHARACTERISTICS AND TYPICAL OPERATION**

	S. T. Class A	P-P Class AB Fixed Bias			P-P Class AB Self Bias	
		250	350	400	300	310 Volts
Plate Voltage	250	250	350	400	300	310 Volts
Grid No. 2 Voltage	250	250	280	290	300	310 Volts
Grid No. 1 Voltage	-15	-15	-22	-25	—	— Volts
Cathode Resistor	—	—	—	—	230	270 Ohms
Peak AF Grid No. 1 Voltage	—	15	22	25	24	22.5 Volts
Plate Current (Zero Signal)	46	92	58	50	80	77 Ma
Plate Current (Max. Signal)	—	105	106	107	96	92 Ma
Grid No. 2 Current (Zero Signal)	3.5	7	3.5	2.5	6	5 Ma
Grid No. 2 Current (Max. Signal)	—	16	14	13.7	14	14 Ma
Transconductance	4.8K	—	—	—	—	— $\mu$ mhos
Plate Resistance	73K	—	—	—	—	— Ohms
Load Resistance (P to P)	—	8K	7.5K	8K	5.5K	6K Ohms
Power Output	—	12.5	20	24	15	17 Watts
Total Harmonic Distortion	—	2	1.5	2	2	4 Percent
E <sub>c1</sub> for I <sub>b</sub> = 100 $\mu$ a	-40	—	—	—	—	— Volts

**Class AB Ultra-Linear Conn.**

Plate Supply Voltage	375 <sup>(1)</sup>	370 <sup>(2)</sup> Volts
Grid No. 1 Voltage	-33.5	— Volts
Cathode Resistor	—	355 Ohms
Peak AF Grid No. 1 Voltage	33.5	31 Volts
Cathode Current (Zero Signal)	62	74 Ma
Cathode Current (Maximum Signal)	95	84 Ma
Load Resistance (P to P)	12.5K	13K Ohms
Power Output	18.5	15 Watts
Total Harmonic Distortion	1.5	1.2 Percent

**NOTES:**

- (1) Obtained from taps on the primary winding of the output transformer. The taps are located on each side of the center tap so as to apply 50 percent of the plate signal voltage to Grid No. 2 of each output tube.
- (2) Obtained from taps on the primary winding of the output transformer. The taps are located on each side of the center tap so as to supply 43 percent of the plate signal voltage to Grid No. 2 of each output tube.

**7025**

*Color Television Type*

**AF AMPLIFIERS or  
PHASE INVERTERS**

**Double High Mu Triode**

Construction ..... Miniature T-6½  
 Base ..... Button 9 Pin, E9-1  
 Basing ..... 9A  
 Outline ..... 6-2  
     Maximum Diameter ..... 0.875 In.  
     Maximum Seated Height ..... 1.937 In.  
     Maximum Overall Height ..... 2.187 In.  
 The Type 7025 is identical to the Type 12AX7/ECC83 except for improved noise and hum characteristics.

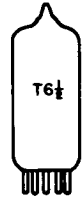
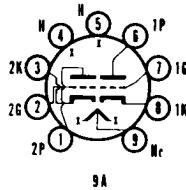

**7189A**

**AUDIO POWER AMPLIFIER**

**Beam Power Pentode**

Construction ..... Miniature T-6½  
 Base ..... Button 9 Pin, E9-1  
 Basing ..... 9LE  
 Outline ..... 6-4  
     Maximum Diameter ..... 0.875 In.  
     Maximum Seated Height ..... 2.812 In.  
     Maximum Overall Height ..... 3.062 In.

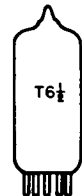
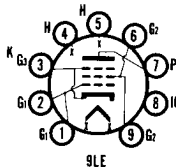

**ELECTRICAL DATA**

**HEATER OPERATION**

Heater Voltage.....	6.3 Volts
Heater Current .....	760 Ma
Maximum Heater-Cathode Voltage	
Heater Negative with Respect to Cathode .....	100 Volts
Heater Positive with Respect to Cathode .....	100 Volts

**DIRECT INTERELECTRODE CAPACITANCES**

Grid No. 1 to Plate (Max.).....	0.5 Pf
Input .....	10.8 Pf
Output .....	6.5 Pf
Grid No. 1 to Heater (Max.) .....	0.25 Pf

**RATINGS (Design Maximum Rating System)**

	Class AB Pentode Conn.	Class AB Ultra-linear Conn.
Plate Voltage (Max.) .....	440	415 Volts
Grid No. 2 Voltage (Max.) <sup>(1)</sup> .....	400	415 Volts
Plate Dissipation (Max.) .....	13.2	13.2 Watts
Grid No. 2 Dissipation (Zero Signal) (Max.) .....	2.2	2.2 Watts
Grid No. 2 Dissipation (Max. Signal) (Max.).....	4.4	4.4 Watts
Cathode Current (Max.).....	72	72 Ma
Grid No. 1 Circuit Resistance		
Fixed Bias (Max.) .....	0.3	0.3 Megohm
Cathode Bias (Max.) .....	1.0	1.0 Megohm

**CHARACTERISTICS AND TYPICAL OPERATION**

	Pentode Conn.		Ultra-linear Conn.
	Single Tube Class A1	Class AB Push-Pull	Class AB Push-Pull
Plate Voltage .....	250	400	375 Volts
Grid No. 2 Voltage .....	250	300	Note 1 Volts
Grid No. 1 Voltage .....	-7.3	-15	— Volts
Cathode Resistor .....	—	—	220 Ohms
Grid Voltage (RMS) <sup>(2)</sup> .....	—	10.5	12.5 Volts
Plate Current (Zero Signal) .....	48	30	70 Ma
Plate Current (Max. Signal) .....	—	105	81 Ma
Grid No. 2 Current (Zero Signal) .....	5.5	1.6	— Ma
Grid No. 2 Current (Max. Signal) .....	—	25	— Ma
Transconductance .....	11.3K	—	— $\mu$ mhos
Amplification Factor <sup>(3)</sup> .....	19.5	—	—
Plate Resistance.....	40K	—	— Ohms
Load Resistance (P to P) .....	—	8K	11K Ohms
Maximum Signal Power Output .....	—	24	16.5 Watts
Total Harmonic Distortion .....	—	4.0	3 Percent

**NOTES:**

- (1) Grid No. 2 voltage is obtained from taps located at 43 percent of the output transformer windings.
- (2) Per grid
- (3) Measured from Grid No. 1 to Grid No. 2.

**PREAMPLIFIER (P)  
PHASE INVERTER (T)**

**7199**

**Medium Mu Triode and  
Sharp Cutoff Pentode**

Construction .....	Miniature T-6½
Base .....	Button 9 Pin, E9-1
Basing .....	.9JT
Outline .....	6-2
Maximum Diameter .....	.0.875 In.
Maximum Seated Height .....	1.937 In.
Maximum Overall Height .....	2.187 In.

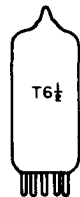
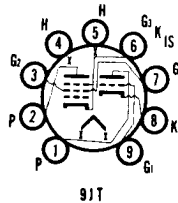

**ELECTRICAL DATA**

**HEATER OPERATION**

Heater Voltage.....	6.3 Volts
Heater Current .....	450 Ma

<b>Maximum Heater-Cathode Voltage</b>	
Heater Negative with Respect to Cathode	
Total DC and Peak.....	200 Volts
Heater Positive with Respect to Cathode	
DC .....	100 Volts
Total DC and Peak.....	200 Volts

**DIRECT INTERELECTRODE CAPACITANCES (Unshielded)**

<b>Triode Section</b>	
Grid to Plate .....	2.0 Pf
Input: g to (h + k) .....	2.3 Pf
Output: p to (h + k) .....	0.3 Pf
<b>Pentode Section</b>	
Grid No. 1 to Plate (Max.).....	0.06 Pf
Input: g1 to (h + k + g2 + g3 + IS).....	5.0 Pf
Output: p to (h + k + g2 + g3 + IS).....	2.0 Pf

**RATINGS (Design Maximum Rating System)**

	<b>Triode Section</b>	<b>Pentode Section</b>
Plate Voltage (Max.) .....	330	330 Volts
Grid No. 2 Supply Voltage (Max.) .....	—	330 Volts
Grid No. 2 Voltage .....	See Rating Chart (Gen. Info. Sec.)	
Positive Grid No. 1 Voltage (Max.) .....	0	0 Volt
Plate Dissipation (Max.) .....	2.4	3.0 Watts
Grid No. 2 Dissipation (Max.) .....	—	0.6 Watt
Grid Circuit Resistance		
Fixed Bias (Max.) .....	0.5	0.25 Megohm
Cathode Bias (Max.) .....	1.0	1.0 Megohm

**CHARACTERISTICS AND TYPICAL OPERATION**

	<b>Triode Section</b>	<b>Pentode Section</b>
Plate Voltage .....	215	100 220 Volts
Grid No. 2 Voltage .....	—	50 130 Volts
Grid No. 1 Voltage .....	8.5	— Volts
Cathode Bias Resistor .....	—	1000 62 Ohms
Plate Current .....	9.0	1.1 12.5 Ma
Grid No. 2 Current .....	—	0.35 3.5 Ma
Transconductance .....	2100	1500 7000 $\mu$ mhos
Amplification Factor .....	17	—
Plate Resistance.....	0.0081	1.0 0.4 Megohm
Ec1 for Ib = 10 $\mu$ a (Approx.) .....	40	4 — Volts

**Equivalent Noise and Hum Voltage (Referenced to Grid)**

	<b>Triode Section<sup>(1)</sup></b>	<b>Pentode Section<sup>(2)</sup></b>
Average Value .....	10	15 $\mu$ Volts rms
Maximum Value .....	50	35 $\mu$ Volts rms

**NOTES:**

- (1) Measured under the following conditions: Ef = 6.3 Vac; center-tap of heater transformer grounded; Ebb = 250 Vdc; RL = 0.1 Megohm; Rk = 1500 ohms; Rg = 50,000 ohms; F = 25 to 10,000 Hertz.
- (2) Measured under the following conditions: Ef = 6.3 Vac; center tap of heater transformer grounded; Ebb = 250 Vdc; RL = 0.22 Megohm; Ecc2 = 250 Vdc; Rg2 = 330,000 ohms; Cg2 = 0.1  $\mu$ f; RK = 680 ohms; Rg1 = 0.27 Megohms; F = 25 to 10,000 Hertz.

7543

AF AMPLIFIER

**Sharp Cutoff Pentode**

Construction .....Miniature T-5½  
 Base .....Button 7 Pin, E7-1  
 Basing .....7BK  
 Outline .....5-2  
 Maximum Diameter .....0.750 In.  
 Maximum Seated Height .....1.875 In.  
 Maximum Overall Height .....2.125 In.

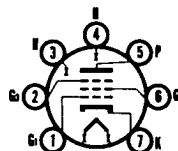

7BK

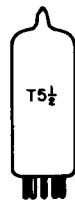



**ELECTRICAL DATA**  
**HEATER OPERATION**

Heater Voltage.....	6.3 Volts
Heater Current .....	300 Ma
Maximum Heater-Cathode Voltage	
Heater Negative with Respect to Cathode	
Total DC and Peak.....	200 Volts
Heater Positive with Respect to Cathode	
DC .....	100 Volts
Total DC and Peak.....	200 Volts

**DIRECT INTERELECTRODE CAPACITANCES**

	Shielded <sup>(1)</sup>	Unshielded
<b>Pentode Connection</b>		
Grid No. 1 to Plate (Max.).....	0.0035	0.0035 Pf
Input: g1 to (h + k + g2 + g3 + IS).....	5.5	5.5 Pf
Output: p to (h + k + g2 + g3 + IS).....	5.0	5.0 Pf
<b>Triode Connection<sup>(2)</sup></b>		
Grid to Plate: g1 to (p + g2 + g3 + IS) .....	2.6	2.6 Pf
Input: g1 to (h + k) .....	3.2	3.2 Pf
Output: p + g2 + g3 + IS to (h + k) .....	8.5	1.2 Pf

**RATINGS (Design Center Rating System)**

	Triode Conn. <sup>(2)</sup>	Pentode Conn.
Plate Voltage (Max.) .....	250	300 Volts
Grid No. 2 Supply Voltage (Max.) .....	—	300 Volts
Grid No. 2 Voltage .....	See Rating Chart (Gen. Info. Sec.)	
Plate Dissipation (Max.) .....	3.2	3.0 Watts
Grid No. 2 Dissipation (Max.) .....	—	0.65 Watt
Positive Grid No. 1 Voltage (Max.) .....	0	0 Volt

**CHARACTERISTICS AND TYPICAL OPERATION**

	Triode Conn. <sup>(2)</sup>	Pentode Connected	
		100	250 Volts
Plate Voltage .....	250	100	250 Volts
Grid No. 3 Voltage .....	—	Connected to Cathode at Socket	
Grid No. 2 Voltage .....	—	100	125 150 Volts
Cathode Bias Resistor .....	330	150	100 68 Ohms
Plate Current .....	12.2	5.0	7.6 10.6 Ma
Grid No. 2 Current .....	—	2.1	3.0 4.3 Ma
Transconductance .....	4800	3900	4500 5200 $\mu$ mhos
Amplification Factor .....	36	—	—
Plate Resistance (Approx.) .....	—	0.5	1.5 1.0 Megohms
Ec1 for Ib = 10 $\mu$ a (Approx.) .....	—	-4.2	-5.5 -6.5 Volts

**NOTES:**

- (1) Shield No. 316 connected to Cathode Pin No. 7.
- (2) When operated as a triode Grid No. 2 and Grid No. 3 should be tied to the plate.

**AUDIO POWER AMPLIFIER**

**7591A**

**Beam Power Pentode**

Construction .....	Octal T-9
Base.....	Octal 7 Pin, B7-233 or B8-142
Basing .....	.8KG
Outline .....	.9-11
Maximum Diameter .....	1.188 In.
Maximum Seated Height .....	2.750 In.
Maximum Overall Height .....	3.312 In.

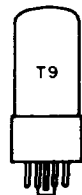
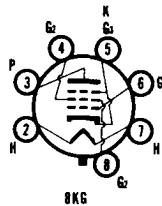

**ELECTRICAL DATA**

**HEATER OPERATION**

Heater Voltage.....	6.3 Volts
Heater Current .....	800 Ma
Maximum Heater-Cathode Voltage	
Heater Negative with Respect to Cathode	
Total DC and Peak.....	200 Volts

Heater Positive with Respect to Cathode	
DC .....	100 Volts
Total DC and Peak.....	200 Volts

**DIRECT INTERELECTRODE CAPACITANCES (Unshielded)**

Grid No. 1 to Plate .....	0.25 Pf
Input .....	10 Pf
Output .....	5.0 Pf

**RATINGS (Design Maximum Rating System)**

Plate Voltage (Max.) .....	550 Volts
Grid No. 2 Voltage (Max.) .....	440 Volts
Plate Dissipation (Max.) .....	19 Watts
Grid No. 2 Dissipation (Max.) <sup>(1)</sup> .....	3.3 Watts
Cathode Current (Max.).....	85 Ma
Grid No. 1 Circuit Resistance	
Fixed Bias (Max.) .....	0.3 Megohm
Self Bias (Max.) .....	1.0 Megohm

**CHARACTERISTICS AND TYPICAL OPERATION**

	Pentode Operation		Ultra-Linear Operation <sup>(2)</sup>	
	S. T.-		Class AB1 - Push-Pull	
	Class A1 Amp.		Class AB1 - Push-Pull	
Plate Voltage .....	300		400	425 Volts
Grid No. 2 Voltage .....	300		Note 2	Note 2 Volts
Grid No. 1 Voltage .....	-10		-20.5	— Volts
Cathode Resistor .....	—		—	185 Ohms
Peak AF Grid Voltage .....	10		20.5	21 Volts
Zero Signal Plate Current .....	60		80	88 Ma
Max. Signal Plate Current .....	75		138	104 Ma
Zero Signal Grid No. 2 Current .....	8		11.5	13 Ma
Max. Signal Grid No. 2 Current .....	15		26.4	17.5 Ma
Transconductance .....	10.2K		—	— $\mu$ mhos
Plate Resistance (Approx.) .....	29K		—	— Ohms
Load Resistance .....	3K		—	— Ohms
Load Resistance (PL to PL) .....	—		6600	6600 Ohms
Power Output .....	11		32	26 Watts
Total Harmonic Distortion .....	13		1.0	2 Percent

**Pentode Operation (Class AB1 Push-Pull Amp.)**

Plate Voltage .....	300	350	400	450	450	450 Volts
Grid No. 2 Voltage .....	300	350	350	350	400	400 Volts
Grid No. 1 Voltage .....	-12.5	-15.5	-16	-16.5	-21	— Volts
Cathode Resistor .....	—	—	—	—	—	200 Ohms
Peak AF Grid to Grid Voltage .....	25	31	32	33	42	28 Volts
Zero Signal Plate Current .....	86	92	85	77	66	82 Ma
Max. Signal Plate Current .....	116	130	143	153	144	94 Ma
Zero Signal Grid No. 2 Current .....	12.6	13	11	9.6	9.4	11.5 Ma
Max. Signal Grid No. 2 Current .....	26	28.6	27	27	30	22 Ma
Load Resistance (PL to PL) .....	6600	6600	6600	6600	6600	9000 Ohms
Power Output .....	23	30	37	43	45	28 Watts
Total Harmonic Distortion .....	2.4	2	1.5	1.5	1.5	2 Percent

**NOTES:**

- (1) Grid No. 2 Dissipation may be permitted to reach 6 watts during the periods of maximum input of speech and music signals. For efficient operation of Grid No. 2, the two Grid No. 2 connections, Pins 4 and 8, should be externally tied together.
- (2) Grid No. 2 tapped at 40% of the primary winding.

RECEIVING TUBES  
CONDENSED DATA

TYPE	CONSTRUCTION		EMITTER		USE	Plate Diss. Watts?	Negative Grid Volts	Screen Volts	Plate Current Ma.	Screen Current Ma.	Plate Resis. Ohms	Transcon-ductance Micros.	Ampli-fication Factor	Ohms Load for Stated Power Output	Power Output Milli-watts
	Bulb Size or Style	Class	Basing Diag.†	Volts											
OB2 GB-OA2WA (3)	T-5½	Diode	5B0	.....	.....	.....	.....	.....	.....	.....	.....	.....	.....	.....	.....
OA3	ST-12	Diode	4AJ	.....	.....	.....	.....	.....	.....	.....	.....	.....	.....	.....	.....
OA3A	T-9	.....	.....	.....	.....	.....	.....	.....	.....	.....	.....	.....	.....	.....	.....
OA4G	ST-12	Gas Triode	4V	.....	.....	.....	.....	.....	.....	.....	.....	.....	.....	.....	.....
OA5	T-5½	Gas Pentode	OA5	.....	.....	.....	.....	.....	.....	.....	.....	.....	.....	.....	.....
OB2 GB-OB2WA (3)	T-5½	Diode	5B0	.....	.....	.....	.....	.....	.....	.....	.....	.....	.....	.....	.....
OB3 OB3A	ST-12	Diode	4AJ	.....	.....	.....	.....	.....	.....	.....	.....	.....	.....	.....	.....
OB2	T-9	.....	.....	.....	.....	.....	.....	.....	.....	.....	.....	.....	.....	.....	.....
OC3	ST-12	Diode	4AJ	.....	.....	.....	.....	.....	.....	.....	.....	.....	.....	.....	.....
OC3A	T-9	.....	.....	.....	.....	.....	.....	.....	.....	.....	.....	.....	.....	.....	.....
OD3 OD3A	ST-12	Diode	4AJ	.....	.....	.....	.....	.....	.....	.....	.....	.....	.....	.....	.....
OD3A	T-9	.....	.....	.....	.....	.....	.....	.....	.....	.....	.....	.....	.....	.....	.....
OY4 OY4G	Metal T-7	Gas Diode	4BU	.....	.....	.....	.....	.....	.....	.....	.....	.....	.....	.....	.....
1AG	T-5½	Diode	5AP	1.4	0.150	Detector	.....	.....	.....	.....	.....	.....	.....	.....	.....
1AG5GT	T-9	Power Pent.	6X	1.4†	0.050	Power Amp.	.....	.....	.....	.....	.....	.....	.....	.....	.....
1A7GT	T-9	Heptode	7Z	1.4†	0.050	Converter	.....	.....	.....	.....	.....	.....	.....	.....	.....
1AC5	T-3	Pentode	8CP	1.25†	0.040	Power Amp.	.....	.....	.....	.....	.....	.....	.....	.....	.....
1AD5	T-3	Pentode	8CP	1.25†	0.040	R-F Amp.	.....	.....	.....	.....	.....	.....	.....	.....	.....
1AE4	T-5½	Pentode	6AR	1.25†	0.100	R-F Amp.	.....	.....	.....	.....	.....	.....	.....	.....	.....
1AF4	T-5½	Pentode	6AR	1.4†	0.025	R-F Amp.	.....	.....	.....	.....	.....	.....	.....	.....	.....
1AF5	T-5½	Diode Pent.	6AU	1.4†	0.025	Det. Amp.	.....	.....	.....	.....	.....	.....	.....	.....	.....
1AG4	T-2X3	Pentode	1AG4	1.25†	0.040	Power Amp.	.....	.....	.....	.....	.....	.....	.....	.....	.....
1AG5	T-2X3	Diode Pent.	1AG5	1.25†	0.030	Det. Amp.	.....	.....	.....	.....	.....	.....	.....	.....	.....
1AH4	T-2X3	Pentode	1AH4	1.25†	0.040	R-F Amp.	.....	.....	.....	.....	.....	.....	.....	.....	.....
1AJ2	Comp. T-9	Diode	12EL	1.25†	0.200	Flyback H-W Rect.	.....	.....	.....	.....	.....	.....	.....	.....	.....
1AJ5	T-2X3	Diode Pent.	1AJ5	1.25†	0.040	Det. Amp.	.....	.....	.....	.....	.....	.....	.....	.....	.....

117 A.C. Volts Per Plate, RMS, 75 Ma. Max., 40 Ma. Min. Output Current. Starter Anode Connects to Anode thru 10 Megohms By-Passed with .002 pf. Half Wave Cathode Type Rectifier for H. F. Use.

Operating Current 5 to 30 Ma. Operating Current 5 to 40 Ma. Starter Anode Drop = 60 V. Approx. Trigger Pulse Voltage = 160 Volts. Keep Alive Current = 50 µa. Operating Current 5 to 30 Ma. Operating Current 5 Ma. Min., 30 Ma. Max. Operating Current 5 Ma. Min., 30 Ma. Max. Operating Current 5 Ma. Min., 40 Ma. Max. Operating Current 5 Ma. Min., 40 Ma. Max. Maximum Peak Inverse Plate Voltage = 26,000 Volts. Maximum Peak Plate Current = 50 Ma. Maximum Average Plate Current = 0.5 Ma. 300000 425

1AK4	T-2X3	Pentode	1AK4	1.25 $\phi$	0.020	Class A1 Amp.	....	45	0	45	0.75	0.2	1500000	750	(Screen Supply = 67.5 Volts Thru .11 Meg. Res.)
1AK5	T-2X3	Diode Pent.	1AK5	1.25 $\phi$	0.020	Det. Amp.	....	67.5	0	....	0.75	0.2	2000000	750	
1AN5	T-5 $\frac{1}{2}$	Pentode	7ES	1.4 $\phi$	0.025	I-F Amp.	....	45	0	45	0.5	0.2	400000	280	
1AU2	T-6 $\frac{1}{2}$	Diode	9U	1.10 $\phi$	0.190	Focus H-W Rect.	....	90	0	62	1.7	0.7	450000	940	G1 to G2 = 20
1AU3	T-12	Diode	3C	1.25 $\phi$	0.200	Flyback H-W Rect.	....	....	....	....	....	....	....	....	Maximum Peak Inverse Plate Voltage = 8250 Volts. Maximum Peak Plate Current = 11 Ma. Maximum Average Plate Current = 0.6 Ma.
1AX2	T-6 $\frac{1}{2}$	Diode	9Y	1.4 $\phi$	0.650	Flyback H-W Rect.	....	....	....	....	....	....	....	....	Maximum Peak Inverse Plate Voltage = 30,000 Volts. Maximum Peak Plate Current = 50 Ma. Maximum Average Plate Current = 0.5 Ma.
1BK2/1RK41	T-6 $\frac{1}{2}$	Diode	9Y	1.4 $\phi$	0.350	Flyback H-W Rect.	....	....	....	....	....	....	....	....	Maximum Peak Inverse Plate Voltage = 24,000 Volts. Maximum Peak Plate Current = 44 Ma. Maximum Average Plate Current = 0.88 Ma.
1BL2	T-6 $\frac{1}{2}$	Diode	Pins-Fil. Cap-Fil.	1.25 $\phi$	0.200	Flyback H-V Rect.	....	....	....	....	....	....	....	....	Maximum Peak Inverse Plate Voltage = 22,000 Volts. Maximum Peak Plate Current = 45 Ma. Maximum Average Plate Current = 0.5 Ma.
1BV2	T-6 $\frac{1}{2}$	Diode	1BV2	1.25	0.200	H-W Rect.	....	....	....	....	....	....	....	....	Max. Peak Inverse Plate Voltage = 18,000 Volts. Max. Peak Plate Current = 45 Ma. Max. Avg. Plate Current = 0.5 Ma.
1DK29	T-3	Diode	....	0.9	0.200	HV Rect.	....	....	....	....	....	....	....	....	Max. Peak Inverse Plate Voltage = 9000 Volts. Max. Peak Plate Current = 4.0 Ma. Max. Avg. Plate Current = 0.2 Ma.
1DN5	T-5 $\frac{1}{2}$	Diode Pent.	6BW	1.4 $\phi$	0.050	Det. Amp.	....	67.5	0	67.5	2.1	0.55	.6 Meg.	630	....
1DY4A	T-5 $\frac{1}{2}$	Triode	7DK	1.6	0.600	UHF Osc.	1.5	....	....	....	....	....	....	....	Characteristics Same as Type 6DY4A
1H2	T-6 $\frac{1}{2}$	Diode	9LX	1.4	0.350	Flyback H-W Rect.	....	....	....	....	....	....	....	....	Maximum Peak Inverse Plate Voltage = 24,000 Volts. Maximum Peak Plate Current = 50 Ma. Maximum Average Plate Current = 0.5 Ma.
1H5GT	T-9	Diode	5Z	1.4 $\phi$	0.050	Det. Amp.	....	90	0.0	....	0.15	....	240000	275	65
1J3A	T-9	Diode	3C	1.25 $\phi$	0.200	Flyback H-W Rect.	....	....	....	....	....	....	....	....	Maximum Peak Inverse Plate Voltage = 28,000 Volts. Maximum Peak Plate Current = 50 Ma. Maximum Average Plate Current = 0.5 Ma.
1L4	T-5 $\frac{1}{2}$	Pentode	6AR	1.4 $\phi$	0.050	R-F Amp.	....	90	0	67.5	2.9	1.2	600000	925	....
1L6	T-5 $\frac{1}{2}$	Heptode	7DC	1.4 $\phi$	0.050	Converter	....	90	0	90	4.5	2.0	350000	1025	....
1LA4	Lock-in	Power Pent.	5AD	1.4 $\phi$	0.050	Power Amp.	....	85	4.5	85	3.5	0.7	300000	800	....
1LA6	Lock-in	Heptode	7AK	1.4 $\phi$	0.050	Converter	....	90	0.0	45	4.0	0.8	300000	850	....
1LB4	Lock-in	Power Pent.	5AD	1.4 $\phi$	0.050	Power Amp.	....	45	4.5	45	1.6	0.3	400000	650	....
1L05	Lock-in	Pentode	7AO	1.4 $\phi$	0.050	R-F Amp.	....	45	0.0	45	1.1	0.35	700000	750	....
1L06	Lock-in	Heptode	7AK	1.4 $\phi$	0.050	Converter	....	45	0.0	35	0.7	0.75	300000	250*	(Ga = 45 V. Max, 1.4 Ma.)
1LD5	Lock-in	Diode Pent.	6AX	1.4 $\phi$	0.050	Amplifier	....	45	0.0	45	0.35	0.12	750000	275*	(Ga = 45 V. Max., 1.4 Ma.)
1LE3	Lock-in	Triode	4AA	1.4 $\phi$	0.050	Amplifier	....	90	0.0	45	0.6	0.1	750000	550	....
1LG5	Lock-in	Pentode	7AO	1.4 $\phi$	0.050	R-F Amp.	....	90	3.0	....	4.5	....	11200	1300	14.5
1LH4	Lock-in	Diode Triode	5AG	1.4 $\phi$	0.050	Det. Amp.	....	90	0.0	90	3.7	0.9	500000	1050	....

TYPE	CONSTRUCTION		EMITTER		USE	Plate Diss. Watts*	Plate Volts	Negative Grid Volts	Screen Volts	Plate Current Ma.	Screen Current Ma.	Plate Res. Ohms	Transconductance Micros.	Amplification Factor	Ohms Load for Stated Power Output	Power for Output Milli-watts
	Bulb Size or Style	Class	Basing Diag.	Volts												
1LN5	Lock-in	Pentode	7A0	1.4	0.050	R-F Amp.	90	0.0	90	1.6	0.35	1.1 Meg.	800	.....	.....	.....
1N2A	T-12	Diode	3C	1.25	0.200	Flyback H-W Rect.	.....	.....	.....	.....	.....	.....	.....	.....	.....	.....
1N5GT	T-9	Pentode	5Y	1.4	0.050	R-F Amp.	90	0.0	90	1.2	0.3	1.5 Meg.	750	.....	.....	.....
1R4	Lock-in	H. F. Diode	4AH	1.4	0.150	Detector	.....	.....	.....	.....	.....	.....	.....	.....	.....	.....
1R8	T-5½	Heptode	7AT	1.4	0.050	Converter	.....	.....	.....	.....	.....	.....	.....	.....	.....	.....
1S2A/DY87	T-6½	Diode	9DT	1.4	0.550	HV Rectifier	.....	.....	.....	.....	.....	.....	.....	.....	.....	.....
1S4	T-5½	Power Pent.	7AV	1.4	0.100	Power Amp.	.....	.....	.....	.....	.....	.....	.....	.....	.....	.....
1S5	T-5½	Diode Pent.	6AU	1.4	0.050	Det. Amp.	.....	.....	.....	.....	.....	.....	.....	.....	.....	.....
1S6	T-3	Diode Pent.	8DA	1.25	0.040	Det. Amp.	.....	.....	.....	.....	.....	.....	.....	.....	.....	.....
1T4	T-6½	Pentode	6AR	1.4	0.050	R-F Amp.	.....	.....	.....	.....	.....	.....	.....	.....	.....	.....
1U4	T-5½	Pentode	6AR	1.4	0.050	R-F Amp.	.....	.....	.....	.....	.....	.....	.....	.....	.....	.....
1U5	T-5½	Diode Pent.	6BW	1.4	0.050	Det. Amp.	.....	.....	.....	.....	.....	.....	.....	.....	.....	.....
1U6	T-5½	Heptode	7DC	1.4	0.025	Converter	.....	.....	.....	.....	.....	.....	.....	.....	.....	.....
1V6	T-2x3	Tri. Pentode	1V6	1.25	0.040	R-F Osc. R-F Amp.	.....	.....	.....	.....	.....	.....	.....	.....	.....	.....
2A3	ST-16	Triode	4D	2.5	2.500	S.T. A1 Amp. P.P.AB1 Amp.	250	45.0	.....	60.0	800	800	5250	4.2	2500	3500
2A2Z	T-6½	Diode	9Y	2.1	0.275	Flyback H-W Rect.	300	62.0	.....	80-147†	Push Pull, Fixed Bias	.....	.....	.....	3000†	15000
2B3	T-9	Diode	8HC	1.75	0.250	H-W Rect.	.....	.....	.....	.....	.....	.....	.....	.....	.....	.....
2BA2	T-6½	Diode	9U	1.8	0.300	Flyback H-W Rect.	.....	.....	.....	.....	.....	.....	.....	.....	.....	.....
2BJ2	T-6½	Diode	9RT	2.3	0.300	Flyback H-W Rect.	.....	.....	.....	.....	.....	.....	.....	.....	.....	.....
2C21	ST-12	Duotriode	7BH	6.3	0.600	Amplifier Power Amp.	2.3	250	16.5	.....	.....	.....	.....	8.3	7600	1375
2C22	T-9	Triode	4AM	6.3	0.300	Amplifier	3.3	300	10.5	.....	.....	.....	.....	20.0	.....	3500
2C50	T-9	Duotriode	8BD	12.6	0.300	Amplifier	3.85	200	11	.....	.....	.....	.....	18	3450	2900
2C51	T-6½	Duotriode	8CJ	6.3	0.300	Amplifier	1.65	150	240	.....	.....	.....	.....	8.2	6500	5500
2C52	T-9	Duotriode	8BD	12.6	0.300	Amplifier	1.65	250	2.0	.....	.....	.....	.....	1.3	.....	1900
2C21	T-5½	Gas Tetrode	7BN	6.3	0.600	Relay Tube	.....	400	5	.....	.....	.....	.....	.....	.....	.....

Characteristics Same as Type 1S5.

(Ga = 67.5 V, 1.0 Ma.)  
(Ga = 90 V, 1.1 Ma.)

IG1 = 12 µa  
Conv. = 200\*

Peak Inverse Volts = 22 KV. Output = 0.5 Ma.  
Maximum Peak Plate Voltage = 8250 Volts. Maximum Peak Plate Current = 50 Ma.  
Maximum Average Plate Current = 0.6 Ma.

Peak Inverse Volts = 20,000 Volts. Maximum Peak Plate Current = 45 Ma.  
Maximum Average Plate Current = 1.0 Ma.

Television Service. Flyback Supplies. Peak Inverse Volts = 22 KV. Output = 0.5 Ma.  
Maximum Peak Inverse Plate Voltage = 8250 Volts. Maximum Peak Plate Current = 50 Ma.  
Maximum Average Plate Current = 0.6 Ma.

Maximum Peak Inverse Plate Voltage = 20,000 Volts. Maximum Peak Plate Current = 80 Ma.  
Maximum Average Plate Current = 1.0 Ma.

Average Cathode Current = 100 Max. Ma., Averaged over any 30 Sec. Interval.

2DF4	T-6½	Pentode	9JL	1.25 <sup>†</sup> 2.50 <sup>†</sup>	0.345 0.690	Class "C" Power Amp.	4.5	120	3.6	120	37	3.5	6850	.....	
2DX4	T-5½	Triode	7DK	2.4	0.600	UHF Osc.	2.2	Characteristics Same as Type 6DX4.						.....	
2DY4	T-5½	Triode	7DK	2.05	0.450	UHF Osc.	1.5	Characteristics Same as Type 6DY4.						.....	
2DE6	T-9	Beam Pent.	7CK	6.3	0.800	Class C Amp.	10	500	40.0	185	60.0	11.0	Driving Power = 0.12 Watts. D.C. Grid No. 1 Current = 3.0 Ma.		
2EA5	T-5½	Tetrode	7EW	2.4	0.600	VHF Amp.	3.25	Characteristics Same as Type 6EA5.						.....	
2EG4	Nuvistor	Triode	12AQ	1.7	0.600	VHF Amp.	1.5	110	130 <sup>†</sup>	.....	6.5	7000	12500	68	
2EN5	T-5½	Duodiode	7FL	2.1	0.450	Phase- Comparator	.....	Diode Current for Continuous Operation (Each Plate) = 20 Mils. Diode Characteristics with 5.0 Volts Applied. Id = 20 Ma. (Each Plate—Test Condition Only.)						.....	
2GW5	T-5½	Triode	7GK	2.45	0.600	VHF Amp.	2.5	Characteristics Same as Type 6GW5.						.....	
2HR8	T-6½	Pentode	9BJ	2.5	0.600	Amplifier	1.0	250	2	140	3	0.6	2500	2000	38
2X2A(3)	ST-12	Diode	4AB	2.5 <sup>†</sup>	1.750	.....	.....	Maximum Inverse Plate Voltage = 12,500 Volts, Maximum Peak Current = 60 Ma. Maximum Average Current = 7.5 Ma., Maximum RMS Supply Voltage = 5500 Volts.						.....	
3A4	T-5½	Pentode	7BB	1.4 <sup>†</sup> 2.8 <sup>†</sup>	0.200 0.100	Power Amp.	2.5	135	7.5	90	14.8	2.6	90000	1900	8000
3A5	T-5½	Duodiode	7BC	1.4 <sup>†</sup> 2.8 <sup>†</sup>	0.220 0.110	Amplifier	0.55	90	2.5	.....	3.7	8300	1800	15	.....
3AF4A	T-5½	Triode	7DK	3.2	0.450	UHF Osc.	2.5	Characteristics Same as Type 6AF4A.						.....	
3AW3	T-9	Diode	8EZ	3.15 <sup>†</sup>	0.220	Flyback H-W Rect.	.....	Maximum Peak Inverse Volts = 30,000 Volts. Maximum Peak Plate Current = 88 Ma. Maximum Average Plate Current = 1.7 Ma.						.....	
3B2	T-12	Diode	8GH	3.15	0.220	H-W Rect.	.....	TV Service, Pulsed Rectifier Service, Max. Peak Inverse Volts = 35 Kv, Output = 1.1 Ma.						.....	
3B7	Lock-in	Duodiode	7BE	2.8 <sup>†</sup> 1.4 <sup>†</sup>	0.110 0.220	Power Amp. Oscillator	2.97	135	0	.....	22.0 (Class AB2)	1900	20	15000	1500
3BC5/3CE5	T-5½	Pentode	7BD	3.15	0.600	VHF Amp.	2.3	Characteristics Same as Type 6BC5/6CE5.						.....	
3BF2	T-9	Diode	12GQ	3.6	0.225	Flyback H-W Rect.	.....	Maximum Peak Inverse Plate Voltage = 35,000 Volts. Maximum Peak Plate Current = 115 Ma. Maximum Average Plate Current = 2.2 Ma.						.....	
3BX6	T-6½	Pentode	9AQ	3.4	0.600	VHF Amp.	2.5	100	1.1	57	5.5	1.6	250000	5000	.....
3BY7	T-6½	Pentode	9AQ	3.4	0.600	VHF Amp.	2.7	250	2.0	100	10	2.5	600000	6000	.....
3CF6/3CB6	T-5½	Pentode	7CM	3.15	0.600	VHF Amp.	2.3	Characteristics Same as Type 6CF6.						.....	
3CV3	T-9	Diode	8EZ	3.15 <sup>†</sup>	0.250	Flyback H-W Rect.	.....	Maximum Peak Inverse Plate Voltage = 35,000 Volts. Maximum Peak Plate Current = 100 Ma. Maximum Average Plate Current = 1.9 Ma.						.....	
3CX3	T-9	Diode	8MT	3.15 <sup>†</sup>	0.480	Flyback H-V Rect.	.....	Maximum Peak Inverse Plate Voltage = 38,000 Volts. Maximum Peak Plate Current = 110 Ma. Maximum Average Plate Current = 2.2 Ma.						.....	
3CZ3	T-9	Diode	8EZ	3.15 <sup>†</sup>	0.480	Flyback H-W Rect.	.....	Maximum Peak Inverse Plate Voltage = 38,000 Volts. Maximum Peak Plate Current = 110 Ma. Maximum Average Plate Current = 2.2 Ma.						.....	
3D6	Lock-in	Beam Pent.	6BA	2.8 <sup>†</sup> 1.4 <sup>†</sup>	0.110 0.220	Power Amp.	4.95	150	4.5	90	10.2	1.8	(Class A)	2400	14000
3DA3	T-9	Diode	8MY	3.15	0.480	HV Rect.	.....	Max. Peak Inverse Plate Voltage = 38,000 Volts. Max. Peak Plate Current = 110 Ma. Max. Avg. Plate Current = 2.2 Ma.						.....	
3DB3	T-9	Diode	8MX	3.15	0.245	HV Rect.	.....	Max. Peak Inverse Plate Voltage = 38,000 Volts. Max. Peak Plate Current = 100 Ma. Max. Avg. Plate Current = 2.0 Ma.						.....	
3DHH13	T-3	Twin Triode	8LK	3.5	0.600	Cascode Amp.	1.7	Characteristics Same as Type 6DHH13.						.....	

TYPE	CONSTRUCTION		EMITTER		USE	Plate Diss. Watts:	Plate Volts	Negative Grid Volts	Screen Volts	Plate Current Ma.	Screen Current Ma.	Plate Reas. Ohms	Transconductance Micros.	Amplification Factor	Ohms Load for Stated Output	Power Output Milli-watts
	Bulb Size or Style	Class	Basing Diag.	Volts												
3DT6	T-5½	Gated Beam	7EN	3.15	0.600	1.65	Characteristics Same as Type 6DT6.									
3DX4	T-5½	Triode	7DK	3.0	0.450	2.2	Characteristics Same as Type 6DX4.									
3DY4A	T-5½	Triode	7DK	2.9	0.300	1.5	Characteristics Same as Type 6DY4A.									
3EA5	T-5½	Tetrode	7EW	2.9	0.450	3.25	Characteristics Same as Type 6EA5.									
3FW7	T-3	Twin Triode	8LM	3.5	0.600	.....	Characteristics Same as Type 6FW7.									
3FX7/3DHH13	T-3	Twin Triode	8LK	3.5	0.600	1.7	Characteristics Same as Type 6FX7.									
3GW5	T-5½	Triode	7GK	3.0	0.450	2.5	Characteristics Same as Type 6GW5.									
3KF8	T-6½	Twin Pentode	9FG	3.15	0.600	1.1	Characteristics Same as Type 6KF8.									
3KF6	T-6½	Pentode	9PM	3.5	0.600	3.1	Characteristics Same as Type 6KT6.									
3LF4	Lock-in	Beam Pent.	6BA	1.44 2.84	0.100 0.050	.....	Characteristics Same as Type 3Q5GT.									
3MP26	T-5½	Beam Pent.	6CC	3.5	0.600	4.2	110	10	110	32	1.5	16000	4250	.....	2800	1400
3Q4	T-5½	Power Pent.	7BA	1.44 2.84	0.100 0.050	.....	85	5.0	85	6.9	1.5	120000	1975	.....	10000	250
3Q5GT	T-9	Beam Pent.	7AP	2.84	0.050	.....	90	4.5	90	9.5	2.1	100000	2150	.....	10000	240
3S4	T-5½	Power Pent.	7BA	1.44 2.84	0.100 0.050	.....	90	4.5	90	9.5	1.3	90000	2200	.....	8000	270
3V4	T-5½	Power Pent.	6BX	1.44 2.84	0.100 0.050	.....	90	7.0	67.5	7.4	1.4	100000	1575	.....	8000	270
3Z4	T-5½	Power Pent.	7BA	1.44 2.84	0.050	.....	Characteristics Same as Type 3Q4.									
4BC5	T-5½	Pentode	7BD	4.2	0.450	2.2	Characteristics Same as Type 6BC5/6CE5.									
4BN4	T-5½	Triode	7EG	4.2	0.300	2.42	Characteristics Same as Type 6BN4.									
4BX8	T-6½	Duodiode	9AJ	4.5	0.600	2.0	Characteristics Same as Type 6BX8.									
4CE5	T-5½	Pentode	7BD	4.2	0.450	2.2	Characteristics Same as Type 6CE5/6CE5.									
4CM4	T-6½	Triode	9KG	3.8	0.300	1.1	Characteristics Same as Type 6CM4.									
4CX7	T-6½	Duodiode	9FC	4.2	0.600	2.2	Characteristics Same as Type 6CX7.									
4DT6	T-5½	Gated Beam	7EN	4.2	0.450	1.65	Characteristics Same as Type 6DT6.									
4GS7	T-6½	Tri. Pentode	9GF	4.0	0.600	2.2	Characteristics Same as Type 7GS7.									
4GW5	T-5½	Triode	7GK	4.2	0.300	2.5	Characteristics Same as Type 6GW5.									
4HA7/4HC7	Comp. T-9	Double Tri.	12FQ	4.2	0.600	2.75	250	8.5	.....	10.5	.....	7700	2200	.....	.....	17
4HR8	T-6½	Pentode	9BJ	4.5	0.300	1.0	250	2.0	.....	1.2	.....	62500	1600	.....	.....	100
							250	2	140	3	0.6	2500	2000	.....	.....	38





TYPE	CONSTRUCTION			EMITTER		USE	Plate Diss. Watts?	Plate Volts	Negative Grid Volts	Screen Volts	Plate Current Ma.	Screen Current Ma.	Screen Current Ma.	Plate Resistance Ohms	Transconductance Micros.	Amplification Factor	Ohms Load (or) Stated Output	Power Output Milliwatts
	Bulb Size or Style	Class	Basing Diag. <sup>1</sup>	Volts	Amps.													
5U4G	ST-16	Duodiode	5T	5.0	3.000	F-W Rect.												
5U4GA	T-11	Duodiode	5T	5.0	3.000	F-W Rect.												
5U4WG(3)	T-12	Duodiode	5T	5.0	3.000	F-W Rect.												
5V3	T-12	Duodiode	5T	5.0	3.800	F-W Rect.												
5Y3GA	T-9	Duodiode	5T	5.0	2.000	F-W Rect.												
GB-5Y3WGTA(3)	T-12	Duodiode	5T	5.0	2.000	F-W Rect.												
5Y4GT	T-9	Duodiode	5Q	5.0	2.000	F-W Rect.												
5Z3	ST-16	Duodiode	4C	5.0	3.000	F-W Rect.												
5Z4GT	Metal T-9	Duodiode	5L	5.0	2.000	F-W Rect.												
6A3	ST-16	Power Triode	4D	6.3	1.000	S.T. A1 Amp. P.P.AB1 Amp. P.P.AB1 Amp.	16.5	250 325 325	45.0 68.0 68.0	100 100 100	1.1 1.1 1.1	50 50 50	1.1 1.1 1.1	300 800 350	3250 3500 3500	4.2	2500 3000 5000	3200 15000 10000
6A7	ST-12	Heptode	7C	6.3	0.300	Converter	1.1	100	1.5	50	3.0	100	3.5	2.7	600000	550*	(Ga = 100V.)	
6A8GT	T-9	Heptode	8A	6.3	0.300	Converter	1.1	100	1.5	50	3.0	100	3.5	2.7	600000	550*	(Ga = 250 V. thru 20 K. Ohm.)	
6AB7	Metal	Pentode	8N	6.3	0.450	Amplifier	4.12	300	3.0	200	12.5	3.2	700000	5000	3500			
6AB8/ECL80	T-6½	Tri. Pentode	6AB8	6.3	0.300	A-F Amp. S.T. A1 Amp.	1.0	100	2.3	170	4	2.8	12500	1400	17	11000	1000	
6AB9	T-6½	Twin Tetrode	10N	6.3	0.365	VHF Amp.	2.0	125	1	80	8	2	110,000	10000				
6AC7	Metal	Pentode	8N	6.3	0.450	Video Amp.	3.3	300	160	150	10.0	2.5	1.0 Meg.	9000	6750			
6AD4	T-3	Triode	8DK	6.3	0.150	Osc. Amp.	0.33	100	820		1.4		35000	2000	70			
6AD6G	T-9	Electron Ray	7AG	6.3	0.150	Indicator												
6AF6G	T-9	Twin Elec. Ray	7AG	6.3	0.150	Indicator												
6AF10	Comp. T-9	Double Pent.	12GX	6.3	1.200	Sound IF Video Amp.	3.0	200	2	150	10	2.5	10000					
6AG5	T-5½	Pentode	7BD	6.3	0.300	R-F Amp.	5.0	200	68	125	22	4	75000	23000				
6AG7	Metal	Pentode	8Y	6.3	0.650	Video Amp.	2.0	100	180	100	4.5	1.4	600000	4500				
6AG10	Comp. T-9	Twin Hex.	12GT	6.3	0.750	Color Demod.	9.9	300	3	150	30.0	7.0	130000	11000				
6AH4GT	T-9	Triode	8EL	6.3	0.750	Defl. Amp.	2.0	40	120	25	5	0.5	10000					
6AJ4	T-5½	Triode	9BX	6.3	0.225	UHF Amp.	7.5	250	23		30		1780	4500	8			
6AJ5	T-5½	Pentode	7BD	6.3	0.175	R-F Amp.	2.2	125	68		16		4200	10000	42			
6AK4	T-3	Triode	8DK	6.3	0.125	UHF Amp.	1.87	28	1.0	28	2.7	1.0	100000	2500				
							3.3	200	680		9.5		5300	3800	20			

6AK6	T-5½	Power Pent.	7BK	6.3	0.150	Power Amp.	3.0	180	9.0	180	15.0	2.5	200000	2300	.....	10000	11000				
6AK8/EABC80	T-6½	Triple Diode Triode	9E	6.3	0.450	Det. Amp.	1.0	250	Average Diode Current Sec. 1 (1 Ma.), Sec. 2 (10 Ma.), Sec. 3 (10 Ma.)									58000	1.2	70	.....
6AK9	Comp. T-12	Double Triode Pent.	12GZ	6.3	1.600	Pent. Vert. Defl. Amp. Tri.#2 per Osc. Tri.#1 Syn. Clip	10.0	150	15.0	150	49.0	3.5	16400	5200	.....	9200	.....				
													14500	350	.....	3500	.....				
													11000	3900	.....	43	.....				
6AL7GT	T-9	Electron Ray	8CH	6.3	0.150	Indicator	.....	315	Grid Volt. for Fluorescent C.O. = -7.0 (App.). Deflection Sens = 1.0 MM. Per Volt (App.)									150000	.....	.....	.....
6AL11	T-9	Duo. Pentode	12BU	6.3	0.900	FM Detector	1.7	150	560	100	1.3	2.1	50000	G3-1000	.....	.....	.....				
													6500	G3-400	.....	.....	4200				
6AM4	T-6½	Triode	9BX	6.3	0.225	UHF Amp.	2.0	200	100	.....	10	.....	8700	9800	.....	85	.....				
6AN6	T-5½	Quadruple Di.	7BU	6.3	0.200	Rectifier	.....	75	Volts RMS Per Plate, 8 Ma. D-C Output Per Plate.									44000	1600	70	.....
6AQ7GT	T-9	Duodiode Tri.	8CK	6.3	0.300	Det. Amp.	1.1	250	2.0	.....	2.3	.....	65000	2400	.....	7600	3.2				
6AR5	T-5½	Power Pent.	6CC	6.3	0.400	Power Amp.	9.35	250	18.5	250	34	5.7	68000	2300	.....	5000	3.4				
													5.5	65000	2300	.....	.....				
6AS6	T-5½	Pentode	7CM	6.3	0.175	R-F Amp.	1.87	120	2.0	120	5.2	3.5	110000	3200	.....	280	70000	2			
6AS7GB	T-12	Duo-Power Triode	8BD	6.3	2.500	Passing Tube for VR Service	14	135	250	125	.....	.....	.....	.....	.....	.....	.....	.....			
													Controlled Zero Bias Plate Current.	.....	.....	.....	.....				
6AU5GT	T-9	Beam Pent.	6CK	6.3	1.250	Horiz. Defl. Amp.	10	.....	Max. Peak Positive Pulse Plate Voltage = 5500 Volts. Max. D.C. Plate Current = 110 Ma.									.....	.....	.....	
6B-6AU6WB (3)	T-5½	Pentode	7BK	6.3	0.300	R-F Amp.	3.5	100	150	100	5.0	2.1	500000	3900	.....	.....	.....				
													250	100	.....	.....	.....				
													250	68	.....	.....	.....				
6AX8	T-6½	Tri. Pentode	9AE	6.3	0.450	S'ync. Sep. Video Amp.	3.97	150	56	.....	18	.....	5000	8500	40	.....	.....				
													250	120	.....	.....	.....				
6AZ5	T-3	Duodiode	8DF	6.3	0.150	Rectifier	.....	.....	Plate Supply Voltage = 50 Volts, RMS, Each Plate, D.C. Output Current = 4 Ma. Each Plate. Capacitor Input to Filter.									.....	.....	.....	
6B3	T-6½	Diode	9BD	6.3	1.200	T.V. Damper	.....	Maximum Peak Inverse Plate Voltage = 4400 Volts. Maximum D.C. Plate Current = 150 Ma.									.....	.....	.....		
6B4G	ST-16	Triode	5S	6.3	1.000	Power Amp.	16.5	.....	Characteristics Same as Type 6A3.									.....	.....	.....	
6B8	Metal	Duodi. Pent.	8E	6.3	0.300	Det. Amp.	3.3	.....	Characteristics Same as Type 6B7, Except Capacitances.									.....	.....	.....	
6BA3	T-9	Diode	9HP	6.3	1.200	T.V. Damper	5.3	.....	Maximum Peak Inverse Plate Voltage = 5000 Volts. Maximum D.C. Output Current = 165 Ma.									.....	.....	.....	
6BA5	T-3	Pentode	8DY	6.3	0.150	A-F Amp.	0.77	100	270	.....	5.5	2.0	175000	2150	.....	.....	.....				
6BA7	T-6½	Heptode	8CT	6.3	0.300	Converter	2.2	100	1.0	100	3.5	10.2	500000	900	.....	.....	.....				
													1.0	100	.....	.....	.....				
6BC5/6CE5	T-5½	Pentode	7BD	6.3	0.300	Tri. Amp.	2.75	250	80	.....	6.0	.....	9000	4000	40	.....	.....				
													320	600	.....	.....	.....				
													100	180	.....	.....	.....				
													125	100	.....	.....	.....				
													250	180	.....	.....	.....				
													.....	.....	.....	.....	.....				
6BD4A	T-12	Beam Triode	8FU	6.3	0.600	Hi-Volt. Reg.	27.5	27000	Max. D.C. Plate Volts. 125 Max. D.C. Grid Volts. 1.5 Ma. Max. D.C. Plate Current.									.....	.....	.....	
6BD5GT	T-9	Beam Pent.	6CK	6.3	0.900	Horiz. Defl. Amp.	11	.....	Max. Peak Positive Pulse Plate Voltage = 4000 Volts. Max. D.C. Cathode Current = 100 Ma.									.....	.....	.....	
6BE8A	T-6½	Tri. Pentode	9EG	6.3	0.450	VHF Osc. VHF Amp.	3.0	250	68	.....	18.0	10.0	3.5	5000	8500	40	.....				
6BF5	T-5½	Pentode	7BZ	6.3	1.200	S.T.A1 Amp.	5.5	110	7.5	110	36	4	12000	7500	2500	1900	.....				

TYPE	CONSTRUCTION		EMITTER		USE	Plate Dis. Watts <sup>1</sup>	Plate Volts	Negative Grid Volts	Screen Volts	Plate Current Ma.	Screen Current Ma.	Plate Resis. Ohms	Transcon-ductance Micros.	Ampli-fication Factor	Ohms Load for Stated Power Output	Power Output Milli-watts
	Bulb Size or Style	Class	Basing Diag. <sup>1</sup>	Volts												
6BF6	T-5½	Duodiode Tri.	7BT	6.3	0.300	Det. Amp.	2.75	250	9.0	9.5	8.0	8500	1900	16	10000	300
6BF7W (3)	T-3	Duodiode	8DG	6.3	0.300	R-F Amp.	1.1	100 100 <sup>#</sup>	.....	8.0	.....	7000	4800	35	.....	.....
6BF8	T-6½	Sextupole Diode	9NX	6.3	0.450	Stunt Detector	.....	.....	.....	.....	.....	.....	.....	.....	.....	.....
6BG6GA	T-12	Beam Pent.	5BT	6.3	0.900	Horiz. Defl. Amp.	22	.....	.....	.....	.....	.....	.....	.....	.....	.....
6BL5	T-5½	Pentode	6CH	6.3	0.640	Power Amp.	9.9	250	5.0	3.5	5.5	40000	10500	450	7000	4000
6BK5	T-6½	Beam Pent.	9BQ	6.3	1.200	Power Amp.	9.9	250	5.0	3.5	0.1 Meg.	8500	.....	.....	6500	3500
6BK11	Comp. T-9	Triple Triode	12BY	6.3	0.600	VHF Amp.	0.4	250 250	2.5 2.0	1.5	.....	45000	1550	70	.....	.....
6BL4	T-12	Diode	8GB	6.3	3.000	T.V. Damper	8.8	F.I.V. = 4500 Volts	.....	.....	.....	.....	.....	.....	.....	.....
6BBBQ7A (3)	T-6½	Twin Triode	9AJ	6.3	0.400	Amplifier	2.3	150 220 <sup>#</sup>	.....	9	.....	5900	6400	38	.....	.....
6BU4	T-12	Triode	8GC	6.3	0.450	H.V. Reg.	27.5	25000	8.4	.....	.....	8.2 Meg.	185	1515	.....	.....
6BU5	T-11	Beam Power Pentode	8FP	6.3	0.150	H.V. Reg.	20	20K 20K	3.4 2.4	1.0 1.0	0.5	.....	.....	.....	.....	.....
6BU8A	T-6½	Duo Pentode	9FG	6.3	0.300	Sync. Sep.	1.1	100 0 Grid 1	67.5	2.2	.....	.....	.....	.....	.....	.....
6BV8	T-6½	Duodiode Tri.	9FJ	6.3	0.600	Det. Amp.	2.7	200 330 <sup>#</sup>	67.5	11.0	.....	5900	5600	33	.....	.....
6BW4	T-6½	Duodiode	9DJ	6.3	0.900	F-W Rect.	.....	325 A.C. Volts Per Plate, RMS, 100 Ma. Output Current.	.....	.....	.....	.....	.....	.....	.....	.....
6BW8	T-6½	Duodi. Pent.	9HK	6.3	0.450	R-F or I-F Amplifier	3.0	250 68 <sup>#</sup>	110	10.0	3.5	250000	5200	.....	.....	.....
6BX6/EF80	T-6½	Pentode	9AQ	6.3	0.300	R-F/I-F Amp.	2.75	170 2.0	170	10	2.5	400000	7200	.....	.....	.....
6BX7GT	T-9	Duodiode	8BD	6.3	1.500	Vert. Amp. Vert. Osc.	11	Max. Peak Positive Pulse Plate Volts = 2000 Volts.	.....	42	.....	1300	7600	10	.....	.....
6BX8	T-6½	Duodiode	9AJ	6.3	0.400	VHF Amp.	2.0	65 1.0	.....	9	.....	6700	25	.....	.....	.....
6BY5GA	T-12	Duodiode	6CN	6.3	1.600	T.V. Damper	.....	P.I.V. = 3000 Volts	.....	.....	.....	.....	.....	.....	.....	.....
6C5GT	T-9	Triode	6Q	6.3	0.300	Amplifier	2.75	250 8.0	.....	8.0	.....	10000	2000	20	.....	.....
6C6	ST-12	Pentode	6F	6.3	0.300	Amplifier	.825	100 3.0	100	2.0	0.5	1 Meg.	1185	.....	.....	.....
6C8G	ST-12	Duodiode	8G	6.3	0.300	Amplifier Inverter	1.1	250 4.5	.....	3.2	.....	22500	1600	36	.....	.....
6C9	T-6½	Duodiode	10F	6.3	0.400	VHF Amp.	2.5	125 1.0	80	10	1.5	100000	8000	.....	.....	.....
6CA4	T-6½	Duodiode	9M	6.3	1.000	F-W Rect.	.....	350 A.C. Volts Per Plate, RMS, 150 Ma. Output Current.	.....	.....	.....	.....	.....	.....	.....	.....
6CA5	T-5½	Beam Pent.	7CV	6.3	1.200	Power Amp.	5.5	110 4.0	110	32	3.5	16000	8100	.....	3500	1100
6CF6	T-5½	Pentode	7CM	6.3	0.300	VHF Amp.	2.3	125 56 <sup>#</sup>	125	12.5	3.7	0.3 Meg.	7800	.....	4500	1500

Maximum Peak Inverse Plate Voltage = 165 Volts. Maximum Peak Plate Current, Per Plate = 11 Ma., Maximum D.C. Output Current = 2.2 Ma.  
 Maximum Peak Positive Plate Voltage = 6600 Volts. Maximum D.C. Cathode Current = 110 Ma.  
 Plate Load 100,000 Ohms, Self-Bias Resistor 1500 Ohms, Voltage Amplification 48.  
 Output Volts 80, RMS for Inverter Service.

6CH7	T-6½	Duotriode	9FC	6.3	0.400	Amplifier	2.2	150	220 <sup>■</sup>	10	5300	6800	36
6CH8	T-6½	Tri. Pentode	9FT	6.3	0.450	Tri. Amp. Pent. Amp.	2.82 2.2	200 200	180 <sup>■</sup>	150	13.0 9.5	3300 6200	19
6CJ3	Novar T-9	Diode	9HP	6.3	1.800	T.V. Damper	6.5	Max. Peak Inverse Pulse Voltage = 5500 Volts.	Max. DC Plate Current = 350 Ma.				
6CK4	T-9	Power Triode	8JB	6.3	1.250	Vert. Defl. Amp.	12	250	28	40	1200	5500	6.5
6CL5	T-12	Beam Pent.	8GD	6.3	2.500	Horiz. Defl. Amp.	27.5	7000	Maximum Peak Positive Pulse Plate Voltage = 2000 Volts. Max. D.C. Cathode Current = 100 Ma. 4.0 Watts Maximum Screen Dissipation.				
6CM4	T-6½	Triode	9KG	6.3	0.170	VHF Amp.	2.2	175	1.5	12	14000	68	
6CM5	T-9	Beam Pent.	8GT	6.3	1.250	Horiz. Defl. Amp.	11	100	7.7	100	7.0	5300	14000
6CQ4	T-9	Diode	4CG	6.3	0.600	T.V. Damper	6.5	Max. Peak Inverse Pulse Voltage = 5500 Volts.	Max. D.C. Plate Current = 190 Ma.				
6CR4	T-6½	Triode	9BX	6.3	0.370	UHF Amp.	.....	130	1.0	16	15000	60	
6CR6	T-5½	Diode Pent.	7EA	6.3	0.300	Det-Audio Amplifier	2.75	250	2.0	100	9.5	3.0	200000
6CR8	T-6½	Tri. Pentode	9GJ	6.3	0.450	Tri. Amp. Pent. Amp.	2.75 2.3	125 125	2.0 58 <sup>■</sup>	125	12.0 13.0	5500 7700	4000 7700
6CS8	T-6½	Tri. Pentode	9FZ	6.3	0.450	Tri. Amp. Pent. Amp.	2.75 2.3	125 125	2.0 56 <sup>■</sup>	125	12.0 13.0	5500 7700	4000 7700
6CX7	T-6½	Duotriode	9FC	6.3	0.400	Amplifier	2.2	150	220 <sup>■</sup>	.....	9.0	6400	39
GB-6CY5 (3)	T-5½	Tetrode	7EW	6.3	0.200	VHF Amp.	2.0	125	1	80	10	2.3	100000
6D4	T-5½	Gas Triode	5AY	6.3	0.250	Relay Tube	.....	350	50	Peak Cathode Current = 100 Ma. Cathode Current = 25 Ma. Approx. Voltage Drop at 25 Ma. = 16 Volts.			
6D6	ST-12	Pentode	6F	6.3	0.300	Amplifier	2.47	100	3.0	100	8.0	2.2	250000
6DA7	T-6½	Duotriode	9EF	6.3	1.000	Sect. 2 Vert. Defl. Amp. Sect. Vert. Osc.	2.2	150 17.5	1.3 6.0	.....	40.0 9.0	100 7700	5700 2600
6DB5	T-6½	Beam Pent.	9GR	6.3	1.200	Vert. Defl. Amp.	11	200	180 <sup>■</sup>	125	46.0	2.2	28000
6DB6	T-5½	Pentode	7CM	6.3	0.300	Color Demod.	3.3	150	1.0	150	5.8	6.6	50000
6DC6	T-5½	Pentode	7CM	6.3	0.300	Amplifier	2.2	200	180 <sup>■</sup>	150	9.0	3.0	500000
6DC8	T-6½	Duodi. Pent.	9HE	6.3	0.300	R-F Amp.	2.47	200	1.5	100	11	3.3	.5 Meg.
6DG6GT	T-9	Beam Pent.	7S	6.3	1.200	Power Amp.	11	110	7.5	110	49	4.0	13000
6DG7	T-6½	Pentode	9BA	6.3	0.300	R-F or I-F Amplifier	3.3	100	68 <sup>■</sup>	100	10.8	4.4	250000
6DHH13	T-3	Twin Triode	8LK	6.3	0.300	R-F Cascode Amp.	1.7	90	1.0	.....	9.0	.....	3800
6B-6DJ8	T-6½	Double Triode	9AJ	6.3	0.365	VHF Amp.	2.1	90	1.3	.....	15	.....	12500
6DL4/EC88	T-6½	Triode	6DL4	6.3	0.165	UHF Amp.	2.0	160	100 <sup>■</sup>	.....	12.5	.....	13500
6DN6	T-12	Beam Pent.	5BT	6.3	2.500	Horiz. Defl. Amp.	16.5	Max. Peak Positive Pulse Plate Voltage = 6600 Volts.	Max. D.C. Cathode Current = 200 Ma.				
6DR4	T-5½	Triode	6BG	6.3	0.150	A-F Amp.	1.2	100	1.0	.....	0.5	.....	8000
								250	2.0	.....	1.2	.....	82500

TYPE	CONSTRUCTION			EMITTER		USE	Plate Diss. Watts	Plate Volts	Negative Grid Volts	Screen Volts	Plate Current Ma.	Screen Current Ma.	Plate Resis. Ohms	Transconductance Micros.	Amplification Factor	Ohms Load for Stated Power Output	Power Output Milli-watts
	Bulb Size or Style	Class	Basing Diag.	Volts	Amps.												
6DS6	T-6½	Beam Pent.	7BZ	6.3	0.800	Power Amp.	9.0	200	180 <sup>■</sup>	200	34.5	3.5	28000	6000	8000	3600	2800
6DT4	T-9	Diode	40C	6.3	1.200	T-V. Damper	7.5	Max. Peak Inverse Plate Voltage = 5500 Volts. Max. D.C. Plate Current = 235 Ma.									
6DW5	T-6½	Beam Pent.	9CK	6.3	1.200	Vert. Defl. Amp.	11	Max. Peak Positive Pulse Plate Voltage = 2200 Volts. Max. D.C. Cathode Current = 65 Ma.									
6DX4	T-5½	Triode	7DK	6.3	0.200	UHF Osc.	2.2	85	150 <sup>■</sup>	10.0	10.0	.....	2700	11000	4.3	.....	.....
6DY4A	T-5½	Triode	7DK	6.3	0.125	UHF Osc.	1.5	90	180 <sup>■</sup>	10.4	10.4	.....	11000	28	.....	.....	.....
6DV5	T-6½	Beam Pent.	9CV	6.3	0.600	S.T. A1 Amp. P.P. A1 Amp.	10	200	13.9	190	45	8.5	24000	7600	4000	4200	4000
6DZ7	T-12	Double Beam Pent.	8JP	6.3	1.920	P.P. AB1 Amp.	13.2	400	11	250	40-100†	4-13†	.....	.....	9000	18000	9000
6DZ8	T-6½	Tri. Beam Pent.	9EX	6.3	0.900	A-F Triode and Pent. Power Amp.	.825	120	1500 <sup>■</sup>	.....	0.8	7-15†	71000	1400	100	.....	.....
6E5	T-9	Electron Ray	6R	6.3	0.300	Indicator	.....	100	(Series Plate Resistor 0.5 Meg. Target Current 1.0 Ma. Grid Bias = 3.3 for 90° Shadow.)				150000	8000	.....	.....	.....
6EA5	T-5½	Tetrad	7EW	6.3	0.200	VHF Amp.	3.25	250	1.0	140	10	0.95	150000	8000	.....	.....	.....
6EB5	T-5½	Duodiode	6BT	6.3	0.300	Low Current Volt./Doublor	.....	Max. Peak Inverse Plate Voltage = 550 Volts.									
6EH4	Comp. T-12	Beam Triode	12FA	6.3	0.200	Hi-Volt. Reg.	30	Maximum D.C. Plate Voltage = 27,000 Volts. Maximum D.C. Grid Voltage = -135 Volts. Maximum D.C. Plate Current = 1.6 Ma.									
6EH8	T-6½	Tri. Pentode	9JG	6.3	0.450	VHF Osc.	2.5	125	1.0	125	13.5	.....	7500	40	.....	.....	.....
6EJ4	Comp. T-12	Beam Triode	12HC	6.3	0.200	Hi-Volt. Reg.	40	Maximum D.C. Plate Voltage = 27,000 Volts. Maximum D.C. Grid Voltage = -135 Volts. Maximum D.C. Current = 1.6 Ma.									
6EL7	T-6½	Pentode	9AQ	6.3	0.300	VHF Amp.	3.0	170	150 <sup>■</sup>	170	10	2.6	.....	9200	.....	.....	.....
6EV7	T-6½	Duodiode	9LP	6.3	0.600	Relay Control Tube	2.5	250	2.0	.....	9.2	.....	11500	5200	60	.....	.....
6EX6	T-12	Beam Pent.	5BT	6.3	2.250	Horiz. Defl. Amp.	22	Max. Peak Positive Pulse Plate Voltage = 7000 Volts. Max. D.C. Cathode Current = 220 Ma.									
6EV6	T-9	Beam Pent.	7S	6.3	0.580	Vert. Defl. Amp.	11	Max. Peak Positive Pulse Plate Voltage = 2500 Volts. Max. D.C. Cathode Current = 60 Ma.									
6F5	Metal T-9	Triode	5M	6.3	0.300	A-F Amp.	.....	250	2.0	.....	0.9	.....	60000	1500	100	.....	.....
6F5GT	T-9	Power Pent.	7S	6.3	0.700	Power Amp. S.T. A1 Amp. P.P. A1 Amp. P.P. AB2 Amp.	12.1	250	16.5	250	34.0	6.5	80000	2500	7000	3200	4800
6FA7	T-6½	Diode Duo Plate Tet.	9MR	6.3	0.300	Frequency Divider	1.5	100	2.2 Meg†	100	3.8	1.7	90000	3200	.....	.....	.....
6FC7	T-6½	Duodiode	9DD	6.3	0.340	VHF Amp.	1.9	90	1.2	.....	15	.....	12000	1450	.....	.....	.....
6FD6	T-5½	Pentode	7BK	6.3	0.330	R-F Amp.	.....	12.6	2.2 Meg†	12.6	1.4	0.5	500000	1450	.....	.....	.....

6FE5	T-6½	Beam Pent.	8KB	6.3	1.200	S.T.A1 Amp. P.P.AB1 Amp.	14.5	130 130	120 <sup>■</sup> 75 <sup>■</sup>	130 130	82-94† 150-154†	4-15† 7.2-17†	0.42	250000	9500	1000 1600†	3500 7000
6FG5	T-5½	Shadow Grid Pent. Triode	7GA	6.3	0.200	VHF Amp.	2.7	250	0.2	250	9						
6FG6/EM84	T-6½	Ind. Tube Twin Triode	6FG6	6.3	0.270	Tuning Ind. Amplifier	0.5	250		250	R <sub>g1</sub> = 3 Meg. E <sub>c1</sub> = 0 to 22 V. I <sub>b</sub> = 0.450 to 0.06 Ma. Target Current = 1.1 to 1.6 Ma. With Deflection Electrode Tied to Triode Plate.						
6FR7	9-T9	Duotriode	9HF	6.3	0.925	Vert. Defl. Amplifier	10	150 20	20	50	50	7200 7200	5.4 5.4	40000	1600	68	
6FW5	T-12	Beam Pent.	6CK	6.3	1.200	Horiz. Defl. Amplifier	18	250	3.0	1.4	1.4			6500 Volts.	Max. D.C. Cathode Current = 175 Ma.		
6FW7	T-3	Twin Triode	8LM	6.3	0.300	VHF Osc. VHF Mixer		90 1		7.0 9.0				6000 3800	6000 9500	36 36	
6FW8	T-6½	Duotriode	9AJ	6.3	0.400	VHF Amp.	2.2	100	1.2	15	33			3800	9500	36	
6FX7/6DHH13	T-3	Twin Triode	8LK	6.3	0.300	VHF Amp.	1.7	90	1	9.0				3800	9500	36	
6GA7	T-12	Diode Pent.	12EB	6.3	2.260	T.V. Damper Horiz. Amp.	5.0	250	22.5	2.4	20000	6600		6500 Volts.	Max. D.C. Cathode Current = 140 Ma.		
6GC6	T-12	Beam Pent.	8JX	6.3	1.200	Power Amp.	17.5	250	22.5	150	75	2.4	20000	6600			
6GD7	T-6½	Triode Pent.	9GF	6.3	0.380	VHF Osc. VHF Mixer	2.2	125	1.0	15	4700	10000	47	350000	12000	70	
6GE8	T-6½	Tri. Pentode	9LC	6.3	0.900	Passing and Control Tube For V.R. Use	7.0	150	21	70	5.5	1.7	340000	5000	3200	5.4	
6GJ8	T-6½	Tri. Pentode	9AE	6.3	0.600	Gen. Purpose Horiz. Osc.	2.5	125	1.0	125	13.5	4.5	150000	5000	7500	40	
6GK7	T-6½	Pentode	9AQ	6.3	0.300	T.V. I-F Amp.	2.8	135	82 <sup>■</sup>	135	7	3.5	275	9500			
6GM8	T-6½	Duotriode	9AJ	6.3	0.330	R-F Amp. Osc. Mixer	.66	12.6	0.1 Meg <sup>†</sup> 12.6 0.22 Meg <sup>†</sup>	1.0	2.5		3400	4600	1300 <sup>▲</sup>		
6GN6	T-5½	Pentode	7FW	6.3	0.300	R-F Amp.	3.3	100	68 <sup>■</sup>	100	10.8	4.4	250000	4300			
6GS7	T-6½	Triode Pentode	9GF	6.3	0.365	Oscillator Mixer	1.5	100	3.0	14	3100	5500	17	350000	12000		
6GV7	T-6½	Triode Pent.	9KN	6.3	0.350	VHF Osc. VHF Mixer	T2.0 P2.0	100 125	1.5	125	10	3.1		5.5 Ma/V 11 Ma/V	50		
6GW5	T-5½	Triode	7GK	6.3	0.190	VHF Amp.	2.5	135	1	12.5			5800	15000	70		
6H6, 6H6GT	T-9	Duotriode	7Q	6.3	0.300	Rectifier		117 A.C. Volts Per Plate, RMS, 8.0 Ma. Output Current Per Plate.									
6HA6	T-6½	Pentode	9NW	6.3	0.710	Video Amp.	8.0	150	33 <sup>■</sup>	100	28	3.5	20000	20000	31		
6HC8	9-T9	Tri. Pentode	9EX	6.3	1.200	Vert. Defl. Amplifier	11	250	18	250	38	3	55000	5100	68		
6HD5	Comp. T-12	Beam Pent.	12ES	6.3	2.280	Horiz. Defl. Amp.	24	135	22	135	65	4	5000	10000	4.2		
6HL5	T-6½	Beam Pent.	9QW	6.3	0.950	Power Amp.	12.0	140	5.7	140	68.5	14.5			1700	4000	
6HQ6	T-5½	Pentode	6HO6	6.3	0.300	VHF Amp.	2.4	125	56 <sup>■</sup>	125	15	3.8	220000	10500			
6HU6/EM87	T-6½	Electron Ray	9GA	6.3	0.300	Indicator	0.6	250									

(Control Voltage = 10 Volts (to Close Light Pattern))

TYPE	CONSTRUCTION		EMITTER		USE	Plate Diss. Watts	Plate Volts	Negative Grid Volts	Screen Volts	Plate Current Ma.	Screen Current Ma.	Plate Resis. Ohms	Transconductance Micros.	Amplification Factor	Ohms Load for Stated Power Output	Power Output Milli-watts
	Bulb Size or Style	Class	Basing Diag. 1	Volts												
6HV5	Comp. T-12	Beam Triode	12GY	6.3	1.8	Hi-Volt. Reg.	30	Maximum Peak Plate Voltage = 5500 Volts. Peak 3500 4.4	300	300	Maximum Peak Plate Current = 325 Ma.	4600	65000	300		
6HW8	T-6½	Duo. Plate Sheet Beam	9NQ	6.3	0.300	Duo. Plate Sheet Beam	2.0	270 <sup>m</sup> Defl. Switching Voltage = 40 Volts Max.	250	13	1.4	4000	4000	30		
6L4	T-5½	Triode	7BQ	6.3	0.400	Amplifier	2.5	150 100 <sup>m</sup>	15.0	15.0	4500	12000	55			
6B-6J4WA (3)																
6J5GT	T-9	Triode	6Q	6.3	0.300	Amplifier	2.75	250	9.0	9.0	7700	2600	20			
6J6WA (3)	T-5½	Duotriode	7BF	6.3	0.450	VHF Osc.	1.65	150 10.0	30.0	30.0	Push-Pull Class C Operation	7100	5300	38		3500
				6.3	0.450	VHF Amp. Mixer	150 82 <sup>m</sup>	50 <sup>m</sup>	8.5	4.8	10000	1900 <sup>4</sup>				
6J7GT	T-9	Pentode	7R	6.3	0.300	A-F Amp.	1.92	250 3.0	100	2.0	0.5	1.0 Meg <	1225			
6JG6	T-12	Beam Pent.	9QU	6.3	1.600	Horiz. Defl. Amp.	17	Characteristics Same as Type 6JG6A Except for Bulb Construction.								
6JL8	T-6½	Triode Pent.	9DX	6.3	0.750	Voltage Amp. Power Amp.	2.0 5.0	150 300 3.5	150	10	7.5	7500	4700	35		1800
6JQ6	T-6½	Beam Pent. Diode	9RA	6.3	1.200	Vertical Defl. Amplifier	10.0	Maximum Peak Positive Plate Voltage = 2000 Volts. Maximum D.C. Cathode Current = 70 Ma.	140 18.0	35.0	2.5	10500	4200			
6JR6	Novar T-12	Beam Pent.	9QU	6.3	1.6	Horiz. Defl. Amplifier	17	Maximum Peak Positive Plate Voltage = 6500 Volts. Maximum D.C. Cathode Current = 275 Ma.	130 20	125 45	1.5	18000	7000	4.7		
6JU8	T-6½	Quadruple Diode	9PQ	6.3	0.600	Color Det., FM Multiplex Det.		Characteristics Same as Type 6JU8A Except for Bulb Construction.								
6JY8	T-6½	Triode Pentode	9DX	6.3	0.750	Sync. Sep. Video Amp.		125 68 <sup>m</sup>	15	15	4400	10400	46			
6K7	Metal	Pentode	7R	6.3	0.300	R-F Amp.	3.0	100 200 3.0 250	100 9.5 7.0 10.5	2.7	150000 80000 60000 6500	1500 1500 1500 1550				
6K8	Metal	Tri. Hexode	8K	6.3	0.300	Mixer Osc.	.825	250 3.0 100	100 2.5 6.0	600000 350 <sup>4</sup>						
6KE6	Comp. T-12	Beam Pent.	12GM	6.3	1.500	Horiz. Defl. Amplifier	18.0	130 20	130	50	1.75	11000	9100	4.7		
6KF8	T-6½	Double Pent.	9FG	6.3	0.300	Sync. Sep. AGC Amp.	1.1	100 G3 = -10	67.5	2.8	8.4	Ik = 8.5 Ma.				
6KL8	T-6½	Diode Pent.	9LQ	6.3	0.300	Detector R-F L-F Amp.	3.0	100 2.2 Meg. 100	6.5	5.5	2.2	550000	4300			
6KT6	T-6½	Pentode	9PM	6.3	0.300	IF Amp.	3.1	125 56 <sup>m</sup>	125	17	4.2	160000	18000			
6KV6	T-12	Beam Pent.	9QU	6.3	1.600	Shunt Reg.	20	Max. DC Plate = 6500 Volts. Max. DC Grid Voltage = 75 Volts. Max. DC Cathode Current = 275 Ma.								
6KY6	T-6½	Pentode	9GK	6.3	0.520	Video Amp.	9.0	200 47 <sup>m</sup>	135	30	5.2	40000	30000			
6L7	Metal	Heptode	7T	6.3	0.300	Mixer Amp. Amplifier	1.65	250 6.0	150 3.3	9.2	1 Meg. <	350 <sup>4</sup>				
				6.3	0.300		250	3.0	100	5.3	6.5	600000	1100			



6LG6, A	Comp. T-12	Beam Pent.	12HL	6.3	2.0	Horiz. Defl. Amplifier	28.0	175	23	125	90	1.7	7500	11500	3.6	Maximum D.C. Cathode Current = 315 Ma.		
6LJ6A/6LH6A	T-12	Beam Triode	8MQ	6.3	0.20	Hi-Volt. Reg.	40	Maximum D.C. Plate Voltage = 27,000 Volts.	Maximum D.C. Plate Current = 1.6 Ma.	200	2	4	17000	4000	70	Maximum D.C. Grid Voltage = -135 Volts.		
6LP8	T-6½	Triode	9DX	6.3	0.600	Gen. Purpose Video Amp.	3.75	100	2.5	150	20	5	200000	11000	.....	.....		
6LQ6	Novar T-12	Beam Pent.	9QL	6.3	2.300	Horiz. Defl. Amplifier	30.0	Maximum Peak Positive Plate Voltage = 7500 Volts.	Maximum D.C. Cathode Current = 350 Ma.	175	35	145	95	2.4	7000	7500		
6LR6	Comp. T-12	Beam Pent.	12FY	6.3	2.500	Horiz. Defl. Amplifier	30	Maximum Peak Positive Plate Voltage = 7500 Volts.	Maximum D.C. Cathode Current = 375 Ma.	175	20	110	140	2.4	5300	16000	3.5	
6LV6	Comp. T-12	Beam Pent.	12GW	6.3	2.000	Horiz. Defl. Amp.	40	Max. Peak Positive Plate Voltage = 800 Volts.	.....	.....	.....	.....	.....	.....	.....	.....	.....	
6ML8	T-6½	Triple Triode	9RQ	6.3	0.675	Color Dif. Amplifier	5.0 Tot. 2.0 ea.	125	1.0	.....	.....	11.0	.....	6400	6700	43	.....	
6MN8	Comp. T-9	Triple Triode	12HU	6.3	0.900	Chroma Matrix Amplifier	3.0	125	1.0	.....	.....	11.0	.....	6250	7500	47	.....	
6MQ8	T-6½	Triode Pent.	9AE	6.3	0.535	Pentode Amp. Triode Amp.	2.5 2.7	125 150	62 56	125 18.0	4.5	.....	.....	15000	10000	40	.....	
6N7GT	T-9	Duotriode	8B	6.3	0.800	Power Amp. Driver	1.1	300	0.0	.....	.....	17.5-35†	Per Pl. Ci. B. Push-Pull Oper. Zero Sig.	8000†	10000	.....	.....	
6Q7GT	T-9	Duodiode Tri.	7V	6.3	0.300	Det. Amp.	0.55	100	1.5	.....	.....	0.8	.....	58000	1200	70	.....	
6R7	Metal	Duodiode Tri.	7V	6.3	0.300	Det. Amp.	2.75	250	3.0	.....	.....	1.1	.....	58000	1200	70	.....	
6RA6	T-6½	Triode	.....	6.3	0.900	A-F Pre-Amp.	10	250	12	.....	.....	21	.....	8500	1900	16	.....	
6RAL1	T-6½	Twin Triode	9HF	6.3	0.860	Vert. Defl. Osc.	1.5	250	11	.....	.....	5.0	.....	2000	17.5	.....	.....	
6RH8/6KN8	T-6½	Twin Triode	9AJ	6.3	0.400	VHF Amp.	2.2	110	1	.....	.....	16	.....	2800	16000	45	.....	
6RK19/6BR3	T-6½	Diode	9CB	6.3	1.200	T.V. Damper	6.5	Max. Peak Inverse Plate Voltage = 5500 Volts.	Max. D.C. Plate Current = 200 Ma.	250	8	250	54	6.8	32000	11000	4000	.....
6RP15	T-6½	Beam Pent.	.....	6.3	0.750	A-F Amp.	13.5	250	.....	.....	.....	.....	.....	.....	.....	.....	.....	.....
6RP22	T-6½	Beam Pent.	9BV	6.3	0.650	Video Amp.	7.5	250	3	150	22	8.5	55000	8500	.....	.....	.....	.....
6SA7	Metal	Heptode	8R	6.3	0.300	Converter	1.1	100	2.0	100	3.3	8.5	500000	425*	.....	.....	.....	.....
6SA7GT	T-9	.....	8AD	6.3	.....	.....	.....	250	2.0	100	3.5	8.5	1.0 Meg.	450*	.....	.....	.....	.....
6SB7Y	Metal	Heptode	8R	6.3	0.300	Converter	2.2	250	1.5	100	4.0	8.5	.....	880*	.....	.....	.....	.....
6SC7	Metal	Duotriode	8S	6.3	0.300	Amplifier	.....	250	2.0	.....	2.0	.....	53000	1325	70	(Each Triode)	.....	.....
6SF5	Metal	Triode	6AB	6.3	0.300	A-F Amp.	.....	250	2.0	.....	0.9	.....	66000	1500	100	.....	.....	.....
6SF7	Metal	Diode Pent.	7AZ	6.3	0.300	Det. Amp.	3.85	100	1.0	100	12	3.4	200000	1975	.....	.....	.....	.....
6SG7	Metal	Pentode	8BK	6.3	0.300	R-F Amp.	3.3	100	1.0	100	8.2	3.2	250000	4100	.....	.....	.....	.....
6SH7	Metal	Pentode	8BK	6.3	0.300	R-F Amp.	3.3	100	1.0	150	1.5	4.4	90000	4700	.....	.....	.....	.....
6SJ7WG(3)	T-9	Pentode	8N	6.3	0.300	A-F Amp.	2.8	100	3.0	100	2.0	0.9	700000	1575	.....	.....	.....	.....
GB-6SJ7WG(3)	.....	.....	.....	.....	.....	.....	.....	250	3.0	100	3.0	0.8	1.0 Meg	<	.....	.....	.....	.....
Ruggedized Version. Low Loss Base.																		

TYPE	CONSTRUCTION		EMITTER		USE	Plate Diss. Watts:	Plate Volts	Negative Grid Volts	Screen Volts	Plate Current Ma.	Screen Current Ma.	Plate Resis. Ohms	Transcon-ductance Micros.	Ampli-fication Factor	Ohms Load	Power Output Milli-watts	
	Bulb Size or Style	Class	Basing Diag.	Volts													Amps.
GB-6SL7WG(3)	T-9	Duotriode	88D	6.3	0.300	Amplifier	1.1	250	2.0	2.3	...	44000	1600	70	....	....	
GB-SN761A (3)	T-9	Duotriode	88D	6.3	0.600	Amplifier	2.75	90	0	10.0	...	6700	3000	20	....	....	
							250	250	8.0	9.0	...	7700	2600	20	....	....	
6SR7	Metal	Duodiode Tri.	8Q	6.3	0.300	Det. Amp.	2.75	250	9.0	9.5	...	8500	1900	16	....	....	
6SS7	Metal	Pentode	8N	6.3	0.150	R-F Amp.	2.5	100	1.0	12.2	3.1	120000	1950	....	....	....	
							250	3.0	100	9.0	2.0	1000000	1850	....	....	....	
6T9	Comp. T-9	Triode Pent.	12FM	6.3	0.930	A-F Volt. Amp. A-F Pwr. Amp.	1.5	250	2	250	39.0	45000	2100	95	....	4200	
6U5	T-9	Electron Ray	6R	6.3	0.300	Indicator	....	100	(Series Plate Res. 0.5 Meg, Target Current 1.0 Ma., Grid Bias -8.0 for 0° Shadow.)	....	....	....	....	....	5000	4200	
							250	(Series Plate Res. 1.0 Meg, Target Current 4.0 Ma., Grid Bias -22.0 for 0° Shadow.)	....	....	....	....	....	....	....	....	....
6U6GT	T-9	Beam Pent.	7S	6.3	0.750	Power Amp.	12.1	110	10.5	110	44.0	10000	5600	....	2000	2000	
							200	14.0	135	56.0	3.0	20000	6200	....	3000	5500	
6V4/EZ80	T-6½	Duodiode	9M	6.3	0.600	F-W Rect.	....	350	Volts A.C. Per Plate (RMS), 90 Ma Output Current. (Condenser Input to Filter.)	....	....	....	....	....	....	....	....
6V8	T-6½	Triple Diode Triode	9AH	6.3	0.450	Det. Amp.	1.1	100	1.0	....	0.8	54000	1300	70	....	....	
							250	3.0	....	1.0	....	58000	1200	70	....	....	
GB-6X4WA (3)	T-5½	Duodiode	5BS	6.3	0.600	F-W Rect.	....	400	Volts RMS Per Plate, 55 Ma. D.C. Output	....	....	....	....	....	....	....	....
6X5WG(3)	T-9	Duodiode	6S	6.3	0.600	F-W Rect.	....	325	A.C. Volts Per Plate, RMS, 70 Ma. Output Current. Condenser Input to Filter.	....	....	....	....	....	....	....	....
GB-6X5WG(3)	T-9	Duodiode	6S	6.3	0.600	F-W Rect.	....	450	A.C. Volts Per Plate, RMS, 70 Ma. Output Current. Choke Input to Filter.	....	....	....	....	....	....	....	....
6Z4/84	ST-12	Duodiode	5D	6.3	0.500	F-W Rect.	....	325	A.C. Volts Per Plate, RMS, 60 Ma. Output Current. Condenser Input to Filter.	....	....	....	....	....	....	....	....
							2.75	90	0.0	....	10.0	6700	3000	20	....	....	
7A4/XXL	Lock-in	Triode	5AC	6.3	0.300	Amplifier	2.75	250	8.0	....	9.0	7700	2600	20	....	....	
7A5	Lock-in	Beam Pent.	6AA	6.3	0.750	Power Amp.	6.0	110	7.5	110	40.0	3.0	15000	5800	....	1500	
							....	125	9.0	125	44.0	3.3	17000	6000	....	2700	
7A6	Lock-in	Duodiode	7DX	6.3	0.150	Det. Rect.	....	150	A.C. Volts Per Plate, RMS, 8 Ma. Current Output Per Plate.	....	....	....	....	....	....	....	....
7A7	Lock-in	Pentode	8V	6.3	0.300	R-F Amp.	4.4	100	1.0	100	13.0	4.0	120000	2350	....	....	
							....	250	3.0	100	9.2	2.6	800000	2000	....	....	
7A8	Lock-in	Octode	8U	6.3	0.150	Converter	1.1	100	3.0	75	1.8	2.7	650000	375*	(Ga = 100 V, 2.8 Ma.)	....	
							....	250	3.0	100	3.0	3.2	700000	550*	(Ga = 250 V thru 20K Ohms.)	....	
7AF7	Lock-in	Duotriode	8AC	6.3	0.300	Amplifier (per unit)	2.75	100	0	....	10.8	....	6500	2600	17	....	
							....	100	3.0	....	5.0	....	8400	1900	16	....	
							250	10	....	9.0	....	7600	2100	16	....	....	
7AG7	Lock-in	Pentode	8V	6.3	0.150	R-F Amp.	2.2	250	250 <sup>■</sup>	250	6.0	2.0	1.0 Meg <	4200	....	....	
7AK7	Lock-in	Pentode	8V	6.3	0.800	R-F Amp.	9.35	150	0	90	40	21	11500	6000	....	....	
GB-7AK7 (3)	Lock-in	Pentode	8V	6.3	0.800	R-F Amp.	150	11	0	90	2.5 Max.	0.45	....	....	....	....	
							....	150	0	90	2.0 Max.	60 Max.	....	....	....	....	
7B4	Lock-in	Triode	5AC	6.3	0.300	Amplifier	....	100	1.0	....	0.4	....	85000	1150	100	....	
							....	250	2.0	....	0.9	....	66000	1500	....	....	

7B5	Lock-in	Power Pent.	6AE	6.3	0.400	Power Amp.	9.35	100	7.0	100	9.0	1.6	104000	1500	12000	350	
								100	18.0	250	32.0	5.5	68000	2300	7600	3400	
								315	21.0	250	25.5	4.0	75000	2100	9000	4500	
7B6	Lock-in	Duodiode Tri.	8W	6.3	0.300	Det. Amp.	0.55	100	1.0	.....	0.4	.....	110000	900	100	.....	
								250	2.0	.....	0.9	.....	110000	1100	100	.....	
7B7	Lock-in	Pentode	8V	6.3	0.150	R-F Amp.	2.47	100	3.0	100	8.2	1.8	300000	1675	.....	.....	
								250	3.0	100	8.5	1.7	750000	1750	.....	.....	
7B8	Lock-in	Heptode	8X	6.3	0.300	Converter	1.1	100	1.5	50	1.1	.....	600000	350*	(Ca = 100 V, 2.0 Ma.)	.....	
								250	3.0	100	3.5	2.7	360000	550*	.....	.....	
7C5	Lock-in	Beam Pent.	6AA	6.3	0.450	Power Amp. Class A1	13.2	180	8.5	180	29.0	3.0	58000	3700	5500	2000	
								250	12.5	250	45.0	4.5	52000	4100	5000	4500	
								315	13.0	225	34.0	2.2	70000	3750	8500	5500	
								250	13.0	250	70-79†	5-13‡	(Class AB1 Two Tubes)	10000†	10000	10000	
								285	19.0	285	70-92†	4-13.5†	(Class AB1 Two Tubes)	8000†	8000†	14000	
7C6	Lock-in	Duodiode Tri.	8W	6.3	0.150	Det. Amp.	0.66	100	0.0	.....	1.0	.....	100000	850	85	.....	
								250	1.0	.....	1.3	.....	100000	1000	100	.....	
7C7	Lock-in	Pentode	8V	6.3	0.150	R-F Amp.	1.1	100	3.0	100	1.8	0.4	1.2 Meg.	1225	.....	.....	
								250	3.0	100	2.0	0.5	2.0 Meg.	1300	.....	.....	
7E58	T-6½	Duodiode	9AJ	7.2	0.300	VHF Amp.	1.8	90	1.4	.....	15	.....	2500	12500	.....	.....	
7EY6	T-9	Beam Pent.	7S	7.2	0.600	Vert. Defl. Amplifier	11	Max. Peak Positive Pulse Plate Voltage = 2500 Volts. Max. D.C. Cathode Current = 60 Ma. Characteristics Same as Type 6F7C.	.....	.....	.....	.....	.....	.....	.....	.....	.....
								250	17.5	250	44	3.0	60000	4400	.....	.....	
7F7	Lock-in	Duodiode	8AC	6.3	0.300	A-F Amp.	1.1	100	1.0	.....	0.65	.....	62000	1125	70	.....	
								250	2.0	.....	2.3	.....	44000	1600	70	.....	
7F8	Lock-in	Duodiode	8BW	6.3	0.300	Osc. Amp.	3.85	250	500 <sup>■</sup>	.....	6.0	.....	3300	48	.....	.....	
GB-7F8W (3)	Lock-in	Duodiode	8BW	6.3	0.300	Osc. Amp.	3.5	250	200 <sup>■</sup>	.....	11.0	.....	5200	50	.....	.....	
7FC7	T-6½	Duodiode	9DD	7.2	0.300	VHF Amp.	1.9	Characteristics Same as Type 6F7C.	.....	.....	.....	.....	.....	.....	.....	.....	
7G7	T-9	Pentode	8V	6.3	0.450	Amplifier	.....	250	2.0	100	6.0	2.0	800000	4500	.....	.....	
7GS7	T-6½	Tri. Pent.	9GF	7.6	0.300	IF Amp.	1.5	100	3	.....	14	.....	5500	17	.....	.....	
								2.2	170	1.2	150	10	3.3	350000	12000	.....	
7GV7	T-6½	Triode Pent.	9KN	7.4	0.300	VHF Osc. VHF Mixer	2.0	Characteristics Same as Type 6GV7.	.....	.....	.....	.....	.....	.....	.....	.....	
								2.75	100	1.5	100	7.5	2.6	350000	4000	.....	
								2.75	250	180 <sup>■</sup>	150	10.0	3.2	800000	4000	.....	
7H7	Lock-in	Pentode	8V	6.3	0.300	R-F Amp.	2.75	100	1.5	100	7.5	2.6	350000	4000	.....	.....	
7J7	Lock-in	Tri. Heptode	8BL	6.3	0.300	Hep. Mixer	0.55	100	3.0	100	1.5	2.6	500000	280*	.....	.....	
								250	3.0	100	1.4	2.8	1.5 Meg.	250*	.....	.....	
								1.74	100	0.05 Meg.	3.2	.....	(Triode Grid Current 0.3 Ma.)	.....	.....	.....	
								250	0.05 Meg.	.....	5.0	.....	(Triode Grid Current 0.4 Ma.)	.....	.....	.....	
7K7	Lock-in	Duodiode Tri.	8BF	6.3	0.300	Det. Amp.	1.1	250	2.0	.....	2.3	.....	44000	1600	70	.....	
7KY6	T-6½	Pentode	9GK	7.3	0.450	Video Amp.	.....	Characteristics Same as 6KY6.	.....	.....	.....	.....	.....	.....	.....	.....	
7KZ6	T-6½	Pentode	9GK	7.3	0.450	Video Amp.	9.0	250	75 <sup>■</sup>	115	25.0	3.6	45000	24000	.....	.....	
7L7	Lock-in	Pentode	8V	6.3	0.300	R-F Amp.	4.4	100	1.0	100	5.5	2.4	100000	3000	.....	.....	
								250	1.5	100	4.5	1.5	1.0 Meg.	3100	.....	.....	
7MP18	T-5½	Beam Pent.	7BZ	7.5	0.600	Power Amp.	7.5	200	5	180	35	5.5	24000	11000	5000	3200	
7N7	Lock-in	Duodiode	8AC	6.3	0.600	Amplifier	2.75	90	0.0	.....	10.0	.....	6700	3000	20	.....	
								250	8.0	.....	9.0	.....	7700	2600	20	.....	



10AL11	Comp. T-9	Duo. Pentode	12BU	9.8	0.600	FM Det. ST A1 Amp.	1.7	Characteristics Same as Type 6AL11.						
10C8	T-6½	Tri. Pentode	9DA	10.5	0.300	Tri. Amp. Pent. Amp.	2.0 2.2	250 135	390 <sup>µ</sup> 100 <sup>µ</sup>	7.3 135	12000 190000	4400 8000	53	
10DA7	T-6½	Duotriode	9EF	10.5	0.600	Vert. Osc. Vert. Defl. A.	2.2	Characteristics Same as Type 6DA7.						
10FR7	9-T9	Duotriode	9HF	9.7	0.600	Vert. Defl. Amp./Osc.	6.5 1.5	Characteristics Same as Type 6FR7.						
10HA6	T-6½	Pentode	9NW	10.4	0.450	Video Amp.	8.0	Characteristics Same as Type 6HA6.						
11BM8	T-6½	Triode Pentode	9EX	10.7	0.450	Osc. and Audio Amp.	1.0	Characteristics Same as Type 6BM8/ECL82.						
11BT11	Comp. T-9	Double Tri. Pentode	12GS	10.7	0.600	Video Amp.	1.5 2.0 3.5	200 200 150	270 <sup>µ</sup> 470 <sup>µ</sup> 82 <sup>µ</sup>	7.1 7.2 17.4	12500 7600 19000	5500 3000 40	69 40	
11CF11	Comp. T-9	Dble. Triode Pentode	12HW	10.7	0.600	Cath. Foll., Video Amp. Frame Grid Video Amp.	2.0 1.5 5.0	200 200 200	5.5 6.3 5.0	7.1 7.6 27.5	12400 9200 490000	5500 6300 21200	69 59	
11DS5	T-5½	Beam Pent.	7BZ	11.2	0.450	A-F Output	9.0	Characteristics Same as Type 6DS5.						
11MS8	T-6½	Triode Beam Pent.	9LY	11.6	0.450	Tri. Vert. Pent. Vert. Defl. Amp.	0.5 6.0	100 120	0.85 10	5 50	11000 13000	5500 8500	60 5.8	
12A6	Metal T-9	Beam Pent. Heptode	7S	12.6	0.150	Power Amp. Converter	8.25 1.1	250 12.5	250 12.5	280 30	70000 3000	3000 7500	3400	
12AC6	T-5½	Pentode	7BK	12.6	0.150	R.F. Amp.	.....	12.6	0	12.6	550 <sup>µ</sup>	200 <sup>µ</sup>	0.5 Meg.	730
12AD5	T-6½	Pentode	9AZ	12.6	0.100	R-F Amp.	2.2	100	2.5	100	6.0	600000	2200	.....
12AD7	T-6½	Duotriode	9A	12.6/6.3	0.225/0.450	A-F Amp.	1.1	250	2	.....	1.25	62500	1600	100
12AE7	T-6½	Duotriode	9A	12.6	0.450	Dis. Triodes Voltage Amp. Pwr. Amp. Dr.	1.0 1.0	12.6 12.6	1.5 1.0 Meg <sup>†</sup>	.....	1.9 7.5	3150 985	4000 6500	13 6.4
12AE10	Comp. T-9	Double Pent. Tri. Tetrode	12EZ	12.6	0.450	FM-Det. Audio Output	6.0 1.7	145 150	7.0 560 <sup>µ</sup>	110 100	39 2.0	33000 150000	5600 1000	2500
12AG6	T-5½	Heptode	7CH	12.6	0.150	Converter	.....	12.6	0.85	12.6	0.55	1.4	.....	300* GI = 20000 Ohms; GI = 0.050 Mh.
12AJ6	T-5½	Duodiode Tri. Tri. Amp.	7BT	12.6	0.150	Det. Amp.	.....	12.6	0	.....	.075	45000	1200	55
12AL8	T-6½	Tri. Tetrode	9GS	12.6	0.550	Tri. Amp. Tet. Amp.	.....	12.6	0.9†	.....	0.5	13000	1000	13
12AL11	Comp. T-9	Duo. Pent. Beam Pent. Tri. Tetrode	12BU	12.6	0.450	FM Det. S.T. A1 Amp.	1.7	.....	.....	.....	.....	480	15000	.....
12AS5	T-5½	Beam Pent.	7CV	12.6	0.400	S.T. A1 Amp.	6.0	Characteristics Same as Type 6AS5.						
12AT7WA (3)	T-6½	Duotriode	9A	6.3 12.6	0.300 0.150	VHF Amp.	2.5	100	270 <sup>µ</sup>	.....	3.7	15000	4000	60
12AW6	T-5½	Pentode	7CM	12.6	0.150	R-F Amp.	2.2	250	200 <sup>µ</sup>	.....	10.0	10900	5500	60
							2.2	250	200 <sup>µ</sup>	150	7.0	2.0	0.8 Meg.	5000
							125	125	100 <sup>µ</sup>	125	7.2	2.1	0.5 Meg.	5100
							100	100	100 <sup>µ</sup>	100	5.5	1.6	0.3 Meg.	4750

TYPE	CONSTRUCTION		EMITTER		USE	Plate Diss. Watts	Plate Volts	Negative Grid Volts	Screen Volts	Plate Current Ma.	Screen Current Ma.	Plate Resis. Ohms	Transconductance Micros.	Amplification Factor	Ohms Load for Stated Power Output	Power Output Milli-watts	
	Bulb Size or Style	Class	Basing Diag.	Volts													Amps.
12A7	T-6½	Duotriode	9A	12.6	0.150	1.65	250	4.0	3.0	3.0	1750	40	40	1750	40	300	
12B3	T-6½	Diode	9B	12.6	0.600	6.0	Characteristics Same as Type 6B3.										
12B4A	T-6½	Triode	9AG	6.3/12.6	0.600/0.300	6.0	Max. Peak Pos. Pulse Plate Voltage = 1000 Volts Max. D.C. Cathode Current = 30 Ma. (12B4A Designed for Series String Receivers.)										
12B7	T-6½	Diode	9B	12.6	0.300	150	17.5	35	6500	6.5	6500	6.5	6500	6.5	6500	6.5	
12BA7	T-5½	Heptode	8C	12.6	0.150	2.2	Characteristics Same as Type 6BA7.										
12BF6	T-5½	Duodiode Tri.	7B	12.6	0.150	2.75	250	9.0	9.5	8500	1900	16	10000	16	10000	300	
12BJ3	Comp. T-9	Diode	12B	12.6	0.450	5.3	Max. Peak Inverse Plate Voltage = 3300 Volts. Max. Cathode Current = 165 Ma.										
12BK5	T-6½	Beam Amp.	9B	12.6	0.600	9.9	Characteristics Same as Type 6BK5.										
12BT3	Comp. T-9	Diode	12B	12.6	0.450	.....	Max. Peak Inverse Plate Voltage = 3300 Volts Max. DC Output Current = 165 Ma.										
12BV7	T-6½	Pentode	9BF	12.6/6.3	0.300/0.600	6.87	250	68	150	27	6.0	85000	13000	1000	.....	.....	
12BW4	T-6½	Duodiode	9DJ	12.6	0.450	.....	Characteristics Same as Type 6BW4										
12BX6	T-6½	Pentode	9AQ	12.6	0.150	2.5	Characteristics Same as Type 6BX6.										
12BY3	T-6½	Diode	9CB	12.6	0.450	4	Max. Peak Inverse Plate Voltage = 4500 Volts Max. DC Output Current = 140 Ma.										
12C8	Metal	Duodi. Pent.	8E	12.6	0.150	2.47	Characteristics Same as Type 6B8.										
12CA5	T-5½	Beam Pent.	7CV	12.6	0.600	5.5	Characteristics Same as Type 6CA5.										
12CN5	T-5½	Pentode	7CV	12.6	0.450	I-F Amp.	.....	12.6	2.2 Meg <sup>1</sup>	12.6	4.5	0.35	40000	3800	.....	.....	
12CR6	T-5½	Diode Pent.	7EA	12.6	0.150	2.75	250	2	100	9.6	2.6	800000	2200	.....	.....	.....	
12CT8	T-6½	Tri. Pentode	9DA	12.6	0.300	2.5	150	150 <sup>W</sup>	.....	9.0	8000	4900	40	.....	.....	.....	
12CX6	T-5½	Pentode	7BK	12.6	0.150	2.75	200	82 <sup>W</sup>	125	15.0	3.4	150000	7000	.....	.....	.....	
12CY6	T-5½	Pentode	7BK	12.6	0.200	.....	12.6 2.2 Meg <sup>1</sup> 12.6 1.6 0.4 140000 3250										
12D4	T-9	Diode	4CG	12.6	0.600	5.5	Max. Inverse Peak Plate Voltage = 4400 Volts. Max. D.C. Plate Current = 155 Ma.										
12DB5	T-6½	Beam Pent.	9CH	12.6	0.600	11	Characteristics Same as Type 6DB5.										
12DE8	T-6½	Diode Pent.	12DE8	12.6	0.200	R-F or I-F Amplifier	.....	12.6	0.8 <sup>1</sup>	12.6	1.3	0.5	300000	1500	.....	.....	
12DF5	T-6½	Duodiode	9BS	12.6	0.450	F-W Rect.	.....	6.3	0.900	.....	.....	.....	.....	.....	.....	.....	
12DF7	T-6½	Duotriode	9A	12.6	0.150	1.1	Characteristics Same as Type 12AX7A/ECC83. (Special Low Noise.)										
12DK5	T-6½	Pentode	9GT	12.6	0.300	R-F Amp.	.....	12.6	2.2 Meg <sup>1</sup>	12.6	2.0	0.65	100000	3300	.....	.....	
12DK7	T-6½	Duodiode Tetrode	9HZ	12.6	0.500	Det. Power Amp. Driver	0.55	12.6	2.2 Meg <sup>1</sup>	12.6	6.0	1.0	4000	5000	.....	3500	
12DL8	T-6½	Duodiode Tetrode	9HR	12.6	0.550	Det. Power Amp. Driver	.....	12.6	G <sub>2</sub> = 2 G <sub>1</sub> = 12.6	8	75	480	15000	800	.....	40	
12DM4A	T-9	Diode	4CG	12.6	0.600	T.V. Damper	6.5	Characteristics Same as Type 6DA4A/6DM4A.									
12DM5	T-5½	Beam Pent.	7CV	12.6	0.450	Power Amp.	6.0	110	7.5	110	49.0	4.0	14000	7500	.....	2500	

Low Noise and Low Microphonism Version of Type 12AX7A/ECC83.																	
T-6½	Duotriode	9A	6.3 12.6	0.260 0.130	A-F Amp.	1.1	200	68	125	26	5.6	53000	10500	.....	.....		
T-6½	Pentode	9BF	12.6/ 6.3	0.300 0.600	Video Amp.	6.5	200	68	125	26	5.6	53000	10500	.....	.....		
T-6½	Duodiode Tetrode	9JU	12.6	0.400	Det. Power Driver	.....	12.6	2.2 Meg <sup>†</sup>	G1 = 12.6	35-15†	80	.....	.....	.....	700		
T-5½	Gated Beam	7EN	12.6	0.150	Quad FM Det.	1.7	Characteristics Same as Type 6DT6A.									.....	.....
T-6½	Duotriode	9A	6.3 12.6	0.300 0.150	A-F Amp.	1.1	Characteristics Same as Type 12AX7. Controlled for Hum and Noise.									.....	.....
T-6½	Duodiode Tetrode	9JX	12.6	0.280	Det. Power Amp. Driver	.....	12.6	2.2 Meg <sup>†</sup>	12.5	12	1.5	6000	6200	.....	2700		
T-6½	Duodiode Tri.	9JY	12.6	0.190	Det. Amp.	.....	12.6	2.2 Meg <sup>†</sup>	.....	0.4	.....	19000	750	14	.....		
T-6½	Duodiode Tetrode	9HR	12.6	0.375	Detector, Pwr. Amp. Dr.	.....	12.6	18 Ohm <sup>■</sup>	G1 = 12.6	6.8	54	900	8500	7.6	1250		
T-6½	Beam Pent.	90K	12.6	0.600	Vert. Defl. Amplifier	11	Max. Peak Positive Plate Voltage = 2200 Volts. Max. D.C. Cathode Current = 65 Ma.									.....	.....
T-6½	Duotriode	9A	6.3 12.6	0.300 0.150	Sect. 1 A-F Voltage Amp.	1.2	100	1.0	.....	0.5	.....	80000	1250	100	.....		
T-6½	Duodiode	9JC	12.6	0.450	Dissimilar Tri's Voltage Amp.	0.5	250	2.0	.....	1.2	.....	62500	1600	100	.....		
T-6½	Triode Tetrode	9JD	12.6	0.350	Relay Pwr. Amp. Dr.	.....	12.6	0	.....	1.9	.....	6500	3100	20	.....		
T-5½	Pentode	7BK	12.6	0.190	R-F Amp.	.....	12.6	2.2	12.6	14.0	2	10000	2000	20	.....		
T-6½	Tri. Beam Pentode	9EX	12	0.450	A-F Voltage Amp. and Power Amp.	7.15	.825 Characteristics Same as Type 6DZ8.									.....	.....
T-5½	Pentode	7BK	12.6	0.190	I-F Amp.	.....	12.6	G1 = 10 Meg <sup>†</sup>	12.6	3.2	1.4	32000	3800	.....	.....		
T-6½	Tri. Pentode	9FA	12.6	0.225	FM Osc. FM Amp.	.....	12.6	0	12.6	2.4	0.28	6000	4700	25	.....		
T-5½	Pentode	70V	12.6	0.450	S.T. A1 Amp.	6.25	110	4.0	110	32	4	14000	8100	.....	4500		
T-9	Beam Pent.	7S	12.6	0.450	Vert. Defl. Amplifier	11	Characteristics Same as Type 6EF6.									.....	.....
T-5½	Heptode	70H	12.6	0.150	Mixer Oscillator	.....	12.6	0.8†	12.6	0.4	2.47	15000	800	.....	.....		
T-5½	Duodiode Tri.	7FB	12.6	0.150	Det. Amp.	.....	12.6 Volts Grid No. 4 and 2.2 Megohms Grid No. 1 (Osc. Grid).									.....	.....
T-6½	Diode Tetrode	9HV	12.6	0.500	Det. Power Amp. Driver	0.55	12.6	1.0 Meg <sup>†</sup>	.....	.75	.....	45000	1200	55	.....		
T-9	Beam Pent.	7S	12.6	0.600	Vert. Defl. Amplifier	7.0	Max. Peak Positive Pulse Plate Voltage = 1200 Volts. Max. D.C. Cathode Currents = 50 Ma.									.....	.....
T-5½	Pentode	7BK	12.6	0.175	R-F or I-F Amplifier	.....	12.6	0.7	12.6	1.9	0.7	400000	2700	.....	.....		

TYPE	CONSTRUCTION		EMITTER		USE	Plate Diss. Watts	Plate Volts	Negative Grid Volts	Screen Volts	Plate Current Ma.	Screen Current Ma.	Screen Resis. Ohms	Transcon-ductance Micros.	Ampli-fication Factor	Ohms Load for Stated Power Output	Power Output Milli-watts	
	Bulb Size or Style	Class	Basing Diag.	Volts													Amps.
12FGT	T-9	Triode	5M	12.6	0.150	Amplifier	Characteristics Same as Type 6F5GT.										
12FA6	T-5½	Heptode	7CH	12.6	0.150	Converter	12.6	0.5	12.6	.45	1.0	800000	320*	.....	.....	.....	
12FB5	T-6½	Beam Pent.	9CV	12.6	0.300	S.T. A1 Amp.	12.6	2.2 Meg.†	180	31	7.3	.....	.....	.....	5000	2250	
12FK6	T-8½	Duodiode Tri.	7BT	12.6	0.150	Det. Amp.	12.6	2.2 Meg†	.....	1.3	.....	6200	1200	74	.....	.....	
12FM6	T-5½	Duodiode Tri.	7BT	12.6	0.150	Det. Amp.	12.6	2.2 Meg†	.....	1.0	.....	7700	1300	10	.....	.....	
12FQ8	T-6½	Twin, Double-Plate Triode	9KT	12.6	0.150	Sect. 1 Double Plate Triode Sect. 2 Double Plate Triode	0.5	250	1.5	.....	1.5	.....	76000	1250	95	.....	
12FR8	T-6½	Tri. Pentode Diode	9KU	12.6	0.320	Det. Amp. R-F Amp.	.....	12.6 2.2 Meg† 12.6 2.2 Meg†	.....	1.0 1.9	0.8	400000	2700	.....	.....	.....	
12FT6	T-5½	Duodiode Triode	7BT	12.6	0.150	Det. Power Amp. Driver	.....	12.6 2.2 Meg†	.....	0.6	.....	13000	1000	14	.....	.....	
12FV7	T-6½	Duotriode	9A	6.3/ 12.6	0.90/ 0.450	Relay Control Tube	2.5	100	2.0	.....	16	.....	2250	9600	.....	.....	
12FX5	T-5½	Pentode	7CV	12.6	0.450	Power Amp.	5.5	110	62 <sup>m</sup>	115	35	12	17500	13500	.....	3000	
12FX8A	T-6½	Tri. Heptode	9KV	12.6	0.270	R-F Amp. Converter	.....	12.6 2.2 Meg† 12.6 G3=2.2M†	12.6	1.3 0.29	1.25	.....	300*	.....	.....	1400 EC1 = 1.6 V (RMS) Rg1 = 33 K Ohms	
12G8	T-6½	Duotriode	9CZ	12.6	0.400	Amplifier	.....	12.6	0	Input Tri. Output Tri.	3.0 7.2	.....	8500	2600	22	2000	
12GA6	T-5½	Heptode	7CH	12.6	0.150	Converter	.....	12.6 G3=2.2 M† EC1 = 1.6 Volts (RMS), Rg1 = 33000 Ohms, IC1 = .06 Ma.	12.6	0.3	0.8	1.0 Meg.	140	.....	.....	.....	
12GB3	T-9	Beam Pent.	8GT	12.6	0.600	Horiz. Amp.	14	100	7.7	100	100	7	5300	14000	6.0	.....	
12GC6	T-12	Beam Pent.	8JX	12.6	0.600	Horiz. Defl. Amplifier	17.5	Characteristics Same as Type 6GC6.									
12QN6	T-5½	Pentode	7FW	12.6	0.150	R-F Amp.	3.3	Characteristics Same as Type 6QN6.									
12H6	Metal	Duodiode	7Q	12.6	0.150	Rectifier	.....	Characteristics Same as Type 6H6.									
12HL5	T-6½	Beam Pent.	9QW	12.6	0.450	Power Amp.	12.0	Characteristics Same as Type 6HL5.									
12L6GT	T-9	Triode	6Q	12.6	0.150	Amplifier	2.75	Characteristics Same as Type 6L5GT.									
12J7GT	T-9	Pentode	7R	12.6	0.150	R-F Amp.	.825	Characteristics Same as Type 6J7G.									
12J8	T-6½	Duodiode Tet. Beam Pent.	9GC	12.6	0.300	Det. Amp.	.....	12.6	2.2 Meg†	12.6	12	1.5	6000	5500	.....	2700	
12JQ6	T-6½	Diode	9RA	12.6	0.600	Vertical Defl. Amplifier	.....	Characteristics Same as Type 6JQ6.									
12K5	T-5½	Tetode	7EK	12.6	0.400	Power Amp. Driver	.....	12.6	G2=2	G1=12.6	8	75	480	15000	7.2	800	
12K7GT	T-9	Pentode	7R	12.6	0.150	R-F Amp.	3.0	Characteristics Same as Type 6K7G.									
12K8	Metal	Tri. Hexode	8K	12.6	0.150	Mixer Osc. Converter	3.0	Characteristics Same as Type 6K8GT.									



12KL8	T-6½	Diode Pent.	9LQ	12.6	0.150	Detector R-F I-F Amp.	3.0	Characteristics Same as Type 6KL8.								
12L6GT	T-9	Beam Pent.	7S	12.6	0.600	Power Amp.	11	Characteristics Same as Type 25L6GT								
12Q7GT	T-9	Duodiode Tri.	7V	12.6	0.150	Det. Amp.	0.55	Characteristics Same as Type 6Q7GT.								
12R6	T-5½	Beam Pent.	7CV	12.6	0.600	Vert. Defl. Amplifier	4.95 110 40.0	8.5	110	3.3	Max. D.C. Cathode Current = 45 Ma. 13000 7000					
12RK19/12BR3	T-6½	Diode	9CB	12.6	0.600	T.V. Damper	6.5	Characteristics Same as Type 6RK19/6BR3.								
12SC7	Metal	Duotriode	8S	12.6	0.150	A-F Amp.	3.85	Characteristics Same as Type 6SC7.								
12SF5GT	T-9	Triode	6AB	12.6	0.150	A-F Amp.	.....	Characteristics Same as Type 6SF7.								
12SF7	Metal	Diode Pent.	7AZ	12.6	0.150	Det. Amp.	3.85	Characteristics Same as Type 6SF7.								
12SG7	Metal	Pentode	8BK	12.6	0.150	R-F Amp.	3.3	Characteristics Same as Type 6SG7.								
12SH7	Metal	Pentode	8BK	12.6	0.150	R-F Amp.	3.3	Characteristics Same as Type 6SH7.								
12SJ7	Metal	Pentode	8N	12.6	0.150	A-F Amp.	2.75	Characteristics Same as Type 6SJ7GT.								
12SK7	Metal	Pentode	8N	12.6	0.150	R-F Amp.	4.4	Characteristics Same as Type 6SK7GT.								
12SR7	Metal	Duodiode Tri.	8Q	12.6	0.150	Det. Amp.	2.75	Characteristics Same as Type 6SR7.								
12U7	T-6½	Duotriode	9A	12.6	0.150	Class A1 Amp.	.....	12.6	0	.....	12500 1600 20					
13FR7	9-T9	Duotriode	9HF	13.0	0.450	Vert. Defl. Amp./Osc.	1.5	Characteristics Same as Type 6FR7.								
13V10	Comp. T-9	Double Pent.	12EZ	13.2	0.450	FM-Det. Audio Output	1.7 6.5	150 145	560 <sup>m</sup> 6	100 125	1.3 36	2.0 5.5	150000 58000 6400	1000 3000 1.5		
14A7	Lock-in	Pentode	8V	12.6	0.150	R-F Amp.	4.4	Characteristics Same as Type 7AZ.								
14AF7/XXD	Lock-in	Duotriode	8AC	12.6	0.150	Amplifier	2.75	Characteristics Same as Type 7AF7.								
14B6	Lock-in	Duodiode Tri.	8W	12.6	0.150	Det. Amp.	0.55	Characteristics Same as Type 7B6.								
14C5	Lock-in	Beam Pent.	6AA	12.6	0.225	Power Amp.	13.2	Characteristics Same as Type 7C5.								
14C7	Lock-in	Pentode	8V	12.6	0.150	R-F Amp.	1.1	100 250	1.0 3.0	100 100	5.7 2.2	1.8 0.7	400000 1.0 Meg. 1575	.....		
14F7	Lock-in	Duotriode	8AC	12.6	0.150	A-F Amp.	1.1	Characteristics Same as Type 7F7.								
14F8	Lock-in	Duotriode	8BW	12.6	0.150	Osc. Amp.	3.85	Characteristics Same as Type 7F8.								
14J08	T-6½	Duotriode Triode	9KR	14	0.150	FM Det./A-F Amp.	1.1	250	2.0	.....	2	.....	41000	2200	90	
14Q7	Lock-in	Heptode	8AL	12.6	0.150	Converter	1.1	Characteristics Same as Type 7Q7.								
14R7	Lock-in	Duodi. Pent.	8AE	12.6	0.150	Det. Amp.	2.2	Characteristics Same as Type 7R7.								
15AB9	T-6½	Twin Tetrode	10N	15.0	0.150	VHF Amp.	2.0	Characteristics Same as Type 6AB9.								
15DQ8	T-6½	Triode Pent.	9HX	15.0	0.300	Tri. Sync. Sep. Pent. Vid. Amp.	1.0 200 220	1.7 3.4	220 18	3.0 3.0	.....	.....	4000 150000 10000	65	.....	
15HA6	T-6½	Pentode	9NW	15.0	0.300	Video Amp.	8.0	Characteristics Same as Type 6HA6.								
16AK9	Comp. T-12	Double Triode Pent.	12GZ	16.4	0.600	Pen.-Ver. Defl. Amplifier Tri.#2 Ver. Osc. Tri.#1 Syn. Clip.	.....	Characteristics Same as Type 6AK9.								
16BX11	Comp. T-9	Double Triode Pent.	12CA	16.0	0.315	Pent. Vid. Amp. Tri. #1 Amp. Tri. #2 Amp.	3.0 125 200	2.0 150 150	56 <sup>m</sup> 220 <sup>m</sup>	125 .....	12.0 11.0	3.8 .....	100000 6800 8400	11300 6200 6800	42 57	.....
17AB9	T-6½	Twin Tetrode	10N	16.8	0.150	VHF Amp.	2.0	Characteristics Same as Type 6AB9.								
17BB14	T-9	Beam Pent.	9NH	16.8	0.450	Horiz. Amp.	13	100	7.7	100	100	7	5300	14000	6.0	.....



19C8	T-6½	Triple Dio. Tri.	9E	18.9	0.150	Det. Amp.	1.1	100	1.0	0.5	80000	1250	100		
19DE3	Comp.	T-9 Diode	12HX	19	0.600	Damper	.....	Max. Peak Inverse Plate Voltage = 5000 Volts. Max. Peak Plate Current = 1050 Ma. Max. Avg. Plate Current = 350 Ma.	.....	.....	.....	.....	.....		
19V8	T-6½	Triple Diode Triode	9AH	18.9	0.150	Det. Amp.	1.1	100	1.0	0.8	54000	1300	70		
								250	3.0	1.0	58000	1200	70		
21E4X6	T-12	Beam Pent.	5BT	21.5	0.600	Horiz. Defl. Amplifier	22	Characteristics Same as Type 6EX6.							
21HD5	Comp.	Beam Pent.	12ES	21.5	0.600	Horiz. Defl. Amp.	24	Characteristics Same as Type 6HD5.							
21LG6	Comp.	Beam Pent.	12HL	21.0	0.600	Horiz. Defl. Amplifier	.....	Characteristics Same as Type 6LG6.							
22JG6	Novar	Beam Pent.	9QU	22.0	0.450	Horiz. Defl. Amp.	17	Characteristics Same as Type 6JG6 and 6JG6A.							
22JR6	T-12	Beam Pent.	9QU	22.0	0.450	Horiz. Defl. Amplifier	.....	Characteristics Same as Type 6JR6.							
26AX4GT	T-9	Diode	4CG	25.0	0.300	T.V. Damper	5.28	P.I.V. = 4000 Volts Max. D.C. Plate Current = 125 Ma. Max.							
26BB14	T-9	Beam Pent.	9NH	25	0.300	Horiz. Amp.	13	100	7.7	100	100	7	3300	14000	6.0
26BK5	T-6½	Beam Pent.	9BQ	25.0	0.300	Power Amp.	9.9	Characteristics Same as Type 6BK5.							
26BR3	T-6½	Diode	9CB	25.0	0.300	T.V. Damper	6.5	Characteristics Same as Type 6BR3.							
26CA5	T-5½	Beam Pent.	7CV	25.0	0.300	Power Amp.	5.5	Characteristics Same as Type 6CA5.							
26DK4	T-5½	Diode	5BQ	25	0.150	H-W Rect.	.....	117 A.C. Volts, RMS, 90 Ma. D.C. Output. (Condenser Input to Filter.)							
26DN6	T-12	Beam Pent.	5BT	25.0	0.600	Horiz. Defl. Amplifier	16.5	Peak Positive Pulse Plate Voltage = 6600 Volts Max. D.C. Cathode Current = 200 Ma.							
26DQ6A	T-12	Beam Pent.	6AM	25	0.300	Horiz. Defl. Amplifier	16.5	Characteristics Same as Type 6DQ6A.							
28E5	T-9	Beam Pent.	8GT	25	0.300	Horiz. Defl. Amp.	....	100	8.2	100	100	7	5000	14000	5.6
28EC6	T-12	Beam Pent.	5BT	25.0	0.600	Horiz. Defl. Amp.	10.0	135	22.5	135	70	4.5	4700	7500	.....
28F5A	T-5½	Beam Pent.	7CV	25.0	0.150	Power Amp.	5.0	110	7.5	110	45.0	7.3	33000	6400	1500
28JQ6	T-6½	Beam Pent. Diode	9RA	25.2	0.300	Vert. Defl. Amplifier	.....	Characteristics Same as Type 6JQ6.							
28L6GT	T-9	Beam Pent.	7S	25.0	0.300	Power Amp. P-PA	11	110	7.5	110	49.0	4.0	13000	8000	2100
								200	180*	125	46	2.2	28000	8000	3800
28Z5	ST-12	Duodiode	6E	25.0	0.300	Doubler	.....	Characteristics Same as Type 25Z6GT.							
28Z6GT	T-9	Duodiode	7Q	25.0	0.300	H-W Rect.	.....	117 A.C. Volts Per Plate, RMS, 75 Ma. Output Current. 235 A.C. Volts, RMS, 75 Ma. Output Current Per Plate.							
28HU5	T-12	Beam Pent.	8NB	26	0.600	Horiz. Defl. Amp.	33	175	21	110	125	3.3	6000	14000	4.0
28D7	Lock-in	Duo. Beam Pentode	8BS	28.0	0.400	Amplifier (per section)	3.0	28	390*	28	9.0	0.7	4000	4000	80
28D7W (3)						P.P. A2 Total		28	3.5	28	12.5	1.0	4200	3400	100
28HA6	T-6½	Pentode	9NW	28.6	0.150	Video Amp.	8.0	28	0	28	64.0	4.0	.....	.....	1500*
28HD5	Comp.	Beam Pent.	12ES	28.0	0.450	Horiz. Defl. Amp.	24.0	Characteristics Same as Type 6HD5.							
30HD5	Comp.	Beam Pent.	12ES	30.0	0.450	Horiz. Defl. Amp.	24.0	Characteristics Same as Type 6HD5.							

TYPE	CONSTRUCTION		EMITTER		USE	Plate Diss. Watts <sup>2</sup>	Plates Volts	Negative Grid Volts	Screen Volts	Plate Current Ma.	Screen Current Ma.	Transcon-ductance Microns.	Ampli-fication Factor	Ohms Load for Stated Power Output	Power Output Milli-watts	
	Bulb Size or Style	Class	Beaming Diag.	Volts												Amps.
31AL10	Comp. T-9	Double Tri. Pentode	12HR	31.5	0.315	Pent.-Vert Defl. Amp. Sec. F2 er. Osc Sec. F1 Syn. Clip	7.0 1.0 1.25	8.0 120 190	110 46 5.5 5.4	3.3 1800 1500 11000	2000 Volts. Maximum D.C. Cathode Current = 70 Ma.	20 3950 3900	20 43	.....	.....	
32HQ7	Comp. T-12	Diode Pent.	12HT	32.6	0.315	Damper Diode Horiz. Defl. Amplifier	7.0 110	22.5 110	42	3300 Volts. Maximum D.C. Plate Current = 120 Ma. Maximum Peak Positive Plate Voltage = 4000 Volts. Maximum D.C. Cathode Current = 125 Ma.	2.4 8000 4500	3.2	.....	.....	.....	
34R3	T-6½	Diode	9CB	34	0.150	Damper	.....	.....	.....	.....	Max. Peak Heater Cathode Voltage = 4500 Volts (-Heater Negative). Max. Peak Cathode Plate Voltage = 4500 Volts (Cathode Positive).	.....	.....	.....	.....	.....
35A5	Lock-in	Beam Pent.	6AA	35.0	0.150	Power Amp.	9.35	110	110	40.0	3.0	14000	.....	2500	1500	
35B5	T-5½	Beam Pent.	7BZ	35.0	0.150	Power Amp.	4.95	110	7.5	110	40.0	3.0	.....	2500	1500	
35DZ8	T-6½	Tri. Beam Pentode	9EX	35	0.150	A-F Voltage Amp. and Power Amp.	.....	.....	.....	.....	.....	.....	.....	2500	1500	
35EH5	T-5½	Beam Pent.	7CV	35	0.150	A-F Pwr. Amp.	5.5	110	7.5	110	40.0	3.0	.....	2500	1500	
35GL6	T-5½	Beam Pent.	7FZ	35	0.150	S.T. A1 Amp.	5.5	110	7.5	110	45-47†	3-9†	.....	2500	1800	
35HB8	T-5½	Triode Beam Pent.	9ME	35	0.150	Voltage Amp. S.T. A1 Amp.	7.5 6.5	.....	.....	.....	.....	.....	.....	.....	.....	
35L6GT	T-9	Beam Pent.	7S	35.0	0.150	Power Amp.	9.35	110	7.5	110	40.0	3.0	.....	2500	1500	
35LR6	Comp. T-12	Beam Pent.	12FY	35.0	0.450	Horiz. Defl. Amplifier	.....	.....	.....	.....	.....	.....	.....	5000	3000	
35Y4	Lock-in	Diode	5AL	35.0	0.150	H-W Rect.	.....	.....	.....	.....	.....	.....	.....	.....	.....	
35Z3	Lock-in	Diode	4Z	35.0	0.150	H-W Rect.	.....	.....	.....	.....	.....	.....	.....	.....	.....	
38HK7	Comp. T-12	Diode Pent.	12FS	37.8	0.450	Horiz. Amp. Damper	10.0	130	22	130	60	2.8	.....	.....	.....	
40A1	T-9	Ballast	8ES	.....	.....	Horiz. Reg.	.....	.....	.....	.....	.....	.....	.....	.....	.....	
40B2	T-9	Ballast	8ES	.....	.....	Horiz. Reg.	.....	.....	.....	.....	.....	.....	.....	.....	.....	
40FR5	T-5½	Power Pent.	7CV	40	0.100	A-F Power Amplifier	5.2	110	7.5	110	32	3	.....	2800	1500	
41	ST-12	Power Pent.	6B	6.3	0.400	Power Amp.	9.35	115	180	115	34	7	.....	3200	1300	
42	ST-14	Power Pent.	6B	6.3.	0.700	Power Amp.	12.1	.....	.....	.....	.....	.....	.....	.....	.....	
43	ST-14	Power Pent.	6B	25.0	0.300	Power Amp.	5.83	.....	.....	.....	.....	.....	.....	.....	.....	
45	ST-14	Triode	4D	2.5†	1.500	Power Amp.	11	180	31.5	.....	31.0	.....	.....	1650	830	
45B5	T-6½	Pentode	9CV	45.0	0.100	Audio Output	14	170	12.5	170	70	3.5	.....	2700	1600	
50A1	T-6½	Ballast	9CM	.....	.....	Fil. Ballast	.....	.....	.....	.....	.....	.....	.....	4600	2000	

50A5	Lock-in	Beam Pent.	6AA	50.0	0.150	Power Amp.	11	110	7.5	110	49.0	4.0	13000	8000	2000	2100		
								200	8.0	110	50.0	1.5	28000	8000	4000	3800		
50AX6G	ST-14	Duodiode	7Q	50.0	0.300	F-W Rect.	...	Characteristics Same as Type GAX6G.									...	...
50BK5	T-6½	Beam Pent.	9BQ	50.0	0.150	Power Amp.	9.9	250	5.0	250	35	3.5	0.1 Meg.	8500	6500	3500		
50BM8	T-6½	Tri. Pentode	9EX	50	0.100	A-F Tri. Amp. Power Amp.	1.1 7.7	100 200	0 16	100 200	3.5 35	5 7	28000 15000 20000	2500 6000 6400	70	3600 5600 3500		
50EH5	T-5½	Beam Pent.	7CV	50	0.150	S.T. A1 Amp.	5.5	Characteristics Same as Type 6EH5.									...	2500
50FA5	T-5½	Beam Pent.	7CV	50	0.150	S.T. A1 Amp.	5.2	110	7.5	110	40	3	13000	5800	...	1500		
50FE5	T-6½	Beam Pent.	8KB	50	0.150	S.T. A1 Amp. P.P. AB1 Amp.	14.5	Characteristics Same as Type 6FE5.									...	...
50FK5	T-5½	Power Pent.	7CV	50	0.100	S.T. A1 Amp.	5.0	110	62	110	32	8.5	14000	12800	...	3000		
50FY8	T-6½	Tri. Beam Pentode	9EX	50	0.150	Tri. Volt. Amp. Pent. S.T. A1 A. Pent. P.P. A1 A.	1.0 1.25 125	125 120	1.5 62	...	2.5 70-86†	10-19†	17000 5000	2700 7500	46	2000 6000		
50HN5	T-6½	Beam Pent.	9QW	50.0	0.150	Audio Output	11	130	56	130	70	5	7500	17000	13	...		
50LG10	T-9	Beam Pent.	7S	50.0	0.150	Power Amp.	...	Characteristics Same as Type 25LG10.									...	...
50X6	Lock-in	Duodiode	7DX	50.0	0.150	H-W Rect. Doubler	...	235 Volts RMS Per Plate, 75 Ma. D.C. Output Per Plate. 117 Volts RMS Per Plate, 75 Ma. D.C. Output.									...	...
50Y6GT	T-9	Duodiode	7Q	50.0	0.150	F-W Rect.	...	Characteristics Same as Type 25Z6GT.									...	...
50Y7GT	T-9	Duodiode	8AN	46.0	0.150	Doubler H-W Rect.	...	117 A.C. Volts, RMS, 65 Ma. Output with Panel Lamp. 150 A.C. Volts, RMS, 65 Ma. Output Per Plate with Panel Lamp. 235 A.C. Volts, RMS, 65 Ma. Output Per Plate with Panel Lamp.									...	...
53HK7	Comp. T-12	Diode Pent.	12FS	53.2	0.315	Damper Horiz. Amplifier	...	Characteristics Same as Type 38HK7.									...	...
56R9	Comp. T-9	Tri. Pentode	12EN	14.0 42.0	0.150 0.150	A-F Amp. Power Amp.	1.0 6.5	100 120	1500 8.0	110	...	0.6 50.0	55500 10000	1800 7500	100	2500 2300		
60E3	T-5½	Diode	60E3	60	0.150	H-W Rect.	...	117 Volts, RMS, 110 Ma. D.C. Output. Condenser Input.									...	3000
60FX5	T-5½	Pentode	7CV	60	0.100	S.T. A1 Pwr. Amplifier	5.5	110	62	115	36-35	10-12	17500	13500	...	1300		
60HL5	T-6½	Beam Pent.	9QW	60.0	0.100	Power Amp.	12	Characteristics Same as Type 6HL5.									...	...
KT66	Curved Bulb	Beam Pent.	7S	6.3	1.270	S.T. A1 Amp. P.P. AB1 Amp.	...	250	15	250	85	6.3	22500	6300	...	2200		
75	ST-12	Duodiode Tri.	6G	6.3	0.300	Def. Amp.	...	450	250	415	105-125†	5-18†	...	...	...	8000†		
78	ST-12	Pentode	6F	6.3	0.300	R-F Amp.	3.0	90	3.0	90.0	5.4	1.3	300000	1275	...	...		
								180	3.0	75.0	4.0	1.0	1 Meg.	1100	...	...		
								250	3.0	100	7.0	1.7	800000	1450	...	...		
80	ST-14	Duodiode	4C	5.0	2.000	F-W Rect.	...	350 A.C. Volts Per Plate, RMS, 125 Ma. Output Current. 500 A.C. Volts Per Plate, RMS, 125 Ma. Output Current. 500 A.C. Volts Per Plate, RMS, 125 Ma. Output Current.									...	...
83	ST-16	Duodiode	4C	5.0	3.00	F-W Rect.	...	450 A.C. Volts Per Plate, RMS, 225 Ma. Output Current.									...	...
84/6Z4	ST-12	Duodiode	5D	6.3	0.500	F-W Rect.	...	325 A.C. Volts Per Plate, RMS, 60 Ma. Output Current.									...	...
KT88	ST-16	Beam Pent.	7S	6.3	1.800	P.P. AB1 Amp.	...	450	65	450	100-240†	(Plate and Grid No. 2 Current.)	Ultra-Linear Circuit	Condenser Input to Filter.	3800†	65000		
VR-90-105-150	Now Listed as OB3, OC3 and OD3.																	

TYPE	CONSTRUCTION			EMITTER		USE	Plate Diss. Watts?	Plate Volts	Negative Grid Volts	Screen Volts	Plate Current Ma.	Screen Current Ma.	Plate Rehs. Ohms.	Transcon- ductance Micros.	Ampli- fication Factor	Ohms Load for Stated Power Output	Power Output Milli- watts
	Bulb Size or Style	Class	Basing Diag.†	Volts	Amps.												
117L7/M7GT	T-9	Diode Beam Pentode	8A0	117	0.090	H-W Rect. Power Amp.	6.6	117 A.C. Volts, RMS, 75 Ma.	5.2	105	43	4.0	17000	5300	.....	4000	850
117Z3	T-5½	Diode	40B	117	0.045	H-W Rect.	.....	117 Volts Per Plate (RMS), 90 Ma. DC Output.	.....	.....	.....	.....	.....	.....	.....	.....	.....
117Z6GT	T-9	Duodiode	7Q	117	0.070	Voltage Dblr.	.....	117 A.C. Volts Per Plate, RMS, 60 Ma. Output Current.	.....	.....	.....	.....	.....	.....	.....	.....	.....
407A	T-6½	Duodiode	407A	40	0.050	Amplifier	1.35	190	240 <sup>■</sup>	.....	8.2	.....	6370	5500	.....	.....	.....
GB-407A (3)				20	0.100												
408A	T-5½	Pentode	7BD	20	0.050	Amplifier	1.7	120	200 <sup>■</sup>	120	7.0	2.2	34000	5000	.....	.....	.....
GB-408A (3)																	
417A	T-6½	Triode	9V	6.3	0.300	UHF R-F Amp.	4.0	Characteristics Same as Type 5842									
807	ST-16	Beam Pent.	5AW	6.3	0.900	P.P.AB1 Amp.	25	400	45	60-140†	.....	.....	.....	.....	.....	.....	.....
807W (3)	T-12					P.P.AB2 Amp.	400	400	25	300	60-140†	2.15†	.....	.....	.....	.....	.....
						P.P.AB2 Amp.	600	300	300	60-200†	0.7-1.6†	.....	.....	.....	.....	.....	.....
884	ST-12	Gas Triode	6Q	6.3	0.600	Relay Tube	.....	300	30	.....	75	.....	.....	.....	.....	.....	.....
FM1000	Lock-in	Heptode	FM 1000	6.3	0.300	F-M Det.	.....	.....	.....	.....	.....	.....	.....	.....	.....	.....	.....
1216 (3)	T-5½	Duodiode	7BF	6.3	0.300	Computer	0.55	100	470 <sup>■</sup>	.....	4.8	.....	7950	3400	.....	.....	.....
GB-1216 (3)								150	10	.....	4.8 Min.	.....	20K Ohms.	27	.....	.....	.....
								150	10	.....	0.1 Max.	.....	20K Ohms.	27	.....	.....	.....
1217 (3)	T-5½	Heptode	7CH	6.3	0.300	Dual-Control Computer	1.0	67.5	0	67.5	Grid No. 3 = 0 Volts	.....	.....	.....	.....	.....	.....
GB-1217 (3)								150	0	67.5	Grid No. 3 = 0 Volts	.....	.....	.....	.....	.....	.....
								150	0	75	5.8	.....	.....	.....	.....	.....	.....
1218A	T-5½	Triode	7DK	6.3	0.225	UHF Amp.	4	200	100 <sup>■</sup>	.....	18	.....	.....	10750	55	.....	.....
GB1220/565A(3)	T-5½	Pentode	7BD	6.3	0.175	VHF Amp.	1.65	120	2	120	7.5	2.5	300000	5000	.....	.....	.....
1221	ST-12	Pentode	6F	6.3	0.300	Amplifier	.825	Special Non-Microphonic Tube, Characteristics Same as Type 606.									
1222A	ST-14	Beam Pent.	1222	6.3	0.900	Power Amp.	20.9	Characteristics Similar to Type 6L6GA.									
1223	ST-12	Pentode	7R	6.3	0.300	Amplifier	.825	"G", Equivalent of Type 1221 Above.									
1229	ST-12	Tetode	4K	2.0†	0.060	.....	.....	Special Type 32. Made for Low Grid Current Application.									
1230	T-9	Triode	4D	2.0†	0.060	.....	.....	Special Type 30. Made for Low Grid Current Applications.									
1231	Lock-in	Pentode	8V	6.3	0.450	R-F Amp. Tel. Amp.	.....	300	200 <sup>■</sup>	150	10.0	2.5	700000	5500	.....	.....	.....
1232	.....	.....	.....	.....	.....	.....	.....	300	200 <sup>■</sup>	150	12.0	0.5	940000	6500	.....	.....	.....
1236A	T-9	Diode	1236A	1.9†	0.450	Regulator	.....	Plate Voltage = 330 Volts (Abs. Max.). D.C. Current = 0.8 Ma. (Abs. Max.). Plate Current = 0.63 Ma. Plate Load Resistance = 0.25 Meg.									
1238	Lock-in	Duo. Beam Amplifier	88S	28.0	0.400	Amplifier	3.3	Characteristics Similar to 28D7.									
1247	T-3	Diode	1247	0.7†	0.065	R-F Probe	.....	300 A.C. Volts RMS, 0.4 Ma. D.C. Plate Current.									
GB1252/6U8A(3)	T-6½	Tri. Pentode	9AE	6.3	0.450	VHF Osc. VHF Amp.	2.5	125	1	110	13.5	3.5	200000	7500	.....	.....	.....
1265	ST-12	Diode	4AJ	.....	.....	Voltage Reg.	.....	Starting Voltage = 135; Operating Voltage = 90; Operating Current = 5 to 30 Ma.									

1266	T-9	Diode	4AJ	.....	Regulator	.....	Voltage Regulator Similar to Type OB3/VR-90-30, Except Regulating at 70 Volts.	
1267	T-9	Gas Triode	No Jumper	.....	Relay Tube	.....	Similar to Type OA4G.	
1273	Lock-in	Pentode	8V	6.3	0.300	1.1	Characteristics Same as Type 7C7 (Special Non-Microphonic Tube).	
1274	T-9	Duodiode	6S	6.3	0.600	.....	Characteristics Same as Type 7Y4.	
1275	ST-16	Duodiode	4C	5.0 $\frac{1}{2}$	1.750	.....	Similar to Type 5Z3.	
1276	ST-16	Triode	4D	4.5 $\frac{1}{2}$	1.140	16.5	Similar to Type 6A3.	
1280	Lock-in	Pentode	8V	12.6	0.150	1.1	Characteristics Same as Type 14C7 (Special Non-Microphonic Tube).	
1284	Lock-in	Pentode	8V	12.6	0.150	R-F Amp.	..... 250 3 100 9.0 2.5 800000 200	
1291	Now Known as Type 3B7.							
1293	Lock-in	Triode	4AA	1.4 $\frac{1}{2}$	0.110	Oscillator	..... 90 0 ..... 5.2 1500 15 ..... 90 20 ..... 13.25 120 Mic. Oscillator Rg = 10000 Ohms.	
1294	Now Known as Type 1R4							
1299	Now Known as Type 3D6.							
1612	Metal	Heptode	7T	6.3	0.300	Mixer Amp.	1.65	Characteristics Same as Type 6L7.
1614	T-10 Sp.	Beam Pent.	7S	6.3	0.900	P.P.AB1 Amp.	21	360 22.5 270 88-132 $\frac{1}{2}$ 15 $\frac{1}{2}$ ..... 6600 26500 530 36 340 60-160 $\frac{1}{2}$ 20 $\frac{1}{2}$ ..... 7200 50000
1625	ST-16	Beam Pent.	5AZ	12.6	0.450	P.P.AB1 Amp. P.P.AB2 Amp.	25	Characteristics Same as Type 807.
2050A	ST-12	Gas Tetraode	6BS	6.3	0.600	Relay Tube	..... 400 5.0 0 100 For Relay Operation Limit Time to 30 Seconds. ..... 220 4.0 0 75 1 Amp. Peak Current, 8 Volts Tube Drop.	
5636 (3)	T-3	Pentode	8DC	6.3	0.150	Mixer	1.1	100 150 $\frac{1}{2}$ 100 3.6 3.20000 1280 $\frac{1}{2}$ ..... 1000
5639 (3)	T-3	Beam Pent.	8DL	6.3	0.450	Power Amp.	4.0	150 100 $\frac{1}{2}$ 100 21 4 50000 9000 ..... 1000
5641 (3)	T-3	Diode	6CJ	6.3	0.450	H-W Rect.	.....	117 A.C. Volts Per Plate, RMS, 48 Ma. D.C. Output. Condenser Input to Filter. 235 A.C. Volts Per Plate, RMS, 45 Ma. D.C. Output. Condenser Input to Filter.
5642 (3)	T-3	Diode	5642	1.25 $\frac{1}{2}$	0.200	H-W Rect.	.....	Pulse Type Rectifier for Television Service, 10000 Volts Peak Inverse.
5643 (3)	T-3	Gas Tetraode	8DD	6.3	0.15	Relay Tube	.....	150 5 A.C. 0 16 (Grid Bias Voltage 180°, Out of Phase with Anode Voltage.)
5644 (3)	T-3	Gas Diode	4CN	.....	.....	Voltage Reg.	.....	Starting Voltage at 130, Operating Voltage 95, Operating Current 5 to 25 Ma.
5647 (3)	T-1	Diode	5647	6.3	0.150	Detector	.....	117 Volts, RMS Plate, 9 Ma. D.C. Output.
5651	T-5 $\frac{1}{2}$	Gas Diode	5B0	.....	.....	Volt. Ref.	.....	Starting Voltage = 115 Volts Max. Operating Voltage = 92 Volts Max.
5651WA (3)								Operating Current = 3.5 Ma. Max.
5654/6AK5W(3)	T-5 $\frac{1}{2}$	Pentode	7BD	6.3	0.175	VHF Amp.	1.65	120 200 $\frac{1}{2}$ 120 7.5 2.5 340000 5000 ..... 35
5654/6AK5W/6096								
5670(3)	T-6 $\frac{1}{2}$	Duotriode	8CJ	6.3	0.350	VHF Amp.	1.35	150 240 $\frac{1}{2}$ ..... 8.2 ..... 6370 5500
5670(3)								
5670WA(3)								
5686	T-6 $\frac{1}{2}$	Beam Pent.	9G	6.3	0.350	Power Amp.	8.25	250 12.5 250 27 5.0 ..... 3100 9000 2700
5687 (3)	T-6 $\frac{1}{2}$	Duotriode	9H	6.3	0.900	Amplifier	4.2	250 12.5 ..... 12 5400 16 ..... 3000 5400
GB-5687 (3)				12.6	0.450		.....	180 7.0 ..... 23 2000 8500 17 ..... 44000 1600 70
5691	T-9	Duotriode	8BD	6.3	0.600	A-F Amp.	1.0	250 2 2.3 6600 2000 20 ..... 9100 2200
5692	T-9	Duotriode	8BD	6.3	0.600	A-F Amp.	1.75	250 9 ..... 6.5 ..... 9100 2200
5693	Metal	Pentode	8N	6.3	0.300	A-F Amp.	2.0	250 3 100 3.0 0.85 ..... 1650

TYPE	CONSTRUCTION		EMITTER		USE	Plate Diss. Watts	Plate Volts	Negative Grid Volts	Screen Volts	Plate Current Ma.	Screen Current Ma.	Plate Res. Ohms	Transcon- ductance Micros.	Ampli- fication Factor	Ohms Load for Stated Power Output	Power Output Milli- watts
	Bulb Size or Style	Class	Basing Diag. <sup>1</sup>	Volts												
5702 5702WA (3) 5702WB (3)	T-3	Pentode	5702	6.3	0.200	VHF Amp.	120	200 <sup>#</sup>	120	7.5	2.5	340000	5000	.....	.....	.....
5703 5703WA (3) 5703WB (3)	T-3	Triode	5703	6.3	0.200	VHF Osc.	3.3	120	220 <sup>#</sup>	.....	9.0	.....	5000	25	.....	.....
5704 (3)	T-2	Diode	5704	6.3	0.150	VHF Det.	3.3	150 Volts, RMS Plate, 9 Ma. D.C. Output Current.	.....	.....	.....	4650	5800	27	.....	.....
5718 (3)	T-3	Triode	8DK	6.3	0.150	UHF Amp.	3.3	100 150 <sup>#</sup> 150 180 <sup>#</sup>	.....	8.5 13.0	.....	4150	6500	27	.....	.....
5719 (3)	T-3	Triode	8DK	6.3	0.150	UHF Amp.	.....	150 680 <sup>#</sup>	.....	1.85	.....	30500	2300	70	.....	.....
5722 (3)	T-5½	Diode	5CB	4.9	1.600	Noise Diode	.....	200 For Noise Generator Services lb 35 Ma. Max.	.....	.....	.....	.....	.....	.....	.....	.....
5725 (3) GB-5725 (3) 5725/6AS6W(3)	T-5½	Pentode	7CM	6.3	0.175	Mixer	1.65	120 2	.....	5.2	3.5	3200	.....	.....	.....	.....
5726/6AL3W(3) 5726/6AL3W(3) 5726/6AL3W/6097(3)	T-5½	Duodiode	6BT	6.3	0.300	Rectifier	.....	117 Volts, RMS Plate, 9 Ma. D.C. Output Current Per Plate.	.....	.....	.....	.....	.....	.....	.....	.....
5744 5749/6BA6W(3) GB-5749	T-3	Triode	5744	6.3	0.200	A-F Amp.	.....	250 500 <sup>#</sup>	.....	4	.....	.....	4000	70	.....	.....
5750 (3) 5750/6BE6W(3) GB-5750 (3)	T-5½	Heptode	7CH	6.3	0.300	Converter	1.1	Characteristics Same as Type 6BE6.	.....	.....	.....	.....	.....	.....	.....	.....
5751 (3) 5751WA (3) GB-5751 (3)	T-6½	Duodiode	9A	6.3 12.6	0.350 0.175	A-F Amp.	0.8	Characteristics Same as Type 12AX7/ECC83.	.....	.....	.....	.....	.....	.....	.....	.....
5763	T-6½	Beam Pent.	9K	6.0	0.750	RF Amp.	13.5 12.0	350 300	37 250	250 50	48.5 6.2	.....	.....	.....	.....	10300 12000
5783	T-3	Gas Diode	5783	.....	.....	Voltage Reg.	.....	Starting Voltage at 115 Volts.	.....	.....	.....	.....	.....	.....	.....	.....
5784	T-3	Pentode	5784	6.3	0.200	Amplifier	1.87	120 2	.....	5.2	3.5	.....	3200	.....	.....	.....
5785	T-3	Diode	5785	1.25	0.015	H-W Rect.	.....	1235 Volts, RMS Plate, 100 µA D.C. Output Current.	.....	.....	.....	.....	.....	.....	.....	.....
5814 (3) GB-5814A (3) 5814WA (3)	T-6½	Duodiode	9A	6.3/ 12.6	0.350/ 0.175	Class A Amplifier	3.0	100 250	0 8.5	.....	.....	6250 7700	3100 2200	19.5 17.0	.....	.....
5823	T-5½	Gas Triode	4CK	.....	.....	Relay Tube	.....	Peak Cathode Ma. = 100 Max. D.C. Cathode Ma. = 25 Max. Starter Anode Volt Drop = 61 Volts. Anode Drop = 62 Volts.	.....	.....	.....	.....	.....	.....	.....	.....
5824 (3)	ST-14	Beam Pent.	7S	25.0	0.300	Power Amp.	13.7	135 22	135	61	2.5	15000	5000	.....	1700	4300
5840 (3)	T-3	Pentode	8DL	6.3	0.150	R-F Amp.	1.1	100 150 <sup>#</sup>	100	7.5	2.4	26000	5000	.....	.....	.....
5842 (3)	T-6½	Triode	9V	6.3	0.300	UHF R-F Amplifier	4.0	150 62 <sup>#</sup>	.....	26	.....	1800	24000	43	.....	.....



5844 (3)	T-5½	Duotriode	7BF	6.3	0.300	Computer	1.0	100	470 <sup>■</sup>	.....	4.8	.....	7550	3700	28	.....
5845	T-5½	Duodiode	5CA	5.0 <sup>■</sup>	0.435	Control Diode	.....	300max.	.....	.....	2.0max.	.....	.....	.....	.....	.....
5847A (3)	T-6½	Pentode	9X	6.3	0.300	RF Amp.	3.3	150	4000 <sup>■</sup>	150	1.1	0.3	.....	3000	.....	.....
									4000 <sup>■</sup>	150	4.4	1.2	.....	8500	.....	.....
5851	T-3	Pentode	6CL	1.25 <sup>†</sup> 2.50 <sup>†</sup>	0.110	R-F Amp.	1.65	125	7.5	125	5.5	0.9	175000	1600	.....	650
5871	T-9	Beam Pent.	7S	6.3	0.035	Power Amp.	.....	.....	.....	.....	.....	.....	.....	.....	.....	.....
5879	T-6½	Pentode	9AD	6.3	0.450	A-F Amp.	13.2	250	3	100	1.8	0.4	2000000	1000	.....	.....
									8	100	Triode Connected	.....	13700	1530	21	.....
5881	T-11	Beam Pent.	7S	6.3	0.900	Power Amp.	25.3	Characteristics Same as Type 6L6G.	.....	.....	.....	.....	.....	.....	.....	.....
5889	T-3	Pentode	5889	1.25 <sup>†</sup>	7.5 Ma	Amplifier	.....	12	2.0	.....	.005	.005	.....	.....	.....	.....
5896 (3)	T-3	Duodiode	8DJ	6.3	0.300	F-W Rect.	.....	150	Volts, RMS Per Plate, 18 Ma, D.C. Output Current.	.....	.....	.....	.....	.....	.....	.....
5899 (3)	T-3	Pentode	8DL	6.3	0.150	R-F Amp.	1.1	100	120 <sup>■</sup>	100	7.2	2.2	260000	4500	.....	.....
5902 (3)	T-3	Pentode	8DL	6.3	0.450	Power Amp.	4.0	110	270 <sup>■</sup>	110	30	2.2	15000	4200	.....	1000
5903 (3)	T-3	Duodiode	8DJ	26.5	0.075	UHF Det.	.....	.....	.....	.....	.....	.....	.....	.....	.....	.....
5904 (3)	T-3	Triode	8DK	26.5	0.045	UHF Osc./Amp.	.....	.....	.....	.....	.....	.....	.....	.....	.....	.....
									26.5	2.2 Meg <sup>†</sup>	.....	3.0	.....	4000	5000	20
5905 (3)	T-3	Pentode	8DL	26.5	0.045	UHF Amp.	.....	.....	.....	.....	.....	.....	.....	.....	.....	.....
5906 (3)	T-3	Pentode	8DL	26.5	0.045	UHF Amp.	1.1	100	150 <sup>■</sup>	100	7.5	2.4	260000	5000	.....	.....
5907 (3)	T-3	Pentode	8DL	26.5	0.045	UHF Amp.	.....	.....	.....	.....	.....	.....	.....	.....	.....	.....
5908 (3)	T-3	Pentode	8DC	26.5	0.045	UHF Amp.	.....	.....	.....	.....	.....	.....	.....	.....	.....	.....
5910 (3)	T-5½	Pentode	6AR	1.4 <sup>†</sup>	0.050	R-F Amp.	.....	.....	.....	.....	.....	.....	.....	.....	.....	.....
5915 (3)	T-5½	Dual Control Heptode	7CH	6.3	0.300	Computer	1.0	150	0	75	5.8	9.0	Grid No. 3 Voltage = 0	.....	.....	.....
5915A (3)									150	10.0	7.5	0	Grid No. 3 Voltage = 0	.....	.....	.....
5916 (3)	T-3	Pentode	8DC	26.5	0.045	Dual-Control Mixer	1.1	100	150 <sup>■</sup>	100	5.3	3.6	110000	3200	.....	.....
									.....	.....	.....	.....	.....	.....	.....	.....
5931 (3)	T-12	Duodiode	5T	5.0 <sup>†</sup>	3.000	F-W Rect.	.....	.....	.....	.....	.....	.....	.....	.....	.....	.....
5932 (3)	T-12	Beam Pent.	7S	6.3	0.900	Power Amp.	21	Characteristics Same as Type 6L6G.	.....	.....	.....	.....	.....	.....	.....	.....
5933 (3)	T-12	Beam Pent.	5AW	6.3	0.900	Power Amp.	25	Characteristics Same as Type 807W.	.....	.....	.....	.....	.....	.....	.....	.....
5933WA (3)									.....	.....	.....	.....	.....	.....	.....	.....
5933WJ (3)									.....	.....	.....	.....	.....	.....	.....	.....
5953 (3)	T-6½	Duotriode	9A	6.3	0.300	Computer	2.5	67.5	0	.....	8.5	.....	6600	3200	21	.....
5953 (3)									150	0	5.4	.....	(Rb = 20000 Ohms)	.....	.....	.....
5953WJ (3)									.....	.....	.....	.....	.....	.....	.....	.....
5953 (3)	T-5½	Duotriode	7BF	6.3	0.450	Computer	1.5	100	50 <sup>■</sup>	.....	9.5	.....	6500	6000	39	.....
5953 (3)									150	0	5.0	.....	(Rb = 20000 Ohms)	.....	.....	.....
5954 (3)	T-6½	Duotriode	9A	6.3/ 12.6	0.450/ 0.225	Computer	2.4	150	220 <sup>■</sup>	.....	8.5	.....	7000	6700	47	.....
5955A (3)	T-3	Duotriode	8DQ	1.25 <sup>†</sup>	0.120	VHF Mixer	.....	.....	.....	.....	0.7	.....	1300	50	.....	.....
5958	T-3	Duotriode	8DR	1.25 <sup>†</sup>	0.200	VHF Amp. or VHF Osc.	0.96	135	3.0	45	6.0	0.6	.....	1700	.....	.....
5959	T-3	Duo. Pentode	8DS	1.25 <sup>†</sup>	0.160	VHF Amp.	.....	.....	.....	.....	.....	.....	.....	.....	.....	.....
5970	T-3	Triode	8DK	6.3	0.150	Amplifier	3.3	100	270 <sup>■</sup>	.....	10.0	.....	3650	4500	16	.....

TYPE	CONSTRUCTION			EMITTER		USE	Plate Diss. Watts	Plate Volts	Negative Grid Volts	Screen Volts	Plate Current Ma.	Screen Current Ma.	Plate Resis. Ohms	Transcon-ductance Micros.	Ampli-fication Factor	Ohms Load for Power Output	Power Output Milli-watts
	Bulb Size or Style	Class	Basing Diag. I	Amps.													
				Volts	Amps.												
5987 (3)	T-3	Triode	8DM	6.3	0.450	Amplifier	4.0	100	18	.....	9.0	.....	1850	.....	4.1	.....	.....
5998A	T-12	Duotriode	8BD	6.3	2.400	Passing Tube for V.R. Serv.	15	110	105	.....	100	.....	350	15500	5.4	.....	.....
6000	T-11	Beam Pent.	6CK	26.5	0.280	Class "C" Amp./Osc.	25	400	60	200	125	16	RG = 12000 Ohms, PK R-F = 75 V, IG1 = 5 Ma, Driving Power = 0.4 Watt, RG = 20K Ohms, PK, R-F = 75 V, IG1 = 3 Ma., Driving Pwr. = 0.23 Watts	.....	.....	.....	28
6005 (3)	T-5½	Beam Pent.	7BZ	6.3	0.450	S.T. Class A1	11	180	8.5	180	29	3.0	58000	3700	.....	5500	2000
GB-6005 (3)	T-5½	Beam Pent.	6005/6A05W/6095(3)	6.3	0.450	S.T. Class A1	.....	250	12.5	250	45	4.3	52000	4100	.....	5000	4500
6005/6A05W (3)	T-5½	Beam Pent.	6005/6A05W (3)	6.3	0.450	P.P. Class AB1	.....	250	15	250	70-79†	9-13†	.....	.....	.....	10000†	10000
6021 (3)	T-3	Duotriode	8DG	6.3	0.300	UHF Amp.	1.1	100	150	.....	6.5	.....	6480	5400	35	.....	.....
6028	T-5½	Pentode	7BD	20	0.050	Amplifier	1.87	120	180	120	7.5	2.5	300000	5000	.....	.....	.....
6080	T-12	Duotriode	8BD	6.3	2.500	Passing Tube for V.R. Service	13	135	250	.....	200	.....	280	7000	2	.....	.....
GB-6080	T-12	Duo Power Triode	8BD	26.5	0.600	Power Amp.	13	135	250	.....	125	.....	280	7000	2	.....	.....
6082A	T-12	Duo Power Triode	8BD	26.5	0.600	Power Amp.	13	135	250	.....	125	.....	280	7000	2	.....	.....
6095 (3)	T-5½	Beam Pent.	7BZ	6.3	0.450	Power Amp.	13.2	.....	.....	.....	.....	.....	.....	.....	.....	.....	.....
6096 (3)	T-5½	Beam Pent.	7BD	6.3	0.450	Power Amp.	13.2	.....	.....	.....	.....	.....	.....	.....	.....	.....	.....
6097	T-5½	Duotriode	6BT	6.3	0.300	F-W Rect.	.....	.....	.....	.....	.....	.....	.....	.....	.....	.....	.....
6098 (3)	T-12	Beam Tet.	6098	6.3	1.200	Oscilloscope Defl. Amp.	21.0	.....	.....	.....	.....	.....	.....	.....	.....	.....	.....
6099 (3)	T-5½	Duotriode	7BF	6.3	0.450	VHF Osc.	1.6	.....	.....	.....	.....	.....	.....	.....	.....	.....	.....
6100 (3)	T-5½	Triode	6BG	6.3	0.150	R-F Amp.	5.5	.....	.....	.....	.....	.....	.....	.....	.....	.....	.....
6101 (3)	T-5½	Duotriode	7BF	6.3	0.450	VHF Osc./ Amp.	1.6	.....	.....	.....	.....	.....	.....	.....	.....	.....	.....
GB-6101	T-5½	Duotriode	7BF	6.3	0.450	VHF Osc./ Amp.	1.6	.....	.....	.....	.....	.....	.....	.....	.....	.....	.....
6110 (3)	T-3	Duotriode	8DJ	6.3	0.150	UHF Det.	.....	.....	.....	.....	.....	.....	.....	.....	.....	.....	.....
6111 (3)	T-3	Duotriode	8DG	6.3	0.300	Med. Mu Amplifier	1.1	100	220	.....	8.5	.....	4200	4750	20	.....	.....
6112 (3)	T-3	Duotriode	8DG	6.3	0.300	High Mu Amplifier	0.55	100	1500	.....	0.8	.....	38900	1800	70	.....	.....
6118 (3)	Metal	Duotriode Tri.	7V	6.3	0.300	Det. Amp.	.....	100	1.0	.....	0.8	.....	58000	1200	70	.....	.....
6135 (3)	T-5½	Triode	6BG	6.3	0.170	VHF Osc./ Amp.	3.8	.....	.....	.....	1.0	.....	58000	1200	70	.....	.....
GB-6135 (3)	T-5½	Pentode	7BK	6.3	0.300	VHF Osc.	3.1	250	68	150	10.6	4.3	1 Meg.	5200	.....	.....	.....
6145	Lock-in	Pentode	8V	6.3	0.600	Computer	11	150	0	100	34	8.0	0.1 Meg.	9700	.....	.....	.....
GB-6145 (3)	Lock-in	Pentode	8V	6.3	0.600	Computer	11	150	0	100	34	8.0	0.1 Meg.	9700	.....	.....	.....

6147	T-3	Power Pent.	6CL	1.25 $\frac{1}{2}$	0.125	VHF Power Amplifier	1.5	125	7.5	125	5.5	0.9	175000	1600	.....		
6159B	T-12	Beam Pent.	7CK	26.5	0.300	Power Amp.	.....	Characteristics Same as Typ3 6146B/8298A.								.....	
6186 (3)	T-5 $\frac{1}{2}$	Pentode	7BD	6.3	0.300	VHF Amp.	2.5	250	200 $\frac{1}{2}$	150	7	2	.....	5000	.....		
6186/6AG5WA(3)																	
6187	T-5 $\frac{1}{2}$	Pentode	6187	6.3	0.175	VHF Amp.	1.6	120	2.0	120	5.2	3.5	.....	3200	.....		
6188	T-9	Duotriode	8BD	6.3	0.300	D.C. Amp.	1.1	250	2.0	.....	2.3	.....	44000	1600	70		
6189 (3)	T-6 $\frac{1}{2}$	Duotriode	9A	6.3	0.300	Osc./Amp.	3.0	Characteristics Same as Type 12AU7.								.....	
6189/12AU7WA(3)																	
6189 (3)	T-6 $\frac{1}{2}$	Beam Pent.	9BV	6.3	0.650	Computer Applications	7.5	250	3	150	30	7	90000	11000	22		
6201 (3)	T-6 $\frac{1}{2}$	Duotriode	9A	6.3	0.300	VHF Amp.	2.5	Characteristics Same as Type 12AT7.								.....	
6205 (3)	T-3	Pentode	8DC	6.3	0.150	UHF Amp.	1.1	100	150 $\frac{1}{2}$	100	7.5	2.4	0.26 Meg.	5000	.....		
6206 (3)	T-3	Pentode	8DC	6.3	0.150	UHF Amp.	1.1	100	120 $\frac{1}{2}$	100	7.5	2.0	0.26 Meg.	4500	.....		
6211A	T-6 $\frac{1}{2}$	Duotriode	9A	12.6/6.3	0.150/0.300	Computer	1.3	100	2.0	.....	6.6	.....	6500	4700	31		
6216	T-6 $\frac{1}{2}$	Beam Pent.	9CE	6.3	1.200	Voltage Reg.	10.0	100	3	100	72	3	18500	12500	.....		
6267	T-6 $\frac{1}{2}$	Pentode	9CQ	6.3	0.200	A-F Amp.	1.1	250	2.0	140	3.0	0.6	2.5 Meg.	1800	.....		
6308 (3)	T-3	Gas Diode	8EX	.....	.....	Voltage Reg.	.....	Starting Voltage at 115 Volts. Operating Voltage at 87 Volts and Current at 3.5 Ma. Max.								.....	
6336A	TT-16	Duo Power Triode	8BD	6.3	5.000	Passing Tube for V.R. Serv.	30	190	200 $\frac{1}{2}$	.....	182	300	13500	.....	2.7		
6350 (3)	T-6 $\frac{1}{2}$	Duotriode	9CZ	6.3	0.600	Computer	3.85	150	5.0	.....	11.0	.....	3900	4600	18		
6350 (3)																	
6352 (3)	T-3	Duotriode	8EY	3.0 $\frac{1}{2}$	Series	Regulator	.....	Temperature Limited Diode. Max. Ef. = 4.0. Max. Eb. = 275. Max. Ib. = 1.1 Ma.								.....	
6354	T-5 $\frac{1}{2}$	Diode	7DU	.....	.....	Voltage Reg.	.....	Starting Voltage at 180. Operating Volts 150. Operating Current 5 Ma. Min., 30 Ma. Max.								.....	
6394A	TT-16	Duo Power Triode	8BD	26.5	1.300	Passing Tube for V.R. Serv.	30	Characteristics Same as Type 6336A.								.....	
6418	T-2	Pentode	6418	1.25 $\frac{1}{2}$	0.010	Power Amp.	.....	22.5	1.2	22.5	.24	.60	420000	300	.....	100000	2200
6463	T-6 $\frac{1}{2}$	Duotriode	9CZ	6.3	0.600	Computer	4.4	200	11.0	.....	1.0	.....	3850	5200	20		
6483	T-3	Gas Tetrode	6483	.....	.....	Switching	.....	450	Trigger Grid Voltage = 0 Volts. Trigger Pulse Voltage = 300 Volts. Keep Alive Current = 4 $\frac{1}{2}$ $\mu$ A.								.....
6486A	T-6 $\frac{1}{2}$	Pentode	9DV	6.3	0.250	Dual Control Pentode	2.0	120	2	120	3.5	3.3	.....	3250	.....	.....	
6516	T-9 $\frac{1}{2}$	Beam Pent.	6CH	6.3	0.200	VHF/AF Power Amp.	5.2	250	13.5	250	16.0	2.25	150000	2550	.....	16000	1400
6520	T-16	Duo Power Triode	8BD	6.3	2.500	Passing Tube for V.R. Serv.	15.4	Characteristics Same as Type 6AS7G.								.....	
6528	ST-16	Duo Power Triode	8BD	6.3	5.000	Passing Tube for V.R. Serv.	30	100	4	.....	185	.....	245	37000	9	.....	
6550	ST-16	Beam Pent.	7AC	6.3	1.800	S.T. AT Amp. P.P.ABT Amp.	42.0	400	23	270	170-225 $\frac{1}{2}$	9-35 $\frac{1}{2}$	15000	11000	3500	60000	5000
6582A	T-6 $\frac{1}{2}$	Pentode	9EJ	6.3	0.250	R-F Pent.	2.0	120	2	120	7.5	2.5	.....	4500	.....	.....	

TYPE	CONSTRUCTION			EMITTER		USE	Plate Diss. Watts <sup>2</sup>	Plate Volts	Negative Grid Volts	Screen Volts	Plate Current Ma.	Screen Current Ma.	Plate Res. Ohms	Transcon- dience Micros.	Ampli- fication Factor	Ohms Load for Stated Power Output	Power Output Milli- watts
	Bulb Size or Style	Class	Basing Diag. <sup>1</sup>	Volts	Amps.												
6611	T-2x3	Pentode	6611	1.25 <sup>W</sup>	0.020	VHF Amp.	0.1	45	5 Meg. <sup>4</sup>	30	1.0	0.35	400000	1000	.....	.....	.....
6612	T-2x3	Pentode	6612	1.25 <sup>W</sup>	0.080	VHF Amp.	0.2	30	2 Meg. <sup>4</sup>	30	3.0	1.0	180000	3000	.....	.....	.....
6626	T-5½	Gas Diode	5B0	.....	.....	Voltage Reg.	.....	Starting Voltage = 165.	Operating Voltage = 148.	Operating Current = 5 to 30 Ma.	.....	.....	.....	.....	.....	.....	.....
6627	T-5½	Gas Diode	5B0	.....	.....	Voltage Reg.	.....	Starting Voltage = 130.	Operating Voltage = 108.	Operating Current = 5 to 30 Ma.	.....	.....	.....	.....	.....	.....	.....
6660/6BA6	T-5½	Pentode	7BK	6.3	0.300	R-F/I-F Amp.	3.3	100	68 <sup>W</sup>	100	10.8	4.4	250000	4300	.....	.....	.....
6661/6BH6	T-5½	Pentode	7CM	6.3	0.150	R-F/I-F Amp.	3.3	100	200 <sup>W</sup>	100	3.6	1.4	700000	3400	.....	.....	.....
6662/6BJ6	T-5½	Pentode	7CM	6.3	0.150	R-F/I-F Amp.	3.3	100	80 <sup>W</sup>	100	9.2	3.5	250000	3650	.....	.....	.....
6663/6AL5	T-5½	Duodiode	6BT	6.3	0.300	Detector	.....	A.C. Voltage Per Plate = 117 Volts.	D.C. Output Current = 9.0 Ma.	.....	.....	.....	.....	.....	.....	.....	.....
6664/6AB4	T-5½	Triode	50E	6.3	0.150	V-F Amp./ Osc.	2.9	Characteristics Same as Type 6AB4.	.....	.....	.....	.....	.....	.....	.....	.....	.....
6669/6AQ5	T-5½	Beam Pent.	7BZ	6.3	0.450	A-F Pwr. Amp.	12	250	12.5	250	45	4.5	52000	4100	.....	5000	4500
6676/6CB6A	T-5½	Pentode	7CM	6.3	0.300	VHF Amp.	2.3	Characteristics Same as Type 6CB6.	.....	.....	.....	.....	.....	.....	.....	.....	.....
6677/6CL6	T-6½	Beam Pent.	9BV	6.3	0.650	R-F Osc./ Amp.	8.5	250	3.0	150	30	7	150000	11000	.....	7500	2800
6678/6UBA	T-6½	Tri. Pentode	9AE	6.3	0.450	VHF Osc./ Amp.	3.0	150	56 <sup>W</sup>	110	18	3.5	5000	8500	40	.....	.....
6679/12A17	T-6½	Duotriode	9A	6.3/ 12.6	0.300/ 0.150	VHF Osc./ Amp.	2.8	100	270 <sup>W</sup>	.....	3.7	.....	15000	4000	60	.....	.....
6680/12A07A	T-6½	Duotriode	9A	12.6	0.150	Gen. Purpose	3.0	100	0	.....	11.8	.....	6500	3100	20	.....	.....
6681/12AX7	T-6½	Duotriode	9A	6.3/ 12.6	0.300/ 0.150	A-F Amp.	1.1	100	1.0	.....	10.5	.....	7700	2200	17	.....	.....
6690 (3)	T-3	Duotriode	8GQ	6.3	0.300	Video Amp.	1.1	100	100 <sup>W</sup>	.....	8.0	.....	8000	1250	100	.....	.....
6788 (3)	T-3	Pentode	8DL	6.3	0.175	Audio Amp.	0.5	100	1500 <sup>W</sup>	100	0.7	0.1	1.2 Meg.	1100	.....	.....	.....
GB-6814 (3)	T-3	Triode	8DK	6.3	0.150	Computer	2.2	100	0	.....	10	.....	4800	6000	29	.....	.....
6832	T-3	Duotriode	8DG	6.3	0.400	D.C. Amp.	0.1	100	3000 <sup>W</sup>	.....	0.8	.....	1050	.....	.....	.....	.....
6840	T-6½	Duotriode	9CZ	12.6	0.400	Computer	4.0	250	620 <sup>W</sup>	.....	14	.....	3400	7100	20	.....	.....
6851 (3)	T-6½	Duotriode	9A	6.3	0.250	Amplifier	1.0	250	3100 <sup>W</sup>	.....	1.0	.....	6000	1200	70	.....	.....
6854	T-6½	Duotriode	9FV	6.3	0.500	Amplifier	1.65	150	240 <sup>W</sup>	.....	8.2	.....	6500	5225	35	.....	.....
6870	T-6½	Beam Pent.	9BF	12.6	0.600	VHF Power Amplifier	6.9	250	120 <sup>W</sup>	250	25.0	3.5	230	8500	.....	.....	.....
6872	T-3	Pentode	6872	6.3	0.200	VHF Amp.	1.1	120	200 <sup>W</sup>	120	7.75	2.7	340000	.....	.....	4100	.....
6877	T-6½	Power Triode	9GB	6.3	0.800	Power Amp.	.....	150	12	.....	75	.....	2000	6500	.....	3.75	12000

6883 (3)	T-12	Beam Pent.	7CK	12.6	0.625	Power Amp.	20	Characteristics Same as Type 6146.									
6893	T-9	Beam Pent.	7CK	12.6	0.400	Power Amp.	10	Characteristics Same as Type 2E26.									
6900	T-6½	Duotriode	9H	6.3	1.000	Pulse Amp.	4.25	120	2	36	1700	11500	18.5	Maximum Peak Plate Current = 30 Ma.			
6919	T-6½	Duotriode	6BT	6.3	0.200	F-W Rect. Computer	.....	Maximum Inverse Peak Plate Voltage = 300 Volts. Maximum Peak Plate Current = 30 Ma. Maximum D.C. Output Current = 10 Ma. (Design Max. Values.)			.....	.....	.....	.....			
6922	T-6½	Duotriode	9AJ	6.3	0.300	VHF Amp.	1.65	90	120	12	2800	11500	33	.....			
6939	T-6½	Duotetrode	9HL	6.3	0.600	P.P.-A1 Amp.	3.0	150	3.5	150	27-31.6	3.6-12.2	.....	7000	10560	1750	
				12.6	0.300	P.P.-A1 Amp.	.....	200	3.5	150	28-31.6	6-15.4	.....	7500	17400	2660	
6943 (3)	T-3	Pentode	8DC	6.3	0.175	R-F Amp.	1.0	100	150	100	8	2.3	300000	3600	.....	.....	
6944 (3)	T-3	Pentode	8DC	6.3	0.175	R-F Amp.	1.0	100	170	100	7	2.1	280000	3200	.....	.....	
6945 (3)	T-3	Beam Pent.	8DL	6.3	0.350	Power Amp.	3.0	100	270	100	25	1.5	20000	3500	.....	3000	
6946 (3)	T-3	Triode	8DK	6.3	0.175	Amplifier	1.5	100	270	.....	9.0	.....	3800	16.5	.....	.....	
6947 (3)	T-3	Duotriode	8DG	6.3	0.350	Amplifier	0.75	150	270	.....	6.5	.....	4000	35	.....	.....	
6948 (3)	T-3	Duotriode	8DG	6.3	0.350	Amplifier	0.50	100	1500	.....	0.8	.....	1650	70	.....	.....	
6954	T-5½	Pentode	7CM	6.3	0.300	Dual-Control Computer	3.3	150	1.0	150	5.8	6.6	50000	2050	Grid No. 3 = -3.0 Volts.	.....	
6955	T-6½	Duotriode	9A	6.3	0.350	Amplifier	3.0	100	0	.....	13.0	.....	5800	3500	21.3	.....	
				12.6	0.175	VHF Amp.	.....	250	8.5	.....	11.5	.....	7000	2350	16.5	.....	
6968	T-5½	Pentode	7BD	6.3	0.175	VHF Amp.	1.81	Characteristics Same as Type 6AK5.			.....	.....	.....	.....	.....	.....	
6977	T-1	Triode	6977	1.0	0.030	Indicator	.....	50	0-3	.....	.....	.....	.....	.....	.....	.....	
7001	T-5½	Beam Tetrode	7EJ	6.3	0.450	Power Amp.	5.5	120	250	120	35	4	.....	4800	.....	.....	
7025A	T-6½	Duotriode	9A	12.6	0.150	Audio Amp.	1.1	Characteristics Same as Type 12AX7/ECC83 except Controlled for Noise and Hum.			.....	.....	.....	.....	.....	.....	
				6.3	0.300	.....	.....	.....	.....	.....	.....	.....	.....	.....	.....	.....	
7027A	T-12	Beam Pent.	8HY	6.3	0.900	P.P.-A1 Amp.	27.5	330	24	330	122-184	5.6-18.5†	.....	.....	.....	4500†	31500
								400	25	300	102-152†	6-17†	.....	.....	.....	6600†	34000
								450	30	350	95-194†	3.4-19.2†	.....	.....	.....	6000†	50000
								400	200	300	112-128†	7-16†	.....	.....	.....	6600†	32000
								380	180	380	138-170†	5.5-20†	.....	.....	.....	4500†	35000
								410	220	410	134-185†	(Cathode Current) Ultra-Linear Circuit.	.....	.....	.....	8000†	24000
7032	T-6½	Heptode	7CH	6.3	0.300	Computer	1.1	150	G1+3=0	75	3.5	6.0	G3+1=470K	1400	G1 = Control Grid	.....	
								150	G1+3=0	75	3.5	6.0	G3+1=470K	650	G3 = Control Grid	.....	
								150	6.0	75	<0.1	<0.1	8.8	G3+1=470K	G3 = 0 Volts	.....	
								150	0	75	<0.1	<0.1	8.8	G3+1=470K	G3 = -6 Volts	.....	
7036	T-6½	Heptode	7CH	6.3	0.300	Dual Control Computer	0.9	Characteristics Same as Type 5919A.			.....	.....	.....	.....	.....	.....	
				12.6	0.450	Computer	4.5	120	2.0	.....	36	.....	1750	12000	21	.....	
7044 GB-7044 (3)	T-6½	Duotriode	9H	6.3	0.300	Computer	.....	.....	.....	.....	.....	.....	.....	.....	.....	.....	
7054	T-6½	Power Pent.	7054	13.5	0.275	S.T.-A1 Amp. Class "C" Amplifier	5.0	250	120	150	19	3-5	100000	11500	Peak R-F (Ec1)=16 Volts, IC2=1 Ma. Driving Power = 15 MW.	4000	
7055	T-5½	Duotriode	6BT	13.5	0.155	Detector	.....	117	A.C. Volts Per Plate, RMS, 9 Ma. Output Current. 300 Ohms Min. Effective Plate Supply Imp.	.....	.....	.....	.....	.....	.....	.....	
7056	T-5½	Pentode	7CM	13.5	0.150	VHF Amp.	2.0	200	180	150	9.5	2.8	600000	6200	.....	.....	
7057	T-6½	Duotriode	9AJ	13.5	0.180	VHF Amp.	2.2	150	220	.....	10	.....	5300	6800	36	.....	
7058	T-6½	Duotriode	9A	13.5	0.155	A-F Amp.	1.0	250	2	.....	1.25	.....	61000	1650	100	.....	

TYPE	CONSTRUCTION		EMITTER		USE	Plate Diss. Watts:	Plate Volts	Negative Grid Volts	Screen Volts	Plate Current Ma.	Screen Current Ma.	Plate Reels. Ohms	Transconductance Micros.	Amplification Factor	Ohms Load for Output	Power Output Milli-watts					
	Bulb Size or Style	Class	Basing Diag.	Amps.																	
				Volts																	
7059	T-6½	Tri. Pentode	9AE	13.5	0.195	VHF Osc.	2.5	150	56	18	110	4700	8500	40	.....	.....					
						VHF Amp.	2.8	250	68	10	3.5	400000	5200	.....	.....	.....					
7060	T-6½	Tri. Pentode	9DX	13.5	0.280	VHF Osc.	2.5	150	150	9	.....	8200	4900	40	.....	.....					
						VHF Amp.	3.0	200	82	15	3.4	150000	7000	.....	.....	.....					
7061	T-6½	Beam Pent.	9EU	13.5	0.210	S.T.A1 Amp.	9.0	200	10	200	35.5	6000	4200	.....	5000	3000					
7077	Ceramic and Metal	Triode	7077	6.3	0.240	UHF R-F Amplifier	1.0	250	82	6.4	.....	8900	9000	80	.....	.....					
7105	T-12	Duo Power Triode	8BD	12.6	1.250	Passing Tube for V.R. Serv.	13.2	Characteristics Same as Type 6080WA.													
7119	T-6½	Duotriode	9H	6.3	0.640	Computer	4.5	120	2.0	2.0	.....	.....	15000	24	.....	.....					
							12.6	150	14	0.2	.....	.....	.....	.....	.....	.....					
7137 GB-7137 (3)	T-5½	Triode	7BQ	6.3	0.225	VHF Amp.	2.25	150	100	13.5	.....	.....	8500	40	.....	.....					
7150	Spec. Base T-9	Tetrode	9UH	6.3	0.450	VHF Amp.	4.0	135	GI = +8V RK = 250 Ohms	27.5	8.5	30000	35800	.....	.....	.....					
7167	T-5½	Tetrode	7EW	13.5	0.090	VHF Amp.	2.0	250	1.0	80	1.4	125000	8000	.....	.....	.....					
								Similar to Type 6CY5, Except Designed for Mobile Applications.													
7189	T-6½	Beam Pent.	9CV	6.3	0.760	S.T.A1 Amp. P.P.AB1 Amp. P.P.AB1 Amp.	13.2	250 400 375	7.3 15 220	48 154.05† 75-81†	5.5 1.6-25† (Cathode Current)	40000	11300	19.5	(G1 to G3)	24000 16500					
7212	T-12	Beam Pent.	8EC	6.3	1.250	P.P.AB1 Amp. P.P.AB1 Amp. P.P.AB2 Amp.	20	600 500 600	45 40 44	180 57-215† 22-207†	1-23† 2-25† 0.6-17†	.....	.....	.....	7000 5500 6800	82000 70000 90000					
7227	T-6½	Pentode	9BA	27.5	0.175	Power Amp.	2.2	27.5	2.5	27.5	1.1	8000	5500	4	.....	70					
7233	T-6½	Triode	9FR	6.3	1.250	Passing Tube for V.R. Serv.	7.5	50	22	.....	120	230	17500	4	.....	.....					
7236	T-12	Duotriode	8BD	6.3	2.400	Passing Tube for V.R. Serv.	15	120	14	.....	100	.....	12500	4.8	.....	.....					
7239	T-6½	Beam Pent.	9KH	6.3	0.300	Pulse Amp. and Shunt Reg.	4.0	300	5.0	100	10.5	300000	4200	.....	.....	.....					
							100	100	.....	43	13.5	(Grid No. 1 = 400 µA. Applied for Short Intervals—2 Sec. Max.)					.....				
7241	TT-18	Triode	7241	6.3	7.500	Passing Tube for V.R. Serv.	100	190	200	.....	550	67	40000	2.7	.....	.....					
								RG = 500 Ohms													
7242	TT-18	Triode	7241	6.3	7.500	Passing Tube for V.R. Serv.	100	100	4	.....	555	82	11000	9.0	.....	.....					
								RG = 500 Ohms													
7244A	T-5½	Duotriode	7BF	6.3	0.450	Amplifier	1.1	100	50	.....	9.0	6300	6000	38	.....	.....					
7245	T-5½	Triode	7BQ	6.3	0.400	VHF Amp.	2.25	150	100	13.5	.....	4500	11000	50	.....	.....					
7246	T-2x3	Triode	7246	1.25	0.150	VHF Amp./Osc./Det.	0.7	105	2.5	.....	4.5	.....	2700	22	.....	.....					
7258	T-6½	Tri. Pentode	9DA	13.5	0.210	Gen. Amp. VHF Amp.	2.8 2.3	150 125	3 56	15 12	3.8	4700 17000	4500 7800	21	.....	.....					
								(Designed for Mobile Operation.)													

7308	T-6½	Twin Triode	9AJ	6.0	0.335	VHF Amp.	1.65	90 100	120 <sup>■</sup> 680 <sup>■</sup>	12 15	11500 12500	33	
7316	T-6½	Duotriode	9A	6.3	0.300	Computer	2.7	250 0	8.5 0	10.5 11.8	7700 6250	17	
7318	T-6½	Duotriode	9A	6.3	0.350	Pulse Amp.	1.35	100 0	0 8.5	11.5 11.5	5800 7000	21.3	
7320	T-6½	Beam Pent.	9CV	6.3	0.760	Power Amp.	12	3000	175	300	7000	16.5	
7327 (3)	T-3	Duotriode	8DG	6.3	0.300	Pulse Amp. Blocking Osc.	0.95	150	3000	175	7000	4.2 (G2 to G1)	
7355	T-9	Beam Pent.	8KN	6.3	0.800	S.T.A1 Amp. P.P.AB1 Amp. P.P.AB1 Amp.	18	250 300 400	15 21 34	225 250 300	62-741 100-1851 56-1751	42000 7600	9000 28500 50001 40000
7358	T-12	Pentode	8EC	6.3	1.250	Pulse Mod.	10	200 3000	100 175	300 300	101 1500 Ohm-Non Ind. Res.	4	
7360	T-6½	Beam Defl. Tube	9KS	6.3	0.350	Balanced Mod. Diode. Sideband	1.5	150 150	1200 <sup>■</sup> 1200 <sup>■</sup>	175 175	0.75 0.75	50001	
7382	T-5½	Triode	7382	6.3	0.300	A-F Amp.	0.55	250	12.5	12	1560	18	
7408	T-9	Beam Pent.	7S	6.3	0.450	A-F Pwr. Amp.	14	250	200 <sup>■</sup>	10	3000	16	
7430	Special	Pentode	7430	6.3	0.200	R-F Amp.	1.87	120 180	2.0 2.0	7.5 7.7	2.5 2.4	300000 5000	
7489	T-6½	Duotriode	9A	6.3/ 12.6	0.300/ 0.150	A-F Amp.	3.0	250 8.5	8.5	10.5	7700	17	
7490	T-6½	Duotriode	9A	6.3/ 12.6	0.600/ 0.300	A-F/D.C. Amp.	5.0	250 4.6	4.6	6.0	2350	32	
7492	T-6½	Duotriode	9DA	6.3/ 12.6	0.300/ 0.150	R-F Amp. and Computer	2.8	250 200 <sup>■</sup>	200 <sup>■</sup>	10	5500	60	
7494	T-6½	Duotriode	9A	12.6/ 6.3	0.150/ 0.300	A-F Amp.	1.1	250 2	2	1.25	59000	95	
7495	T-6½	Beam Tetrode	9K	6.0	0.750	VHF Power Amplifier	12	250 7.5	250	45	7 Max.	7000 G1 to G2=16.	
7496	T-5½	Pentode	7BK	6.3	0.300	R-F Amp.	3.3	250 68 <sup>■</sup>	100	11	4.2	1 Meg.	
7498	T-5½	Pentode	7DB	6.3	0.300	R-F Amp.	3.0	250 160 <sup>■</sup>	250	250	9.85	2.6	
7499	T-6½	Pentode	9BA	6.3	0.750	Video Amp.	12	250 4.5	250	4.0	6.0	11000	
7500	T-6½	Beam Tetrode	9AH	6.3	0.450	A-F Power Amplifier	13	250 12.5	250	45	5.5	50000	
7502	T-5½	Heptode	7CH	6.3	0.300	Converter	1.1	250 1.5	100	3.0	7.5	1.0 Meg.	
7550 (3)	T-3	Duotriode	8DG	6.3	0.525	Pulse Amp.	2.0	300 30	300	1400	Pulse Applied to Grid=+40 V at tp=10 <sup>μ</sup> sec., prr=1000 pps, tr=0.8 <sup>μ</sup> sec. max., tf=1.0 <sup>μ</sup> sec. max	10000	
7551	T-6½	Pentode	9LK	12-15	0.360	RF Amp.	12	300 300	55 42	250 200	80 70	5.1 3.7	
7558	T-6½	Pentode	9LK	6.3	0.800	RF Amp.	.....	.....	.....	.....	.....	.....	

Characteristics Same as Type 6BQ5.

25 Pulse Applied to Grid = 40 Volts at  $T_p = 10 \mu\text{sec.}$ ,  $\text{Prr.} = 1000 \text{ Pps.}$ ,  $\text{Tr.} = 0.2 \mu\text{sec.}$ ,  $\text{Max. I.} = \text{PEAK Plate Current} = 400 \text{ Ma.}$ ,  $\text{Min.}$

Characteristics Same as Type 6V6GT.

Characteristics Same as Type 7551.

TYPE	CONSTRUCTION		EMITTER		USE	Plate Diss. Watts.	Plate Volts	Negative Grid Volts	Screen Volts	Plate Current Ma.	Screen Current Ma.	Screen Current Ma.	Plate Resis. Ohms	Transcon-ductance Micros.	Ampli-fication Factor	Ohms Load	Power Output Milli-watts
	Bulb Size or Style	Class	Basing Diag. 1	Volts													
7561	T-9	Beam Pent.	7561	25	0.300	13	115	8.0	115	55	2.5	2.5	8000	10000	.....	5000	6000
					S.T.A1 Amp.		250	15	150	48-51†	1-7†	.....	.....	.....	.....	3000	17000
7576	T-3	Triode	7576	6.3	0.450	4.1	200	0	.....	15.5	.....	.....	.....	10700	46	.....	.....
					VHF Amp.		250	18	150	50-110†	8-14†	.....	.....	.....	.....	.....	.....
Designed to be Used as a Grounded Grid Amplifier.																	
7581A	T-12	Beam Pent.	75	6.3	0.900	35	250	14	250	72	5	.....	22500	6000	.....	2500	6500
					P.P.AB1 Amp.		360	22.5	270	88-132†	5-15†	.....	.....	.....	.....	6500†	6500
					P.P.AB1 Amp.		450	37	400	116-210†	5.6-22†	.....	.....	.....	.....	5600†	5800
7586	M-N	Triode	12AQ	6.3	0.140	1.0	75	100 <sup>m</sup>	.....	10.5	.....	.....	3000	11500	35	.....	.....
7587	M-N	Tetode	12AS	6.3	0.150	2.2	125	68 <sup>m</sup>	50	10	2.7	20000	10600	.....	.....	.....	.....
7591	T-9	Beam Pent.	8KG	6.3	0.800	19	300	10	300	55-65†	7-16†	.....	29000	10200	.....	4000	11000
					P.P.AB1 Amp.		300	12.5	300	86-116†	12-26†	.....	.....	.....	.....	6600†	23000
					P.P.AB1 Amp.		350	15.5	350	92-130†	13-29†	.....	.....	.....	.....	6600†	30000
					P.P.AB1 Amp.		400	16	350	85-143†	11-27†	.....	.....	.....	.....	6600†	37000
					P.P.AB1 Amp.		450	16.5	350	77-153†	10-27†	.....	.....	.....	.....	6600†	43000
					P.P.AB1 Amp.		450	21	400	66-144†	9.4-30†	.....	.....	.....	.....	6600†	45000
					P.P.AB1 Amp.		450	200 <sup>m</sup>	400	82-94†	11.5-22†	.....	.....	.....	.....	9000†	28000
					P.P.AB1 Amp.		400	20.5	.....	80-138†	11.5-26†	.....	.....	.....	.....	6600†	32000
					P.P.AB1 Amp.		425	185 <sup>m</sup>	.....	88-104†	13-17.5†	.....	.....	.....	.....	6600†	26000
7631	T-5½	Duodiode	6BT	6.3	0.300	.....	.....	.....	.....	.....	.....	.....	.....	.....	.....	.....	.....
					Detector		.....	.....	.....	.....	.....	.....	.....	.....	.....	.....	.....
					Max. Peak Inverse Plate Voltage = 360 Volts.		.....	.....	.....	.....	.....	.....	.....	.....	.....	.....	.....
					Max. Surge Plate Current = 350 Ma.		.....	.....	.....	.....	.....	.....	.....	.....	.....	.....	.....
7643	T-6½	Tri. Pent.	9AE	6.3	0.330	1.7	100	120 <sup>m</sup>	170	10	14	.....	400000	6200	40	.....	.....
					VHF Amp./Osc.		2.1	170	155 <sup>m</sup>	.....	.....	.....	.....	.....	.....	.....	.....
7687	T-6½	Tri. Pentode	9AE	6.3	0.500	2.4	215	8.5	.....	7.5	.....	.....	7200	2500	18	.....	.....
					A-F Amp.		3.0	220	62 <sup>m</sup>	130	10	3.4	500000	5800	.....	.....	.....
7688	Special Base T-7½	Triple Triode	12BA	6.3	0.450	3.0	.....	.....	.....	.....	.....	.....	.....	.....	.....	.....	.....
					Characteristics Same as Type 12AU7.		.....	.....	.....	.....	.....	.....	.....	.....	.....	.....	.....
7689	Special Base T-7½	Triple Triode	12BA	6.3	0.450	1.1	.....	.....	.....	.....	.....	.....	.....	.....	.....	.....	.....
					Characteristics Same as Type 12AX7.		.....	.....	.....	.....	.....	.....	.....	.....	.....	.....	.....
7680	Special Base T-7½	Triple Triode	12BA	6.3	0.450	2.8	.....	.....	.....	.....	.....	.....	.....	.....	.....	.....	.....
					Characteristics Same as Type 12AT7.		.....	.....	.....	.....	.....	.....	.....	.....	.....	.....	.....
7693	T-5½	Pentode	7EN	6.3	0.150	2.6	250	100 <sup>m</sup>	150	7.4	2.9	1.3 Meg.	4600	G1 to G2 = 48	.....	.....	.....
7694	T-5½	Pentode	7EN	6.3	0.150	3.3	250	80 <sup>m</sup>	100	9.2	3.3	1.0 Meg.	3800	G1 to G3 = 25	.....	.....	.....
7695	9-T9	Pentode	9PX	50	0.150	16	130	11	130	100	5-14†	.....	7000	11000	.....	1100	4500
					S.T.A1 Amp.		140	50 <sup>m</sup>	140	210-220†	9-20†	.....	.....	.....	.....	1500†	10000
					P.P.AB1 Amp.		.....	.....	.....	.....	.....	.....	.....	.....	.....	.....	.....
7701	T-6½	Beam Pent.	9MS	13.6	0.160	9.0	250	12.5	250	28	3.1	31000	3600	.....	.....	.....	.....
					VHF Class C Amplifier		.....	.....	.....	.....	.....	.....	.....	.....	.....	.....	.....
7716	T-6½	Tri. Pentode	9DX	13.6	0.350	1.0	125	1.0	.....	1.5	.....	.....	35000	2900	102	.....	.....
					High Mu High GM		5.0	200	68 <sup>m</sup>	125	24	5.2	70000	10000	.....	.....	.....
7717	T-5½	Tetode	7EW	6.3	0.200	2.0	125	1.0	80	10	1.4	125000	8000	.....	.....	.....	.....
7719	T-6½	Triode	9MX	12½/6.3	0.225/0.450	6.0	300	10.5	.....	4	.....	.....	7100	3500	25	.....	.....



7720	Ceramic and Metal	Triode	7720	6.3	0.240	VHF Amp.	1.0	150	82 <sup>#</sup>	7.5	10500	90		
7721	T-6½	Pentode	9EQ	6.3	0.320	VHF Amp.	4.0	190	400 <sup>#</sup>	160	22	6.0	120000	35000
7722	T-6½	Pentode	9EQ	6.3	0.320	VHF Amp.	4.0	190	370 <sup>#</sup>	160	20	6.0	100000	26000
7724	T-6½	Duodiode Tri.	9KR	14	0.150	A-F Amp.		250	3.0	0.7			72000	1000
7728	T-6½	Duodiode	9A	6.3/ 12.6	0.300/ 0.150	VHF Amp.	2.8	Characteristics Same as Type 12AT7.						
7729	T-6½	Duodiode	9A	6.3/ 12.6	0.300/ 0.150	A-F Amp.	1.1	Characteristics Same as Type 12AX7.						
7730	T-6½	Duodiode	9A	6.3/ 12.6	0.300/ 0.150	Gen. Purpose	3.0	Characteristics Same as Type 12AU7.						
7731	T-6½	Tri. Pent.	9AE	6.3	0.450	VHF Osc. VHF Amp.	3.0	Characteristics Same as Type 6U8.						
7732	T-5½	Pentode	7CM	6.3	0.300	VHF Amp.	2.3	Characteristics Same as Type 6CB6.						
7733	T-6½	Pentode	9BF	6.3/ 12.6	0.600 0.300	Video Amp.	6.5	Characteristics Same as Type 12BY7A.						
7734	T-6½	Tri. Pentode	9LC	6.3	0.900	V.R. Voltage Control Tube	7.0	150	21	35	5.5	1.7	1080	5000
							1.0	150	2.0	150	2.0	1.7	340000	3200
7737 (3)	T-6½	Pentode	9MZ	6.3	0.320	Amplifier	3.0	180	100 <sup>#</sup>	150	11.5	2.9		15900
7738	T-5½	Triode	7DK	6.3	0.225	VHF Class C Amplifier	5.0	200	100 <sup>#</sup>		12			9500
7751	T-9	Beam Pent.	7S	6.3	1.200	Pulse Amp.	10	100	8.2	100	100	7	5000	14000
7754	9-19	Beam Pent.	9PX	6.3	1.200	A-F Power Amplifier	16	Characteristics Same as Type 7695.						
7759	T-3	Duodiode	8DG	26.5	0.090	VHF Amp./ Osc.	1.1	100	150 <sup>#</sup>		6.5		5400	35
7760	T-3	Duodiode	8DG	26.5	0.090	VHF Amp./ Osc.		26.5	2.2 Meg <sup>†</sup>		3		5000	20
7761	T-3	Pentode	8DL	26.5	0.110	Video Amp.	4.0	150	100 <sup>#</sup>	100	21	4	50000	9000
7762	T-3	Beam Pent.	8DL	26.5	0.110	S.T. A1 Amp.	4.0	110	270 <sup>#</sup>	110	30	2.2	15000	4200
7763 (3)	T-6½	Sheet Beam Tube	9NF	6.3	0.300	I-F Amp. Limiter	0.75	135					3000	1000
7768	Ceramic and Metal	Triode	7768	6.3	0.400	VHF Amp.	5.5	200	270 <sup>#</sup>		24		4500	50000
7803	T-6½	Duodiode	9AJ	6.3	0.365	VHF Osc. Doubling	3.5	90	1.3		15		12500	33
								160	70		26			
7841	Ceramic and Metal	Diode	7841	6.3	0.215	Detector		Max. Peak Inverse Plate Voltage = 350 Volts. Max. D.C. Output Current = 5.0 Ma.						
7861	T-6½	Duodiode	8CJ	12.6	0.175	Gen. Purpose	1.3	150	240 <sup>#</sup>		8.2		6400	5500
7867	T-12	Beam Pent.	5BT	6.3	2.500	S.T. A1 Amp. P.P.AB1 Amp. P.P.AB1 Amp.	24	250	120 <sup>#</sup>	90	80	1.0	12000	10000
								250	200 <sup>#</sup>	150	114-128†	2-17†	6000†	7500
								250	35	150	58-210†	1.4-26†	6000†	65000

Total Plate Current = 4.2 Ma.  
Deflection Electrode = 135 Volts. Acc. and Screen Current = 4.0 Ma.  
G1 = +6 Volts

Rg1 = 33K Ohms (Class "C" Doubler to 175 Mc)  
Igl = 2.5 Ma. PK R-F Grid Volts = 77

TYPE	CONSTRUCTION		EMITTER		USE	Plate Diss. Watts?	Plate Volts	Negative Grid Volts	Screen Volts	Plate Current Ma.	Screen Current Ma.	Plate Resis. Ohms	Transcon-ductance Micros.	Ampli-fication Factor	Ohms Load for Stated Power Output	Power Output Milli-watts
	Bulb Size or Style	Class	Basing Diag.†	Amps.												
7868	Novar T-9	Beam Pent.	9NZ	6.3	0.800	19	300	10	300	60	8	29000	10200	.....	3000	11000
					S.T. A1 Amp.		300	12.5	300	74-116†	10-28†			.....	6600†	24000
					P.P. AB1 Amp.		400	16	350	64-135†	8-28†			.....	6600†	34000
7887	T-3	Duotriode	8DG	26.5	0.090	1.1	100	220 <sup>■</sup>	.....	8.5	.....	.....	5000	20	.....	.....
7888	T-3	Triode	8DK	26.5	0.045	UHF Osc.	1.0	100	150 <sup>■</sup>	8.5	.....	.....	5800	27	.....	.....
					UHF Osc.		150	180 <sup>■</sup>	.....	13	.....	.....	6000	27	.....	.....
7889	T-3	Duotriode	8DG	26.5	0.090	A-F Amp.	0.55	100	1500 <sup>■</sup>	0.8	.....	.....	1800	70	.....	.....
					A-F Amp.		150	820 <sup>■</sup>	.....	1.75	.....	.....	2500	70	.....	.....
7898	T-6½	Duotriode	9EP	13.5	0.150	VHF Osc./ Amp.	2.75	250	200 <sup>■</sup>	.....	10	.....	10900	5500	60	.....
7905	T-6½	Beam Pent.	9PB	6.3	0.650	VHF Class "C" Power Amp.	10	200	6	185	2.5	.....	6700	.....	.....	.....
					VHF Class "C" Power Amp.		300	39	185	60	4	.....	.....	.....	.....	.....
7984	T-12	Beam Pent.	12CN	13.5	0.580	Class "C" Amp. 175 Mc.	35	200	7.5	125	12	.....	13500	.....	.....	.....
7994	T-3	Triode	8KM	6.3	0.250	VHF Amp.	2.0	100	82 <sup>■</sup>	13.0	.....	.....	2200	18000	41	.....
7995	T-3	Pentode	8KZ	6.3	0.250	R-F I-F Amp.	1.6	150	160 <sup>■</sup>	150	8.0	.....	85000	13000	.....	.....
8056	M-N	Triode	12AQ	6.3	0.135	VHF Amp.	0.45	24	100 <sup>■</sup>	.....	8.7	.....	1530	7500	11.5	.....
8058	M-N	Triode	12CT	6.3	0.135	UHF Amp.	1.5	110	47 <sup>■</sup>	.....	10	.....	5600	12400	70	.....
8064	T-3	Beam Pent.	8DL	26.5	0.045	VHF Amp.	0.75	100	120 <sup>■</sup>	100	7.2	.....	275000	4500	.....	.....
8068	T-12	Beam Pent.	8LC	6.3	0.900	Series Reg.	35	3500	30	100	1.0	.....	54500	5200	.....	.....
					Series Reg.		600	7.5	125	36	1.0	.....	11000	58	.....	.....
8070	T-3	Triode	8LD	6.3	0.125	UHF Amp.	1.0	110	130 <sup>■</sup>	.....	7.5	.....	.....	.....	.....	.....
8071 (3)	T-3	Triode	8LE	6.3	0.125	UHF Amp.	2.0	150	100 <sup>■</sup>	.....	11.5	.....	.....	.....	.....	.....
8084 (3)	T-5½	Pentode	7CM	13.5	0.160	VHF Freq. Multiplier	2.3	125	1	80	7.0	.....	10500	.....	.....	.....
8102 (3)	T-6½	Tri. Pentode	9PJ	13.5	0.230	Gen. Purpose Amp.	2.5	125	1	.....	13.5	.....	5400	46	.....	.....
					Gen. Purpose Amp.		125	1	125	12.0	4.0	.....	20000	7500	.....	.....
8103 (3)	T-3	Double Tri.	8DG	26.5	0.075	UHF Amp. UHF Osc.	.....	26.5	2.2	.....	5.5	.....	.....	.....	.....	.....
					UHF Amp. UHF Osc.		.....	.....	.....	.....	.....	.....	.....	.....	.....	.....
8106 (3)	T-6½	Pentode	9PL	13.5	0.250	Frequency Multiplier	6.0	300	3.5	150	3.2	.....	9000	.....	.....	.....
8113 (3)	T-5½	Tetrode	7EW	6.3	0.200	R-F Amp.	2.0	120	2.0	120	2.3	.....	20000	7000	.....	.....
8136	T-5½	Pentode	7CM	6.3	0.300	VHF Amp.	2.2	125	56 <sup>■</sup>	125	10.8	.....	9800	.....	.....	.....
8149	Comp. T-12	Beam Pent.	12DT	6.5	1.200	R-F Power Amp.	35.0	420	24	180	165	.....	7500	4.5	.....	.....
8150	Comp. T-12	Beam Pent.	12DU	6.5	1.200	R-F Power Amp.	35.0	420	24	180	165	.....	7500	4.5	.....	.....
					R-F Power Amp.		.....	.....	.....	.....	.....	.....	.....	.....	.....	.....
8156	Comp. T-9	Beam Pent.	12EU	13.5	0.300	R-F Pwr. Amp.	15.0	200	9	125	75	.....	7600	.....	.....	.....
8185 (3)	T-3	Triode	8KM	6.3	0.300	R-F Pwr. Amp.	4.25	200	220 <sup>■</sup>	.....	17.0	.....	19000	42	.....	.....

Characteristics Same as Type 8149. (8150 has Top Cap Construction.)

8186 (3)	T-3 Triode	8KM	26.5	0.075	R-F Pwr. Amp.	4.25	Characteristics Same as Type 8185.						
8210 (3)	T-3 Pentode	8LS	6.3	0.125	VHF Mixer	1.1	100	100 <sup>■</sup>	100	7.5	2.5	260000	8500
8211 (3)	T-3 Pentode	8DL	6.3	0.360	Video Amp.	4.0	150	62 <sup>■</sup>	100	17.0	4.2	65000	15500
8212 (3)	T-6½ Triode	9PY	6.3	0.460	Cathode Follower	10.0	105	75 <sup>■</sup>	.....	25.0	.....	965	29000
8213 (3)	T-3 Triode	8LT	6.3	0.360	Cathode Follower	5.0	105	75 <sup>■</sup>	.....	23.0	.....	1348	23000
8223 (3)	T-6½ Twin Triode	9AJ	6.3	0.475	A-F R-F Amp.	3.0	60	80 <sup>■</sup>	.....	15	.....	1850	14000
8233 (3)	T-9 Pentode	9PZ	6.3	0.600	Power Amp.	10.0	125	3	125	50	5.5	20000	45000
8254 (3)	T-3 Triode	8LW	6.3	0.185	High Freq. Probe Tube	1.5	80	2	.....	14	.....	.....	14500
8278 (3)	Novar T-9 Tetrode	9QB	6.3	1.200	Power Amp.	25.0	250	12.5	250	100	8.0	7300	24000
8319 (3)	T-3 Triode	8LD	6.3	0.150	I-F R-F Amp.	1.0	100	160 <sup>■</sup>	.....	7.5	.....	14000	55
8334 (3)	T-5½ Triode	7DK	6.3	0.225	UHF Amp.	4.4	200	100 <sup>■</sup>	.....	18	.....	10750	55
8356	T-6½ Twin Beam Pent.	9QR	1.9	3.150	R-F Osc.	7.5	180	20	180	50	11.5	.....	10000
8380	M-N Tetrode	12AS	6.0	.....	Freq. Doubler R-F Osc.	1.6	100	68 <sup>■</sup>	50	11	2.6	.....	11000
8382	M-N Triode	12AQ	6.0	.....	Class C Amp. R-F Osc.	2.0	75	100 <sup>■</sup>	.....	15	.....	2200	12800
8414 (3)	T-3 Pentode	8DC	26.5	0.045	VHF Amp.	.....	26.5	2.2 Meg. <sup>4</sup>	26.5	4.5	1.5	50000	5000
8417	T-12 Beam Pent.	7S	6.3	1.600	Power Amp.	35.0	300	12	300	100	5.5	16000	23000
8425 (3)	T-5½ Pentode	7BK	6.3	0.300	I-F R-F Amp.	3.5	250	68 <sup>■</sup>	150	10.5	4.1	1100000	6200
8426 (3)	T-5½ Pentode	7BK	12.6	0.150	I-F R-F Amp.	3.5	Characteristics Same as Type 8425.						
8431	T-6½ Double Tri.	9AJ	12.6	0.180	Class C Amp.	3.5	90	1.3	.....	15	.....	.....	12500
8441	M-N Triode	12AQ	6.0	.....	Amplifier	1.0	110	150 <sup>■</sup>	.....	7	.....	6800	9400
8444 (3)	T-3 Pentode	8DC	6.3	0.125	VHF Amp.	1.1	100	100 <sup>■</sup>	100	8.5	2.8	260000	9000
8445 (3)	T-6½ Triode Pent.	9AE	6.75	0.440	Gen. Purpose Amp.	2.0	100	1	.....	12.5	.....	7000	43
8446 (3)	T-6½ Triode Pent.	9FA	6.75	0.440	Gen. Purpose Amplifier	2.0	170	2	170	10.0	2.5	400000	6200
8447 (3)	T-6½ Double Diode Triode	9CF	6.75	0.380	Det. Amp.	.....	Diode Voltage Drop for I <sub>b</sub> = 17 Ma = 50 Volts.						
8448 (3)	T-6½ Pentode	9BF	6.75	0.520	Power Amp.	6.5	250	100 <sup>■</sup>	180	26	5.7	93000	11000
8456 (3)	M-N Triode	12AQ	6.0	.....	Cathode Follower	0.45	24	100 <sup>■</sup>	.....	8.7	.....	1530	7500
8489 (3)	T-6½ Tri. Pentode	9DA	6.3	0.450	Amplifier	2.8	150	3	125	15.0	3.8	4700	4500
8532	T-5½ Triode	7BQ	6.3	0.400	UHF Amp.	2.5	150	100 <sup>■</sup>	.....	13.5	.....	4800	11000
8632	T-9 Triode	.....	6.3	0.300	Shunt Reg. Pulse Amp.	18	Max. Anode Voltage = 18,000 Volts. Max. Negative Grid Voltage = 200 Volts; Max. Peak Plate Current = 100 Ma.						
9001	T-5½ Pentode	7BD	6.3	0.150	VHF Amp.	0.55	250	3.0	100	2.0	0.7	1 Meg. >	1400

TYPE	CONSTRUCTION		EMITTER		USE	Plate Diss. Watts:	Plate Volts	Negative Grid Volts	Screen Volts	Plate Current mA.	Screen Current mA.	Plate Resis. Ohms	Transcon-ductance Micros.	Ampli- fication Factor	Ohms Load for Stated Power Output	Power Output Milli- watts
	Bulb Size or Style	Class	Basing Diag.	Volts												
9002	T-5½	Triode	7B5	6.3	0.150	1.76	250	7.0	.....	6.3	.....	11400	2200	25	.....	.....
9003	T-5½	Pentode	7B5	6.3	0.150	1.87	250	3.0	100	6.7	2.7	700000	1800	.....	.....	.....
XXD	Now Listed as 14AF7/XXD															
XXFM	Now Known as Type 7X7															
XXL	Now Known as Type 7A4															

**NOTES:** (1) See Basing Diagram Section. (3) Has Special Mechanical and/or Life Characteristics. † Maximum Signal. ■ Cathode Resistor (ohms).  
 (2) Design Maximum Values. (4) Average Contact Potential Bias Developed Across Specified Grid Resistor. ▲ Conversion Transconductance. ‡ Plate to Plate.

## BASING DIAGRAMS FOR RECEIVING TUBE CONDENSED DATA CHART

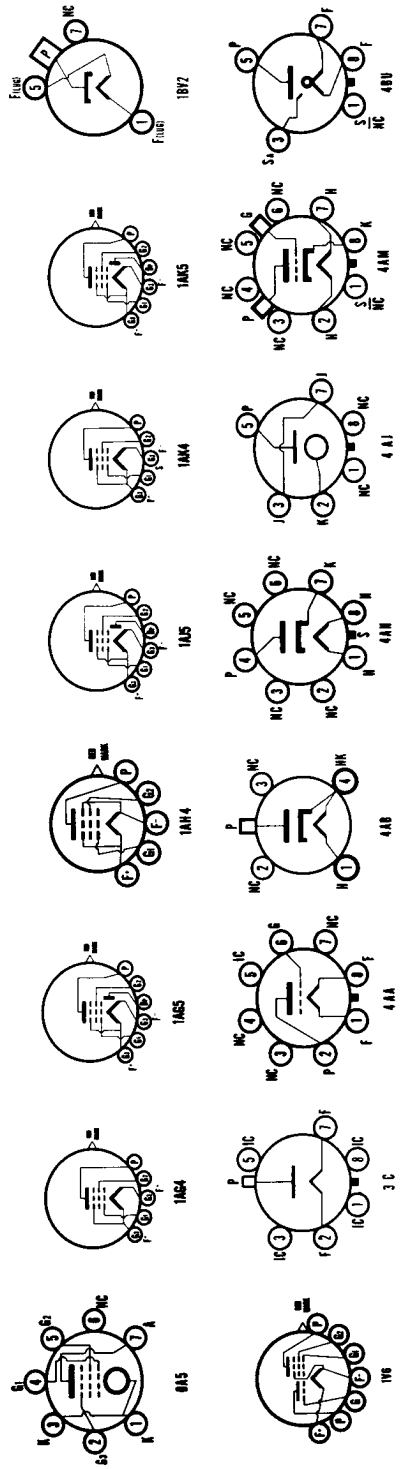

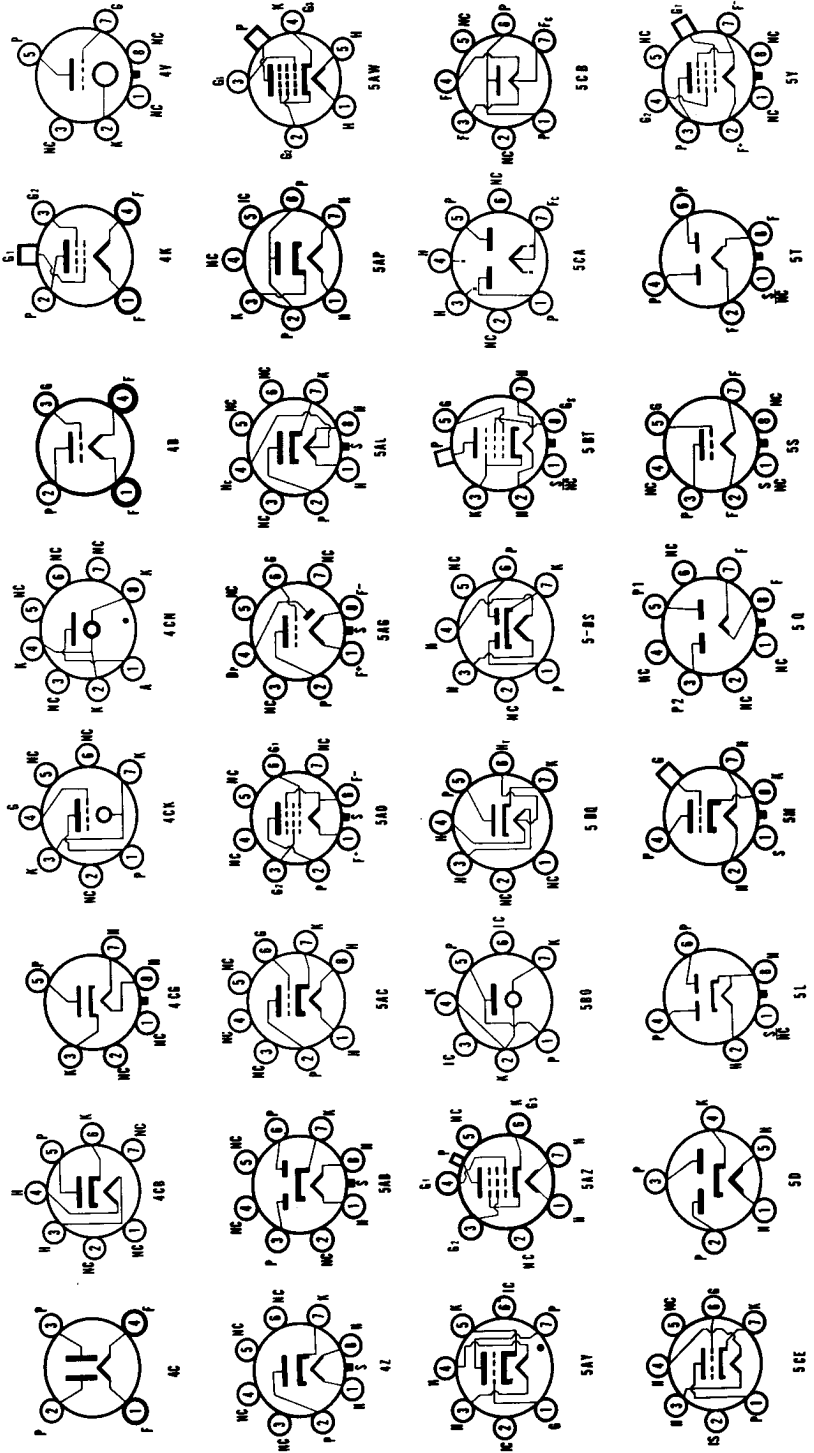

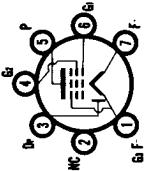

6AU

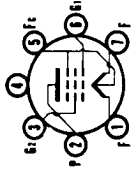

6B

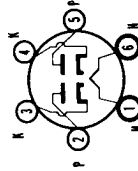

6E

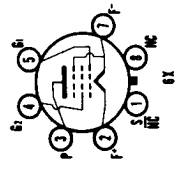

6X

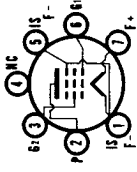

6AR

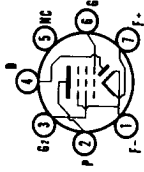

6-BW

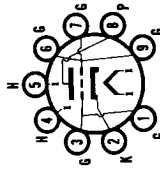

6DL4

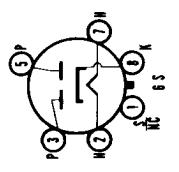

6H

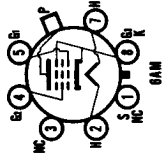

6AM

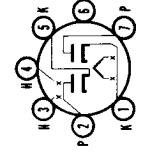

6BT

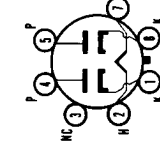

6CN

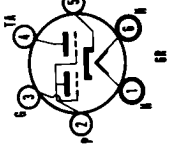

6H

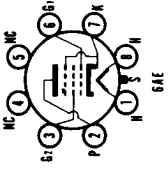

6AE

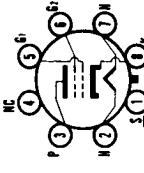

6BS

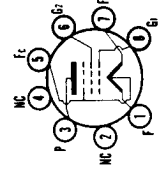

6EL

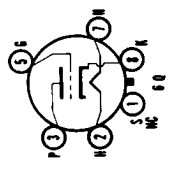

6Q

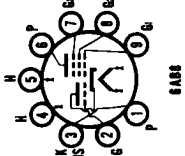

6AB8

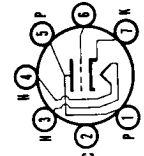

6BE

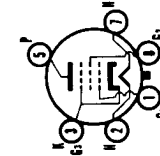

6CK

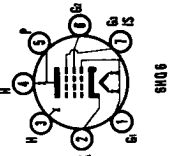

6H06

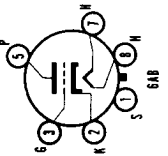

6AB

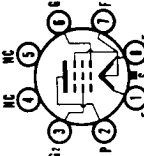

6BA

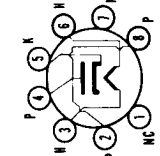

6C1

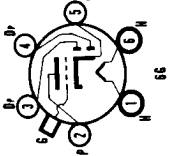

6E

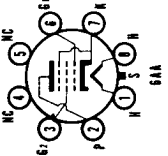

6A

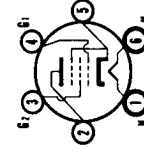

6B

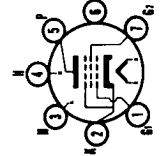

6CN

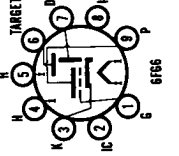

6EG6

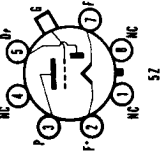

6Z

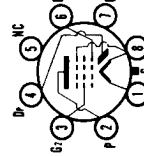

6AX

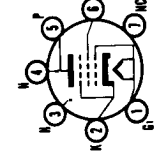

6CC



6F



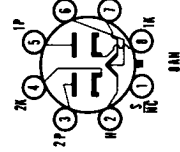
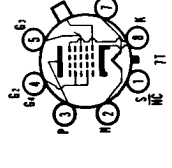
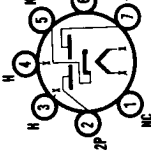
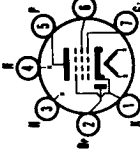
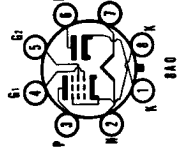
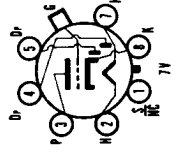
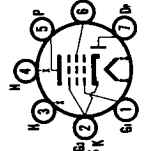
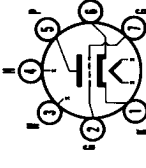
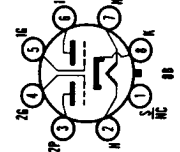
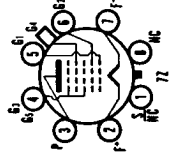
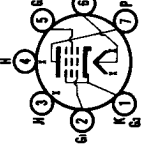
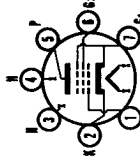
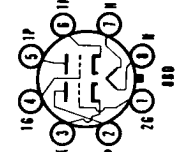
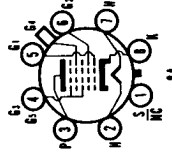
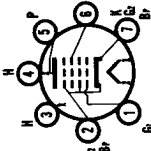
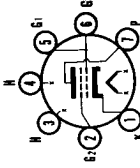
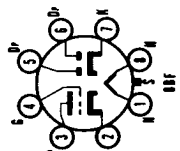
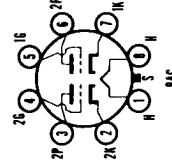
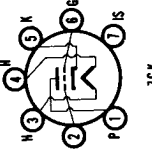
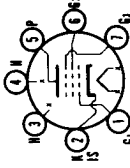
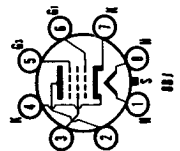
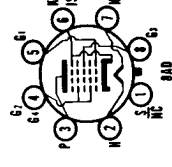
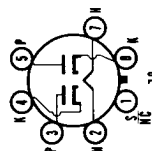
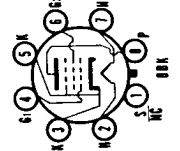
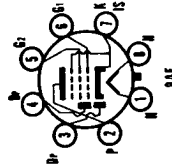
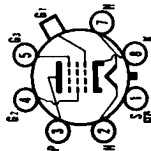
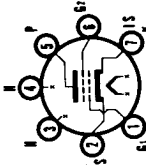
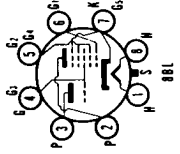
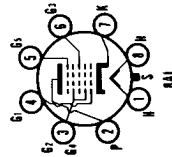
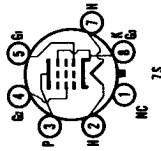
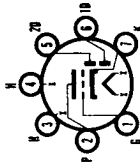





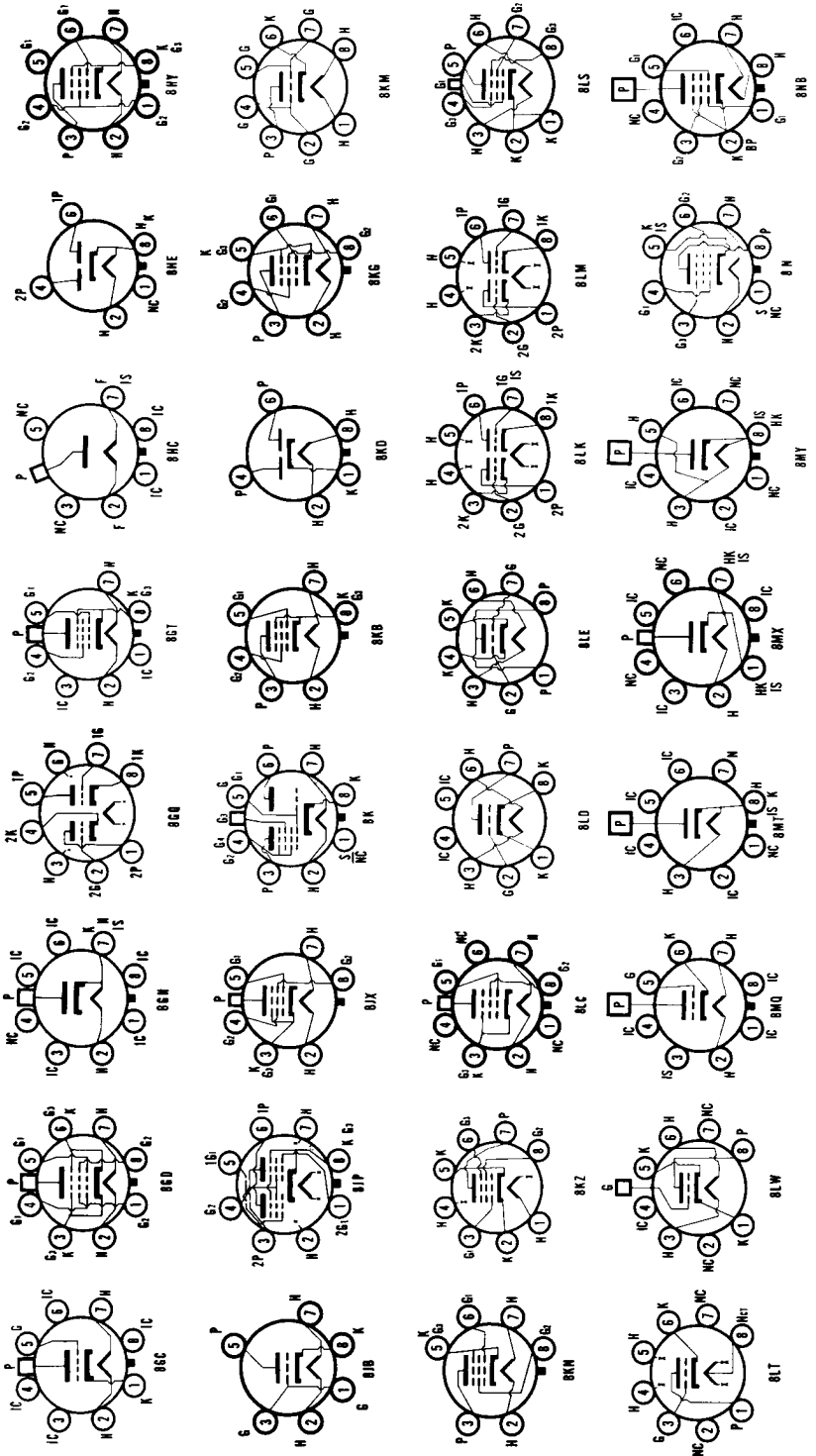



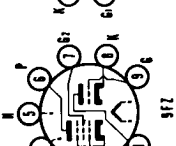
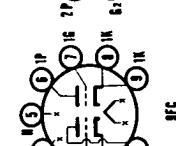
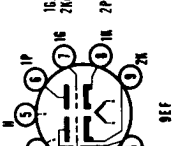
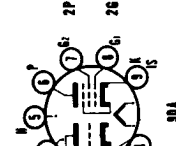
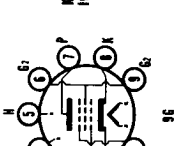
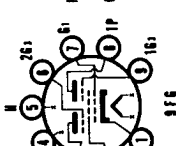
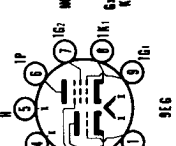
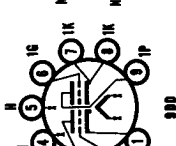
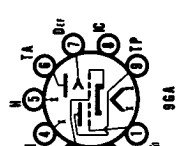
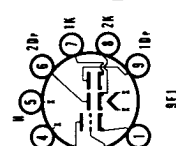
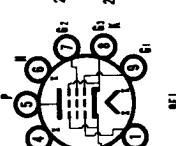
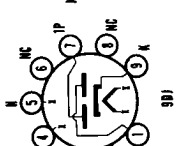
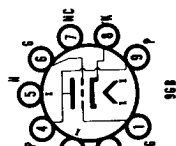
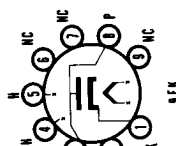
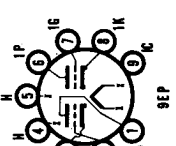
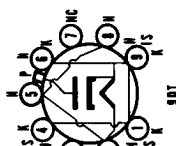
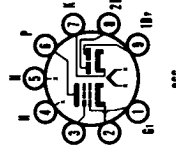
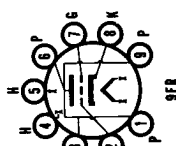
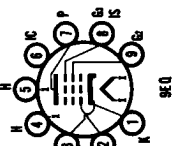
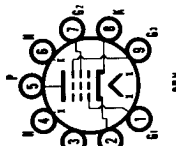
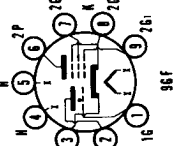
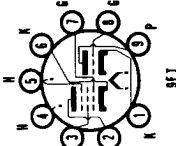
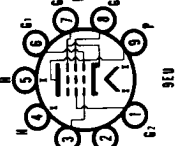
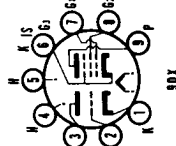
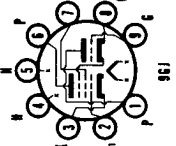
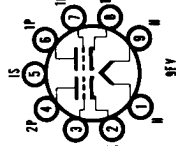
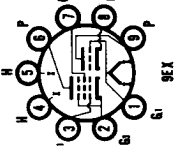
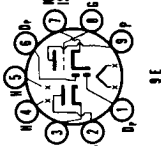
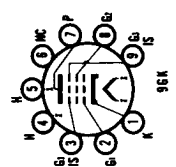
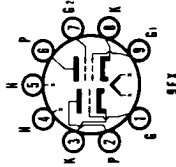
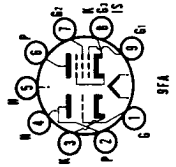
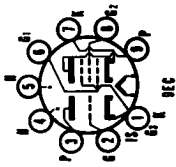

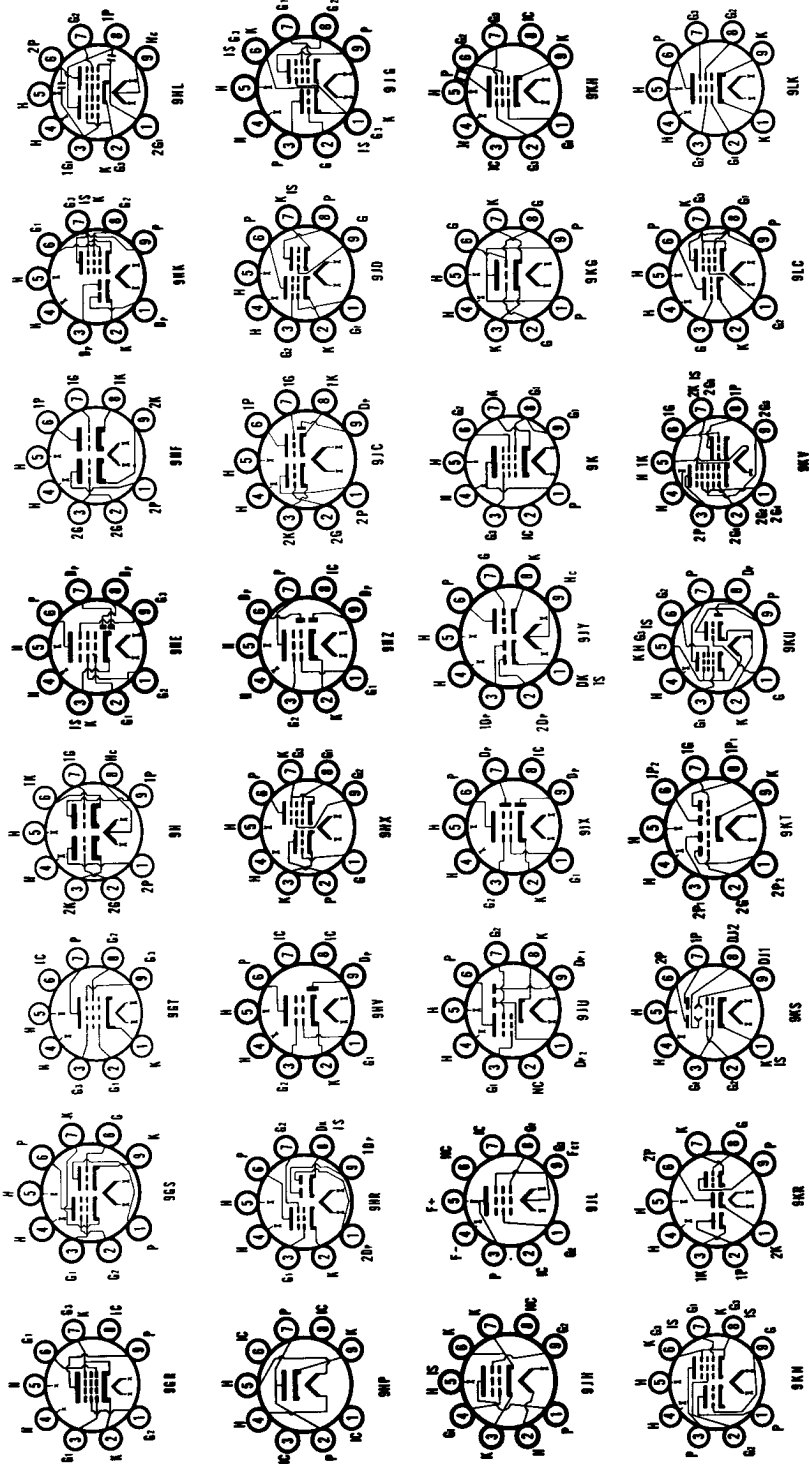





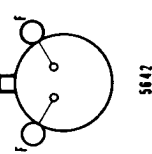
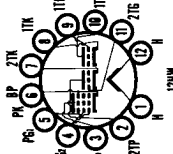
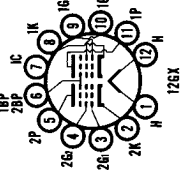
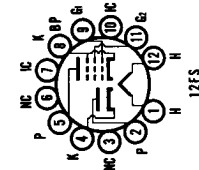
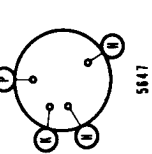
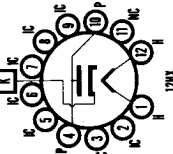
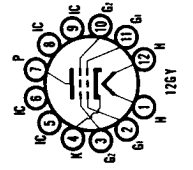
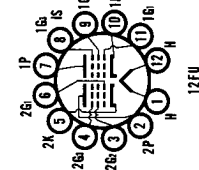
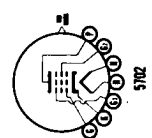
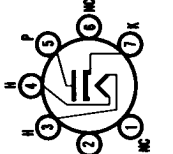
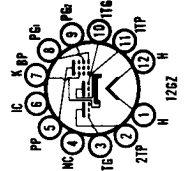
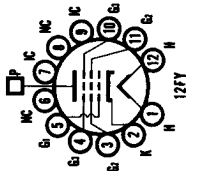
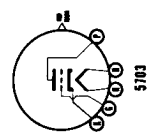
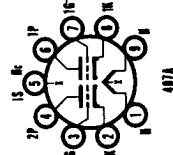
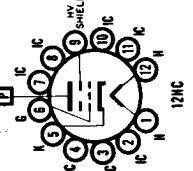
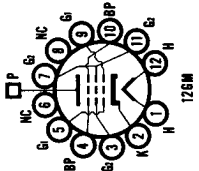
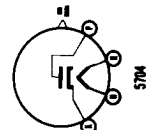
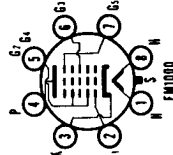
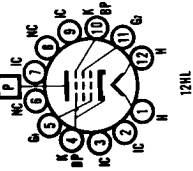
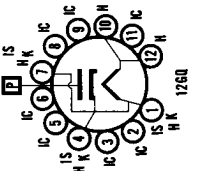
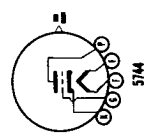
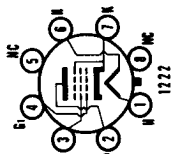
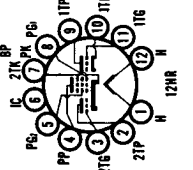
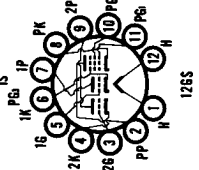
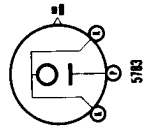
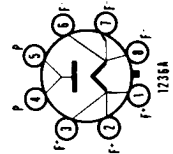
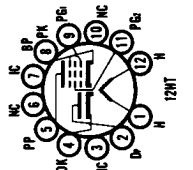
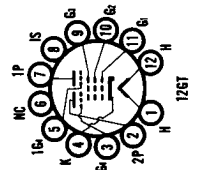
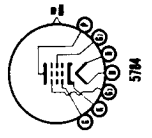
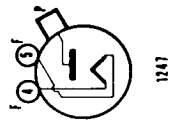
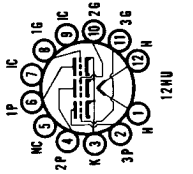
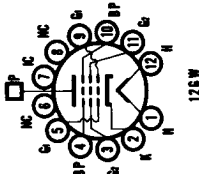



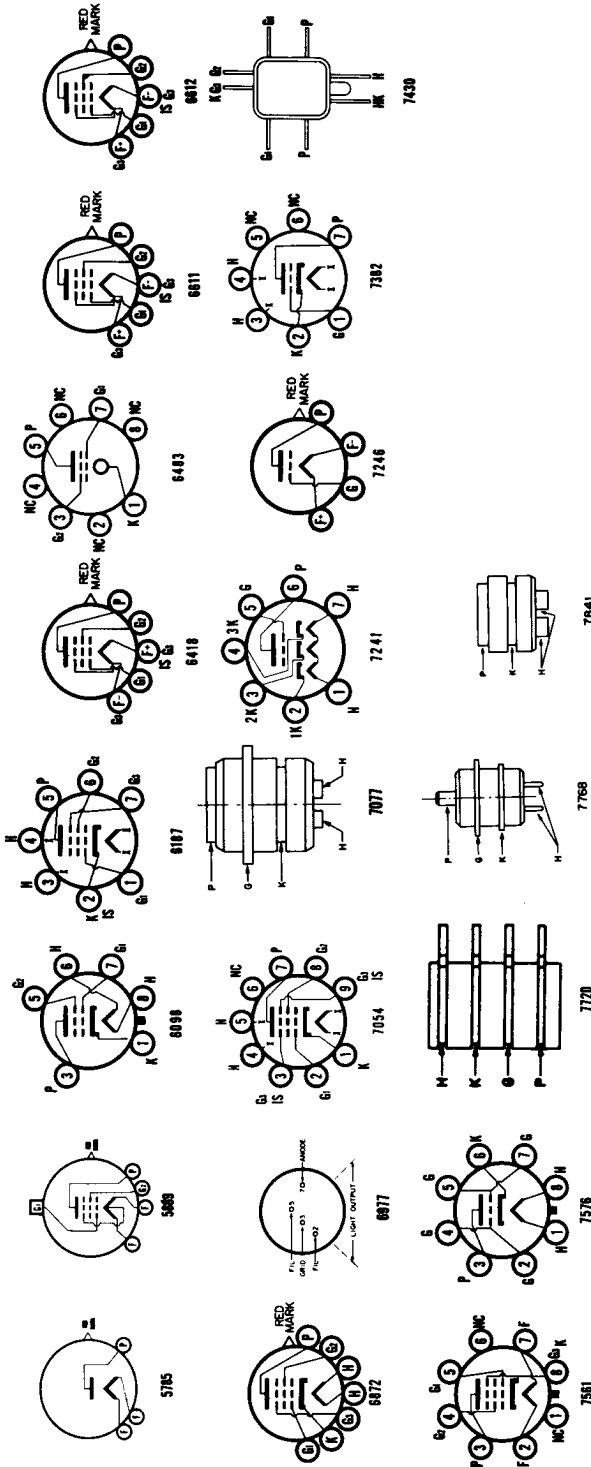

**BASING DIAGRAM SYMBOLS**

<b>A</b> — Anode	<b>Hc</b> — Heater Center Tap	<b>P</b> — Plate
<b>Dp</b> — Diode Plate	<b>Ht</b> — Heater Tap	— Metal Shell
<b>F</b> — Filament	<b>IC</b> — Internal Connection	<b>SA</b> — Starter Anode
<b>Fc</b> — Filament Center Tap	<b>IS</b> — Internal Shield	<b>T</b> — Target
<b>G</b> — Grids numbered according to their position from the cathode	<b>J</b> — Jumper	<b>XS</b> — External Shield
<b>H</b> — Heater	<b>K</b> — Cathode	□ — Top Cap
	<b>NC</b> — No Connection	■ — Locating Key

# GENERAL DATA — Receiving Tubes

## SCREEN VOLTAGE RATINGS\*

The voltage for the screen of a tube may be obtained from either a fixed source or through a screen dropping resistor. A voltage source is considered "fixed" if the regulation is such that no significant change in voltage takes place with variations in current.

The tube data sheets may show a maximum screen voltage, or a maximum screen supply voltage. When a maximum screen voltage is shown, the voltage measured at the screen terminal should not exceed such value under any circuit operating condition. When a maximum screen supply voltage is shown the screen voltage may be permitted to reach the rated supply voltage provided that the screen dissipation (screen current in amperes multiplied by the voltage appearing directly at the screen terminal) is held within certain specified values as indicated in Chart A.

The chart represents the maximum permissible screen dissipation (as a percent of the maximum screen dissipation rating) at any screen voltage operating point. The chart shows that full rated screen dissipation is permissible up to 50% of the maximum rated screen supply voltage. From the 50% point to the full value of rated supply voltage the decrease in the allowable screen dissipation follows a curve of the parabolic form. The chart is of universal use for cases where either a fixed screen voltage or a series screen dropping resistor is used.

In the case where fixed screen applied voltage is desired it is necessary only to determine that the screen dissipation is within the boundary of the chart at the screen voltage to be used. In the case where a screen voltage dropping resistor is to be used it is necessary to determine the resistor value such that the dissipation in the screen grid is again within the same boundary of the chart. It is to be noted that the minimum value of the voltage dropping resistor is given by the factor.

$$\frac{E_{cc2}^2}{4 P_{g2}}$$

where  $E_{cc2}$  is the selected screen supply voltage and  $P_{g2}$  is the maximum screen dissipation rating for the type.

To illustrate the use of the chart, let it be assumed that the tube data for a type stipulate ratings of 300 volts maximum screen supply voltage, and 1.0 watt maximum screen dissipation. If it is desired

CHART A  
Grid No. 2 Rating Chart

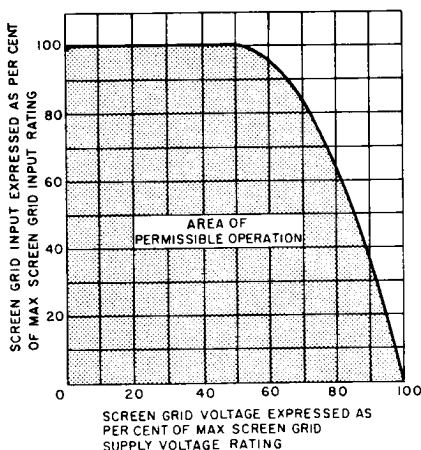

to operate the tube at 200 volts (66⅔% of the maximum screen supply voltage rating) applied directly to the screen, the maximum allowable screen dissipation at this point (refer to Chart A) is 88% of the maximum screen dissipation, or 0.88 watt.

On the other hand, if it is desired to operate the same tube with a screen dropping resistor, the maximum screen voltage must not exceed the 300 volt rating, and the dropping resistor must be selected to hold the dissipation within the safe ratings. To assure that the tube will operate within the rating curve the dropping resistor can be determined from the formula

$$R_{c2} > \frac{E_{cc2}^2}{4 P_{g2}}$$

where

$R_{c2}$  is the screen dropping resistor (ohms),

$E_{cc2}$  is the selected screen supply voltage (volts),

$P_{g2}$  is the maximum screen dissipation rating (watts).

For example, if a screen supply voltage of 250 volts were selected for the above cited tube type

$$R_{c2} > \frac{250^2}{4 \times 1.0} = \frac{62500}{4} = 15625 \text{ ohms}$$

\*This material was formulated by the Committee on Receiving Tubes of the Joint Election Tube Engineers Council and approved by the Council as JEDEC Data.

## RECEIVING TUBE REPLACEMENT GUIDES

	<b>Page</b>
<b>Sylvania Double/Brand Replacement Guide</b> .....	<b>490</b>
<b>Foreign-American Receiving Tube Replacement Guide</b> .....	<b>492</b>
<b>Industrial Receiving Tube Replacement Guides</b> .....	<b>500</b>

# Sylvania Double/Brand Replacement Guide

TUBE TYPE	SYLVANIA DOUBLE/BRAND
1B3GT 1G3GT	1G3GT/1B3GT
1J3 1K3	1K3/1J3
1S2A	1S2A/DY87
2AF4 2AF4A 2AF4B	2DZ4/2AF4B
2AS2A 2BU2	2BU2/2AS2A
2DZ4	2DZ4/2AF4B
2FQ5A 2GK5	2GK5/2FQ5A
3AF4 3AF4A 3AF4B	3DZ4/3AF4B
3BC5	3BC5/3CE5
3BU8	3GS8/3BU8
3CB6	3CB6/3CF6
3CE5	3BC5/3CE5
3CF6	3CB6/3CF6
3DHH13	3FX7/3DHH13
3DZ4	3DZ4/3AF4B
3EH7	3EH7/XF183
3FX7	3FX7/3DHH13
3EJ7	3EJ7/XF184
3GS8	3GS8/3BU8
3HA5 3HM5	3HA5/3HM5
4BL8	4BL8/XCF80
4BQ7 4BQ7A	4BQ7A/4BZ7
4BU8	4GS8/4BU8
4BZ7	4BQ7A/4BZ7
4GS8	4GS8/4BU8
4HA5	4HA5/PC900
4HA7 4HC7	4HA7/4HC7
4KN8	4RHH8/4KN8
4RHH2 4RHH8	4BQ7A/4BZ7 4RHH8/4KN8
5AR4	5AR4/GZ34

TUBE TYPE	SYLVANIA DOUBLE/BRAND
5HG8	5HG8/LCF86
5U9	5U9/LCF201
6AB8	6AB8/ECL80
6AF4 6AF4A	6DZ4/6AF4A
6AK5	6AK5/EF95
6AK8	6AK8/EABC80
6AL3	6AL3/EY88
6AQ8	6AQ8/ECC85
6BA6	6BA6/EF93
6BC5	6BC5/6CE5
6BK4C	6BK4C/6EL4A
6BL8	6BL8/ECF80
6BM8	6BM8/ECL82
6BN6	6BN6/6KS6
6BQ5	6BQ5/EL84
6BQ6GT 6BQ6GTA 6BQ6GTB	6BQ6GTB/6CU6
6BQ7 6BQ7A	6BQ7A/6BZ7
6BX6	6BX6/EF80
6BR3	6RK19/6BR3
6BZ7	6BQ7A/6BZ7
6CA7	6CA7/EL34
6CD3 6CE3	6CE3/6CD3
6CE5	6BC5/6CE5
6CG7	6CG7/6FQ7
6CU6	6BQ6GTB/6CU6
6CW5	6CW5/EL86
6DA4 6DA4A 6DM4 6DM4A	6DA4A/6DM4A
6DQ6 6DQ6A 6DQ6B	6DQ6B/6GW6
6DHH13	6FX7/6DHH13
6DX8	6DX8/ECL84
6DZ4	6DZ4/6AF4A

TUBE TYPE	SYLVANIA DOUBLE/BRAND
6EH7	6EH7/EF183
6EJ7	6EJ7/EF184
6EL4A	6BK4C/6EL4A
6ES8	6ES8/ECC189
6FG6	6FG6/EM84
6FQ5 6FQ5A	6GK5/6FQ5A
6FQ7	6CG7/6FQ7
6FX7	6FX7/6DHH13
6GB3A	6BQ6GTB/6CU6
6GB5	6GB5/EL500
6GB6	6DQ6B/6GW6
6GH8 6GH8A	6EA8/6GH8A
6GJ7	6GJ7/ECF801
6GK5	6GK5/6FQ5A
6GW6	6DQ6B/6GW6
6GW8	6GW8/ECL86
6GX6 6GY6	6GY6/6GX6
6HA5	6HA5/6HM5
6HG8	6HG8/ECF86
6HM5	6HA5/6HM5
6HU6	6HU6/EM87
6HU8	6HU8/ELL80
6JE6C	6JE6C/6LQ6
6JW8	6JW8/ECF802
6K11	6K11/6Q11
6KD8	6U8A/6KD8
6KN8	6RHH8/6KN8
6KS6	6BN6/6KS6
6LH6A 6LJ6 6LJ6A	6LJ6A/6LH6A
6LQ6	6JE6C/6LQ6
6LX8	6LX8/LCF802
6Q11	6K11/6Q11
6RHH8	6RHH8/6KN8
6RK19	6RK19/6BR3

TUBE TYPE	SYLVANIA DOUBLE/BRAND
6U8 6U8A	6U8A/6KD8
6V4	6V4/EZ80
6X9	6X9/ECF200
7HG8	7HG8/PCF86
8CG7 8FQ7	8CG7/8FQ7
8GJ7	8GJ7/PCF801
9A8	9A8/PCF80
10CW5	10CW5/LL86
10DX8	10DX8/LCL84
11Y9	11Y9/LFL200
12AT7	12AT7/ECC81
12AU7 12AU7A	12AU7A/ECC82
12AX7 12AX7A	12AX7A/ECC83
12BQ6GT 12BQ6GTA 12BQ6GTB	12BQ6GTB/12CU6
12BR3	12RK19/12BR3
12C5 12CU5	12C5/12CU5
12CU6	12BQ6GTB/12CU6
12DQ6 12DQ6A 12DQ6B 12GB7 12GW6	12DQ6B/12GW6
12GN7A 12HG7	12GN7A/12HG7
12RK19	12RK19/12BR3
13GB5	13GB5/XL500
13J10 13Z10	13J10/13Z10
15CW5	15CW5/PL84
16A8	16A8/PCL82
16AQ3	16AQ3/XY88
17AX4GT 17AX4GTA	17AX4GTA/17DM4A
17BR3	17BR3/17RK19
17C5 17CU5	17C5/17CU5

TUBE TYPE	SYLVANIA DOUBLE/BRAND
17DM4 17DM4A	17AX4GTA/17DM4A
17DQ6 17DQ6A 17DQ6B	17DQ6B/17GW6
17EW8	17EW8/HCC85
17GW6	17DQ6B/17GW6
17RK19	17BR3/17RK19
25BQ6G 25BQ6GA 25BQ6GT 25BQ6GTB 25CU6	25BQ6GTB/25CU6
27GB5	27GB5/PL500
DY87	1S2A/DY87
EABC80	6AK8/EABC80
ECC81	12AT7/ECC81
ECC82	12AU7A/ECC82
ECC83	12AX7A/ECC83
ECC85	6AQ8/ECC85
ECC189	6ES8/ECC189
ECF80	6BL8/ECF80
ECF86	6HG8/ECL86
ECF200	6X9/ECF200
ECF801	6GJ7/ECF801
ECF802	6JW8/ECF802
ECL80	6AB8/ECL80
ECL82	6BM8/ECL82
ECL84	6DX8/ECL84
ECL86	6GW8/ECL86
EF80	6BX6/EF80
EF93	6BA6/EF93
EF95	6AK5/EF95
EF183	6EH7/EF183
EF184	6EJ7/EF184

TUBE TYPE	SYLVANIA DOUBLE/BRAND
EL34	6CA7/EL34
EL84	6BQ5/EL84
EL86	6CW5/EL86
EL500	6GB5/EL500
ELL80	6HU8/ELL80
EM84	6FG6/EM84
EM87	6HU6/EM87
EY88	6AL3/EY88
EZ80	6V4/EZ80
GZ34	5AR4/GZ34
HCC85	17EW8/HCC85
LCF86	5HG8/LCF86
LCF201	5U9/LCF201
LCF802	6LX8/LCF802
LCL84	10DX8/LCL84
LFL200	11Y9/LFL200
LL86	10CW5/LL86
PC900	4HA5/PC900
PCF80	9A8/PCF80
PCF86	7HG8/PCF86
PCF801	8GJ7/PCF801
PCL82	16A8/PCL82
PL84	15CW5/PL84
PL500	27GB5/PL500
XCF80	4BL8/XCF80
XF183	3EH7/XF183
XF184	3EJ7/XF184
XL500	13GB5/XL500
XY88	16AQ3/XY88

# Foreign - American Receiving Tube Replacement Guide

Foreign Type Number	American Direct Replacement	American Similar Types	Foreign Type Number	American Direct Replacement	American Similar Types
1C1	1R5	—	6F29	6EH7/EF183	—
1C2	1AC6	—	6F30	6EJ7/EF184	—
1C3	1AB6	—	6F31	6BA6/EF93	—
1D13	1A3	—	6F33	6AS6	—
1F1	1AJ4	1T4	6F35	6AJ5	—
1F2	1L4	—	6F36	6AH6	—
1F3	1T4	—	6FD12	6DC8	—
1FDL	1AH5	1S5	6FX4	6AV4	—
1FD9	1S5	—	6G-B3A	6BQ6TB/6CU6	—
1H35	1AB6	—	6G-B9	6DQ6B/6GW6	—
1M1	—	1M3	6G-B6	6BQ6TB/6CU6	6DQ6B/6GW6
1N5VG	—	1N5GT	6G-K17	6AU4GTA	—
1P1	3C4	—	6H31	6BE6	—
1P10	3S4	—	6J6L	—	6J6A
1P11	3V4	—	6J6R	—	6J6A
1R5SF	1AQ5	1R5	6J8EG	—	6J8G
1RK23	1S2	—	6J8GA	—	6J8G
1S5SF	1AR5	1S5	6L10	6AG7	—
1T4SF	1AM4	1T4	6L12	6AQ8/ECC85	—
1U5SF	1AS5	1U5	6L13	12AX7A/ECC83, 7025	12AX7/ECC83
3A4T	—	3A4	6L31	6AQ5A	—
3D-HH13	3FX7/3DHH13	—	6L34	6AQ4	—
3M-R24	3DK6	3CB6	6L43	6CL6	—
3M-V7	3BZ6	—	6LD3	6CV7	—
3S4SF	3W4	3S4	6LD12	6AK8/EABC80	6T8A
4R-HH2	4BQ7A/4BZ7	4BQ7/4BZ7	6LD13	6BD7	—
		4BS8	6LP12	6BM8/ECL82	—
4R-HH8	4RHH8/4KN8	—	6M1	—	6U5
4Y25	807	—	6M2	6CD7	—
5B/250A	807	—	6M-H1	6J4	—
5M-HH3	5J6	—	6M-HH3	6J6A	—
5P-29	6CN6	—	6P9	6BM5	—
5RHP1	4BL8/XCF80	—	6P15	6BQ5/EL84	—
5S1	807	—	6P17	6AM5	—
5Y3GB	—	5Y3GT	6P25	6AG6	—
5Z10	5U4GB	—	6Q8	6A8, G, GT	—
6AT7N	6DT8	—	6R-HH1	—	6DJ8, 6922
6B8EG	—	6B8	6R-HH2	6BZ8	—
6B32	6AL5	—	6R-HH8	6RHH8/6KN8	—
6BC32	6AV6	—	6R-K19	6RK19/6BR3	—
6BS4	—	6DZ4/6AF4A	6Z31	6X4	—
6C12	6AJ8	—	7D9	6AM5	—
6C16	6BL8/ECF80	—	7D10	6CH6	6BQ5/EL84
6C18	6GV7	—	7F16	6CJ5	—
6CC31	6J6A	—	8D3	6AM6	6BA6/EF93
6D1	6DR4	—	8D4	—	6W7
6D2	6AL5	—	8D5	6BR7	5879
6D-HH13	6FX7/6DHH13	—	8D6	6BW7	—
6E8	6A8	—	8D7	6BS7	5879
6F10	6AC7	—	8D8	—	EF86/6267
6F12	6AM6	6BH6	8R-HP1	8B8	—
6F16	6CJ5	—	9BR8	—	9U8A
6F18	6EC7	—	9D6	6CQ6	6BJ6, A
6F19	6BY7	—	9M-HH3	9J6	—
6F21	6CQ6	6BJ6, A	9P9	9BM5	—
6F22	EF86/6267	5879	9R-AL1	6FD7	—
6F23	6EL7	—	10C14	19D8, 19AJ8	—
6F24	—	6EJ7/EF184	10F18	13EC7	—
6F25	—	6EH7/EF183			
6F26	6BY7	—			

## Foreign - American Receiving Tube Replacement Guide (cont'd)

Foreign Type Number	American Direct Replacement	American Similar Types	Foreign Type Number	American Direct Replacement	American Similar Types
10L14	26AQ8	—	66KU	6BT4	—
10LD3	14L7	—	67PT	6CK5	—
10LD12	28AK8	—	77E	—	6C6
10P18	45B5	—	77M	—	6J7, G, GT
10PL12	50BM8	—	80S	—	5Z4, GT
11L6	—	6L6, 6L6GC	85A1	OE3	—
12AU7R	—	12AU7A/ECC82	85A2	OG3	5651, A
12AX7R	—	12AX7/ECC83	85A3	5783	—
		12AX7A/ECC83	86M	—	6P5, GT
		7025	88M	—	6SK7, GT
12BC32	12AV6	—	89RS	—	6B8, G
12F31	12BA6	—	108C1	OB2	—
12G-B3	—	12DQ6B/12GW6	121VP	12AC5	—
12G-B6	12BQ6B/12CU6	—	141DDT	14L7	—
12G-B7	12DQ6B/12GW6	—	141TH	14K7	—
12G-K17	—	12D4, A	150B2	6354	—
12H31	12BE6	—	150C1	OA2	—
12R-K19	12RK19/12BR3	12AF3	150C2	OA2	—
12R-LL3	12AV7	—	150C3	OD3, OD3A	—
13D2	6SN7GTB	—	150C4	—	OA2
15FM7	—	13FM7	163 Pen	16A5	—
17N8	17C8	—	171DDP	17C8	—
17R-HH2	—	17EW8/HCC85		17N8	—
17RK19	17BR3/17RK19	—	213 Pen	21A6	—
19AJ8	19D8	—	311SU	31A3	—
19BD	19X3	—	451PT	45A5	—
19M-R9	18FW6A	—	A676	—	76
19M-R10	18ED6	—	A678	—	78
	18GD6	—	A863	—	6J7, G, GT
19SU	19Y3	—	A1834	6AS7G, GA, GYB	—
19U3	19X3	—		6080	—
19W3	19X3	—	AA91E	5726	—
20D3	12AH8	—		5726/6AL5W	—
20D4	6AJ8	—	AD	6Z3	—
24/76	—	6P5G, GT	AG5209	OG3	5651, A
24/78	—	6K7, GT	AG5210	—	OB2, OB2WA
25G-B6	25BQ6GTB/25CU6	—	AG5211	—	OA2, OA2WA
30C1	9A8/PCF80	9U8A	ASG512	2D21	—
30C15	9EN7	—	B36	12SN7GTA	—
30C18	7GV7	—	B63	6A6	—
30F5	7ED7	—	B65	6SN7GTB	—
30FL1	9GB8	—	B139	7AN7	—
30L1	7AN7	—	B152	12AT7/ECC81	—
30L15	7EK7	—	B309	12AT7/ECC81	—
30P4	25GF6	25BQ6GTB/25CU6	B319	—	7AN7
30P12	12FB5	—	B329	12AU7A/ECC82	—
30P16	16A5	—	B339	12AX7/ECC83	—
30P18	15CW5/PL84	—		7025	—
30P19	25GF6	—	B719	—	6AQ8/ECC85
30PL1	13GC8	—	B739	—	12AT7/ECC81
30PL12	16A8/PCC82	—	B749	—	12AU7A/ECC82
30PL13	16GK8	—	B759	—	12AX7/ECC83,
41E	—	41			7025
41M	—	6K6GT	BF61	6CK5	6CL6
42E	—	42	BF451	45A5	—
52KU	5Z4G	5V4GA	BPMO4	6AQ5A	—
53KU	—	5V4GA	CC81E	12AT7WA	12AT7/ECC81
62DDT	6CV7	—		6201	—
62TH	6CU7	7J7	CCa	6922	—
62VP	6CJ5	—	D1C	957	—
63ME	—	6U5	D2C	958A	—
63T1	6AB8A	6AB8/ECL80	D2M9	6AL5	—
63TP	6AB8/ECL80	—	D3F	959	—
64ME	6CD7	—	D61	—	6CT7
64SPT	6BX6/EF80	—	D63	—	6H6
65ME	6BR5	—	D77	6AL5	—

## Foreign - American Receiving Tube Replacement Guide (cont'd)

Foreign Type Number	American Direct Replacement	American Similar Types	Foreign Type Number	American Direct Replacement	American Similar Types
D152	6AL5	—	DP61	6AK5/EF95	—
D717	—	6AL5	DS77	—	6AL5
DA90	1A3	—	DY30	—	1G3GT/1B3GT
DAC32	1H5GT	—	DY70	5642	—
DAF91	1S5	—	DY80	—	1X2B
DAF92	1U5	—	DY86	1S2	1H2
DAF96	1AH5	1S5	DY87	1S2A/DY87	1H2
DAF191	—	1S5	E1F	954	—
DC70	6375	1E3	E2F	956	—
DC80	1E3	—	E55L	8233	—
DCC90	3A5	—	E80CC	6085	—
DCF60	—	1V6	E80CF	7643	—
DD6	—	6AL5	E80F	6084	—
DD7	6AM5	—	E80L	6227	—
DDR7	6AM5	—	E80T	6218	—
DF33	1N5GT	—	E81CC	12AT7WA	12AT7/ECC81
DF60	5678	—		6201	—
DF62	1AD4	—	E81L	6686	—
DF91	1T4	—	E82CC	6189/12AU7WA	12AU7A
DF92	1L4	—		6201	12AU7/ECC82
DF96	1AJ4	1T4		6189/12AX7A	12AX7A/ECC83
DF97	1AN5	—	E83CC	6181/12AX7A	12AX7/ECC83
DF652	1AD4	—		E83F	6689
DF904	1U4	—		E84L	7320
DH63	6Q7, GT	—		E88CC	6922
DH63M	—	6Q7, GT		E90CC	5920
DH74	12Q7GT	—		E90F	7693
DH76	—	12Q7, GT			68H6
DH77	6AT6	—			6661/6BH6
DH81	—	7B6		E90Z	6X4
DH118	—	14L7		E91AA	5726
DH142	—	14L7			5726/6AL5W
DH147	—	6Q7, GT		E91H	6687
DH149	7C6	—			5727
DH150	6CV7	—		E91N	5727
DH718	6CV7	—		E95F	5654
DH719	6T8A	6AK8/EABC80		E99F	7694
DH817	6CV7	—		E130L	7534
DK32	1A7GT	—		E180CC	7062
DK91	1R5	—		E180F	6688A
DK92	1AC6	—		E182CC	7119
DK96	1AB6	—		E182F	5847/404A
DK97	1AB6	—		E186F	7737
DL29	3D6	—		E188CC	7308
DL31	1A5GT	—		E280F	7722
DL33	3Q5GT	—		E902	6X4
DL35	1C5GT	—		E288CC	8223
DL36	1Q5GT	—		EA52	6923
DL63	—	6R7		EA76	6489
DL67	6007	—		EAA91	6AL5
DL70	6373	—		EAA171	—
DL74M	—	12Q7GT		EAA901	5726
DL82	—	7B6			5726/6AL5W
DL91	1S4	—		EAA901S	5726
DL92	3S4	—			5726/6AL5W
DL93	3A4	—		EABC80	6AK8/EABC80
DL94	3V4	—		EAF42	6CT7
DL95	3Q4	—		EB34	—
DL96	3C4	3V4		EB91	6AL5
DL98	3B4	3B4WA		EBC33	—
DL193	—	3A4			6Q7, GT
DL620	5672	—			6R7
DM70	1M3	—		EBC41	6CV7
DM71	1N3	—		EBC80	6BD7
DM160	6977	—		EBC81	6BD7A
				EBC90	6AT6
				EBC91	6AV6



## Foreign - American Receiving Tube Replacement Guide (cont'd)

Foreign Type Number	American Direct Replacement	American Similar Types	Foreign Type Number	American Direct Replacement	American Similar Types
EBF32	—	6B8	ECH81	6AJ8	—
EBF80	6N8	—	ECH83	6DS8	—
EBF81	6AD8	—	ECH113	6CU7	7J7
EBF83	6DR8	—	ECH171	—	6AJ8
EBF89	6DC8	—	ECH200	6V9	—
EBF171	—	6N8	ECL80	6AB8/ECL80	—
EBF175	—	6DC8	ECL82	6BM8/ECL82	—
EC70	5718	—	ECL83	—	6BM8/ECL82
EC71	5718	—	ECL84	6DX8/ECL84	—
EC80	6Q4	6BC4	ECL85	6GV8	—
EC81	6R4	—	ECL86	6GW8/ECL86	—
EC84	6AJ4	—	ED2	6AL5	—
EC86	6CM4	—	EF5	6DA6	—
EC88	6DL4/EC88	—	EF9	—	6K7, GT
EC90	6C4	—	EF13	6DA6	—
EC91	6AQ4	—	EF22	7G7	7B7
EC92	6AB4	—	—	—	7A7
EC93	6BS4	6DZ4/6AF4A	EF36	6J7, GT	—
EC94	6DZ4/6AF4A	—	EF37, A	—	6J7, GT
EC95	6ER5	6ES5	EF39	—	6K7, G, G7
EC97	6FY5	6GK5/6FQ5A	EF40	—	5879
EC900	6HA5/6HM5	—	EF41	6CJ5	—
EC1000	8254	—	EF42	—	6EW6
ECC32	—	6SN7GTB	EF70	6487	—
ECC33	—	6SN7GTB	EF71	5899	—
ECC35	—	6SL7GT	EF72	5840	—
ECC40	—	6N7, GT	EF73	6488	—
ECC70	6021	—	EF74	6391	—
ECC81	12AT7/ECC81	—	EF80	6BX6/EF80	—
ECC82	12AU7/ECC82	—	EF81	6BH5	—
ECC83	12AX7A/ECC83	—	EF82	6CH6	6BQ5/EL84
—	7025	—	EF83	6BK8	—
ECC84	6CW7	6BQ7A/6BZ7	EF85	6BY7	—
ECC85	6AQ8/ECC85	—	EF86	6267	5879
ECC86	6GM8	—	—	6CF8	—
ECC88	6DJ8	6922	EF89	6DA6	—
ECC89	6FC7	6ES8/ECC189	EF89F	6DG7	—
ECC91	6J6A	—	EF91	6AM6	—
ECC180	6BQ7A/6BZ7	—	EF92	6CQ6	—
ECC186	7316	—	EF93	6BA6/EF93	—
—	12AU7A/ECC82	—	EF94	6AU6A	—
ECC189	6ES8/ECC189	—	EF95	6AK5/EF95	—
ECC230	6080	—	EF96	6AG5	6BC5/6CE5
ECC801	12AT7WA	12AT7/ECC81	EF97	6ES6	—
—	6201	—	EF98	6ET6	—
ECC801S	12AT7WA	12AT7/ECC81	EF98	—	6BX6/EF80
—	6201	—	EF174	—	6BY7
ECC802	6189	12AU7A/ECC82	EF175	—	—
ECC802S	6189	12AU7A/ECC82	EF183	6EH7/EF183	—
ECC803	12AX7A/ECC83	12AX7/ECC83	EF184	6EJ7/EF184	—
—	7025	—	EF190	6CB6A	—
ECC803S	12AX7A/ECC83	12AX7/ECC83	EF730	5636	—
—	7025	—	EF731	5899	—
ECC804	6GA8	—	EF732	5840	—
ECC960	5920	—	EF734	6205	—
ECF80	6BL8/ECF80	—	EF811	—	6EH7/EF183
ECF82	6U8A/6KD8	—	EF812	6EL7	—
ECF86	6HG8/ECF86	—	EF814	—	6EJ7/EF184
ECF200	6X9/ECF200	—	EF861	6688A	—
ECF201	6U9	—	EF905	5654	6AK5/EF95
ECF801	6GJ7/ECF801	—	—	5654/6AK5W	—
ECF802	6JW8/ECF802	—	EFL200	6Y9	—
ECH3G	—	6K8	EH90	6CS6	6BY6
ECH35	—	6E8G, 6K8	EH900	—	5915
ECH42	6CU7, 6C9	7J7	EH900S	—	5915
ECH80	6AN7	—	EK32	—	6A8, G, GT
—	—	—	EK90	6BE6	—

## Foreign - American Receiving Tube Replacement Guide (cont'd)

Foreign Type Number	American Direct Replacement	American Similar Types	Foreign Type Number	American Direct Replacement	American Similar Types
EL32	—	6V6GTA	GZ33	—	5V4GB
EL33	—	6V6, 6V6GTA	GZ34	5AR4/GZ34	5AR4/GZ34
EL34	6CA7/EL34	7027A	H63	6F5, GT	5U4GB
EL35	—	6Y6GA	HAA91	12AL5	—
EL36	6CM5	6Y6G	HABC80	19T8	—
EL37	—	6L6GC	HBC90	12AT6	—
EL38	6CN6	7027A	HBC91	12AV6	—
EL41	6CK5	—	HCC85	17EW8/HCC85	—
EL71	5902	6CL6	HCH81	12AJ7	—
EL80	6M5	—	HD14	1H5G, GT	—
EL81	6CJ6	6BQ5/EL84	HD30	3B4, 3B4WA	—
EL82	6DY5	—	HD51	OA2	—
EL83	6CK6	—	HD52	OB2	—
EL84	6BQ5/EL84	6CL6	HD93	1X2B	—
EL85	6BN5	—	HD94	6BQ6GTB/6CU6	—
EL86	6CW5/EL86	—	HD96	25BQ6GTB/25CU6	—
EL90	6AQ5A	—	HF61	6CJ5	—
EL91	6AM5	—	HF93	12BA6	—
EL95	6DL5	—	HF94	12AU6	—
EL180	12BY7A	—	HF121	12AC5	—
EL360	—	6CM5	HK90	12BE6	—
EL500	6GB5/EL500	—	HL90	19AQ5	—
EL803	—	6CK6	HL92	50C5	—
EL821	6CH6	6BQ5/EL84	HL94	30A5	35C5
EL822	6CH6	6BQ5/EL84	HMO4	6BE6	—
EL861	6686	—	HP6	6AM6	—
ELL80	6HU8/ELL80	—	HY90	35W4	—
EM34	6CD7	—	HZ90	12X4	—
EM80	6BR5	—	KD21	OA3, OA3A	—
EM81	6DA5	—	KD24	OC3, OC3A	—
EM84	6FG6/EM84	—	KD25	OD3, OD3A	—
EM85	6DG7	—	KL35	—	1F5G
EM87	6HU6/EM87	—	KT32	—	25L6GT
EM840	6FG6/EM84	—	KT61	6AG6G	6V6, 6V6GTA
EN32	2050	—	KT63	—	6M6G
EN91	2D21	—	KT66	6F6, G, GT	—
EN92	5696	—	KT71	—	7027A
EN93	6D4	—	KT77	6CA7/EL34	6L6GC
EQ80	6BE7	—	KT81	—	5881
EY51	6X2	—	KTW61	—	807
EY80	6U3	—	KTW63	—	50L6GT
EY81	6R3	6AF3	KTW74M	—	7027A
EY81F	6V3	—	KTZ63	—	7C5
EY82	6N3	—	L63	6C5	6S7
EY83	—	6S2	L63B	6C5	6K7, G, GT
EY84	—	6AL3/EY88	L77	6C5, GT	—
EY86	6S2	6374	LC900	6C5	—
EY87	6S2A	—	LCF80	6J5, GT	—
EY88	6AL3/EY88	—	LCF86	6C4	—
EY500	6EC4	—	LCF86	3HM5/3HA5	—
EZ3	6V4/EZ80	6CA4	LCF200	6LN8	—
EZ4	6CA4	—	LCF201	5HG8/LCF86	—
EZ11	6V4/EZ80	6CA4	LCF801	5X9	—
EZ35	6X5GT	—	LCF802	5U9/LCF201	—
EZ40	6BT4	—	LCH200	5GJ7	—
EZ80	6V4/EZ80	6CA4	LCL84	6LX8/LCF802	—
EZ81	6CA4	—	LCL200	5V9	—
EZ90	6X4	—	LF183	10DX8/LCL84	—
EZ91	6AV4	—	LF184	11Y9/LCL200	—
GZ30	5Z4, GT	—	LFL200	4EH7	—
GZ31	—	5U4GB		4EJ7	—
GZ32	5V4GA	—		11Y9/LFL200	—

Foreign - American Receiving Tube Replacement Guide (cont'd)

Foreign Type Number	American Direct Replacement	American Similar Types	Foreign Type Number	American Direct Replacement	American Similar Types
LL86	10CW5/LL86	—	N709	6BQ5/EL84	—
LN119	50BM8	—	N727	6AQ5A	—
LN152	6AB8/ECL80	—	OBC3	12SQ7, GT	—
LN319	13GC8	—	OF1	—	6S7
LY88	20AQ3	—	OH4	12A8GT	—
LY500	28EC4	—	OM4	—	6Q7, GT
LZ319	8A8	9A8/PCF80	OM6	—	6K7, GT
		9U8A	OM10	—	6K8
LZ329	9A8/PCF80	9U8A	OSW2190	—	6AC7
M8079	5726	6AL5	OSW2192	—	6AG7
M8080	—	6C4	OSW2600	—	6AC7
M8081	6101	6J6A	OSW2601	6AG7	—
	6101/6J6WA	—	OSW3104	—	6SA7, GT
M8082	—	6AM5	OSW3105	—	6SQ7, GT
M8083	—	6AM6	OSW3106	—	6V6, GT
M8096	5763	—	OSW3109	—	6H6
M8098	—	0G3, 5651A	OSW3110	6E5	—
M8100	5654	6AK5/EF95	OSW3111	—	6SK7, GT
	5654/6AK5W	—	OSW3112	—	6J5
M8121	5840	—	P17A	807	—
M8136	6189/12AU7WA	12AU7AECC82	PABC80	9AK8	—
M8137	12AX7A/ECC83	12AX7/ECC83	PC86	4CM4	—
	7025	—	PC95	4GK5	—
M8161	6065	—	PC97	3FY5	—
M8162	12AT7WA	12AT7/ECC81	PC900	4HA5/PC900	—
	6201	—	PCC84	7AN7	—
M8190	—	5783	PCC85	9AQ8	—
M8196	5725	6AS6	PCC88	7DJ8	—
M8204	5727	2D21	PCC89	7FC7	—
M8212	5726	6AL5	PCC189	7ES8	—
M8214	—	12AX7A/ECC83	PCC805	7EK7	—
		12AX7/ECC83	PCE800	9GB8	—
M8223	OA2WA	OA2	PCF80	9A8/PCF80	9U8A
M8224	OB2WA	OB2	PCF82	9U8A	—
M8232	6J4WA	6J4	PCF86	7HG8/PCF86	8HG8
	8532/6J4WA	—	PCF800	9EN7	—
M8245	6005	6AQ5A	PCF801	8GJ7/PCF801	—
N14	1C5GT	—	PCF805	7GV7	—
N15	3Q5GT	—	PCL82	16A8/PCL82	—
N16	3Q5GT	—	PCL84	15DQ8	—
N17	3S4	—	PCL85	18GV8	—
N18	3Q4	—	PCL800	16GK8	—
N19	3V4	—	PF9	—	6K7
N25	3C4	—	PH4	6A8, G, GT	—
N77	—	6AM5	PL21	2D21	—
		6AL5	PL36	25E5	—
N78	6BJ5	—	PL81	21A6	—
N119	45B5	—	PL82	16A5	—
N142	45A5	—	PL83	15A6	—
N144	6AM5	—	PL84	15CW5/PL84	—
N147	6AG6G	—	PL500	27GB5/PL500	—
		6V6	PL820	—	21A6
		6V6GTA	PL1267	0A4G	—
N148	—	7C5	PLL80	12HU8	—
N150	6CK5	6CL6	PM04	6BA6/EF93	—
N152	21A6	—	PM05	—	6AK5/EF95
N153	15A6	—	PM07	6AM6	—
N154	16A5	—	PY80	19X3	—
N155	6BN5	—	PY81	17Z3	—
N308	—	25E5	PY82	19Y3	—
N309	15A6	—	PY83	—	17Z3
N329	16A5	—	PY88	30AE3	—
N359	21A6	—	QA2400	6065	6CQ6
N369	16A8/PCL82	—	QA2401	—	6C4
N379	15CW5/PL84	—	QA2402	—	6AM5
N707	—	6BQ5/EL84	QA2403	—	6AM6

## Foreign - American Receiving Tube Replacement Guide (cont'd)

Foreign Type Number	American Direct Replacement	American Similar Types	Foreign Type Number	American Direct Replacement	American Similar Types
QA2404	—	6AL5	TXM100	—	2D21
QA2406	—	12AT7/ECC81			5727
QA2407	—	6X4, 6X4W	U17	—	1T4
QA2408	5692	6SN7GTB	U26	6S2	—
QB65	—	6SN7GTB	U37	1T2	—
QB309	—	12AT7/ECC81	U41	—	1G3GT/1B3GT
QE03/10	5763	—	U43	6X2	—
QE05/40	6146	—	U49	6S2	—
QE05/40H	6159	—	U50	5Y3GT	—
QE06/50	—	807	U52	5U4G	—
		5933		5U4GB	—
QL77	6C4	—	U70	—	6X5GT
QQE02/5	6939	—	U74	—	35Z4GT
QQE03/12	6360	—	U76	35Z4GT	—
QQE03/20	6252	—	U78	6X4	—
QQV02-6	6939	—	U82	—	7Y4
QQV03-10	6360	—	U119	38A3	—
QS83-3	—	0G3	U142	31A3	—
QS150/40	0D3, 0D3A	—	U145	31A3	—
QS1205	0A3, 0A3A	—	U147	6X5GT	—
QS1206	0C3, 0C3A	—	U149	7Y4	—
QS1207	0A2	—	U150	6BT4	—
QS1208	0B2	—	U151	6X2	—
QS1209	5651A	0G3	U152	19X3	—
QS1210	0A2WA	0A2	U153	17Z3	—
QS1211	0B2WA	0B2	U154	19Y3	—
QS1212	—	0G3	U191	19CS4	—
		5651A	U192	19Y3	—
		5651WA	U193	17Z3	—
QS2404	5726	6AL5	U309	—	19X3
QS2406	12AT7WA	12AT7/ECC81	U319	—	19Y3
		—	U381	38A3	—
QV03-12	5763	—	U404	—	31A3
QV05/25	—	807	U707	6X4	—
QV06/20	6146	—	U709	—	6CA4
R3	1W4	—	UAVC80	28AK8	—
R12	6X2	—	UAF42	12S7	—
R12A	6X2	—	UBC41	14L7	—
R16	1T2	—	UBC80	14G6	—
R17	—	6N3	UBF80	17C8	—
R19	—	1X2B		17N8	—
R52	5Z4, GT	—	UC92	9AB4	—
R144	6AM6	—	UCC85	26AQ8	—
REL39	—	6AC7	UCH42	14K7	—
RL21	2D21	—	UCH80	14Y7	—
RL1267	0A4G	—	UCH81	19D8	—
RS1029	6360	—		19AJ8	—
S6F12	6AM6	—	UCL82	50BM8	—
S856	0A2	—	UF6A7	—	6A7
S860	0B2	—	UF41	12AC5	—
SM150-30	0A2	—	UF89	12AD6	—
SP6	6AM6	—	UL41	45A5	—
SR2	0G3	5651A	UL84	45B5	—
SR3	0B2	—	UQ80	12BE7	—
STR85/10	0G3	5651A	UU9	6BT4	—
STR108/30	0B2	—	UU12	6CA4	—
STR150/30	0A2	—	UY24B	—	24A
STV85/10	0G3	5651A	UY27	—	27
STV108/30	0B2	—	UY27A	—	27
STV150/30	0A2	—	UY35B	—	35
SU61	6X2	—	UY36	—	36
T2M05	6J6A	—	UY36A	—	36
TM12	—	6J4	UY37	—	37
TS51	—	6AK5/EF95	UY37A	—	37
		5654	UY41	31A3	—
			UY47	—	47

Foreign - American Receiving Tube Replacement Guide (cont'd)

Foreign Type Number	American Direct Replacement	American Similar Types	Foreign Type Number	American Direct Replacement	American Similar Types
UY76	—	76	X727	6BE6	—
UY82	55N3	—	XC95	2ER5	—
UY85	38A3	—	XC97	2FY5	—
UY224	—	24A	XCC82	7AU7	—
V2M70	6X4	—	XCC189	4ES8	—
V61	6BT4	—	XCF80	4BL8/XCF80	—
V177	6CQ6	—	XCH81	3AJ8	—
V311	—	31A3	XCL82	8B8	—
V741	6C4	—	XCL85	9GV8	—
V884	6CQ6	6BJ6, A	XF80	3BX6	—
V886	6AM5	—	XF85	3BY7	—
VP6	6CQ6	6BJ6, A	XF86	2HR8	—
VP12D	12C8	—	XF183	3EH7/XF183	—
W17	1T4	—	XF184	3EJ7/XF184	—
W25	1AJ4	1T4	XFR1	—	1AD4
W61	—	6K7, GT	XFR2	—	5678
W63	—	6K7, GT	XFR5	—	5678
W76	—	12K7GT	XFY14	—	5672
W77	6CQ6	6BJ6, A	XFY15	—	5672
W81	—	7H7	XL36	13CM5	—
W142	12AC5	—	XL84	8BQ5	—
W143	—	7B7	XL86	8CW5	—
W147	—	6K7, GT	—	8CW5A	—
W148	—	7H7	XL500	13GB5/XL500	—
W149	7B7	—	XY88	16AQ3/XY88	—
W150	6CJ5	—	Y25	1N3	—
W179	6BY7	—	Y61	—	6U5
W27	6BA6/EF93	—	Y63	—	6U5
W29	—	6BY7	YC95	3ER5	—
W739	6EC7	6DA6	YC97	3FY5	—
WD142	12S7	—	YCC189	5ES8	—
WD150	6CT7	—	YF183	4EH7	—
WD709	6N8	—	YF184	4EJ7	—
WT294	0D3	—	YL1370	6146B/8298A	6146
X14	1A7GT	—	YL1371	6883	—
X17	1R5	—	—	8032	—
X18	1AC6	—	—	8552	—
X20	1AC6	—	YL1372	6159B	—
X25	1AB6	—	Z14	1N5GT	—
X63 (M)	—	6A8, G, GT	Z63	6J7, G, GT	—
X64	—	6L7	Z77	6AM6	—
X77	6BE6	—	Z152	6BX6/EF80	—
X79	6AE8	—	Z300T	0A4G	—
X81	—	7S7	Z329	—	6BX6/EF80
X119	19D8	—	Z719	6BX6/EF80	—
X142	14K7	—	Z729	6267	5879
X144	—	1A7GT	—	6CF8	—
X147	6E8G	6K8	Z900T	5823	—
X148	7S7	—	ZD17	1S5	—
X150	—	6CU7	ZD25	1AH5	1S5
X155	6BZ8	—	ZD152	6N8	—
X719	6AJ8	—			

# Industrial Receiving Tube Replacement Guides

## BROADCAST EQUIPMENT

Original Type	SYLVANIA REPLACEMENTS		Original Type	SYLVANIA REPLACEMENTS	
	Premium <sup>(1)</sup>	Standard		Premium <sup>(1)</sup>	Standard
0A2	GB-0A2WA	0A2	6BZ6	—	6BZ6
0B2	GB-0B2WA	0B2	6BZ7	—	6BQ7A/6BZ7
0B3	—	0B3	6C4; EC90	GB-6135	6C4
0C3	—	0C3	6CB6	6676/6CB6A <sup>(3)</sup>	6CB6A
0D3	—	0D3	6CD6G	—	6CD6GA
1B3/1G3GT	—	1G3GT/1B3GT	6CG7	—	6CG7/6FQ7
1X2B	—	1X2B	6CG8	—	6CG8A
2C51	GB-5670	2C51	6CL6	6677/6CL6 <sup>(4)</sup>	6CL6
2D21	GB-5727	2D21	6CS6	—	6CS6
2X2A	—	2X2A	6CU8	—	6CU8
5R4	—	5R4GYB	6CX8	—	6CX8
5U4	GB-5931	5U4GB	6CY5	GB-6CY5	6CY5
5V4	—	5V4GA	6DJ8	GB-6DJ8	6DJ8
5Y3GT	GB-5Y3WGTA	5Y3GT	6DQ6	—	6DQ6/6GW6
6AF4	—	6DZ4/6AF4A	6EA8	—	6EA8/6GH8A
6AG5	GB-6186	6AG5	6EH7; EF183	—	6EH7/EF183
6AG7	—	6AG7	6EJ7; EF184	—	6EJ7/EF184
6AK5; EL90	GB-5654	6AK5/EF95	6ER5; EC95	—	6ER5
6AL5; EB91	GB-5726	6AL5	6EU7	—	6EU7
6AN4	—	6AN4	6EV5	—	6EV5
6AN5	—	6AN5	6GK5	—	6GK5/6FQ5A
6AN8	—	6AN8A	6HG8; ECF86	—	6HG8/ECF86
6AQ5	GB-6005	6AQ5A	6J4	GB-6J4WA	6J4
6AS5	—	6AS5	6J6; ECC91	GB-6101	6J6A
6AS6	GB-5725	6AS6	6J7	—	6J7
6AS7G	GB-6080	6AS7GA	6L6	GB-5932	6L6
6AS8	—	6AS8	6SL7GT	GB-6SL7WGT	6SL7GT
6AT6; EBC90	—	6AT6	6SN7GT	GB-6SN7WGT	6SN7GTB
6AU4	—	6AU4GTA	6T8	—	6T8A
6AU6; EF94	GB-6136; 7543 <sup>(2)</sup>	6AU6A	6U8, A	GB-1252/6U8A	6U8A/6KD8
6AU8	—	6AU8A	6V6	—	6V6
6AV6; EBC91	—	6AV6	6W6GT	—	6W6GT
6AW8	—	6AW8A	6X4	GB-6X4WA	6X4
6AX4	—	6AX4GTB	6X5GT	GB-6X5WGT	6X5GT
6AX5GT	—	6AX5GT	6X8	—	6X8
6BA6	GB-5749	6BA6/EF93	6Y6G	—	6Y6GA
6BC5	—	6BC5/6CE5	12AT7; ECC81	GB-6201	12AT7/ECC81
6BE6; EK90	GB-5750	6BE6	12AU7; ECC82	GB-5814A	12AU7A/ECC82
6BG6G	—	6BG6GA	12AV6; HBC91	—	12AV6
6BH6	6661/6BH6 <sup>(3)</sup>	6BH6	12AX7; ECC83	GB-5751	12AX7A/ECC83
6BJ6	6662/6BJ6 <sup>(3)</sup>	6BJ6	12BH7	—	12BH7A
6BJ7	—	6BJ7	12BY7	—	12BY7A
6BK7A	—	6BK7B	407A	GB-407A	—
6BL7GT	—	6BL7GTA	408A	GB-408A	—
6BL8; ECF80	—	6BL8/ECF80	807	GB-5933	807
6BN4	—	6BN4A	1218	—	1218A
6BQ5; EL84	—	6BQ5/EL84	5651	—	5651
6BQ6	—	6BQ6GTB/6CU6	5654	GB-5654	5654
6BQ7A	GB-6BQ7A	6BQ7A/6BZ7	5670	GB-5670	5670
6BS8	—	6BS8	5687	GB-5687	—

### BROADCAST EQUIPMENT (cont'd)

Original Type	SYLVANIA REPLACEMENTS	
	Premium <sup>(1)</sup>	Standard
5693	—	5693
5725	GB-5725	5725
5726	GB-5726	5726
5749	GB-5749	5749
5763	—	5763
5814A	GB-5814A	5814A
5881	—	5881
6005/6AQ5	GB-6005	6005
6028	GB-408A	6028
6146, A	—	6146B/8298A
6201	GB-6201	—
6883	—	6883A

Original Type	SYLVANIA REPLACEMENTS	
	Premium <sup>(1)</sup>	Standard
6922; ECC88	7308	6922
6939	—	6939
7025	—	7025 <sup>(2)</sup>

**Notes:**

- (1) GB prefix—Sylvania GB Gold Brand Type—designed and manufactured for critical industrial and commercial applications.
- (2) Controlled for low hum.
- (3) Application tailored for rugged mobile service—features special heater controls.

### COMMERCIAL AVIATION

Original Type	Standard Industrial	Premium Gold Brand
0A2	0A2WA	GB-0A2WA
0B2	0B2WA	GB-0B2WA
2D21, W	5727/2D21W	GB-5727
6AL5, W	5726	GB-5726
6AQ5, W	6005	GB-6005
6AS7G, GA	6080	GB-6080
6AU6	—	GB-6136
6SN7, GT	6SN7WGTA	GB-6SN7WGT
12AT7	—	GB-6201
12AU7, A	6189	GB-6189
	*5814A	*GB-5814A
5654	5654	GB-5654
5670	5070WA	GB-5670
		**GB-1219/5670

Original Type	Standard Industrial	Premium Gold Brand
5687	5687WA	GB-5687
5725	5725	GB-5725
5749	5749	GB-5749
5750	5750	GB-5750
5751	5751	GB-5751
6146, A, B	6146B/8298A	—
6159, A	6159A	—

**Notes:**

- \*Heater current is 15% higher than original 12AU7, A.
- \*\*Recommended replacement for original Type 5670 when GM at lower heater voltage is critical.

### GENERAL AVIATION

Original Type	Application Tailored*
6AL5	6663/6AL5
6AQ5	6669/6AQ5A
6BA6	6660/6BA6
6BH6	6661/6BH6
6BJ6	6662/6BJ6
6CB6	6676/6CB6A
6U8, A	6678 6U8A
12AB5	7061
12AL5	7055
12AT7	6679/12AT7

Original Type	Application Tailored*
12AU7, A	6680/12AU7A
12AX7	6681/12AX7, **7058
12BY7A	7054

**Notes:**

- \*Designed to operate over wide heater excursions.
- \*\*13.5 volt heater rating instead of 12 volt nominal for 6681/12AX7.

## MOBILE COMMUNICATIONS

Sylvania Mobile Type	Prototype	Description
6146A, 6146B/8298A	6146	Beam pentode af/rf power amplifier
6660/6BA6	6BA6	Pentode rf/lf amplifier
6661/6BH6	6BH6	Pentode rf/lf amplifier
6662/6BJ6	6BJ6	Pentode rf/lf amplifier
6663/6AL5	6AL5	Duodiode Detector
6664/6AB4	6AB4	Triode rf amplifier
6669/6AQ5A	6AQ5A	Beam pentode audio power amplifier
6676/6CB6A	6CB6A	Pentode vhf amplifier
6677/6CL6	6CL6	Pentode rf power amplifier
6678/6U8A	6U8A	Triode pentode vhf oscillator/mixer
6679/12AT7	12AT7	Duotriode vhf oscillator/amplifier
6680/12AU7A	12AU7A	Duotriode amplifier/oscillator
6681/12AX7	12AX7	Duotriode af amplifier
6883A	6883	Beam pentode af/rf power amplifier (12-volt battery version of 6146A)
7054	12BY7	Pentode power amplifier
7055	12AL5	Duodiode Detector
7056	—	Pentode vhf amplifier (12-volt battery version of 6676/6CL6)
7057	—	Duotriode vhf amplifier (12-volt battery version of 6BZ7)
7058	12AX7	Duotriode af amplifier
7059	—	Triode pentode vhf oscillator/mixer
7060	—	Triode pentode vhf oscillator/mixer (12-volt battery version of 6AU8)
7061	12AB5	Beam pentode amplifier
7167	—	Tetrode vhf amplifier (12-volt battery version of 6CY5)
7258	—	Triode pentode vhf amplifier (12-volt battery version of 6AN8)
7551	—	Beam pentode amplifier (12-volt battery version of 7558)



# TV PICTURE TUBES

	Page
Color Picture Tube Data .....	504
Color Check Tubes .....	506
Color Picture Tube Basings .....	506
Monochrome Picture Tube Data .....	508
Monochrome Check Tubes .....	532
Notes .....	533
Monochrome Picture Tube Basings .....	535
<b>Replacement Guides</b>	
Color Picture Tubes .....	538
Monochrome Picture Tubes .....	539
Replacement Notes .....	544
<b>Installation and Handling of TV Picture Tubes and Large Cathode Ray Tubes .....</b>	
	<b>545</b>

## X-RAY WARNING:

X-Ray radiation shielding may be necessary to protect against possible danger of personal injury from prolonged exposure at close range if a picture tube is operated at higher than the manufacturer's Maximum Rated Anode Voltage or in any case when operated at higher than 16,000 volts.

Precautions must be exercised during the servicing of equipment to assure that all shielding components are replaced to their intended positions before the equipment is operated.

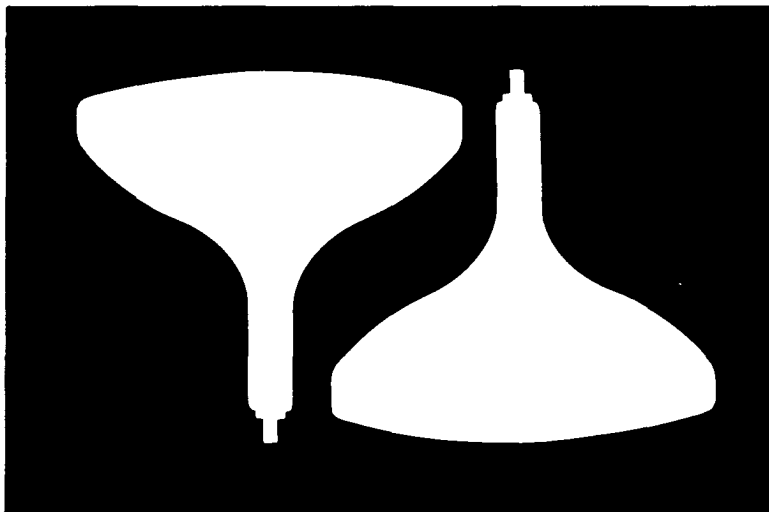

## Color TV Picture Tubes Data

Type	Defl. Angle and Neck Dia. $\Delta$	FACEPLATE		OVERALL DIMENSIONS INCHES		External Coating Capacitance (pf)	Base	Basing	Heater A Volts/Amps	DESIGN MAXIMUM	
		Clear Tinted Alum. Shield* Anti-Ref.	Faceplate Dimensions	Length	Anode (Kv)					Convergence Electrode (Kv) $\Delta$	
11SP22	72	TA	9.88 x 8.13	14.92	600-800	B12-249	14BJ	13.8/58	18	Magnetic	
11WP22	72	TA-FW	9.87 x 8.12	14.91	600-800	B12-249	14BJ	13.8/58	18	Magnetic	
12DCP22	90	TA-TB	10.98 x 8.89	13.97	500-900	B12-246	14BH	6.3/90	20	Magnetic	
13GP22	90	TA-BF	11.81 x 9.70	13.59	500-1000	B12-246	14BH	6.3/90	20	Magnetic	
14BCP22	70	CA	13.06 x 10.56	19.28	500-1500	B12-131	14AU	6.3/1.8	22	Magnetic	
15GP22	45	CA	14.62	26.12	1500-3000	B14-130	20A	6.3/1.8	22	12.1	
15HP22	45	CA	14.62	26.12	1500-3000	B14-130	20A	6.3/1.8	22	12.1	
15KP22	90	TA	12.90 x 10.39	15.0	550-1050	B12-244	14BH	6.3/90	22.5	Magnetic	
15LP22	90	TA-AR-BP	12.90 x 10.39	15.19	550-1050	B12-244	14BH	6.3/90	22.5	Magnetic	
15MP22	90	TA-AR-BP	12.90 x 10.39	15.83	750-1200	B12-244	14BK	6.3/1.35	24.0	Magnetic	
15NP22	90	TA	12.96 x 10.65	15.00	550-1050	B12-244	14BH	6.3/90	22.5	Magnetic	
15RP22	90	TA	12.90 x 10.39	14.72	550-1050	B12-246	14BH	6.3/90	22.5	Magnetic	
15SP22	90	TA-BF	13.53 x 11.02	14.72	550-1050	B12-246	14BH	6.3/90	22.5	Magnetic	
15WP22	90	TA-BP	12.90 x 10.39	14.72	550-1050	B12-246	14BH	6.3/90	22.5	Magnetic	
16CDP22	90	A	13.70 x 11.09	15.12	500-1000	B12-246	14BE	6.3/90	20	Magnetic	
16SP22	90	TA-BP	13.81 x 11.21	15.12	700-1300	B12-246	14BE	6.3/80	23	Magnetic	
16CP22	90	TA-BR	13.81 x 11.22	15.70	700-1300	B12-246	14BH	6.3/90	23	Magnetic	
16DP22	90	TA-BR	13.81 x 11.22	15.12	700-1300	B12-246	14BE	6.3/90	23	Magnetic	
17JP22	70	TA-BP	15.39 x 12.28	21.62	1000-2000	B12-131	14AU	6.3/1.8	22	Magnetic	
17ENP22	70	TA-AR-BP	15.39 x 12.28	21.62	1000-2000	B12-131	14AU	6.3/1.8	22	Magnetic	
19EXP22	90	TA	16.87 x 13.34	17.85	1500-2100	B12-244	14BE	6.3/90	27.5	Magnetic	
19EYP22	90	TA-AR-BP	16.85 x 13.65	18.04	1500-2100	B12-244	14BE	6.3/90	27.5	Magnetic	
19FMP22	90	TA-BP	16.87 x 13.65	18.04	1500-2000	B12-244	14BE	6.3/80	27.5	Magnetic	
19FXP22	90	TA-AR-BP	16.96 x 13.65	18.04	1500-2000	B12-244	14BE	6.3/1.35	27.5	Magnetic	
19GSP22	90	TA-BP-AR	16.97 x 13.66	18.06	1500-2000	B12-245	14BE	6.3/1.35	27.5	Magnetic	
19GV22	90	TA	16.97 x 13.66	17.85	1400-1900	B12-244	14BE	6.3/90	27.5	Magnetic	
19GW22	90	TA-AR-BP	16.97 x 13.66	18.04	1400-1900	B12-244	14BE	6.3/90	27.5	Magnetic	
19GY22	90	TA	17.08 x 13.78	17.52	1000-2000	B12-246	14BE	6.3/90	25.5	Magnetic	
19HB22	90	TA-BP	16.97 x 13.66	18.04	1400-1900	B12-244	14BE	6.3/90	27.5	Magnetic	
19HCP22	90	TA-BR	17.10 x 13.91	17.85	1500-2100	B12-244	14BE	6.3/90	27.5	Magnetic	
19HNP22	90	TA-BR	17.10 x 13.91	17.85	1500-2100	B12-244	14BA	6.3/90	22.5	Magnetic	
19HP22	90	TA	16.97 x 13.66	17.57	1400-1900	B12-246	14BE	6.3/90	27.5	Magnetic	
19HRP22	90	TA-AR-BP	16.97 x 13.66	17.77	1400-1900	B12-246	14BE	6.3/90	27.5	Magnetic	
19HX22	90	TA-BR	17.10 x 14.01	17.87	1500-2000	B12-245	14BE	6.3/1.35	27.5	Magnetic	
19HY22	90	TA-BR	17.10 x 13.91	17.85	1500-2100	B12-244	14BH	6.3/90	22.5	Magnetic	
19TP22	60	TA	19.31	24.75	1500-3000	B14-130	20A	6.3/1.8	24.2	13.2	
19VP22	62	TA	19.31	26.43	1500-3000	B12-105	14W	6.3/1.8	29.7	Magnetic	
21AXP22	70	TA	20.56	25.31	.....	B12-131	14W	6.3/1.8	27.5	Magnetic	
21AXP22A	70	TA	20.56	24.93	.....	B12-131	14AH	6.3/1.8	27.5	Magnetic	
21CYP22	70	TA	20.81	25.03	2000-2500	B12-131	14AL	6.3/1.8	27.5	Magnetic	
21CYP22A	70	TA	20.81	25.03	2000-2500	B12-131	14AL	6.3/1.6	27.5	Magnetic	
21FBP22	70	TA	20.81	25.03	2000-2500	B12-131	14AU	6.3/1.8	27.5	Magnetic	
21FBP22A	70	TA	20.81	25.03	2000-2500	B12-131	14AU	6.3/1.8	27.5	Magnetic	
21FJP22	70	TA-AR-BP	21.0	25.28	2000-2500	B12-131	14AU	6.3/1.8	27.5	Magnetic	
21FJP22A	70	TA-BP	21.0	25.21	2000-2500	B12-131	14AU	6.3/1.8	27.5	Magnetic	
21FKP22	70	TA-BP	21.0	25.21	2000-2500	B12-131	14AU	6.3/1.8	27.5	Magnetic	
21GFP22	90	TA-AR-BP	18.81 x 15.13	19.45	1500-2000	B12-245	14BE	6.3/1.35	27.5	Magnetic	
21GLP22	90	TA-BP-AR	18.81 x 15.56	19.45	1500-2000	B12-244	14BE	6.3/1.35	27.5	Magnetic	
21GUP22	70	TA	20.81	25.03	2000-2500	B12-131	14AU	6.3/1.9	27.5	Magnetic	
21GVP22	70	TA-AR-BP	21.0	25.21	2000-2500	B12-131	14AU	6.3/1.9	27.5	Magnetic	
21GW22	90	TA-AR-BP	18.81 x 15.13	19.45	1500-2000	B12-245	14BE	6.3/1.35	27.5	Magnetic	
21GYP22	70	TA-BP	21.0	25.21	2000-2500	B12-131	14AU	6.3/1.9	27.5	Magnetic	
22EP22	70	TA	21.65 x 17.56	25.75	1500-2800	B12-131	14W	6.3/1.8	27.5	Magnetic	
22JP22	90	TA-AR-BP	18.95 x 15.23	19.20	1700-2200	B12-244	14BE	6.3/80	27.5	Magnetic	
22KP22	90	TA	18.95 x 15.23	19.01	1700-2200	B12-244	14BE	6.3/80	27.5	Magnetic	
22LP22	90	TA-BP	18.95 x 15.23	19.20	1700-2200	B12-244	14BE	6.3/80	27.5	Magnetic	
22QP22	90	TA-AR-BP	18.97 x 15.23	19.42	1700-2200	B12-244	14BE	6.3/0.9	27.5	Magnetic	
22RP22	90	TA	18.97 x 15.23	19.23	1700-2200	B12-244	14BE	6.3/1.35	27.5	Magnetic	
22SP22	90	TA-AR-BP	18.97 x 15.23	19.20	2000-2500	B12-244	14BE	6.3/1.35	27.5	Magnetic	
22UP22	90	TA-BR	19.11 x 15.52	19.01	2000-2500	B12-244	14BE	6.3/90	27.5	Magnetic	
23EGP22	92	TA-BP	20.50 x 16.50	19.48	2000-2500	B12-245	14BE	6.3/1.35	27.5	Magnetic	

RATINGS		TYPICAL OPERATION					REMARKS	Type
Focusing Electrode (Kv)	Screen Grid (G2) Volts	Anode (Kv)	Convergence Electrode (Kv) Δ	Focus Electrode (Kv)	Screen Grid (G2) Volts	Neg. Grid #1 or Positive Cathode Voltage for Raster Cutoff		
-50 to +1.0	1000	15	Magnetic	-.25 to .50	200	30-50	In Line Gun	11SP22
-50 to +1.0	700	15	Magnetic	-.25 to .50	350	40-70		11WP22
-55 to +1.1	1000	16	Magnetic	-.075 to .40	390	61-110	Blue Gun Down	12DCP22
-55 to +1.1	1000	18	Magnetic	-.075 to .40	150-390	57-125		13GP22
-55 to +1.1	650	16	Magnetic	2.4 to 3.4	200	45-100		14BCP22
5.5	550	20		8.5 to 10.2	200	45-100		15GP22
					140-315	70		
5.5	550	20	9.3	3.1	200	45-100	Blue Gun Down	15HP22
-55 to +1.1	1000	20	Magnetic	-.075 to .400	150-390	57-125		15KP22
-55 to +1.1	1000	20	Magnetic	-.075 to .400	150-390	57-125	Blue Gun Down	15LP22
5.2	1000	20	Magnetic	3.3 to 4.3	300	50-80	In Line Gun	15MP22
-55 to +1.1	1000	20	Magnetic	-.075 to .400	150-390	57-125		Blue Gun Down
-55 to +1.1	1000	20	Magnetic	-.075 to .40	150-390	57-125	Blue Gun Down	15RP22
-55 to +1.1	1000	20	Magnetic	-.075 to .40	150-390	57-125	Blue Gun Down	15SP22
-55 to +1.1	1000	20	Magnetic	-.075 to .40	150-390	57-125	Blue Gun Down	15WP22
4.8	650	18	Magnetic	3.0 to 3.6	200	45-100	Blue Gun Down	16CDP22
4.8	650	16	Magnetic	2.5 to 3.2	200	45-100		16CSP22
1.1	1000	20	Magnetic	-.075 to 4.0	125-370	60-135		16GP22
4.8	650	20	Magnetic	3.36 to 4.00	200	50-110		16DAP22
5.3	650	18	Magnetic	2.7 to 3.8	200	45-100		17EJP22
5.3	650	18	Magnetic	2.7 to 3.8	200	45-100		17ENP22
6.0	1000	25	Magnetic	4.2 to 5.0	400	90-190		19EX22
6.0	1000	25	Magnetic	4.2 to 5.0	400	90-190	19EY22	
6.0	1000	25	Magnetic	4.2 to 5.0	400	90-190	19FM22	
6.0	1000	25	Magnetic	4.2 to 5.0	400	90-190	19FX22	
6.0	1000	25	Magnetic	4.2 to 5.0	175-460	100		19GSP22
6.0	1000	25	Magnetic	4.2 to 5.0	285-685	95-190		19GVP22
6.0	1000	25	Magnetic	4.2 to 5.0	285-685	95-190		19GWP22
5.5	1000	23	Magnetic	3.8 to 4.6	130-300	50-105		19GPY22
6.0	1000	25	Magnetic	4.2 to 5.0	285-685	95-190		19HBP22
6.0	1000	25	Magnetic	4.2 to 5.0	285-685	95-190		19HC22
6.0	1000	25	Magnetic	4.2 to 5.0	150-390	57-125		19HN22
-55 to +1.1	1000	20	Magnetic	-.075 to .40	150-390	57-125	19HQ22	
6.0	1000	25	Magnetic	4.2 to 5.0	285-685	95-190	19HR22	
6.0	1000	25	Magnetic	4.2 to 5.0	285-685	95-190	19HX22	
-55 to +1.1	1000	20	Magnetic	-.075 to .40	150-390	57-125	Blue Gun Down	19HPY22
4.4	550	20	Magnetic	1.95 to 3.25	200	42-78		19VP22
9.9	550	25	Magnetic	6.5 to 8.0	200	45-100		
6.6	660	25	Magnetic	3.8 to 5.3	150-330	75	Metal Bulb	21AX22
					200	45-100		
6.6	660	25	Magnetic	3.8 to 5.3	130-370	70	Metal Bulb	21AXP22A
6.6	660	25	Magnetic	4.2 to 5.0	200	45-100		21CYP22
6.6	660	25	Magnetic	4.2 to 5.0	130-370	70		21CYP22A
6.0	650	25	Magnetic	1.2 to 5.0	200	45-100		21FBP22
6.0	1000	25	Magnetic	4.2 to 5.0	400	90-190		21FBP22A
6.0	650	25	Magnetic	1.2 to 5.0	200	45-100	21FJP22	
6.0	1000	25	Magnetic	4.2 to 5.0	400	90-190	21FJP22A	
6.0	1000	25	Magnetic	1.2 to 5.0	200	45-100	21FKP22	
					130-370	70		
6.0	1000	25	Magnetic	4.12 to 5.00	300-600	150		21GFP22
6.0	1000	25	Magnetic	4.2 to 5.4	400	60-125	Blue Gun Down	21GLP22
6.0	1000	25	Magnetic	4.3 to 4.7	400	90-190		21GUP22
6.0	1000	25	Magnetic	4.2 to 5.00	400	90-190	Blue Gun Down	21GVP22
6.0	1000	25	Magnetic	4.3 to 4.7	300-600	150	Blue Gun Down	21GWP22
6.0	1000	25	Magnetic	4.2 to 5.0	400	90-190	Blue Gun Down	21GYP22
6.6	880	25	Magnetic	4.0 to 5.1	200	55-105		22EP22
					50-225	60		
6.0	1000	25	Magnetic	4.2 to 5.0	400	90-190	Blue Gun Down	22JP22
6.0	1000	25	Magnetic	4.2 to 5.0	400	90-190		22KP22
6.0	1000	25	Magnetic	4.2 to 5.0	400	90-190	Blue Gun Down	22LP22
6.0	1000	25	Magnetic	4.2 to 5.0	280-560	150		22QP22
6.0	1000	25	Magnetic	4.4 to 4.8	280-560	150		22RP22
6.0	1000	25	Magnetic	4.4 to 4.8	300-660	150	22SP22	
6.0	1000	25	Magnetic	4.2 to 5.0	400	95-190	22UP22	
6.0	650	25	Magnetic	4.2 to 5.4	400	60-125	23EGP22	

## Color TV Picture Tubes Data (cont'd)

Type	Defl. Angle and Neck Dia. x	FACEPLATE Clear Tinted Alum. Shield * Anti-Refli.	OVERALL DIMENSIONS INCHES		External Conductive Coating Capacitance (pf)	Base	Basing	Heater A Volts/Amps	DESIGN MAXIMUM	
			Faceplate Dimensions	Length					Anode (Kv)	Convergence Electrode (Kv) Δ
23EGP22A	92	TA-BP	20.50 x 16.50	19.48	1800-2500	B12-245	14BE	6.3/1.35	27.5	Magnetic
25AP22	90	TA-AR-BP	21.50 x 17.26	20.92	2000-2500	B12-244	14BE	6.3/1.35	27.5	Magnetic
25AP22A	90	TA-AR-BP	21.50 x 17.26	20.92	2000-2500	B12-244	14BE	6.3/1.35	27.5	Magnetic
25ABP22	90	TA-BP	21.50 x 17.26	20.92	2000-2500	B12-244	14BE	6.3/1.35	27.5	Magnetic
25AEP22	90	TA	21.50 x 17.26	20.96	2000-2500	B12-245	14BE	6.3/1.35	27.5	Magnetic
25AFP22	90	TA-AR-BP	21.50 x 17.26	21.16	2000-2500	B12-245	14BE	6.3/1.35	27.5	Magnetic
25AJP22	90	TA-BR	21.64 x 17.55	20.70	2000-2500	B12-244	14BE	6.3/1.35	27.5	Magnetic
25AKP22	90	TA-BF	22.24 x 18.00	20.96	2000-2500	B12-245	14BE	6.3/1.35	27.5	Magnetic
25ALP22	90	TA-BF	21.89 x 17.74	20.73	2000-2500	B12-244	14BE	6.3/1.35	27.5	Magnetic
25ANP22	90	TA-TB	21.50 x 17.26	20.73	2000-2500	B12-244	14BE	6.3/1.35	27.5	Magnetic
25AQP22	90	TA-AR-BR	21.50 x 17.26	20.92	2000-2500	B12-245	14BE	6.3/1.35	27.5	Magnetic
25AWP22	90	TA-BR	21.64 x 17.62	20.72	2000-2500	B12-245	14BE	6.3/1.35	27.5	Magnetic
25AYP22	90	TA-BR	21.64 x 17.55	20.82	2000-2500	B12-244	14BE	6.3/1.35	27.5	Magnetic
25AZP22	90	TA-AR	21.64 x 17.55	20.70	2000-2500	B12-244	14BE	6.3/1.35	27.5	Magnetic
25BP22	90	TA	21.50 x 17.26	20.73	2000-2500	B12-244	14BE	6.3/1.35	27.5	Magnetic
25BP22A	90	TA	21.50 x 17.26	20.73	2000-2500	B12-244	14BE	6.3/1.35	27.5	Magnetic
25CP22	90	TA-BP	21.50 x 17.26	20.92	2000-2500	B12-244	14BE	6.3/1.35	27.5	Magnetic
25FP22	90	TA	21.50 x 17.26	20.92	2000-2500	B12-244	14BE	6.3/1.35	27.5	Magnetic
25GP22	90	TA-AR-BP	21.50 x 17.26	20.12	2000-2500	B12-244	14BE	6.3/1.35	27.5	Magnetic
25WP22	90	TA-AR-BP	21.50 x 17.26	20.92	2000-2500	B12-244	14BE	6.3/1.35	27.5	Magnetic
25XP22	90	TA-AR-BP	21.50 x 17.26	20.92	2000-2500	B12-244	14BE	6.3/1.35	27.5	Magnetic
25YP22	90	TA	21.50 x 17.26	20.73	2000-2500	B12-244	14BE	6.3/1.35	27.5	Magnetic
25ZP22	90	TA-AR-BP	21.50 x 17.26	21.16	2000-2500	B12-245	14BE	6.3/1.35	27.5	Magnetic

Notes—Page 533

Basings—Page 506

## Color Check Tubes

Type	Heater	Face	Body		Basing	Defl. Angle	Anode Volts ● KV Max.	Nominal Length (in.)
	Ef/If Volts Amps		Metal or Glass	External Coating Capacitance (pf)				
TT19	6.3/1.80	□	G	1500/2000	14BE	90	27.5	21.625
TT19B	6.3/1.90	□	G	1500/2100	14BE	90	27.5	18.048
TT21	6.3/1.8	○	G	2000/2500	14AU	70	27.5	25.031

These tubes are electrically equivalent to 19", 90° rectangular and 21", 70° round color picture tubes used by all major manufacturers. They can be adapted to check all popular color picture tubes. Additional technical

information on these tubes and on their application in TV receiver servicing is available on request.

## Basing Diagrams (color tubes)

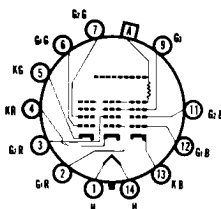

14AH

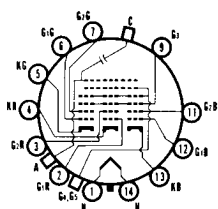

14AL

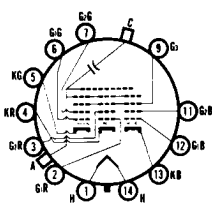

14AU

RATINGS		TYPICAL OPERATION					REMARKS	Type
Focusing Electrode (Kv)	Screen Grid (G2) Volts	Anode (Kv)	Convergence Electrode (Kv) Δ	Focus Electrode (Kv)	Screen Grid (G2) Volts	Neg. Grid -1 or Positive Cathode Voltage for Raster Cutoff		
6.0	650	25	Magnetic	4.2 to 5.4	400	60-125	23EGP22A	
6.0	1000	25	Magnetic	4.2 to 5.0	400	90-190	25AP22	
6.0	1000	25	Magnetic	4.2 to 5.0	400	90-190	25AP22A	
6.0	1000	25	Magnetic	4.2 to 5.0	285-685	95-190	25ABP22	
6.0	1000	25	Magnetic	4.5 to 4.9	350-650	150	25AEP22	
6.0	1000	25	Magnetic	4.4 to 4.8	350-650	150	25AFP22	
6.0	1000	25	Magnetic	4.2 to 5.0	285-685	95-190	25AJP22	
6.0	1000	25	Magnetic	4.5 to 4.9	400-700	150	25AKP22	
6.0	1000	25	Magnetic	4.2 to 5.0	285-685	95-190	25ALP22	
6.0	1000	25	Magnetic	4.5 to 4.9	300-630	150	25ANP22	
6.0	1000	25	Magnetic	4.2 to 5.0	174-460	100	25AQP22	
6.0	1000	25	Magnetic	4.2 to 5.0	175-460	100	25AWP22	
6.0	1000	25	Magnetic	4.5 to 4.9	380-1000	150	25AYP22	
6.0	1000	25	Magnetic	4.2 to 5.0	285-685	95-190	25AZP22	
6.0	1000	25	Magnetic	4.2 to 5.0	400	90-190	25BP22	
6.0	1000	25	Magnetic	4.2 to 5.0	400	90-190	25BP22A	
6.0	1000	25	Magnetic	4.2 to 5.0	400	90-190	25CP22	
6.0	1000	25	Magnetic	4.2 to 4.6	350-1000	150	25FP22	
6.0	1000	25	Magnetic	4.2 to 4.6	350-1000	150	25GP22	
6.0	1000	25	Magnetic	4.5 to 4.9	300-630	150	25WP22	
6.0	1000	25	Magnetic	4.2 to 5.0	285-685	95-190	25XP22	
6.0	1000	25	Magnetic	4.2 to 5.0	285-685	95-190	25YP22	
6.0	1000	25	Magnetic	4.5 to 4.9	400-700	150	25ZP22	

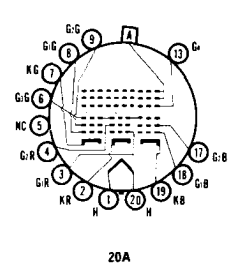
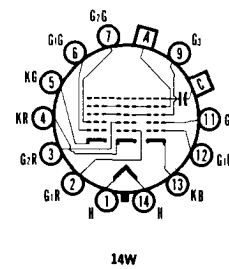
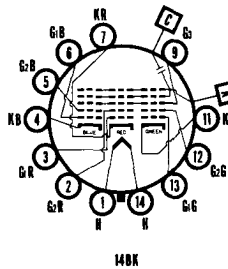
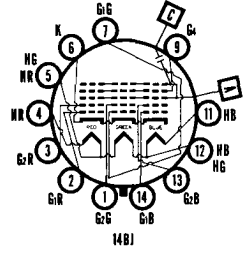
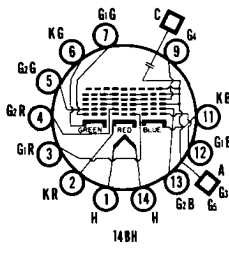
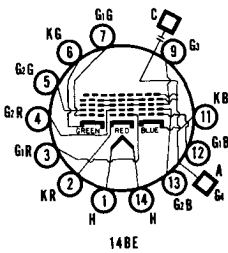

basing diagram symbols

- A—Anode
- C—Conductive Coating
- G1—Grid No. 1
- G2—Grid No. 2, etc.
- H—Heater
- K—Cathode
- Locating Lug
- B—Blue Gun
- G—Green Gun
- R—Red Gun
- Bulb Terminal

# Monochrome TV Picture Tubes Data

Type	Defl. Angle and Neck Dia. ♦	FACEPLATE		OVERALL DIMENSIONS INCHES		External Conductive Coating Capacitance (pf)	** Ion Trap	Base	Basing	Heater▲ Volts/Amps	DESIGN	
		Clear Alumin. Shield* Anti-Ref.		Faceplate Dimensions	Length						Anode (Kv)	
2EP4	30	A		2	8¼	300-500	N	B7-208	8JK	6.0/145		11
5TP4	50	CA		5	11¾	100-500	N	B7-51	12C	6.3/60		29.7
7DP4	50	C		7¾	14¼	400-1500	D	B7-51	12C	6.3/60		8.8
7RP4	50	CA		7¾	14¼	.....	D	B5-57	12D	6.3/60		13.2
8DP4	90	T		7¾ x 6¼	10¾	250-350	S	B6-185	12AB	6.3/60		8.8
8KP4	90	TA		7¾ x 6¼	11¾	.....	N	B6-63	12M	6.3/60		18
9ACP4	90	TA-TB		7¾ x 6¼	8¼	300-750	N	E7-91	7GR	12.0/065		12
9QP4	70	C		8¾ x 6¼	12¾	.....	S	B7-51	12AD	4.7/30		7.5
9QP4A	70	T		8¾ x 6¼	12¾	.....	S	B7-51	12AD	4.7/30		7.5
9SP4	90	A-BP		7¾ x 6¼	10½	300-500	N	B7-183	8HR	6.3/60		18
9TP4	110	A-BF		8¾ x 7¾	8¾	350-600	N	B7-208	8HR	6.3/45		15
9UP4	90	TA		7¾ x 6¼	8¼	300-750	N	E7-91	7GR	12.6/075		12
9VP4	90	TA		7¾ x 6¼	7¾	300-750	N	E7-91	7GR	12.6/075		12
9WP4	90	TA-BR		7¾ x 6¼	8¾	300-750	N	E7-91	7GR	12.0/075		12
9YP4	85	TA-TB		8¾ x 6½	9¼	400-700	N	E7-91	7GR	12.6/080		15
10ABP4	90	C		9¾ x 7½	11¾	400-850	S	B6-63	12L	6.3/60		13.2
10ABP4A	90	CA		9¾ x 7½	11¾	400-850	S	B6-63	12L	6.3/60		13.2
10ABP4B	90	T		9¾ x 7½	11¾	400-850	S	B6-63	12L	6.3/60		13.2
10ABP4C	90	TA		9¾ x 7½	11¾	400-850	S	B6-63	12L	6.3/60		13.2
10ADP4	90	T		9¾ x 7½	11¾	400-850	S	B6-63	12L	8.4/45		13.2
10AEP4	90	T		9¾ x 7½	11¾	400-850	S	B6-63	12L	6.3/45		13.2
10ARP4	90	TA-TB		8¾ x 6¾	9¾	300-750	N	B7-247	7GR	6.3/30		13
10BP4	50	C		10½	17¾	500-2500	D	B5-57	12N	6.3/60		11
10BP4A	50	T		10½	17¾	500-2500	D	B5-57	12N	6.3/60		11
10BP4C	50	CA		10½	17¾	500-2500	S	B5-57	12N	6.3/60		11
10BP4D	50	TA		10½	17¾	500-2500	S	B5-57	12N	6.3/60		11
10FP4	50	CA		10½	17¾	500-2500	N	B5-57	12N	6.3/60		13.2
10FP4A	50	TA		10½	17¾	500-2500	N	B5-57	12N	6.3/60		13.2
10MP4	52	C		10½	17	500-2500	D	B5-57	12G	6.3/60		11
10MP4A	52	T		10½	17	500-2500	D	B5-57	12G	6.3/60		11
10RP4	50	CA		10½	16½	750-1500	N	B6-63	12L	6.3/60		17.6
11AP4	110	TA-BL		9¾ x 8	8¾	500-750	N	B7-208	8HR	6.3/45		15
11BP4	110	TA		9¾ x 8	8¾	500-750	N	B7-208	8HR	6.3/45		15
11CP4	110	TA		9¾ x 8	8¾	500-750	N	B7-208	8HR	6.3/45		15
11DP4	110	TA		9¾ x 8	8¾	500-750	N	B7-208	8HR	6.3/45		15
11EP4	114	TA		8¾ x 7¼	8½	300-500	N	B7-208	8HR	6.3/60		14
11FP4	114	TA		8¾ x 7¼	8½	300-500	N	B7-208	8HR	6.3/45		14
11GP4	110	TA-BF		10¾ x 8¾	8¾	400-600	N	B7-208	8HR	6.3/45		15
11HP4	110	TA-BR		9¾ x 7¾	8¾	500-750	N	B7-208	8HR	6.3/45		15
11HP4A	110	TA-BR		9¾ x 8¾	8¾	500-750	N	B7-208	8HR	6.3/45		15
11JP4	110	TA-BF		10¾ x 8¾	8¾	400-600	N	B7-208	8HR	6.3/30		15
11KP4	110	TA-TB		9¾ x 8¾	8¾	500-750	N	B7-208	8HR	6.3/45		15
11MP4	110	TA-BF		10¾ x 8¾	8¾	400-600	N	B7-208	8HR	6.3/30		15
11QP4	90	TA		9¾ x 7¾	9¾	400-800	N	E7-91	7GR	12.6/075		14
11RP4	90	TA-TB		9¾ x 7¾	9.0	400-750	N	E7-91	7GR	6.3/45		15
11TP4	110	TA-TB		9¾ x 8¾	8¾	400-600	N	B7-208	8HR	6.3/30		15
11UP4	104	TA-TB		9¾ x 7¾	9	400-750	N	B7-247	7GR	6.3/45		15
12AYP4	110	A		10½ x 8¾	9¾	400-900	N	B7-208	8HR	6.3/45		14
12AZP4	110	A		10½ x 8¾	9¾	400-900	N	B7-208	8HR	6.3/60		14
12BAP4	110	A		10½ x 8¾	9¾	400-900	N	B7-208	8HR	6.3/30		14
12BEP4	110	TA-BF		11¾ x 8¾	9¾	500-900	N	B6-214	7FA	6.3/45		16
12BFP4	110	TA		10¾ x 8¾	9¾	400-1200	N	E7-91	7GR	4.2/45		14
12BGP4	110	TA-BF		11¾ x 9¾	9¾	550-850	N	B7-208	8HR	6.3/45		15
12BJP4	110	TA		10¾ x 8¾	9¾	400-900	N	B7-208	8HR	4.2/45		13
12BKP4	110	TA-TB		10¾ x 8¾	9¾	800-1000	N	B7-208	8HR	6.3/45		15
12BLP4	110	TA-TB		10¾ x 8¾	9½	800-1000	N	B7-208	8HR	6.3/45		15
12BMP4	104	TA-TB		11 x 8¾	9¾	500-750	N	E7-91	7GR	6.3/45		16
12BNP4	110	TA-BR		10¾ x 8¾	9½	500-750	N	B7-208	8HR	6.3/45		16
12BNP4A	110	TA-BR		10¾ x 8¾	9½	500-750	N	B7-208	8HR	6.3/45		16
12BQP4	110	TA-BR		10¾ x 8¾	9½	600-900	N	B7-208	8HR	6.3/45		16
12BRP4	90	TA-BR		11¾ x 8¾	10¾	600-1000	N	E9-94	9RS	12.6/08		15
12BSP4	110	TA		10¾ x 8¾	9¾	400-900	N	B7-208	8HR	6.3/30		14
12BTP4	110	TA-BF		11¾ x 9¾	9½	550-850	N	B7-208	8HR	12.6/15		15
12BUP4	110	TA-BR		10¾ x 8¾	9¾	450-900	N	B7-208	8HR	6.3/45		14
12BUP4A	110	TA-BR		10¾ x 8¾	9¾	450-900	N	B7-208	8HR	6.3/45		14

MAXIMUM RATINGS		TYPICAL OPERATION				REMARKS	Type
Focusing Electrode (Kv)	Accel. Grid (G2) Volts	Anode (Kv)	Focus Electrode Volts Magnet Coil Current in Ma.	Accel. Grid (G2) Volts	Negative Grid No. 1 or Positive Cathode Voltage for Raster Cutoff		
-55 to +1.1	550	9	-50 to +350	300	20-30	Neck Diameter 1 1/8 Inches Projection Tube	2EP4
+6.6m	385	27	4900	200	40-100		5TP4
+2.6m	450	6	1430	250	25-65		7DP4
Magnetic	450	9	120 Ma.	250	27-63		7RP4
-55 to +.55	330	8	60 to 360	200	22-51		8DP4
+ 8	700	16	0-400	300	35-72	Welded Tension Band, .788" Neck Diameter 4.7 Volt Heater	8KP4
-50 to +1.1	250	10	0 to 300	100	+30 to +60*		9ACP4
-11 to +.55	330	5.5	0 to 400	200	33-77		9QP4
-11 to +.55	330	5.5	0 to 400	200	35-57		9QP4A
-55 to +1.1	450	14	0-400	300	33-77		9SP4
-55 to +1.1	60	12	140	50	37-53	.788" Neck Diameter .788" Neck Diameter .788" Neck Diameter .788" Neck Diameter	9TP4
-55 to +1.1	250	9	60	100	+35 to +55*		9UP4
-50 to +1.0	250	9	0 to 300	100	38-94		9VP4
-55 to +1.1	250	9	0 to 300	100	+32 to +50*		9WP4
-50 to +1.0	200	12	-200 to +200	100	+30 to +50*		9YP4
-55 to +1.1	550	7.5	0 to 500	300	43-67	8.4 Volt Heater	10ABP4
-55 to +1.1	550	7.5	0 to 500	300	43-67		10ABP4A
-55 to +1.1	550	7.5	0 to 500	300	43-67		10ABP4B
-55 to +1.1	550	7.5	0 to 500	300	43-67		10ABP4C
-55 to +1.1	550	7.5	0 to 500	300	43-77		10ADP4
-55 to +1.1	550	7.5	0 to 500	300	43-67	.840" Neck Diameter	10AEP4
-50 to +1.0	250	9	-250 to +150	140	+31 to +49*		10ARP4
Magnetic	450	9	100 Ma.	250	27-63		10BP4
Magnetic	450	9	110 Ma.	250	27-63		10BP4A
Magnetic	450	9	110 Ma.	250	27-63		10BP4C
Magnetic	450	9	110 Ma.	250	27-63	10BP4D	
Magnetic	450	9	110 Ma.	250	27-63	10FP4	
Magnetic	450	11	110 Ma.	250	27-63	10FP4A	
Magnetic	...	9	.....	...	27-63	10MP4	
Magnetic	...	9	.....	...	27-63	10MP4A	
-55 to +1.1	550	14	-55 to +300	300	33-77	.788" Neck Diameter	10RP4
-50 to +1.0	250	11	250	150	31-49		11AP4
-50 to +1.0	250	11	200	150	31-49		11BP4
-50 to +1.1	550	12	0-400	400	39-94		11CP4
-50 to +1.0	60	11	-100 to +300	50	31-49		11DP4
-55 to +1.1	550	10	0 to 400	400	36-94	Welded Tension Band	11EP4
-55 to +1.1	550	10	0 to 400	400	36-94		11FP4
-50 to +1.0	200	11	-200 to +200	135	27-43		11GP4
-50 to +1.0	250	11	0	150	31-49		11HP4
-50 to +1.0	250	11	0	150	+31 to +49*		11HP4A
-50 to +1.1	70	11	-200 to +200	50	27-43	.788" Neck Diameter	11JP4
-50 to +1.0	70	11	-100 to +300	50	+31 to +49*		11KP4
-50 to +1.1	200	11	-200 to +200	135	27-43		11MP4
-50 to +1.1	250	10	0 to 300	100	32-50		11QP4
-50 to +1.0	250	11	0	140	31-49		11RP4
-50 to +1.0	550	10	0 to 400	400	+36 to +78*	.788" Neck Diameter	11TP4
-50 to +1.0	250	11	0	140	+31 to +49*		11UP4
-55 to +1.1	550	10	0 to 400	400	36-94		12AYP4
-55 to +1.1	550	10	0 to 400	400	36-78		12AZP4
-55 to +1.1	550	10	0 to 400	400	36-78		12BAP4
-50 to +1.1	50	12	0 to 500	30	25-40	.788" Neck Diameter	12BEP4
-55 to +1.1	400	10	0 to 400	200	27-55		12BFP4
-50 to +1.1	60	12	0	50	35-55		12BGP4
-55 to +1.1	600	10	0 to 400	350	30-60		12BJP4
-55 to +1.1	70	12	0 to 400	50	35-55		12BKP4
-55 to +1.1	60	12	0 to 400	30	30-45	.788" Neck Diameter	12BLP4
-50 to +1.0	250	11	0	140	31-49		12BMP4
-55 to +1.1	400	12	0 to 400	250	35-65		12BNP4
-55 to +1.1	400	12	0 to 400	250	35-65		12BNP4A
-50 to +1.1	70	12	0 to 400	50	+30 to +50*		12BP4
-35 to +.45	50	10	0 to 500	30	25-35	.855" Neck Diameter	12BRP4
-55 to +1.1	600	10	0 to 400	500	50-93		12BSP4
-55 to +1.1	60	12	0	50	35-55		12BTP4
-55 to +1.1	60	12	0 to 400	50	37-49		12BUP4
-55 to +1.1	70	12	0 to 400	50	+33 to +52*		12BUP4A

## Monochrome TV Picture Tubes Data (cont'd)

Type	Defl. Angle and Neck Dia. ♦	FACEPLATE		OVERALL DIMENSIONS INCHES		External Coating Capacitance (pf)	** Ion Trap	Base	Basing	Heater Δ Volts/Amps	DESH	
		Clear Tinted Alum. Shield* Anti-Ref.	Faceplate Dimensions	Length	Anode (Kv)							
12BUP4B	110	TA-TB	10 $\frac{1}{2}$ x 8 $\frac{3}{4}$	9 $\frac{1}{4}$	450-900	N	B7-208	8HR	6.3/45	14		
12BVP4	110	TA-BR	10 $\frac{3}{8}$ x 8 $\frac{3}{4}$	9 $\frac{1}{4}$	450-900	N	E7-91	7GR	12.6/.075	14		
12BZP4	104	TA-BR	11 x 8 $\frac{5}{8}$	9 $\frac{1}{2}$	500-750	N	E7-98	7GR	12/.157	15		
12CBP4	110	TA-BR	11 x 9 $\frac{1}{8}$	9 $\frac{1}{2}$	500-900	N	B6-214	7FA	6.3/45	16		
12CDP4	104	TA-TB	11 x 8 $\frac{5}{8}$	9 $\frac{1}{2}$	500-750	N	E7-98	7GR	6.3/45	15		
12CEP4	110	TA-BF	11 $\frac{1}{2}$ x 9 $\frac{1}{4}$	9 $\frac{1}{4}$	600-900	N	E7-91	7GR	12.6/.15	15		
12CFP4	110	TA-BR	10 $\frac{1}{2}$ x 8 $\frac{3}{4}$	9 $\frac{1}{4}$	450-900	N	E7-91	7GR	4.2/.45	14		
12CHP4	110	TA-BR	10 $\frac{1}{2}$ x 8 $\frac{3}{4}$	9 $\frac{1}{4}$	450-900	N	E7-91	7GR	6.3/45	14		
12CNP4	110	TA-BR	10 $\frac{1}{2}$ x 8 $\frac{3}{4}$	9 $\frac{1}{2}$	600-1200	N	E7-91	7GR	4.2/.45	14		
12CNP4A	110	TA-TB	10 $\frac{1}{2}$ x 8 $\frac{3}{4}$	9 $\frac{1}{2}$	600-1200	N	E7-91	7GR	4.2/.45	14		
12CQP4	110	TA-BF	11 $\frac{1}{2}$ x 9 $\frac{3}{8}$	9 $\frac{1}{2}$	400-900	N	B7-208	8HR	6.3/45	15.4		
12CSP4	90	TA-BF	11 $\frac{1}{2}$ x 9 $\frac{1}{4}$	10 $\frac{1}{8}$	600-900	N	E7-91	7GR	12.6/.15	15		
12CTP4	110	TA-TB	10 $\frac{1}{4}$ x 8 $\frac{3}{4}$	9 $\frac{1}{4}$	700-1000	N	E7-91	7GR	6.3/45	15		
12CVP4	100	TA-TB	11 x 8 $\frac{5}{8}$	10 $\frac{1}{2}$	500-750	N	B7-247	7GR	12.0/.157	15		
12CWP4	100	TA-TB	11 x 8 $\frac{5}{8}$	10 $\frac{1}{2}$	500-750	N	B7-247	7GR	6.3/45	15		
12CZP4	110	TA-TB	10 $\frac{1}{2}$ x 8 $\frac{3}{4}$	9 $\frac{1}{4}$	400-1200	N	E7-91	7GR	12.6/.075	14		
12DEP4	110	TA-TB	10 $\frac{3}{4}$ x 8 $\frac{3}{4}$	9 $\frac{1}{2}$	600-900	N	B7-247	7GR	6.3/.450	15		
12DHP4	110	TA-TB	10 $\frac{3}{4}$ x 8 $\frac{3}{4}$	9 $\frac{1}{2}$	600-1200	N	B7-208	8HR	6.3/.450	16		
12KP4	54	CA	12 $\frac{1}{2}$	17 $\frac{1}{2}$	500-2500	N	B5-57	12N	6.3/.60	13.2		
12KP4A	54	TA	12 $\frac{1}{2}$	17 $\frac{1}{2}$	500-2500	N	B5-57	12N	6.3/.60	13.2		
12LP4	54	C	12 $\frac{1}{2}$	18 $\frac{1}{2}$	750-3000	D	B5-57	12N	6.3/.60	13.2		
12LP4A	54	T	12 $\frac{1}{2}$	18 $\frac{1}{2}$	750-3000	D	B5-57	12N	6.3/.60	13.2		
12LP4C	54	TA	12 $\frac{1}{2}$	18 $\frac{1}{2}$	750-3000	D	B5-57	12N	6.3/.60	13.2		
12UP4	54	C	12 $\frac{1}{2}$	18 $\frac{1}{2}$	.....	S	B5-57	12D	6.3/.60	13.2		
12UP4A	54	T	12 $\frac{1}{2}$	18 $\frac{1}{2}$	.....	S	B5-57	12D	6.3/.60	13.2		
12UP4B	54	T, AR	12 $\frac{1}{2}$	18 $\frac{1}{2}$	.....	S	B5-57	12D	6.3/.60	13.2		
12VP4	54	C	12 $\frac{1}{2}$	18	750-3000	D	B5-57	12G	6.3/.60	13.2		
12VP4A	54	T	12 $\frac{1}{2}$	18	750-3000	D	B5-57	12G	6.3/.60	13.2		
12WP4	55	T	12 $\frac{1}{2}$	17 $\frac{1}{2}$	750-2000	S	E9-1	9CH	6.3/.60	13.2		
12YP4	54	C	12 $\frac{1}{2}$	18 $\frac{1}{2}$	750-3000	S	B5-57	12N	6.3/.60	13.2		
12ZP4	54	CA	12 $\frac{1}{2}$	17 $\frac{1}{2}$	500-2500	S	B5-57	12N	6.3/.60	13.2		
12ZP4A	54	TA	12 $\frac{1}{2}$	17 $\frac{1}{2}$	500-2500	S	B5-57	12N	6.3/.60	13.2		
13AP4	110	TA-BF	11 $\frac{1}{2}$ x 9 $\frac{1}{4}$	9 $\frac{1}{4}$	550-850	N	B7-208	8HR	6.3/45	15		
13DP4	110	TA-BF	11 $\frac{3}{8}$ x 9 $\frac{1}{4}$	9 $\frac{1}{2}$	500-1000	N	B7-208	8HR	6.3/45	16		
14ACP4	90	TA	13 $\frac{1}{2}$ x 10 $\frac{1}{2}$	14 $\frac{1}{2}$	800-1200	S	B6-63	12L	6.3/.60	15.4		
14AEP4	90	TA	13 $\frac{1}{4}$ x 10 $\frac{1}{2}$	13 $\frac{1}{2}$	800-1200	N	B6-63	12L	6.3/.60	15.4		
14AJP4	110	TA	13 $\frac{1}{4}$ x 10 $\frac{1}{2}$	11 $\frac{1}{2}$	500-850	S	B7-208	8HR	6.3/.60	12.1		
14ARP4	90	TA	13 x 10 $\frac{1}{2}$	13 $\frac{1}{2}$	800-1200	N	B6-63	12L	6.3/.60	15.4		
14ASP4	110	TA	13 $\frac{1}{4}$ x 10 $\frac{1}{2}$	11 $\frac{1}{2}$	500-850	N	B7-208	8HR	6.3/.60	15.4		
14ATP4	90	TA	13 $\frac{1}{4}$ x 10 $\frac{1}{2}$	13 $\frac{1}{2}$	500-1000	N	B6-63	12L	8.4/.45	15.4		
14AUP4	90	TA	13 $\frac{1}{4}$ x 10 $\frac{1}{2}$	13 $\frac{1}{2}$	1000-1500	N	B6-63	12L	6.3/.45	16.5		
14AVP4	110	TA	13 $\frac{1}{4}$ x 10 $\frac{1}{2}$	11 $\frac{1}{2}$	450-750	N	B7-183/B7-208	8HR	6.3/.60	15.4		
14AWP4	90	TA	13 $\frac{1}{4}$ x 10 $\frac{1}{2}$	13 $\frac{1}{2}$	800-1200	N	B6-63	12L	6.3/.45	15.4		
14BP4	70	T	12 $\frac{1}{2}$ x 9 $\frac{1}{4}$	16 $\frac{1}{2}$	500-2500	S	B5-57	12N	6.3/.60	13.2		
14BP4A	70	T, AR	12 $\frac{1}{2}$ x 9 $\frac{1}{4}$	16 $\frac{1}{2}$	500-2500	S	B5-57	12N	6.3/.60	13.2		
14BAP4	70	TA	12 $\frac{1}{2}$ x 9 $\frac{3}{4}$	16 $\frac{1}{2}$	750-2000	N	B6-63/B6-203	12L	6.3/.60	22		
14BDP4	70	TA-BP	12 $\frac{1}{2}$ x 9 $\frac{3}{4}$	16 $\frac{1}{2}$	600-1000	N	B6-63	12L	6.3/.60	22		
14CP4	70	T	12 $\frac{1}{2}$ x 9 $\frac{1}{4}$	17 $\frac{1}{2}$	750-2000	S	B5-57	12N	6.3/.60	15.4		
14CP4A	70	TA	12 $\frac{1}{2}$ x 9 $\frac{1}{4}$	16 $\frac{1}{2}$	750-2000	S	B5-57	12N	6.3/.60	15.4		
14CP4B	70	TA	12 $\frac{1}{2}$ x 9 $\frac{1}{4}$	16 $\frac{1}{2}$	750-2000	S	B5-57	12N	6.3/.60	15.4		
14DP4	70	T	12 $\frac{1}{2}$ x 9 $\frac{1}{4}$	16 $\frac{1}{2}$	.....	D	B5-57	12D	6.3/.60	15.4		
14EP4	70	T	12 $\frac{1}{2}$ x 9 $\frac{3}{4}$	16 $\frac{1}{2}$	750-2000	S	B5-57	12N	6.3/.60	15.4		
14GP4	70	T	12 $\frac{1}{2}$ x 9 $\frac{3}{4}$	16 $\frac{1}{2}$	750-2000	S	B6-63	12L	6.3/.60	15.4		
14HP4	70	T	12 $\frac{1}{2}$ x 9 $\frac{1}{4}$	16 $\frac{1}{2}$	750-2000	S	B6-63	12L	6.3/.60	15.4		
14NP4	90	T	13 $\frac{1}{4}$ x 10 $\frac{1}{2}$	14 $\frac{1}{2}$	800-1200	S	B6-63	12L	6.3/.60	15.4		
14NP4A	90	TA	13 $\frac{1}{4}$ x 10 $\frac{1}{2}$	14 $\frac{1}{2}$	800-1200	S	B6-63	12L	6.3/.60	15.4		
14QP4	70	T	12 $\frac{1}{2}$ x 9 $\frac{3}{4}$	16 $\frac{1}{2}$	600-1000	S	B6-63	12L	6.3/.60	12.1		
14QP4A	70	TA	12 $\frac{1}{2}$ x 9 $\frac{3}{4}$	16 $\frac{1}{2}$	600-1000	S	B6-63	12L	6.3/.60	12.1		
14QP4B	70	TA	12 $\frac{1}{2}$ x 9 $\frac{3}{4}$	16 $\frac{1}{2}$	600-1000	N	B6-63	12L	6.3/.60	12		
14RP4	90	T	13 $\frac{1}{4}$ x 10 $\frac{1}{2}$	14 $\frac{1}{2}$	800-1200	S	B6-63	12L	6.3/.60	15.4		
14RP4A	90	TA	13 $\frac{1}{4}$ x 10 $\frac{1}{2}$	14 $\frac{1}{2}$	800-1200	S	B6-63	12L	6.3/.60	15.4		
14SP4	90	TA	13 $\frac{1}{4}$ x 10 $\frac{1}{2}$	14 $\frac{1}{2}$	900-1200	S	B6-63	12L	6.3/.60	15.4		
14UP4	70	TA	12 $\frac{1}{2}$ x 9 $\frac{1}{4}$	16 $\frac{1}{2}$	.....	N	B5-57	12D	6.3/.60	15.4		
14WP4	90	TA	13 $\frac{1}{4}$ x 10 $\frac{1}{2}$	13 $\frac{1}{2}$	800-1200	N	B6-63	12L	6.3/.60	15.4		
14XP4	90	T	13 $\frac{1}{4}$ x 10 $\frac{1}{2}$	14 $\frac{1}{2}$	1100-1500	S	B6-63	12L	6.3/.45	16.5		



MAXIMUM RATINGS		TYPICAL OPERATION				REMARKS	Type
Focusing Electrode (Kv)	Accel. Grid (G2) Volts	Anode (Kv)	Focus Electrode Volts Magnet Coil Current in Ma.	Accel. Grid (G2) Volts	Negative Grid No. 1 or Positive Cathode Voltage for Raster Cutoff		
-50 to +1.1	70	12	0 to 400	50	+35 to +55*		12BUP4B
-55 to +1.1	70	12	0 to 400	50	37-49	.788" Neck Diameter	12BVP4
-50 to +1.0	200	11	0	100	+31 to +49*	.788" Neck Diameter	12BZP4
-50 to +1.1	50	12	0 to 500	50	+30 to +50*		12CBP4
-50 to +1.0	250	11	0	140	+31 to +49*	.788" Neck Diameter	12CDP4
-50 to +.50	150	12	-200 to +200	100	+30 to +50*	.788" Neck Diameter	12CEP4
-55 to +1.1	400	10	0 to 300	200	+27 to +57*	.788" Neck Diameter	12CFP4
-55 to +1.1	550	10	0 to 400	300	30-72	.788" Neck Diameter	12CHP4
-55 to +1.1	400	10	0 to 400	200	+25 to +55*	.788" Neck Diameter	12CNP4
-40 to +.55	400	10	0 to 400	200	+25 to +55*	.788" Neck Diameter	12CNP4A
-55 to +1.1	60	12	0 to 400	40	+30 to +50*		12CQP4
-50 to +.50	150	12	-200 to +200	100	+30 to +50*	.788" Neck Diameter	12CSP4
-50 to +.50	150	12	-200 to +200	100	+30 to +50*	.788" Neck Diameter	12CTP4
-50 to +1.0	200	11	0	100	+31 to +49*	.840" Neck Diameter	12CVP4
-50 to +1.0	250	11	0	140	+31 to +49*	.840" Neck Diameter	12CWP4
-55 to +1.1	250	12	0 to 400	100	+33 to +52*	.788" Neck Diameter	12CZP4
-50 to +.50	150	12	-200 to +200	100	+30 to +50*	.840" Neck Diameter	12DEP4
-55 to +1.1	80	12	0 to 400	50	+30 to +50*		12DHP4
Magnetic	450	10	135 Ma.	250	27-63		12KPA
Magnetic	450	11	135 Ma.	250	27-63		12KPA4
Magnetic	450	11	110 Ma.	250	27-63		12LPA
Magnetic	450	11	110 Ma.	250	27-63		12LPA4
Magnetic	450	11	110 Ma.	250	27-63	Metal Bulb	12LPA4
Magnetic	450	11	110 Ma.	250	27-63	Metal Bulb	12UP4
Magnetic	450	11	110 Ma.	250	27-63	Metal Bulb	12UP4A
Magnetic	450	11	130 Ma.	250	27-63	Metal Bulb	12UP4B
Magnetic	...	13.2	.....	...	33-77		12VP4
Magnetic	...	13.2	.....	...	33-77		12VP4A
Magnetic	...	10	240 Gauss	...	27-63	.870" Neck Diameter	12WP4
Auto Es.	450	11	Auto. Es.	250	33-73		12WP4
Magnetic	450	11	135 Ma.	250	27-63		12ZP4
Magnetic	450	11	135 Ma.	250	27-63		12ZP4A
-50 to +1.1	60	12	0 to 400	50	35-55		13AP4
-50 to +1.1	50	12	0 to 250	50	+30 to +50*		13DP4
-55 to +.55	220	10	-50 to +350	125	45-85		14ACP4
-55 to +1.1	220	10	-50 to +350	125	37-55		14AEP4
-55 to +1.1	550	9	-100 to +400	250	29-69		14AJP4
+1.1	77	10	-50 to +350	50	50		14ARP4
-55 to +1.1	550	12	-50 to +350	300	33-77		14ASP4
-55 to +1.1	550	14	0 to 400	400	36-95		14ATP4
-55 to +1.1	70	12	0 to 350	50	35-55		14AUP4
-55 to +1.1	550	12	-50 to +350	300	33-77		14AVP4
-55 to +1.1	75	14	0 to 400	50	37-52		14AWP4
Magnetic	450	12	110 Ma.	250	33-77		14BP4
Magnetic	450	12	110 Ma.	250	33-77		14BP4A
+8	700	18	0 to 400	300	33-77		14BP4A
-50 to +.80	700	18	0 to 400	300	33-77		14BDP4
Magnetic	450	12	115 Ma.	300	33-77		14CP4
Magnetic	450	12	115 Ma.	300	33-77		14CP4A
Magnetic	450	12	115 Ma.	300	33-77		14CP4B
Magnetic	450	11	100 Ma.	250	27-63		14DP4
Magnetic	450	12	110 Ma.	300	33-77		14EP4
+9.5	450	12	2170 to 2940	300	33-77		14GP4
-55 to +.55	450	12	-48 to +264	300	33-77		14HP4
-55 to +1.1	550	12	-50 to +350	300	33-77		14NP4
-55 to +1.1	550	12	-50 to +350	300	33-77		14NP4A
-55 to +1.1	550	9	-50 to +250	250	29-69		14QP4
-55 to +1.1	550	9	-50 to +250	250	29-69		14QP4A
-55 to +1.1	550	9	-50 to +250	250	29-69		14QP4B
-55 to +.55	440	14	70 to 470	300	31-75		14RP4
-55 to +.55	440	14	70 to 470	300	31-75		14RP4A
-55 to +1.1	550	12	-48 to +264	300	33-77		14SP4
Magnetic	550	12	105 Ma.	300	33-77		14UP4
-55 to +1.1	550	12	-50 to +350	300	33-77		14WP4
-55 to +1.1	440	12	-50 to +350	300	33-77		14XP4

# Monochrome TV Picture Tubes Data (cont'd)

Type	Defl. Angle and Neck Dia. ⚡	FACEPLATE		OVERALL DIMENSIONS INCHES		External Conductive Coating Capacitance (pf)	** Ion Trap	Base	Basing	Heater▲ Volts/Amps	Anode (Kv)	DESIK
		Clear Tinted Alum. Shield* Anti-Refli.		Faceplate Dimensions	Length							
14XP4A	90	TA		13 1/8 x 10 1/8	14 3/8	1100-1500	S	B6-63	12L	6.3/45	16.5	
14ZP4	90	TA		13 1/8 x 10 1/8	13 3/8	800-1200	N	B6-63	12L	6.3/60	15.4	
15ADP4	110	TA-TB		12 5/8 x 10 1/8	10 3/8	700-1100	N	B7-208	8HR	6.3/45	20	
15JP4	110	TA-BF		13 1/8 x 10 1/8	11 1/4	600-1000	N	B7-208	8HR	6.3/45	15	
16AP4	53	C		15 5/8	22 1/4	.....	D	B5-57	12D	6.3/60	15.4	
16AP4A	53	T		15 5/8	22 3/8	.....	D	B5-57	12D	6.3/60	15.4	
16ABP4	70	T		14 3/4 x 11 1/8	18 3/4	750-1500	S	B5-57	12D	6.3/60	17.6	
16ACP4	60	C		15 5/8	20 3/8	2000m	S	B5-57	12D	6.3/60	15.4	
16AEP4	70	T		14 3/4 x 11 1/8	18 3/8	750-1500	S	B6-63	12L	6.3/60	17.6	
16ANP4	114	TA-BP		13 3/4 x 11 3/8	10 3/8	800-1200	N	B7-208	8HR	6.3/60	18	
16AQP4	114	TA-AR-BP		13 3/4 x 11 3/8	10 3/8	800-1200	N	B7-208	8HR	6.3/60	18	
16ASP4	114	TA-BP		13 3/4 x 11 3/8	10 3/8	1000-1500	N	B7-208	8HR	6.3/60	20	
16ATP4	114	TA-BL		13 3/4 x 11 3/8	10 5/8	1000-1500	N	B7-208	8HR	6.3/45	18	
16AUP4	114	TA		13 3/4 x 11 3/8	10 1/8	800-1500	N	B7-237	8HR	6.3/60	15.4	
16AVP4	114	TA-BP		13 3/4 x 11 3/8	10 1/8	900-1400	N	B6-214	7FA	6.3/45	17.6	
16AWP4	114	TA-BL		13 3/4 x 11 3/8	10 5/8	1000-1500	N	B7-208/B7-237	8HR	6.3/30	18	
16AXP4	114	TA-BP		13 3/4 x 11 3/8	10 5/8	1000-1500	N	B7-208	8HR	6.3/45	18	
16AYP4	114	TA		13 3/4 x 11 1/4	10 3/8	800-1300	N	B7-208	8HR	6.3/45	20	
16AZP4	114	TA-BL		13 3/4 x 11 3/8	10 3/8	1000-1500	N	B7-208/B7-237	8HR	6.3/45	18	
16BAP4	114	TA-BP		13 3/4 x 11 3/8	10 1/8	1000-1500	N	B7-208	8HR	6.3/60	18	
16BDP4	114	TA		13 3/4 x 11 1/4	10 3/8	800-1300	N	B7-208	8HR	6.3/60	20	
16BEP4	114	TA-BP		13 3/4 x 11 3/8	10 1/8	800-1200	N	B7-208	8HR	6.3/60	18	
16BFP4	114	TA		13 3/4 x 11 3/8	10 3/8	800-1500	N	B7-208	8HR	6.3/45	15.4	
16BP4	114	TA-BR		13 3/4 x 11 1/4	10 3/8	800-1300	N	B7-208	8HR	6.3/45	20	
16BMP4	114	TA		13 3/4 x 11 3/8	10 3/8	800-1500	N	B7-208	8HR	6.3/45	15.4	
16BNP4	114	TA		13 3/4 x 11 3/8	10 1/2	1000-1500	N	B7-208	8HR	6.3/60	18	
16BRP4	114	TA-BR		13 3/4 x 11 1/8	10 3/8	1000-1500	N	B7-208	8HR	6.3/60	18	
16BSP4	114	TA-BR		13 3/4 x 11 1/8	10 1/2	1000-1500	N	B7-208	8HR	6.3/45	21	
16BUP4	114	TA-BL		13 3/4 x 11 3/8	10 3/8	1000-1500	N	B7-208	8HR	6.3/45	16	
16BVP4	114	TA-TB		13 3/4 x 11 3/8	10 1/2	1050-1450	N	B7-208	8HR	6.3/45	20	
16BWP4	114	TA-BR		13 3/4 x 11 3/8	10 3/8	800-1300	N	B7-208	8HR	6.3/45	20	
16BXP4	114	TA-BF		14 3/8 x 11 3/4	10 3/8	900-1400	N	B6-214	7FA	6.3/45	17.6	
16BYP4	114	TA-BR		13 3/4 x 11 3/8	10 3/8	1000-1500	N	B7-208	8HR	6.3/45	16	
16CP4	52	C		15 5/8	21 1/2	.....	D	B5-57	12D	6.3/60	16.5	
16CA4	114	TA-BR		13 3/4 x 11 3/8	10 1/2	1000-1500	N	B7-208	8HR	6.3/45	18	
16CEP4	114	TA-BR		13 3/4 x 11 3/8	10 1/2	1000-1500	N	B7-208	8HR	6.3/45	18	
16CFP4	104	TA-BR		13 3/4 x 11 3/8	11 3/4	1000-1500	N	E7-91	7GR	6.3/45	15	
16CHP4	114	TA-BR		13 3/4 x 11 1/4	10 3/8	1000-1500	N	B7-208	8HR	6.3/45	20	
16CHP4A	114	TA-TB		13 3/4 x 11 1/4	10 3/8	1000-1500	N	B7-208	8HR	6.3/45	20	
16CKP4	114	TA-BR		13 3/4 x 11 1/8	10 3/8	1000-1500	N	B7-208	8HR	6.3/30	18	
16CMP4	114	TA-BR		13 3/4 x 11 1/8	10 1/2	1000-1500	N	B7-208	8HR	6.3/45	18	
16CMP4A	114	TA-BR		13 3/4 x 11 1/4	10 3/8	1000-1500	N	B7-208	8HR	6.3/45	18	
16CNP4	104	TA-TB		13 3/4 x 11 3/8	11 1/4	1000-1500	N	E7-98	7GR	12.0/157	15	
16QP4	104	TA-TB		13 3/4 x 11 3/8	11 1/4	1000-1500	N	E7-98	7GR	6.3/45	15	
16CTP4	114	TA-TB		13 3/4 x 11 3/8	10 3/8	800-1500	N	B7-208	8HR	6.3/45	15.4	
16CUP4	114	TA-TB		13 3/4 x 11 3/8	10 3/8	800-1500	N	B7-208	8HR	6.3/45	15.4	
16CWP4	100	TA-BR		13 3/4 x 11 3/8	11 1/4	1000-1500	N	B7-247	7GR	6.3/45	15	
16CXP4	100	TA-BR		13 3/4 x 11 3/8	11 1/4	1000-1500	N	B7-247	7GR	12.0/157	15	
16DP4	60	C		15 5/8	20 3/4	.....	D	B5-57	12D	6.3/60	16.5	
16DP4A	60	T		15 5/8	20 3/4	.....	D	B5-57	12D	6.3/60	16.5	
16DCP4A	100	TA-TB		13 3/4 x 11 1/4	11 3/4	1000-1500	N	B7-247	7GR	6.3/45	15	
16EP4	60	C		15 5/8	19 3/8	.....	D	B5-57	12D	6.3/60	15.4	
16EP4A	60	T		15 5/8	19 3/8	.....	D	B5-57	12D	6.3/60	15.4	
16EP4B	60	T, AR		15 5/8	19 3/8	.....	S	B5-57	12D	6.3/60	15.4	
16FP4	62	C		16 5/8	20 1/4	.....	D	B5-57	12D	6.3/60	17.6	
16GP4	70	T		15 5/8	17 1/8	.....	S	B5-57	12D	6.3/60	15.4	
16GP4A	70	C		15 5/8	17 1/8	.....	S	B5-57	12D	6.3/60	15.4	
16GP4B	70	T, AR		15 5/8	17 1/8	.....	S	B5-57	12D	6.3/60	15.4	
16GP4C	70	C, AR		15 5/8	17 1/8	.....	S	B5-57	12D	6.3/60	15.4	
16HP4	60	C		15 5/8	21 1/4	.....	D	B5-57	12N	6.3/60	15.4	
16HP4A	60	T		15 5/8	21 1/4	.....	D	B5-57	12N	6.3/60	15.4	
16JP4	60	C		16 1/8	20 3/4	750-2000	D	B5-57	12N	6.3/60	15.4	

MAXIMUM RATINGS		TYPICAL OPERATION				REMARKS	Type
Focusing Electrode (Kv)	Accel. Grid (G2) Volts	Anode (Kv)	Focus Electrode Volts Magnet Coil Current in Ma.	Accel. Grid (G2) Volts	Negative Grid No. 1 or Positive Cathode Voltage for Raster Cutoff		
-55 to +1.1	440	12	-50 to +350	300	33-77	Metal Bulb	14XP4A
-55 to +1.1	500	12	0 to 450	300	33-77		14ZP4
-50 to +1.15	70	16	-200 to +200	50	+33 to +52*		15ADP4
-50 to +1.1	60	12	0 to 400	50	35-55		15JP4
Magnetic	450	12	80 Ma.	300	33-77		16AP4
Magnetic	450	12	80 Ma.	300	33-77	Metal Bulb	16AP4A
Auto. Es.	550	12	Auto Es.	300	33-77		16ABP4
Auto. Es.	450	12	Auto. Es.	250	33-68		16ACP4
-55 to +1.1	450	12	-64 to +350	300	33-77		16AEP4
-55 to +1.1	550	14	0 to 400	300	33-70		16ANP4
-55 to +1.1	550	14	0 to 400	300	33-70	16AQP4	
-55 to +1.1	550	15	-100 to +300	300	43-70		16ASP4
-50 to +1.0	100	15	0 to 500	50	31-49		16ATP4
-55 to +1.1	550	12	0 to 400	400	36-94	16AUP4	
-50 to +1.1	60	15	0 to 500	35	25-50	16AVP4	
-50 to +1.0	300	15	0 to 500	150	31-49		16AWP4
-50 to +1.0	550	15	0 to 500	300	40-72	16AXP4	
-55 to +1.1	550	16	-100 to +300	300	28-60	16AYP4	
-50 to +1.0	250	15	0 to 400	150	31-49	16AZP4	
-50 to +1.1	60	15	0 to 400	50	35-53		16BAP4
-55 to +1.1	550	16	-100 to +300	300	28-60	16BDP4	
-40 to +1.25	70	14	0 to 400	50	30-48	16BEP4	
-50 to +1.1	550	12	0 to 400	400	36-94	16BFP4	
-55 to +1.1	550	16	-100 to +300	300	28-60		16BGP4
-55 to +1.1	550	12	0 to 400	400	36-94	16BNP4	
-50 to +1.1	60	15	0 to 400	50	35-55	16BRP4	
-50 to +1.1	550	15	0 to 400	400	46-94	16BSP4	
-50 to +1.1	60	15	0 to 400	50	35-55		16BUP4
-50 to +1.0	200	13	0	100	31-49	16BVP4	
-55 to +1.1	550	15	-200 to +200	300	43-70	16BWP4	
-55 to +1.1	550	16	-200 to +200	300	35-72	16BXP4	
-50 to +1.1	60	15	0 to 500	35	25-50	16BYP4	
-50 to +1.0	200	13	0	100	31-49		16BP4
Magnetic	450	12	110 Ma.	250	27-63	16CP4	
-50 to +1.1	550	15	0 to 400	400	46-94	16CAP4	
-50 to +1.1	550	15	0 to 400	400	46-94	16CEP4	
-50 to +1.0	250	11	0	140	31-49	16CFP4	
-55 to +1.1	60	16	0 to 400	30	30-45	Welded Tension Band	16CHP4
-55 to +1.1	60	16	0 to 400	30	30-45		16CHP4A
-50 to +1.1	550	15	0 to 400	400	46-94		16CKP4
-50 to +1.1	550	15	0 to 400	400	46-94		16CMP4
-55 to +1.1	550	16	-100 to +300	300	+28 to +60*		16CMP4A
-50 to +1.0	200	11	0	100	+31 to +49*	.788" Neck Diameter	16CNP4
-50 to +1.0	250	11	0	140	+31 to +49*		16CP4A
-55 to +1.1	550	12	0 to 400	400	36-94	16CTP4	
-55 to +1.1	550	12	0 to 400	400	36-94	16CUP4	
-50 to +1.0	250	11	0	140	+31 to +49*	.840" Neck Diameter	16CWP4
-50 to +1.0	200	11	0	100	+31 to +49*	.840" Neck Diameter	16CXP4
Magnetic	450	12	115 Ma.	250	27-63		16DP4
Magnetic	450	12	115 Ma.	250	27-63	16DP4A	
-50 to +1.0	250	11	-200 to +200	140	+31 to +49*	.840" Neck Diameter	16DCP4A
Magnetic	450	12	105 Ma.	300	33-77	Metal Bulb	16EP4
Magnetic	450	12	105 Ma.	300	33-77	Metal Bulb	16EP4A
Magnetic	450	12	105 Ma.	300	33-77	Metal Bulb	16FP4
Magnetic	450	13	146 Ma.	250	27-63	Metal Bulb	16GP4
Magnetic	450	12	100 Ma.	300	33-77	Metal Bulb	16GP4A
Magnetic	450	12	100 Ma.	300	33-77	Metal Bulb	16GP4B
Magnetic	450	12	100 Ma.	300	33-77	Metal Bulb	16GP4C
Magnetic	450	12	110 Ma.	300	33-77	Metal Bulb	16HP4
Magnetic	450	12	110 Ma.	300	33-77	Metal Bulb	16HP4A
Magnetic	450	11	115 Ma.	250	27-63	Metal Bulb	16JP4

## Monochrome TV Picture Tubes Data (cont'd)

Type	Defl. Angle and Neck Dia. ♦	FACEPLATE		OVERALL DIMENSIONS INCHES		External Conductive Coating Capacitance (pF)	** Ion Trap	Base	Basing	Heater▲ Volts/Amps	DES
		Clear Tinted Alum. Shield* Anti-Ref.	Faceplate Dimensions	Length	Anode (Kv)						
16JP4A	60	T	16½	20¼	750-2000	D	B5-57	12N	6.3/60	15.4	
16KP4	70	T	14¾ x 11½	18¾	750-1500	S	B5-57	12N	6.3/60	17.6	
16KP4A	70	TA	14¾ x 11½	18¾	750-1500	S	B5-57	12N	6.3/60	17.6	
16LP4	52	C	15½	22¼	750-2000	D	B5-57	12N	6.3/60	15.4	
16LP4A	52	T	15½	22¼	750-2000	D	B5-57	12N	6.3/60	15.4	
16MP4	60	C	16½	21¾	1500-3500	D	B5-57	12N	6.3/60	15.4	
16MP4A	60	T	16½	21¾	1500-3500	D	B5-57	12N	6.3/60	15.4	
16QP4	70	T	14¾ x 11½	19½	.....	D	B5-57	12D	6.3/60	17.6	
16RP4	70	T	14¾ x 11½	18¾	750-1500	S	B5-57	12N	6.3/60	17.6	
16RP4A	70	TA	14¾ x 11½	18¾	750-1500	S	B5-57	12N	6.3/60	17.6	
16RP4B	70	TA	14¾ x 11½	18¾	750-1500	N	B5-57	12N	6.3/60	17.6	
16SP4	70	C	15½	17¾	1500-3500	D	B5-57	12N	6.3/60	15.4	
16SP4A	70	T	15½	17¾	1500-3500	D	B5-57	12N	6.3/60	15.4	
16TP4	70	T	14¾ x 11½	18½	750-2000	S	B5-57	12N	6.3/60	15.4	
16UP4	70	T	14¾ x 11½	18½	.....	S	B5-57	12D	6.3/60	16.5	
16VP4	70	T	15½	17¾	.....	S	B5-57	12D	6.3/60	16.5	
16WP4	70	T	15½	17¾	.....	D	B5-57	12D	6.3/60	16.5	
16WP4A	70	T	15½	17¾	750-1500	D	B5-57	12N	6.3/60	17.6	
16WP4B	70	TA	15½	17¾	750-1500	D	B5-57	12N	6.3/60	17.6	
16XP4	70	T	14¾ x 11½	18¾	.....	D	B5-57	12D	6.3/60	16.5	
16YP4	70	T	15½	17¾	750-2000	S	B5-57	12N	6.3/60	15.4	
16ZP4	52	T	15½	22¼	750-1500	D	B5-57	12N	6.3/60	17.6	
17AP4	70	T	15½ x 12¼	18½	750-2000	S	B5-57	12N	6.3/60	17.6	
17ATP4	90	T	15½ x 12¼	15½	750-1500	S	B6-63	12L	6.3/60	17.6	
17ATP4A	90	TA	15½ x 12¼	15½	750-1500	S	B6-63	12L	6.3/60	17.6	
17AVP4	90	T	15½ x 12¼	15½	1200-1500	S	B6-63	12L	6.3/60	17.6	
17AVP4A	90	TA	15½ x 12¼	15½	1200-1500	S	B6-63	12L	6.3/60	17.6	
17BP4	70	T	15½ x 12½	19¾	.....	S	B5-57	12D	6.3/60	17.6	
17BP4A	70	T	15½ x 12½	19¾	750-1500	S	B5-57	12N	6.3/60	17.6	
17BP4B	70	TA	15½ x 12½	19¾	750-1500	S	B5-57	12N	6.3/60	17.6	
17BP4C	70	T, AR	15½ x 12½	19¾	750-1500	S	B5-57	12N	6.3/60	17.6	
17BP4D	70	TA	15½ x 12½	19¾	750-1500	N	B5-57	12N	6.3/60	17.6	
17BJP4	90	TA	15½ x 12½	15½	1000-1500	N	B6-63	12L	6.3/60	17.6	
17BKP4	90	T	15½ x 12½	15½	1200-1500	S	B6-63	12L	6.3/45	17.6	
17BKP4A	90	TA	15½ x 12½	15½	1200-1500	S	B6-63	12L	6.3/45	17.6	
17BMP4	90	TA	15½ x 12½	15½	750-1500	S	B6-63	12L	6.3/60	19.8	
17BNP4	90	TA	15½ x 12½	14½	750-1500	N	B6-63	12L	6.3/60	19.8	
17BRP4	110	TA	15½ x 12¼	12¾	1000-1500	S	B7-208	8HR	6.3/60	16.5	
17BSP4	90	TA	15½ x 12½	14½	1200-1500	N	B6-63	12L	6.3/45	17.6	
17BTP4	90	TA	15½ x 12¼	15½	900-1400	S	B7-51	12AJ	6.3/30	19.8	
17BUP4	90	TA	15½ x 12½	15¼	1200-1500	S	B6-63	12L	6.3/60	19.8	
17BVP4	110	TA	15½ x 12¾	13¼	1000-1500	S	B6-185	7FA	6.3/60	17.6	
17BWP4	110	TA	15½ x 12¾	12¾	1000-1500	N	B6-185	7FA	6.3/60	17.6	
17BYP4	110	TA	15½ x 12¾	12¾	1000-1500	N	B6-185	7FA	6.3/45	17.6	
17BZP4	110	TA	15½ x 12¾	12¾	1000-1500	N	B7-183	8HR	6.3/60	17.6	
17CP4	70	T, AR	15½ x 12¼	18½	.....	S	B5-57	12D	6.3/60	17.6	
17CP4A	70	T	15½ x 12¼	18½	.....	S	B5-57	12D	6.3/60	17.6	
17CAP4	110	TA	15½ x 12¼	12¾	1000-1500	N	B7-183/B7-208	8HR	6.3/60	17.6	
17CBP4	90	T	15½ x 12½	15¼	1000-1500	S	B6-63	12L	6.3/60	19.8	
17CDP4	110	TA	15½ x 12¼	12¾	800-1500	N	B7-183/B7-208	8HR	8.4/45	17.6	
17CEP4	90	TA	15½ x 12¾	15	1200-1500	N	B6-63	12L	6.3/45	17.6	
17CFP4	90	TA	15½ x 12¾	15	1200-1500	N	B6-63	12L	6.3/60	17.6	
17CGP4	70	TA	15½ x 12¼	17¾	500-750	N	B6-63	12L	6.3/60	15.4	
17CKP4	110	TA	15½ x 12¾	12¾	1000-1500	N	B7-183	8HR	6.3/60	16.5	
17CLP4	90	TA	15½ x 12¾	15½	1800-2300	S	B6-63	12L	6.3/60	17.6	
17CMP4	90	TA	15½ x 12¼	14½	1000-1500	N	B6-63	12L	6.3/60	17.6	
17CNP4	90	TA	15½ x 12¼	15	1000-1500	N	B6-63	12L	6.3/60	17.6	
17CRP4	90	TA	15½ x 12¾	14½	1700-2200	N	B6-63	12L	6.3/45	17.6	
17CSP4	110	TA	15½ x 12¾	12¾	900-1400	N	B6-185	7FA	6.3/60	17.6	
17CTP4	110	TA	15½ x 12¾	12¾	1000-1500	N	B7-208	8HR	6.3/45	17.6	
17CUP4	90	TA	15½ x 12¾	15	1200-1500	N	B6-63	12L	6.3/30	17.6	
17CVP4	110	TA	15½ x 12¾	12¾	1000-1500	N	B7-183/B7-208	8HR	6.3/30	17.6	
17CWP4	110	TA	15½ x 12¾	11¾	1000-1500	N	B7-183	8HR	6.3/60	17.6	
17CXP4	90	TA	15½ x 12¼	14½	1000-1500	N	B6-63	12L	6.3/45	17.6	
17CYP4	90	TA	15½ x 12¾	14	1000-1500	N	B6-63	12L	6.3/60	17.6	

MAXIMUM RATINGS		TYPICAL OPERATION				REMARKS	Type
Focusing Electrode (Kv)	Accel. Grid (G2) Volts	Anode (Kv)	Focus Electrode Volts	Accel. Grid (G2) Volts	Negative Grid No. 1 or Positive Cathode Voltage for Raster Cutoff		
			Magnet Coil Current in Ma.				
Magnetic	450	11	115 Ma.	250	27-63		16JP4A
Magnetic	450	14	90 Ma.	300	33-77		16KP4
Magnetic	450	14	90 Ma.	300	33-77		16KP4A
Magnetic	450	12	110 Ma.	300	33-77		16LP4
Magnetic	450	12	110 Ma.	300	33-77		16LP4A
Magnetic	450	12	110 Ma.	300	33-77		16MP4
Magnetic	450	12	110 Ma.	300	33-77		16MP4A
Magnetic	450	14	150 Ma.	250	27-63		16QP4
Magnetic	450	12	100 Ma.	300	33-77		16RP4
Magnetic	450	12	100 Ma.	300	33-77		16RP4A
Magnetic	450	12	100 Ma.	300	33-77		16RP4B
Magnetic	450	12	110 Ma.	300	33-77		16SP4
Magnetic	450	12	110 Ma.	300	33-77		16SP4A
Magnetic	450	12	115 Ma.	300	33-77		16TP4
Magnetic	450	12	100 Ma.	300	27-63		16UP4
Magnetic	450	12	110 Ma.	250	27-63		16VP4
Magnetic	450	12	110 Ma.	250	27-63		16WP4
Magnetic	450	12	110 Ma.	250	27-63		16WP4A
Magnetic	450	12	110 Ma.	250	27-63		16WP4B
Magnetic	450	12	100 Ma.	250	27-63		16XP4
Magnetic	450	12	100 Ma.	300	33-77		16YP4
Magnetic	450	12	110 Ma.	300	33-77		16ZP4
Magnetic	450	12	100 Ma.	300	33-77		17AP4
-55 to +1.1	550	14	-55 to +300	300	33-77		17ATP4
-55 to +1.1	550	14	-55 to +300	300	33-77		17ATP4A
-55 to +1.1	550	14	-56 to +310	300	33-77		17AVP4
-55 to +1.1	550	14	-56 to +310	300	33-77		17AVP4A
Magnetic	450	12	100 Ma.	300	33-77		17BP4
Magnetic	450	12	100 Ma.	300	33-77		17BP4A
Magnetic	450	12	100 Ma.	300	33-77		17BP4B
Magnetic	450	12	100 Ma.	300	33-77		17BP4C
Magnetic	450	12	100 Ma.	300	33-77		17BP4D
-55 to +1.1	550	14	-55 to +300	300	33-77		17BJP4
-55 to +1.1	550	14	-56 to +310	300	33-77		17BKP4
-55 to +1.1	550	14	-56 to +310	300	33-77		17BKP4A
-55 to +1.1	220	14	-55 to +300	110	+37 to +55*		17BMP4
-55 to +1.1	220	14	-50 to +350	110	+37 to +55*		17BNP4
-55 to +1.1	550	14	0 to 500	300	33-77		17BRP4
-55 to +1.1	550	14	-50 to +350	300	33-77		17BSP4
-55 to +.55	550	16	-75 to +235	300	40-80		17BTP4
-55 to +.55	550	12	-48 to +264	300	33-77		17BUP4
-55 to +1.1	550	14	-50 to +350	300	40-77		17BVP4
-55 to +1.1	550	14	-50 to +350	300	40-77		17BWP4
-55 to +1.1	550	14	0 to 400	300	40-77		17BYP4
-55 to +1.1	550	14	0 to 400	300	33-77		17BZP4
Magnetic	450	14	104 Ma.	300	33-77	Metal Bulb	17CP4
Magnetic	450	14	104 Ma.	300	33-77	Metal Bulb	17CP4A
-55 to +1.1	550	14	-50 to +350	300	40-77		17CAP4
-55 to +1.1	550	12	-50 to +350	300	33-77		17CBP4
-55 to +1.1	550	14	0 to 400	300	33-77	8.4 Volt Heater	17CDP4
-55 to +1.1	550	14	-50 to +350	300	33-77	Light Weight Bulb	17CEP4
-55 to +1.1	550	14	-50 to +350	300	33-77	Light Weight Bulb	17CFP4
-55 to +1.1	550	11	-56 to +310	300	33-77		17CGP4
-55 to +1.1	550	14	0 to 500	300	33-77		17CKP4
-55 to +1.1	550	14	-48 to +264	300	40-77		17CLP4
-55 to +1.1	70	14	0 to 400	50	+40 to +55*	Light Weight Bulb	17CMP4
-55 to +1.1	70	14	0 to 400	50	+40 to +55*	Light Weight Bulb	17CNP4
-55 to +1.1	70	14	0 to 350	50	+35 to +55*	Light Weight Bulb	17CRP4
-55 to +1.1	550	14	-50 to +350	300	40-77		17CSP4
-55 to +1.1	550	14	0 to 400	300	40-77		17CTP4
-55 to +1.1	550	14	-50 to +350	300	40-77	Light Weight Bulb	17CUP4
-55 to +1.1	550	14	0 to 400	300	40-77	Light Weight Bulb	17CVP4
-55 to +1.1	550	14	-50 to +350	400	41-97	Light Weight Bulb	17CWP4
-55 to +1.1	75	14	-50 to +350	50	+37 to +52*	Light Weight Bulb	17CXP4
-55 to +1.1	550	14	-50 to +350	450	44-110	Light Weight Bulb	17CYP4

# Monochrome TV Picture Tubes Data (cont'd)

Type	Defl. Angle and Neck Dia. $\downarrow$	FACEPLATE		OVERALL DIMENSIONS INCHES		External Conductive Coating Capacitance (pf)	** Ion Trap	Base	Basing	Heater $\Delta$ Volts/Ampl	Anode (Kv)	DESH
		Clear Tinted Alum. Shield* Anti-Refll.	Faceplate Dimensions	Length								
17CZP4	90	TA	15 3/8 x 12 1/4	13 3/8	1000-1500	N	B6-63	12L	6.3/60	17.6		
17DAP4	110	TA	15 5/8 x 12 3/4	10 1/4	900-1400	N	B7-208	8JK	2.68/45	17.6		
17DBP4	70	TA	15 7/8 x 12 3/4	19 1/4	750-1500	S	B6-63	12L	6.3/30	17.6		
17DCP4	90	TA	15 3/8 x 12 3/4	14 3/8	1000-1500	N	B6-63	12L	6.3/30	17.6		
17DEP4	110	TA	15 5/8 x 12 3/4	10 3/8	900-1400	N	B7-208	8JN	2.35/60	17.6		
17DHP4	110	TA	15 5/8 x 12 3/4	11 1/4	1000-1500	N	B7-208	8HR	6.3/45	17.6		
17DJP4	90	TA	15 3/8 x 12 3/4	15 3/8	1000-1500	S	B6-63	12L	6.3/30	17.6		
17DKP4	110	TA	15 5/8 x 12 3/4	10 1/4	1000-1500	N	B7-208	8JR	6.3/60	23		
17DLP4	110	TA	15 5/8 x 12 3/4	11 3/4	1000-1500	N	B6-226/B7-237	8JS	6.3/60	19.8		
17DQP4	110	TA	15 5/8 x 12 3/4	12 3/8	1200-1700	N	B6-214	7FA	6.3/45	17.6		
17DRP4	110	TA	15 5/8 x 12 3/4	10 3/8	900-1400	N	B7-208	8JK	2.68/45	17.6		
17DSP4	110	TA	15 5/8 x 12 3/4	11 1/4	1000-1500	N	B7-183	8HR	6.3/60	19.8		
17DTP4	110	TA	15 5/8 x 12 3/4	10 3/4	1000-1500	N	B7-208	8HR	6.3/60	22		
17DWP4	70	TA	15 3/8 x 12 3/4	19 1/4	750-1500	N	B6-63	12L	6.3/60	22		
17DXP4	110	TA	15 5/8 x 12 3/4	10 1/4	1000-1500	N	B7-208	8JR	6.3/45	17.6		
17DZP4	110	TA	15 5/8 x 12 3/4	10 1/4	1000-1500	N	B7-208	8HR	6.3/45	17.6		
17EAP4	70	TA	15 5/8 x 12 1/4	19 1/4	1000-1500	S	B5-57	12A2T	6.3/60	19.6		
17EBP4	110	TA	15 5/8 x 12 3/4	11 1/4	1100-1700	N	B7-208	8HR	6.3/45	20		
17EFP4	110	TA	15 5/8 x 12 3/4	11 1/4	1000-1500	N	B7-183	8HR	6.3/45	19.8		
17EHP4	110	TA	15 5/8 x 12 3/4	11 1/2	1000-1500	N	B7-208	8HR	6.3/60	20		
17EKP4	70	TA-BP	15 3/8 x 12 3/4	19 1/4	600-1000	N	B6-63	12L	6.3/60	22		
17ELP4	114	TA-BF	15 1/4 x 12 3/4	11 3/4	1150-1650	N	B7-208	8HR	6.3/45	15		
17EMP4	114	TA-BR	14 7/8 x 12 1/4	11 3/4	1300-1700	N	B7-208	8HR	6.3/45	22		
17EQP4	114	TA-BF	15 5/8 x 12 3/4	11 1/4	900-1500	N	B7-208	8HR	6.3/45	19.8		
17ESP4	114	TA-BR	14 7/8 x 11 3/4	11 1/4	1000-1400	N	B7-208	8HR	6.3/45	23		
17FP4	70	T	15 3/8 x 12 1/4	19 1/4	500-1500	S	B6-63	12L	6.3/60	19.8		
17FPA4	70	T	15 5/8 x 12 1/4	19 1/4	750-2000	S	B6-63	12L	6.3/60	19.8		
17GPA4	70	T, AR	15 3/8 x 12 1/4	19 1/4	750-1500	S	B6-63	12M	6.3/60	17.6		
17HP4	70	T	15 5/8 x 12 3/4	19 1/4	750-1500	S	B6-63	12L	6.3/60	17.6		
17HPA4	70	T, AR	15 5/8 x 12 3/4	19 1/4	750-1500	S	B6-63	12L	6.3/60	17.6		
17HPAB	70	TA	15 5/8 x 12 3/4	19 1/4	750-1500	S	B6-63	12L	6.3/60	17.6		
17HPAC	70	TA	15 5/8 x 12 3/4	19 1/4	750-1500	N	B6-63	12L	6.3/60	17.6		
17JPA4	70	T	15 5/8 x 12 3/4	19 1/4	500-1500	S	B5-57	12N	6.3/60	19.8		
17KPA4	70	T	15 3/8 x 12 1/4	19 1/4	1000-1500	S	B6-63	12P	6.3/60	17.6		
17KPA4	70	TA	15 3/8 x 12 1/4	19 1/4	1000-1500	S	B6-63	12P	6.3/60	17.6		
17LP4	70	T	15 3/8 x 12 1/4	19 1/4	750-1500	S	B6-63	12L	6.3/60	17.6		
17LPA4	70	TA	15 5/8 x 12 1/4	19 1/4	750-1500	S	B6-63	12L	6.3/60	17.6		
17LPAB	70	TA	15 5/8 x 12 1/4	19 1/4	750-1500	N	B6-63	12L	6.3/60	17.6		
17QPA4	70	T	15 3/8 x 12 1/4	19 1/4	750-1500	S	B5-57	12N	6.3/60	17.6		
17QPA4	70	TA	15 3/8 x 12 1/4	19 1/4	750-1500	S	B5-57	12N	6.3/60	19.8		
17QPAB	70	TA	15 5/8 x 12 1/4	19 1/4	750-1500	N	B5-57	12N	6.3/60	19.8		
17RP4	70	T	15 3/8 x 12 1/4	19 1/4	750-1500	S	B6-63	12L	6.3/60	17.6		
17RPAC	70	TA	15 5/8 x 12 1/4	19 1/4	750-1500	S	B6-63	12L	6.3/60	17.6		
17SPA4	70	T	15 3/8 x 12 1/4	19 1/4	500-750	S	B5-57	12N	6.3/60	15.4		
17TP4	70	T, AR	15 5/8 x 12 1/4	19 1/4	.....	S	B6-63	12M	6.3/60	17.6		
17UP4	70	T	15 3/8 x 12 1/4	19 1/4	750-1500	S	B5-57	12N	6.3/60	15.4		
17VP4	70	T	15 3/8 x 12 3/4	19 1/4	750-1500	S	B6-63	12L	6.3/60	17.6		
17VPAB	70	TA	15 5/8 x 12 3/4	19 1/4	750-1500	S	B6-63	12L	6.3/60	17.6		
17YPA4	70	T	15 5/8 x 12 3/4	19 1/4	500-1500	S	B5-57	12N	6.3/60	19.8		
19AP4	66	C	18 5/8	21 1/2	.....	S	B5-57	12D	6.3/60	17.6		
19AP4A	66	T	18 5/8	21 1/2	.....	S	B5-57	12D	6.3/60	17.6		
19AP4B	66	T, AR	18 5/8	21 1/2	.....	S	B5-57	12D	6.3/60	17.6		
19AP4C	66	TA	18 5/8	21 1/2	.....	S	B5-57	12D	6.3/60	17.6		
19AP4D	66	C, AR	18 5/8	21 1/2	.....	S	B5-57	12D	6.3/60	17.6		
19ABP4	114	TA	16 1/2 x 13 1/2	10 3/8	850-1400	N	B7-208	8JK	2.68/45	20		
19ACP4	114	TA	16 1/2 x 13 1/2	12 3/8	1000-1500	N	B7-208	8HR	6.3/60	20		
19AEP4	114	TA	16 5/8 x 13 1/2	11 3/8	1000-1500	N	B7-208	8HR	12.6/15	17.6		
19AFP4	114	BC, TA	17 1/4 x 14 3/4	11 3/8	1000-1500	N	B7-208	8HR	6.3/60	20		
19AHP4	114	TA	16 5/8 x 13 1/2	11 3/8	1000-1500	N	B7-208	8HR	6.3/45	17.6		
19AJP4	114	TA	16 5/8 x 13 1/2	11 3/8	1400-1900	N	B6-214	7FA	6.3/45	19.8		
19ALP4	114	TA	16 1/2 x 13 1/2	11 3/8	1000-1500	N	B7-208	8HR	6.3/30	22		
19ANP4	114	TA	16 1/2 x 13 1/2	10 3/8	1000-1500	N	B7-208	8JR	6.3/45	20		
19AQP4	114	TA	16 5/8 x 13 1/2	11 3/8	1000-1500	N	B7-208	8HR	6.3/30	20		
19ARP4	114	BC, TA	17 1/4 x 14 3/4	12 3/8	1000-1500	N	B7-208	8HR	6.3/60	20		
19ASP4	114	BC, TA	17 1/4 x 14 3/4	12 3/8	1000-1500	N	B7-208	8HR	6.3/30	20		

MAXIMUM RATINGS		TYPICAL OPERATION				REMARKS	Type
Focusing Electrode (Kv)	Accel. Grid (G2) Volts	Anode (Kv)	Focus Electrode Volts Magnet Coil Current in Ma.	Accel. Grid (G2) Volts	Negative Grid No. 1 or Positive Cathode Voltage for Raster Cutoff		
-55 to +1.1	550	14	-50 to +350	450	44-110	2.68 Volt Heater	17CZP4
-7 to +.95	550	14	+100 to +500	300	40-77		17DA4
-55 to +1.1	550	14	-50 to +300	300	40-77		17DBP4
-55 to +1.1	550	14	-50 to +300	300	40-77		17DCP4
+70	700	14	0 to 400	500	48-77	2.35 Volt Heater; Tri-Potential Focus	17DEP4
-55 to +1.1	770	14	0 to 400	500	48-77	Spherical Face Plate	17DHP4
-55 to +1.1	550	14	-50 to +300	300	40-77	Spherical Face Plate	17DJP4
+70	600	14	0 to 400	500	48-83	Tri-Potential Es. Focus; Spherical Face Plate	17DKP4
-55 to +1.1	770	17	0 to 400	450	33-77	Spherical Face Plate	17DLP4
-55 to +1.1	70	14.5	-200 to +350	50	+40 to +55*		17DQP4
-7 to +.95	550	14	+100 to +500	300	40-77	2.68 Volt Heater	17DRP4
-55 to +1.1	550	14	0 to 400	400	50-95		17DSP4
-55 to +1.1	550	14	0 to 400	300	33-77		17DTP4
+70	700	18	0 to 400	300	33-77		17DWP4
+70	600	14	0 to 400	500	48-83	Non-Potential Electrostatic Focus	17DXP4
-5 to +1.0	550	14	0 to 400	300	33-77		17DZP4
Auto. Es.	550	12	Auto. Es.	300	33-77		17EAP4
-55 to +1.1	700	14	0 to 400	500	48-77		17EBP4
-55 to +1.1	550	14	0 to 400	400	50-95		17EFP4
-50 to +1.1	60	16	0 to 400	50	35-55		17EHP4
-50 to +.80	700	18	0 to 400	300	33-77		17EKP4
-50 to +1.1	60	12	0 to 400	50	35-55		17ELP4
-40 to +1.25	60	16	0 to 400	50	33-45		17EMP4
-55 to +1.1	550	16	0 to 500	400	+35 to +72*		17QAP4
-55 to +1.1	550	16	-200 to +200	300	35-72		17ESP4
-5.5	450	16	+3100 to +4100	300	33-77	Metal Bulb	17FP4
-5.5	450	16	+3100 to +4100	300	33-77		17FPA4
-5.5	550	14	+2200 to +3620	300	33-77		17GP4
-55 to +1.1	550	14	-56 to +310	300	33-77		17HP4
-55 to +1.1	550	14	-56 to +310	300	33-77		17HPA4
-55 to +1.1	550	14	-56 to +310	300	33-77		17HPB4
-55 to +1.1	550	14	-56 to +310	300	33-77		17HPC4
Magnetic	450	14	100 Ma.	300	33-77		17JP4
Auto. Es.	550	12	Auto. Es.	300	33-77		17KP4
Auto. Es.	550	12	Auto. Es.	300	33-77		17KPA4
-55 to +1.1	550	14	-56 to +310	300	33-77	Cylindrical Faceplate	17LP4
-55 to +1.1	550	14	-56 to +310	300	33-77		17LPA4
-55 to +1.1	550	14	-56 to +310	300	33-77		17LPB4
Magnetic	450	12	100 Ma.	300	33-77		17QPA4
Magnetic	450	14	95 Ma.	300	33-77		17QPA4
Magnetic	450	14	95 Ma.	300	33-77	Cylindrical Faceplate	17QP4B
-55 to +1.1	550	14	-50 to +350	300	33-77		17RP4
-55 to +1.1	550	14	-50 to +350	300	33-77		17RPA4
Auto. Es.	450	12	Auto. Es.	250	33-66		Cylindrical Faceplate
-55 to +1.1	550	16	-65 to +350	300	33-77	Metal Bulb	17TP4
Magnetic	450	13	110 Ma.	250	33-66	Cylindrical Faceplate	17UP4
-55 to +1.1	550	14	-48 to +260	300	33-77		17VPA4
-55 to +1.1	550	14	-48 to +260	300	33-77		17VPB4
Magnetic	550	16	100 Ma.	300	33-77		17YP4
Magnetic	450	12	140 Ma.	300	33-77		19AP4
Magnetic	450	12	140 Ma.	300	33-77	Metal Bulb	19AP4A
Magnetic	450	12	140 Ma.	300	33-77		19AP4B
Magnetic	450	12	140 Ma.	300	33-77		19AP4C
Magnetic	450	12	140 Ma.	300	33-77		19AP4D
-7 to +.95	550	16	100 to 500	300	40-77	2.68 Volt Heater	19ABP4
-55 to +1.1	70	14	0 to 400	50	+40 to +55*		19ACP4
-50 to +.50	250	14	-100 to +100	100	32-47		19AEP4
-55 to +1.1	550	16	0 to 400	300	40-77		19AFP4
-55 to +1.1	650	14	0 to 400	500	+45 to +68*		19AHP4
-50 to +1.1	70	14.5	250	50	+36 to +54*		19AJ4
-55 to +1.1	700	14	0 to 400	500	+50 to +100*	18 Sec. Heater Warm-up Time Tri-Potential Electrostatic Focus	19ALP4
-35 to +.7	600	16	0 to 400	500	48-83		19ANP4
-50 to +1.0	550	16	0 to 400	300	38-72		19AQP4
-55 to +1.1	550	16	0 to 400	300	40-77		19ARP4
-55 to +1.1	550	16	0 to 400	300	40-77		19ASP4

# Monochrome TV Picture Tubes Data (cont'd)

Type	Defl. Angle and Neck Dia. †	FACEPLATE		OVERALL DIMENSIONS INCHES		External Conductive Coating Capacitance (pf)	** Ion Trap	Base	Basing	Heater▲ Volts/ Amps	Anode (Kv)	DES
		Clear Tinted Alum. Shield* Anti-Refll.		Faceplate Dimensions	Length							
19ATP4	114	BC, TA		17 <sup>1</sup> / <sub>2</sub> x 14 <sup>1</sup> / <sub>2</sub>	11 <sup>1</sup> / <sub>2</sub>	1000-1500	N	B7-208	8JR	6.3/60	20	
19AUP4	114	BC, TA, AR		17 <sup>1</sup> / <sub>2</sub> x 14 <sup>1</sup> / <sub>2</sub>	11 <sup>1</sup> / <sub>2</sub>	1000-1500	N	B7-208	8HR	6.3/60	20	
19AVP4	114	TA		16 <sup>1</sup> / <sub>2</sub> x 13 <sup>1</sup> / <sub>2</sub>	11 <sup>1</sup> / <sub>2</sub>	1000-1500	N	B7-208	8HR	6.3/60	23	
19AXP4	114	TA		16 <sup>1</sup> / <sub>2</sub> x 13 <sup>1</sup> / <sub>2</sub>	11 <sup>1</sup> / <sub>2</sub>	1000-1500	N	B7-208	8HR	6.3/45	20	
19AYP4	114	TA		16 <sup>1</sup> / <sub>2</sub> x 13 <sup>1</sup> / <sub>2</sub>	11 <sup>1</sup> / <sub>2</sub>	1000-1500	N	B7-208	8HR	6.3/45	23	
19BAP4	114	BC, TA		17 <sup>1</sup> / <sub>2</sub> x 14 <sup>1</sup> / <sub>2</sub>	11 <sup>1</sup> / <sub>2</sub>	1000-1500	N	B7-208	8HR	6.3/30	20	
19BCP4	114	BC, TA, AR		17 <sup>1</sup> / <sub>2</sub> x 14 <sup>1</sup> / <sub>2</sub>	11 <sup>1</sup> / <sub>2</sub>	1000-1500	N	B7-208	8HR	6.3/30	20	
19BDP4	92	TA		16 <sup>1</sup> / <sub>2</sub> x 13 <sup>1</sup> / <sub>2</sub>	15 <sup>1</sup> / <sub>2</sub>	1500-2000	N	B6-63/B6-203	12L	6.3/60	20	
19BEP4	110	TA		16 <sup>1</sup> / <sub>2</sub> x 13 <sup>1</sup> / <sub>2</sub>	11 <sup>1</sup> / <sub>2</sub>	1000-1500	N	B7-208	8HR	6.3/30	20	
19BFP4	92	TA		16 <sup>1</sup> / <sub>2</sub> x 13 <sup>1</sup> / <sub>2</sub>	15 <sup>1</sup> / <sub>2</sub>	1500-2000	N	B6-203	12L	6.3/60	20	
19BHP4	114	TA		16 <sup>1</sup> / <sub>2</sub> x 13 <sup>1</sup> / <sub>2</sub>	11 <sup>1</sup> / <sub>2</sub>	1000-1500	N	B7-237/B7-208	8HR	6.3/60	22	
19BLP4	114	TA		16 <sup>1</sup> / <sub>2</sub> x 13 <sup>1</sup> / <sub>2</sub>	11 <sup>1</sup> / <sub>2</sub>	1300-1700	N	B7-208	8HR	6.3/60	20	
19BMP4	114	BC, TA		17 <sup>1</sup> / <sub>2</sub> x 14 <sup>1</sup> / <sub>2</sub>	11 <sup>1</sup> / <sub>2</sub>	1300-1700	N	B7-208	8HR	6.3/60	20	
19BNP4	114	BC, TA		17 <sup>1</sup> / <sub>2</sub> x 14 <sup>1</sup> / <sub>2</sub>	12 <sup>1</sup> / <sub>2</sub>	1000-1500	N	B7-208	8HR	6.3/60	20	
19BQP4	114	BC, TA, AR		17 <sup>1</sup> / <sub>2</sub> x 14 <sup>1</sup> / <sub>2</sub>	12 <sup>1</sup> / <sub>2</sub>	1000-1500	N	B7-208	8HR	6.3/60	20	
19BRP4	114	TA-BP		16 <sup>1</sup> / <sub>2</sub> x 13 <sup>1</sup> / <sub>2</sub>	11 <sup>1</sup> / <sub>2</sub>	1500-2000	N	B7-208	8HR	6.3/60	23	
19BSP4	110	TA		16 <sup>1</sup> / <sub>2</sub> x 13 <sup>1</sup> / <sub>2</sub>	11 <sup>1</sup> / <sub>2</sub>	1000-1500	N	B7-208	8HR	6.3/60	20	
19BTP4	114	TA		16 <sup>1</sup> / <sub>2</sub> x 13 <sup>1</sup> / <sub>2</sub>	10 <sup>1</sup> / <sub>2</sub>	1000-1500	N	B7-208	8JR	6.3/60	23	
19BUP4	114	TA		16 <sup>1</sup> / <sub>2</sub> x 13 <sup>1</sup> / <sub>2</sub>	11 <sup>1</sup> / <sub>2</sub>	1300-1700	N	B7-208	8HR	2.2/102	18.75	
19BVP4	114	TA		16 <sup>1</sup> / <sub>2</sub> x 13 <sup>1</sup> / <sub>2</sub>	11 <sup>1</sup> / <sub>2</sub>	1000-1500	N	B7-208	8HR	6.3/60	23.5	
19BWP4	114	TA		16 <sup>1</sup> / <sub>2</sub> x 13 <sup>1</sup> / <sub>2</sub>	11 <sup>1</sup> / <sub>2</sub>	1000-1500	N	B7-208	8HR	6.3/45	20	
19CAP4	110	TA		16 <sup>1</sup> / <sub>2</sub> x 13 <sup>1</sup> / <sub>2</sub>	11 <sup>1</sup> / <sub>2</sub>	1000-1500	N	B7-208	8JR	6.3/60	20	
19CDP4	114	TA		16 <sup>1</sup> / <sub>2</sub> x 13 <sup>1</sup> / <sub>2</sub>	11 <sup>1</sup> / <sub>2</sub>	1400-1900	N	B6-214	7FA	6.3/60	19.8	
19CEP4	114	BC, TA, AR		17 <sup>1</sup> / <sub>2</sub> x 14 <sup>1</sup> / <sub>2</sub>	11 <sup>1</sup> / <sub>2</sub>	1000-1500	N	B7-208	8HR	6.3/30	20	
19CFP4	114	TA		16 <sup>1</sup> / <sub>2</sub> x 13 <sup>1</sup> / <sub>2</sub>	11 <sup>1</sup> / <sub>2</sub>	1000-1500	N	B7-237/B7-208	8HR	6.3/60	17.5	
19CGP4	92	BC, TA, AR		17 <sup>1</sup> / <sub>2</sub> x 15 <sup>1</sup> / <sub>2</sub>	15 <sup>1</sup> / <sub>2</sub>	1400-1700	N	B6-203	12L	6.3/60	20	
19CHP4	114	TA		16 <sup>1</sup> / <sub>2</sub> x 13 <sup>1</sup> / <sub>2</sub>	11 <sup>1</sup> / <sub>2</sub>	1000-1500	N	B7-208	8HR	6.3/60	20	
19CJP4	114	TA		16 <sup>1</sup> / <sub>2</sub> x 13 <sup>1</sup> / <sub>2</sub>	11 <sup>1</sup> / <sub>2</sub>	1300-1700	N	B7-208	8HR	6.3/60	20	
19CKP4	114	TA		16 <sup>1</sup> / <sub>2</sub> x 13 <sup>1</sup> / <sub>2</sub>	11 <sup>1</sup> / <sub>2</sub>	1000-1500	N	B7-237/B7-208	8HR	6.3/60	22	
19CLP4	92	TA		16 <sup>1</sup> / <sub>2</sub> x 13 <sup>1</sup> / <sub>2</sub>	15 <sup>1</sup> / <sub>2</sub>	1500-2000	N	B6-203	12L	6.3/60	19.8	
19CMP4	114	TA		16 <sup>1</sup> / <sub>2</sub> x 13 <sup>1</sup> / <sub>2</sub>	11 <sup>1</sup> / <sub>2</sub>	1000-1500	N	B7-208	8HR	6.3/45	20	
19CMP4A	114	TA		16 <sup>1</sup> / <sub>2</sub> x 13 <sup>1</sup> / <sub>2</sub>	11 <sup>1</sup> / <sub>2</sub>	1000-1500	N	B7-208	8HR	6.3/45	23.5	
19CQP4	114	TA		16 <sup>1</sup> / <sub>2</sub> x 13 <sup>1</sup> / <sub>2</sub>	11 <sup>1</sup> / <sub>2</sub>	1400-1900	N	B6-214	7FA	6.3/60	19.8	
19CRP4	92	TA		16 <sup>1</sup> / <sub>2</sub> x 13 <sup>1</sup> / <sub>2</sub>	15 <sup>1</sup> / <sub>2</sub>	1500-2000	N	B6-203	12L	6.3/60	22	
19CUP4	114	TA		16 <sup>1</sup> / <sub>2</sub> x 13 <sup>1</sup> / <sub>2</sub>	11 <sup>1</sup> / <sub>2</sub>	1300-1700	N	B7-208	8HR	6.3/45	22	
19CVP4	114	TA-BC		17 <sup>1</sup> / <sub>2</sub> x 14 <sup>1</sup> / <sub>2</sub>	11 <sup>1</sup> / <sub>2</sub>	1700-2100	N	B7-208	8HR	6.3/45	23	
19CXp4	114	TA		16 <sup>1</sup> / <sub>2</sub> x 13 <sup>1</sup> / <sub>2</sub>	11 <sup>1</sup> / <sub>2</sub>	1400-1900	N	B6-214	7FA	6.3/60	19.8	
19CYP4	114	TA		16 <sup>1</sup> / <sub>2</sub> x 13 <sup>1</sup> / <sub>2</sub>	10 <sup>1</sup> / <sub>2</sub>	1000-1500	N	B7-208	8HR	6.3/60	23	
19CZP4	114	TA-BP		16 <sup>1</sup> / <sub>2</sub> x 13 <sup>1</sup> / <sub>2</sub>	11 <sup>1</sup> / <sub>2</sub>	1000-1500	N	B7-208	8HR	6.3/45	23	
19DP4	66	C		18 <sup>1</sup> / <sub>2</sub>	21 <sup>1</sup> / <sub>2</sub>	750-2500	S	B5-57	12N	6.3/60	18.7	
19DP4A	66	T		18 <sup>1</sup> / <sub>2</sub>	21 <sup>1</sup> / <sub>2</sub>	750-2500	S	B5-57	12N	6.3/60	18.7	
19DAP4	114	TA-AR-BP		16 <sup>1</sup> / <sub>2</sub> x 13 <sup>1</sup> / <sub>2</sub>	11 <sup>1</sup> / <sub>2</sub>	1000-1500	N	B7-208	8HR	6.3/45	23	
19DBP4	114	TA-BP		16 <sup>1</sup> / <sub>2</sub> x 13 <sup>1</sup> / <sub>2</sub>	11 <sup>1</sup> / <sub>2</sub>	1400-1900	N	B6-214	7FA	6.3/45	19.8	
19DCP4	114	TA-BR		16 <sup>1</sup> / <sub>2</sub> x 13 <sup>1</sup> / <sub>2</sub>	11 <sup>1</sup> / <sub>2</sub>	1000-1500	N	B7-208	8HR	6.3/60	20	
19DEP4	114	TA		16 <sup>1</sup> / <sub>2</sub> x 13 <sup>1</sup> / <sub>2</sub>	11 <sup>1</sup> / <sub>2</sub>	1000-1500	N	B7-237/B7-208	8HR	6.3/60	22	
19DFP4	114	TA		16 <sup>1</sup> / <sub>2</sub> x 13 <sup>1</sup> / <sub>2</sub>	11 <sup>1</sup> / <sub>2</sub>	1300-1700	N	B7-208	8HR	6.3/60	22	
19DHP4	114	TA-BR		16 <sup>1</sup> / <sub>2</sub> x 13 <sup>1</sup> / <sub>2</sub>	11 <sup>1</sup> / <sub>2</sub>	1000-1500	N	B7-208	8HR	6.3/60	20	
19DJP4	110	TA		16 <sup>1</sup> / <sub>2</sub> x 13 <sup>1</sup> / <sub>2</sub>	11 <sup>1</sup> / <sub>2</sub>	1000-1500	N	B7-208	8HR	6.3/30	20	
19DKP4	114	TA-BP		16 <sup>1</sup> / <sub>2</sub> x 13 <sup>1</sup> / <sub>2</sub>	11 <sup>1</sup> / <sub>2</sub>	1000-1500	N	B7-208	8HR	6.3/60	23	
19DLP4	114	TA		16 <sup>1</sup> / <sub>2</sub> x 13 <sup>1</sup> / <sub>2</sub>	11 <sup>1</sup> / <sub>2</sub>	1000-1500	N	B7-208	8HR	6.3/60	20	
19DNP4	114	TA-BP		16 <sup>1</sup> / <sub>2</sub> x 13 <sup>1</sup> / <sub>2</sub>	11 <sup>1</sup> / <sub>2</sub>	1000-1500	N	B7-208	8HR	6.3/60	18	
19DQP4	114	TA-BR		16 <sup>1</sup> / <sub>2</sub> x 13 <sup>1</sup> / <sub>2</sub>	11 <sup>1</sup> / <sub>2</sub>	1000-1500	N	B7-208	8HR	6.3/45	23	
19DRP4	114	TA-BR		16 <sup>1</sup> / <sub>2</sub> x 13 <sup>1</sup> / <sub>2</sub>	11 <sup>1</sup> / <sub>2</sub>	1250-1750	N	B7-208	8HR	6.3/60	23	
19DSP4	114	TA-BR		16 <sup>1</sup> / <sub>2</sub> x 13 <sup>1</sup> / <sub>2</sub>	11 <sup>1</sup> / <sub>2</sub>	1000-1500	N	B7-208	8HR	6.3/60	20	
19DUP4	114	TA-BR		16 <sup>1</sup> / <sub>2</sub> x 13 <sup>1</sup> / <sub>2</sub>	11 <sup>1</sup> / <sub>2</sub>	1150-1550	N	B7-208	8HR	6.3/45	22	
19DVP4	114	TA		16 <sup>1</sup> / <sub>2</sub> x 13 <sup>1</sup> / <sub>2</sub>	11 <sup>1</sup> / <sub>2</sub>	1000-1500	N	B7-237/B7-208	8HR	6.3/45	20	
19DWP4	114	TA-BR		16 <sup>1</sup> / <sub>2</sub> x 13 <sup>1</sup> / <sub>2</sub>	11 <sup>1</sup> / <sub>2</sub>	1000-1500	N	B7-208	8HR	6.3/45	23	
19DYP4	114	TA-BC		17 <sup>1</sup> / <sub>2</sub> x 14 <sup>1</sup> / <sub>2</sub>	11 <sup>1</sup> / <sub>2</sub>	1700-2100	N	B7-208	8HR	6.3/45	23	
19DZP4	114	TA		16 <sup>1</sup> / <sub>2</sub> x 13 <sup>1</sup> / <sub>2</sub>	11 <sup>1</sup> / <sub>2</sub>	1000-1500	N	B7-237/B7-208	8HR	6.3/45	18	
19EP4	70	T		17 x 13 <sup>1</sup> / <sub>2</sub>	21 <sup>1</sup> / <sub>2</sub>	.....	N	B5-57	12D	6.3/60	20.9	



MAXIMUM RATINGS		TYPICAL OPERATION				REMARKS	Type
Focusing Electrode (Kv)	Accel. Grid (G2) Volts	Anode (Kv)	Focus Electrode Volts Magnet Coil Current in Ma.	Accel. Grid (G2) Volts	Negative Grid No. 1 or Positive Cathode Voltage for Raster Cutoff		
+ .70	600	16	0 to 400	500	48-83	Tri-Potential Electrostatic Focus	19ATP4
- .55 to +1.1	550	16	0 to 400	300	40-77		19AUP4
- .55 to +1.1	550	20	0 to 400	400	41-99		19AVP4
- .55 to +1.1	550	16	0 to 400	400	41-99		19AXP4
- .55 to +1.1	550	20	0 to 400	400	41-99		19AYP4
- .55 to +1.1	550	16	0 to 400	300	40-77	19BP4	19BP4
- .55 to +1.1	550	16	0 to 400	300	40-77		19BCP4
- .40 to +1.25	225	14.5	250	50	+36 to +54*		19BDP4
- .55 to +1.1	550	16	0 to 400	400	42-78		19BEP4
- .55 to +1.1	550	16	0 to 400	400	41-99		19BFP4
- .55 to +1.1	700	18.5	0 to 500	450	33-66	19BHP4	19BHP4
- .55 to +1.1	550	16	0 to 400	400	41-99		19BLP4
- .55 to +1.1	550	16	0 to 400	400	41-99		19BMP4
- .55 to +1.1	70	16	0 to 400	50	+37 to +55*		19BNP4
- .55 to +1.1	70	16	0 to 400	50	+37 to +55*		19BQP4
- .55 to +1.1	550	16	0 to 400	300	35-72	Tri-Potential Electrostatic Focus	19BRP4
- .55 to +1.1	550	16	0 to 400	400	42-78		19BSP4
- .35 to +.70	600	16	0 to 400	500	48-83		19BTP4
- .20 to +.50	250	14	0 to 400	100	45-60		19BUP4
- .55 to +1.1	700	20	250	500	+50 to +100*		19BVP4
- .55 to +1.1	700	20	250	500	+50 to +100*	Tri-Potential Electrostatic Focus	19BWP4
- .35 to +.70	600	16	0 to 400	500	48-83		19CAP4
- .50 to +1.1	70	16	0 to 500	50	35-50		19CDP4
- .55 to +1.1	550	16	0 to 400	300	40-77		19CEP4
- .50 to +1.0	100	13	0	50	31-49		19CFP4
- .55 to +1.1	550	16	0 to 400	300	40-77	18 Second Heater Warm-up Time	19CGP4
- .40 to +1.25	70	16	0 to 400	50	32-50		19CHP4
- .55 to +1.1	550	16	0 to 400	400	65-105		19CJP4
- .50 to +1.0	100	18	0 to 500	50	31-49		19CKP4
- .50 to +1.1	40	14.5	0 to 500	35	25-40		19CLP4
- .55 to +1.1	60	16	0 to 400	30	30-45	19CMP4	
- .55 to +1.1	60	16	0 to 400	30	30-45	19CMP4A	
- .50 to +1.1	60	16	0 to 500	50	25-50	19CQP4	
- .50 to +1.1	60	16	0 to 500	35	25-50	19CRP4	
- .55 to +1.1	80	16	-100 to +300	65	41-56	19CUP4	
- .40 to +1.25	70	16	0 to 400	50	32-50	19CVP4	
- .50 to +1.1	55	16	0 to 500	45	35-50	19CXP4	
- .50 to +1.0	550	20	0 to 400	400	36-94	19CYP4	
- .55 to +1.1	550	20	0 to 400	400	42-78	19CZP4	
Magnetic	450	13	146 Ma.	250	26-63	19DP4	
Magnetic	450	13	146 Ma.	250	26-63	19DP4A	
- .55 to +1.1	550	20	0 to 400	400	42-78	19DAP4	
- .50 to +1.1	60	16	0 to 500	40	35-50	19DBP4	
- .50 to +1.0	550	16	0 to 400	400	39-94	19DCP4	
- .50 to +1.0	500	18	0 to 500	300	36-54	19DEP4	
- .55 to +1.1	80	16	-100 to +300	65	41-56	19DFP4	
- .50 to +1.1	60	16	250	50	35-55	19DHP4	
- .55 to +1.1	700	16	0 to 400	400	+42 to +78*	16 Second Heater Warm-up Time	19DJP4
- .55 to +1.1	550	20	0 to 400	400	46-94		19DKP4
- .50 to +1.1	60	16	250	50	35-55		19DLP4
- .55 to +1.1	550	16	0 to 400	300	35-72		19DNP4
- .55 to +1.1	550	16	-100 to +300	300	28-62		19DQP4
- .55 to +1.1	550	16	-100 to +300	300	28-62	19DRP4	
- .40 to +1.25	70	16	-100 to +300	50	32-50	19DSP4	
- .55 to +1.1	60	16	-200 to +200	50	33-45	19DUP4	
- .50 to +1.0	250	16	-250 to +150	150	36-54	19DVP4	
- .55 to +1.1	550	20	-200 to +200	400	50-98	19DWP4	
- .40 to +1.25	70	16	0 to 400	50	32-50	19DYP4	
- .50 to +1.0	250	13	-250 to +150	150	36-54	19DZP4	
Magnetic	450	13	146 Ma.	250	26-63	19EP4	

## Monochrome TV Picture Tubes Data (cont'd)

Type	Defl. Angle and Neck Dia. ♦	FACEPLATE		OVERALL DIMENSIONS INCHES		External Conductive Coating Capacitance (pf)	** Ion Trap	Base	Basing	Heater▲ Volts/Amps	DESIGN	
		Clear Tinted Alum. Shield* Anti-Refll.		Faceplate Dimensions	Length						Anode (Kv)	
19EAP4	114	TA-BR		16 $\frac{1}{2}$ x 13 $\frac{1}{2}$	11 $\frac{1}{8}$	1000-1500	N	B7-208	8HR	6.3/.45		20
19EBP4	114	TA-BF		17 $\frac{1}{8}$ x 14 $\frac{1}{4}$	11 $\frac{3}{8}$	1000-1500	N	B7-208	8HR	6.3/.60		23
19ECP4	114	TA		16 $\frac{1}{2}$ x 13 $\frac{1}{2}$	11 $\frac{3}{8}$	1000-1500	N	B7-237/ B7-208	8HR	6.3/.45		20
19EDP4	114	TA-BR		16 $\frac{1}{2}$ x 13 $\frac{1}{2}$	11 $\frac{3}{8}$	1000-1500	N	B7-208	8HR	6.3/.60		23
19EFP4	114	TA-BR		16 $\frac{1}{2}$ x 13 $\frac{1}{2}$	11 $\frac{3}{8}$	1000-1500	N	B7-208	8HR	6.3/.60		20
19EGP4	114	TA-BF		17 $\frac{1}{8}$ x 14 $\frac{1}{4}$	11 $\frac{3}{8}$	1000-1500	N	B7-208	8HR	6.3/.45		21
19EHP4	114	TA-BR		16 $\frac{1}{2}$ x 13 $\frac{1}{2}$	11 $\frac{3}{8}$	1000-1500	N	B7-208	8HR	6.3/.60		18
19EHP4A	114	TA-BR		16 $\frac{1}{2}$ x 13 $\frac{1}{2}$	11 $\frac{3}{8}$	1000-1500	N	B7-208	8HR	6.3/.60		18
19EJP4	114	TA-BR		16 $\frac{1}{2}$ x 13 $\frac{1}{2}$	11 $\frac{3}{8}$	1000-1500	N	B7-208	8HR	6.3/.45		20
19EKP4	114	TA-BF		17 $\frac{1}{8}$ x 14 $\frac{1}{4}$	11 $\frac{3}{8}$	1000-1500	N	B6-214	7FA	6.3/.45		19.8
19ELP4	114	TA		16 $\frac{1}{2}$ x 13 $\frac{1}{2}$	11 $\frac{3}{8}$	1000-1500	N	B7-208	8HR	6.3/.60		18
19ENP4	114	TA-BR		16 $\frac{1}{2}$ x 13 $\frac{1}{2}$	11 $\frac{3}{8}$	1000-1500	N	B7-208	8HR	6.3/.45		21
19ENP4A	114	TA-BR		16 $\frac{1}{2}$ x 13 $\frac{1}{2}$	11 $\frac{3}{8}$	1000-1500	N	B7-208	8HR	6.3/.45		21
19ESP4	114	TA-BR		16 $\frac{1}{2}$ x 13 $\frac{1}{2}$	11 $\frac{3}{8}$	1000-1500	N	B7-208	8HR	6.3/.60		20
19ETP4	114	TA-BR		16 $\frac{1}{2}$ x 13 $\frac{1}{2}$	11 $\frac{3}{8}$	1000-1500	N	B7-208	8HR	6.3/.45		21
19EUP4	114	TA-BR		16 $\frac{1}{2}$ x 13 $\frac{1}{2}$	11 $\frac{3}{8}$	1000-1500	N	B7-208	8HR	6.3/.60		23
19EZP4	114	TA-BF		16 $\frac{1}{2}$ x 13 $\frac{1}{2}$	11 $\frac{3}{8}$	1000-1500	N	B6-214	7FA	6.3/.45		19.8
19FP4	66	T		18 $\frac{1}{8}$	22		D	B5-57	12D	6.3/.60		20.9
19FBP4	114	TA-BF		17 $\frac{1}{8}$ x 14 $\frac{1}{4}$	11 $\frac{3}{8}$	1000-1500	N	B7-208	8HR	6.3/.45		15
19FCP4	114	TA-BR		16 $\frac{1}{2}$ x 13 $\frac{1}{2}$	11 $\frac{3}{8}$	1000-1500	N	B7-208	8HR	6.3/.45		23
19FEP4	114	TA-BR		16 $\frac{1}{2}$ x 13 $\frac{1}{2}$	11 $\frac{3}{8}$	1250-1750	N	B7-208	8HR	6.3/.45		20
19FEP4A	114	TA-BR		16 $\frac{1}{2}$ x 13 $\frac{1}{2}$	11 $\frac{3}{8}$	1250-1750	N	B7-208	8HR	6.3/.45		23.5
19FEP4B	114	TA-TB		16 $\frac{1}{2}$ x 13 $\frac{1}{2}$	11 $\frac{3}{8}$	1000-1500	N	B7-208	8HR	6.3/.45		23.5
19FGP4	114	TA-BR		16 $\frac{1}{2}$ x 13 $\frac{1}{2}$	10 $\frac{3}{4}$	1000-1500	N	B7-208	8HR	6.3/.60		20
19FHP4	114	TA-BR		16 $\frac{1}{2}$ x 13 $\frac{1}{2}$	11 $\frac{3}{8}$	1000-1500	N	B7-208	8HR	6.3/.60		21
19FJP4	114	TA-BR		16 $\frac{1}{2}$ x 13 $\frac{1}{2}$	11 $\frac{3}{8}$	1000-1500	N	B7-208	8HR	6.3/.45		18
19FJP4A	114	TA-BR		16 $\frac{1}{2}$ x 13 $\frac{1}{2}$	11 $\frac{3}{8}$	1250-1750	N	B7-208	8HR	6.3/.45		18
19FKP4	110	TA-BF		17 $\frac{1}{8}$ x 14 $\frac{1}{4}$	11 $\frac{3}{8}$	1000-1500	N	B7-208	8HR	6.3/.30		20
19FLP4	114	TA-BR		16 $\frac{1}{2}$ x 13 $\frac{1}{2}$	11 $\frac{3}{8}$	1250-1750	N	B7-208	8HR	6.3/.45		23
19FNP4	114	TA-BR		16 $\frac{1}{2}$ x 13 $\frac{1}{2}$	11 $\frac{3}{8}$	1250-1750	N	B7-208	8HR	6.3/.60		23
19FRP4	114	TA-BR		16 $\frac{1}{2}$ x 13 $\frac{1}{2}$	11 $\frac{3}{8}$	1250-1750	N	B7-208	8HR	6.3/.30		23
19FTP4	114	TA-BR		16 $\frac{1}{2}$ x 13 $\frac{1}{2}$	11 $\frac{1}{2}$	1000-1500	N	B7-208	8HR	6.3/.45		21
19FWP4	114	TA		16 $\frac{1}{2}$ x 13 $\frac{1}{2}$	11 $\frac{3}{8}$	1000-1500	N	B7-208	8HR	4.2/.45		20
19FZP4	110	TA-BP		16 $\frac{1}{2}$ x 13 $\frac{1}{2}$	11 $\frac{3}{4}$	1000-1500	N	B7-208	8HR	6.3/.30		20
19GAP4	114	TA-BF		16 $\frac{1}{2}$ x 13 $\frac{1}{2}$	11 $\frac{3}{8}$	1000-1500	N	B7-208	8HR	6.3/.45		19.8
19GBP4	114	TA-BP		16 $\frac{1}{2}$ x 13 $\frac{1}{2}$	11 $\frac{3}{8}$	1000-1500	N	B7-208	8HR	6.3/.45		23
19GEP4	114	TA-BR		16 $\frac{1}{2}$ x 13 $\frac{1}{2}$	11 $\frac{3}{8}$	1250-1750	N	B7-208	8HR	6.3/.45		23
19GEP4A	114	TA-BR		16 $\frac{1}{2}$ x 13 $\frac{1}{2}$	11 $\frac{3}{8}$	1250-1750	N	B7-208	8HR	6.3/.45		23
19GHP4	114	TA-BR		16 $\frac{1}{2}$ x 13 $\frac{1}{2}$	11 $\frac{3}{8}$	1150-1550	N	B7-208	8HR	6.3/.45		22
19GJP4	114	TA-BR		16 $\frac{1}{2}$ x 13 $\frac{1}{2}$	11 $\frac{3}{8}$	1000-1500	N	B7-208	8HR	6.3/.45		23
19GJP4A	114	TA-BR		16 $\frac{1}{2}$ x 13 $\frac{1}{2}$	11 $\frac{3}{8}$	1000-1500	N	B7-208	8HR	6.3/.45		23
19GKP4	114	TA-BR		16 $\frac{1}{2}$ x 13 $\frac{1}{2}$	11 $\frac{3}{8}$	1250-1750	N	B7-208	8HR	6.3/.30		23
19GMP4	114	TA-BP		17 $\frac{1}{8}$ x 14 $\frac{1}{4}$	11 $\frac{3}{8}$	700-900	N	B7-208	8HR	6.3/.45		23
19HAP4	114	TA-BF		17 $\frac{1}{8}$ x 14 $\frac{1}{4}$	11 $\frac{3}{8}$	1000-1500	N	B7-208	8HR	6.3/.315		21
19HGP4	114	TA-BR		16 $\frac{1}{2}$ x 13 $\frac{1}{2}$	11 $\frac{3}{8}$	1000-1700	N	B7-208	8HR	6.3/.45		20
19XP4	114	TA		16 $\frac{1}{2}$ x 13 $\frac{1}{2}$	11 $\frac{3}{8}$	1000-1500	N	B7-208	8HR	6.3/.60		20
19YP4	114	TA		16 $\frac{1}{2}$ x 13 $\frac{1}{2}$	10 $\frac{3}{4}$	1000-1500	N	B7-208	8JR	6.3/.60		20
19ZP4	114	TA		16 $\frac{1}{2}$ x 13 $\frac{1}{2}$	11 $\frac{1}{2}$	700-1500	N	B6-226/B7-237	8JS	6.3/.60		20
20ABP4	114	TA-BR		16 $\frac{1}{2}$ x 13 $\frac{1}{2}$	12 $\frac{1}{4}$	700-900	N	B7-208	8HR	6.3/.45		23
20ADP4	114	TA-TB		16 $\frac{1}{2}$ x 13 $\frac{1}{2}$	12 $\frac{1}{4}$	1500-2000	N	B7-208	8HR	6.3/.45		23
20AEP4	114	TA-TB		16 $\frac{1}{2}$ x 13 $\frac{1}{2}$	12 $\frac{1}{4}$	1500-2200	N	B7-208	8HR	6.3/.45		23.5
20CP4	70	T		18 $\frac{1}{8}$ x 14 $\frac{1}{4}$	21 $\frac{3}{4}$	.....	S	B5-57	12D	6.3/.60		19.8
20CP4A	70	T		18 $\frac{1}{8}$ x 14 $\frac{1}{4}$	21 $\frac{3}{4}$	500-1500	S	B5-57	12N	6.3/.60		19.8
20CP4B	70	TA		18 $\frac{1}{8}$ x 14 $\frac{1}{4}$	21 $\frac{3}{4}$	.....	S	B5-57	12D	6.3/.60		19.8
20CP4C	70	T, AR		18 $\frac{1}{8}$ x 14 $\frac{1}{4}$	21 $\frac{3}{4}$	.....	S	B5-57	12D	6.3/.60		19.8
20CP4D	70	TA		18 $\frac{1}{8}$ x 14 $\frac{1}{4}$	21 $\frac{3}{4}$	500-1500	S	B5-57	12N	6.3/.60		19.8
20DP4	70	T		18 $\frac{1}{8}$ x 14 $\frac{1}{4}$	21 $\frac{3}{4}$	.....	S	B5-57	12D	6.3/.60		19.8
20DP4A	70	T		18 $\frac{1}{8}$ x 14 $\frac{1}{4}$	21 $\frac{3}{4}$	500-1500	S	B5-57	12N	6.3/.60		19.8
20DP4B	70	TA		18 $\frac{1}{8}$ x 14 $\frac{1}{4}$	21 $\frac{3}{4}$	.....	S	B5-57	12D	6.3/.60		19.8
20DP4C	70	TA		18 $\frac{1}{8}$ x 14 $\frac{1}{4}$	21 $\frac{3}{4}$	500-1500	S	B5-57	12N	6.3/.60		19.8
20DP4D	70	TA		18 $\frac{1}{8}$ x 14 $\frac{1}{4}$	21 $\frac{3}{4}$	500-1500	N	B5-57	12N	6.3/.60		19.8
20FP4	70	T		18 $\frac{1}{8}$ x 14 $\frac{1}{4}$	21 $\frac{3}{4}$	.....	S	B6-63	12M	6.3/.60		19.8
20GP4	70	T		18 $\frac{1}{8}$ x 14 $\frac{1}{4}$	21 $\frac{3}{4}$	500-750	S	B6-63	12L	6.3/.60		19.8
20HP4	70	T		18 $\frac{1}{8}$ x 14 $\frac{1}{4}$	21 $\frac{3}{4}$	.....	S	B6-63/B6-203	12M	6.3/.60		17.6

MAXIMUM RATINGS		TYPICAL OPERATION				REMARKS	Type
Focusing Electrode (Kv)	Accel. Grid (G2) Volts	Anode (Kv)	Focus Electrode Volts	Accel. Grid (G2) Volts	Negative Grid No. 1 or Positive Cathode Voltage for Raster Cutoff		
			Magnet Coil Current in Ma.				
-40 to +1.25	70	16	-100 to +300	50	32-50	19EAP4 19EBP4 19ECP4	
-50 to +1.0	550	16	0 to 400	400	39-94		
-50 to +1.0	250	16	-250 to +150	150	36-54		
-55 to +1.1	550	20	0 to 400	400	46-94	19EDP4	
-50 to +1.1	60	16	250	50	35-55	19EFP4 19EGP4	
-50 to +1.0	60	16	250	50	35-55		
-55 to +1.1	550	16	0 to 400	300	35-72	19EHP4 19EHP4A	
-55 to +1.1	550	16	0 to 400	300	35-72		
-55 to +1.1	60	16	0 to 400	30	30-45	19EJP4	
-50 to +1.1	55	16	0 to 500	45	35-50	19EKP4 19ELP4	
-55 to +1.1	550	14	0 to 400	400	36-94		
-50 to +1.0	60	16	0 to 400	50	32-50	Welded Tension Band 19ENP4 19ENP4A 19ESP4	
-50 to +1.0	60	16	0 to 400	50	32-50		
-55 to +1.1	70	16	0 to 400	50	32-50		
-50 to +1.0	60	16	0 to 400	50	32-50	19ETP4 19EUP4	
-50 to +1.0	550	16	0 to 400	400	39-94		
-50 to +1.1	55	16	0 to 500	45	35-50	19EZP4 19FP4	
Magnetic	450	13	120 Ma.	250	27-63		
-50 to +1.0	60	12	0 to 400	50	35-55	19FBP4	
-55 to +1.1	550	20	-200 to +200	400	50-98	19FCP4 19FEP4 19FEP4A	
-55 to +1.1	60	16	0 to 400	30	30-45		
-55 to +1.1	60	16	0 to 400	30	30-45		
-55 to +1.1	60	16	0 to +400	30	22-45	19FEP4B 19FGP4	
-35 to +7.0	600	16	0 to 400	500	43-78		
-50 to +1.0	550	16	0 to 400	400	39-94	19FHP4 19FJP4	
-55 to +1.1	550	16	0 to 400	300	35-72		
-55 to +1.1	550	16	0 to 400	400	+40 to +76*	19FJP4A 19FKP4	
-55 to +1.1	550	16	0 to +400	300	35-72		
-55 to +1.1	550	16	-100 to +300	300	28-62	19FLP4 19FNP4	
-55 to +1.1	550	16	0 to 400	300	28-62		
-50 to +1.0	550	16	0 to 400	400	39-94	19FRP4 19FTP4	
-55 to +1.1	600	16	0 to 400	500	50-93		
-55 to +1.1	550	16	0 to 400	400	42-78	19FZP4	
-50 to +1.1	550	16	0 to 500	400	+35 to +72*	19GAP4 19GBP4	
-55 to +1.1	550	20	0 to 500	400	+45 to +70*		
-55 to +1.1	550	18	0 to 400	400	+36 to +78*	Welded Tension Band 19GEP4 19GEP4A	
-55 to +1.1	550	18	0 to 400	400	+36 to +78*		
-40 to +1.25	80	16	-200 to +200	50	+33 to +45*	19GHP4	
-55 to +1.1	550	20	-200 to +200	400	50-98	Welded Tension Band 19GJP4 19GJP4A	
-55 to +1.1	550	20	-200 to +200	400	50-98		
-55 to +1.1	550	16	0 to 400	300	28-62	19GKP4 19GMP4	
-40 to +1.25	70	16	0 to 400	50	32-50		
-50 to +1.0	60	16	250	50	35-55	19HAP4	
-50 to +1.1	250	16	0 to 400	150	+38 to +62*	19HGP4 19XP4	
-55 to +1.1	550	16	0 to 400	400	41-99		
-35 to +7.0	600	16	0 to 400	500	48-83	Tri-Potential Electrostatic Focus 19YP4 19ZP4	
-50 to +1.0	700	16.5	0 to 500	450	33-77		
-40 to +1.25	70	16	-200 to +200	50	+32 to +52*	20ABP4	
-40 to +1.25	60	16	-200 to +200	35	+30 to +42*	20ADP4 20AEP4	
-55 to +1.1	60	16	0 to 400	30	+30 to +45*		
Magnetic	450	16	110 Ma.	300	33-77	20CP4 20CP4A	
Magnetic	450	16	110 Ma.	300	33-77		
Magnetic	450	16	110 Ma.	300	33-77	20CP4B	
Magnetic	450	16	110 Ma.	300	33-77	20CP4C 20CP4D	
Magnetic	450	16	110 Ma.	300	33-77		
Magnetic	450	16	110 Ma.	300	33-77	20DP4 20DP4A	
Magnetic	450	16	110 Ma.	300	33-77		
Magnetic	450	16	110 Ma.	300	33-77	20DP4B 20DP4C	
Magnetic	450	16	110 Ma.	300	33-77		
Magnetic	450	16	110 Ma.	300	33-77	20DP4D 20FP4	
Magnetic	450	16	110 Ma.	300	33-77		
+5.5m	450	12	2300 to 3200	300	33-77	20GP4 20HP4	
+5.5m	450	16	3150 to 4270	300	33-77		
-55 to +1.1	550	14	-56 to +310	300	33-77	20HP4	

# Monochrome TV Picture Tubes Data (cont'd)

Type	Defl. Angle and Neck Dia. ↓	FACEPLATE		OVERALL DIMENSIONS INCHES		External Conductive Coating Capacitance (pf)	** Ion Trap	Base	Basing	Heater▲ Volts/Amps	DESH	
		Clear Tinted Alum. Shield* Anti-Refll.		Faceplate Dimensions	Length						Anode (Kv)	
20HP4A	70	T		18 $\frac{1}{2}$ x 14 $\frac{1}{2}$	21 $\frac{3}{4}$	500-1500	S	B6-63/B6-203	12L	6.3/60	17.6	
20HP4B	70	T, AR		18 $\frac{1}{2}$ x 14 $\frac{1}{2}$	21 $\frac{3}{4}$	.....	S	B6-63/B6-203	12M	6.3/60	17.6	
20HP4C	70	TA		18 $\frac{1}{2}$ x 14 $\frac{1}{2}$	21 $\frac{3}{4}$	.....	S	B6-63/B6-203	12M	6.3/60	17.6	
20HP4D	70	TA		18 $\frac{1}{2}$ x 14 $\frac{1}{2}$	21 $\frac{3}{4}$	500-1500	S	B6-63/B6-203	12L	6.3/60	17.6	
20HP4E	70	TA		18 $\frac{1}{2}$ x 14 $\frac{1}{2}$	21 $\frac{3}{4}$	500-1500	N	B6-63/B6-203	12L	6.3/60	17.6	
20JP4	70	T		18 $\frac{1}{2}$ x 14 $\frac{1}{2}$	21 $\frac{3}{4}$	500-750	S	B5-57	12P	6.3/60	19.8	
20LP4	70	T		18 $\frac{1}{2}$ x 14 $\frac{1}{2}$	21 $\frac{3}{4}$	750-1500	S	B6-63	12L	6.3/60	17.6	
20MP4	70	T		18 $\frac{1}{2}$ x 14 $\frac{1}{2}$	21 $\frac{3}{4}$	500-1500	S	B6-63	12L	6.3/60	17.6	
20RP4	114	TA, BR		17 $\frac{3}{4}$ x 13 $\frac{3}{4}$	12 $\frac{1}{4}$	1600-2200	N	B7-208	8HR	6.3/45	22	
20SP4	114	TA, TB		16 $\frac{3}{4}$ x 13 $\frac{3}{4}$	12 $\frac{1}{4}$	1400-2000	N	B7-208	8HR	6.3/45	23	
20TP4	114	TA, TB		16 $\frac{3}{4}$ x 13 $\frac{3}{4}$	12 $\frac{1}{4}$	1400-2000	N	B7-208	8HR	6.3/45	23	
20UP4	114	TA, BF		17 $\frac{1}{4}$ x 13 $\frac{3}{4}$	12 $\frac{3}{4}$	1200-1700	N	B7-208	8HR	6.3/45	23	
20WP4	114	TA, BR		16 $\frac{3}{4}$ x 13 $\frac{3}{4}$	12 $\frac{1}{4}$	1600-2000	N	B7-208	8HR	6.3/45	23	
20XP4	114	TA, BR		16 $\frac{3}{4}$ x 13 $\frac{3}{4}$	12 $\frac{1}{4}$	1500-2000	N	B7-208	8HR	6.3/45	23	
20YP4	114	TA, BR		16 $\frac{3}{4}$ x 13 $\frac{3}{4}$	12 $\frac{1}{4}$	1500-2000	N	B7-208	8HR	6.3/45	23	
20ZP4	114	TA, BR		16 $\frac{3}{4}$ x 13 $\frac{3}{4}$	12 $\frac{1}{4}$	1500-2000	N	B7-208	8HR	6.3/45	23	
21AP4	70	T, AR		19 $\frac{3}{4}$ x 15 $\frac{3}{4}$	22 $\frac{3}{4}$	.....	S	B5-57	12D	6.3/60	19.8	
21ACP4	90	T		20 $\frac{1}{4}$ x 16 $\frac{3}{4}$	20	2000-2500	S	B5-57	12N	6.3/60	22	
21ACP4A	90	TA		20 $\frac{1}{4}$ x 16 $\frac{3}{4}$	20	2000-2500	S	B5-57	12N	6.3/60	22	
21AFP4	70	T		20 $\frac{1}{4}$ x 15 $\frac{3}{4}$	23	.....	S	B6-63	12M	6.3/60	19.8	
21ALP4	90	TA		20 $\frac{1}{4}$ x 16 $\frac{3}{4}$	20	500-750	S	B6-63	12L	6.3/60	19.8	
21ALP4A	90	TA		20 $\frac{1}{4}$ x 16 $\frac{3}{4}$	20	500-750	S	B6-63	12L	6.3/60	19.8	
21ALP4B	90	TA		20 $\frac{1}{4}$ x 16 $\frac{3}{4}$	20	500-750	S	B6-63	12L	6.3/60	22	
21AMP4	90	T		20 $\frac{1}{4}$ x 16 $\frac{3}{4}$	20	500-750	S	B5-57	12N	6.3/60	19.8	
21AMP4A	90	TA		20 $\frac{1}{4}$ x 16 $\frac{3}{4}$	20	500-750	S	B5-57	12N	6.3/60	19.8	
21AMP4B	90	TA		20 $\frac{1}{4}$ x 16 $\frac{3}{4}$	20	500-750	N	B5-57	12N	6.3/60	19.8	
21ANP4	90	T		20 $\frac{1}{4}$ x 16 $\frac{3}{4}$	20	.....	S	B6-63	12M	6.3/60	19.8	
21ANP4A	90	TA		20 $\frac{1}{4}$ x 16 $\frac{3}{4}$	20	.....	S	B6-63	12M	6.3/60	19.8	
21AQP4	90	T		20 $\frac{1}{4}$ x 16 $\frac{3}{4}$	20	.....	S	B5-57	12D	6.3/60	19.8	
21AQP4A	90	TA		20 $\frac{1}{4}$ x 16 $\frac{3}{4}$	20	.....	S	B5-57	12D	6.3/60	19.8	
21ARP4	70	T		20 $\frac{1}{4}$ x 15 $\frac{3}{4}$	23 $\frac{1}{2}$	500-750	I	B5-57	12N	6.3/60	22	
21ARP4A	70	TA		20 $\frac{1}{4}$ x 15 $\frac{3}{4}$	23 $\frac{1}{2}$	500-750	I	B5-57	12N	6.3/60	22	
21ASP4	70	T		18 $\frac{1}{2}$ x 14 $\frac{1}{2}$	22 $\frac{3}{4}$	.....	S	B6-63	12M	6.3/60	19.8	
21ATP4	90	TA		20 $\frac{1}{4}$ x 16 $\frac{3}{4}$	20	1200-1500	S	B6-63	12L	6.3/60	19.8	
21ATP4A	90	TA		20 $\frac{1}{4}$ x 16 $\frac{3}{4}$	20	1200-1500	S	B6-63	12L	6.3/60	22	
21ATP4B	90	T		20 $\frac{1}{4}$ x 16 $\frac{3}{4}$	20	1200-1500	S	B6-63	12L	6.3/60	19.8	
21AUP4	72	T		20 $\frac{1}{4}$ x 16 $\frac{3}{4}$	23 $\frac{1}{2}$	2000-2500	S	B6-63	12L	6.3/60	19.8	
21AUP4A	72	TA		20 $\frac{1}{4}$ x 16 $\frac{3}{4}$	23 $\frac{1}{2}$	2000-2500	S	B6-63	12L	6.3/60	19.8	
21AUP4B	72	TA		20 $\frac{1}{4}$ x 16 $\frac{3}{4}$	23 $\frac{1}{2}$	2000-2500	S	B6-63	12L	6.3/60	22	
21AUP4C	72	TA		20 $\frac{1}{4}$ x 16 $\frac{3}{4}$	23 $\frac{1}{2}$	2000-2500	N	B6-63	12L	6.3/60	22	
21AVP4	72	T		20 $\frac{1}{4}$ x 16 $\frac{3}{4}$	23 $\frac{1}{2}$	2000-2500	S	B6-63/B6-203	12L	6.3/60	19.8	
21AVP4A	72	TA		20 $\frac{1}{4}$ x 16 $\frac{3}{4}$	23 $\frac{1}{2}$	2000-2500	S	B6-63/B6-203	12L	6.3/60	19.8	
21AVP4B	72	TA		20 $\frac{1}{4}$ x 16 $\frac{3}{4}$	23 $\frac{1}{2}$	2000-2500	S	B6-63/B6-203	12L	6.3/60	22	
21AVP4C	72	TA		20 $\frac{1}{4}$ x 16 $\frac{3}{4}$	23 $\frac{1}{2}$	2000-2500	N	B6-63/B6-203	12L	6.3/60	22	
21AWP4	72	TA		20 $\frac{1}{4}$ x 16 $\frac{3}{4}$	23 $\frac{1}{2}$	2000-2500	S	B5-57	12N	6.3/60	19.8	
21AWP4A	72	TA		20 $\frac{1}{4}$ x 16 $\frac{3}{4}$	23 $\frac{1}{2}$	2000-2500	N	B5-57	12N	6.3/60	19.8	
21AYP4	70	T		18 $\frac{1}{2}$ x 14 $\frac{1}{2}$	22 $\frac{3}{4}$	750-2500	S	B6-63	12L	6.3/60	22	
21BAP4	90	TA		20 $\frac{1}{4}$ x 16 $\frac{3}{4}$	20	2000-2500	N	B6-63	12L	6.3/60	22	
21BCP4	70	TA		20 $\frac{1}{4}$ x 16 $\frac{3}{4}$	23 $\frac{1}{2}$	500-750	N	B6-63	12L	6.3/60	22	
21BDP4	72	TA		20 $\frac{1}{4}$ x 16 $\frac{3}{4}$	23 $\frac{1}{2}$	500-750	N	B6-63	12L	6.3/60	22	
21BNP4	90	TA		20 $\frac{1}{4}$ x 16 $\frac{3}{4}$	20	2000-2500	N	B6-63	12L	6.3/60	22	
21BSP4	90	TA		20 $\frac{1}{4}$ x 16 $\frac{3}{4}$	20	2000-2500	S	B5-57	12N	6.3/60	22	
21BTP4	90	TA		20 $\frac{1}{4}$ x 16 $\frac{3}{4}$	20	2000-2500	S	B6-63	12L	6.3/60	22	
21CBP4	90	TA		20 $\frac{1}{4}$ x 16 $\frac{3}{4}$	18	2000-2500	N	B6-63	12L	6.3/60	19.8	
21CBP4A	90	TA		20 $\frac{1}{4}$ x 16 $\frac{3}{4}$	18	2000-2500	N	B6-63	12L	6.3/60	22	
21CBP4B	90	TA		20 $\frac{1}{4}$ x 16 $\frac{3}{4}$	18	2000-2500	N	B6-63	12L	6.2/60	20	
21CDP4	90	T		20 $\frac{1}{4}$ x 16 $\frac{3}{4}$	20	2000-2500	S	B6-63	12L	6.3/45	22	
21CDP4A	90	TA		20 $\frac{1}{4}$ x 16 $\frac{3}{4}$	20	2000-2500	S	B6-63	12L	6.3/45	22	
21CEP4	110	TA		20 $\frac{1}{4}$ x 16 $\frac{3}{4}$	14 $\frac{3}{4}$	2000-2500	N	B7-208	8HR	6.3/60	19.8	
21CEP4A	110	TA		20 $\frac{1}{4}$ x 16 $\frac{3}{4}$	14 $\frac{3}{4}$	2000-2500	N	B7-208	8HR	6.3/60	22	
21CGP4	90	TA		20 $\frac{1}{4}$ x 16 $\frac{3}{4}$	20	2000-2500	S	B6-63	12L	6.3/60	22	
21CHP4	90	TA		20 $\frac{1}{4}$ x 16 $\frac{3}{4}$	18	2000-2500	N	B6-63	12L	6.3/60	22	
21CKP4	90	TA		20 $\frac{1}{4}$ x 16 $\frac{3}{4}$	18	2000-2500	N	B6-63	12L	6.3/45	22	
21CLP4	90	TA		20 $\frac{1}{4}$ x 16 $\frac{3}{4}$	19	1250-1750	S	B7-51	12AJ	6.3/30	19.8	
21CMP4	90	TA		20 $\frac{1}{4}$ x 16 $\frac{3}{4}$	19	2000-2500	S	B6-63	12L	6.3/60	22	

MAXIMUM RATINGS		TYPICAL OPERATION				REMARKS	Type
Focusing Electrode (Kv)	Accel. Grid (G2) Volts	Anode (Kv)	Focus Electrode Volts Magnet Coil Current in Ma.	Accel. Grid (G2) Volts	Negative Grid No. 1 or Positive Cathode Voltage for Raster Cutoff		
-55 to +1.1	550	14	-56 to +310	300	33-77		20HP4A
-55 to +1.1	550	14	-56 to +310	300	33-77		20HP4B
-55 to +1.1	550	14	-56 to +310	300	33-77		20HP4C
-55 to +1.1	550	14	-56 to +310	300	33-77		20HP4D
-55 to +1.1	550	14	-56 to +310	300	33-77		20HP4E
Auto. Es.	550	12	Auto. Es.	300	33-77		20JP4
-1.1 to +2.2	550	14	0	300	33-77		20LP4
-55 to +1.1	550	14	-55 to +300	300	33-77		20MP4
-40 to +1.25	60	16	0 to 400	50	+33 to +50*		20RP4
-40 to +1.25	60	16	-100 to +300	30	+22 to +40*		20SP4
-55 to +1.1	550	16	0 to +400	300	+28 to +62*		20TP4
-55 to +1.1	550	16	0 to +500	400	+35 to +72*		20UP4
-55 to +1.1	550	18	0 to 400	400	+36 to +78*		20WP4
-55 to +1.1	550	20	-200 to +200	400	50-98		20XP4
-40 to +1.25	70	16	-200 to +200	50	+32 to +52*		20YP4
-40 to +1.25	70	16	-200 to +200	50	+32 to +52*		20ZP4
Magnetic	550	16	110 Ma.	300	33-77	Metal Bulb	21AP4
Magnetic	550	16	117 Ma.	300	33-77		21ACP4
Magnetic	550	16	117 Ma.	300	33-77		21ACP4A
-55 to +1.1	550	16	-64 to +350	300	33-77		21AFP4
-55 to +1.1	550	16	-64 to +350	300	33-77		21ALP4
-55 to +1.1	550	16	-64 to +350	300	33-77		21ALP4A
Magnetic	550	16	102 Ma.	300	33-77		21ALP4B
Magnetic	550	16	102 Ma.	300	33-77		21AMP4
Magnetic	550	16	102 Ma.	300	33-77		21AMP4A
Magnetic	550	16	102 Ma.	300	33-77		21AMP4B
-55 to +1.1	550	16	-64 to +350	300	33-77		21ANP4
-55 to +1.1	550	16	-64 to +350	300	33-77		21ANP4A
Magnetic	550	16	102 Ma.	300	33-77		21AQP4
Magnetic	550	16	102 Ma.	300	33-77		21AQP4A
Int. Mag.	550	16	Int. Mag.	300	33-77	Internal Magnet for Focus	21ARP4
Int. Mag.	550	16	Int. Mag.	300	33-77		21ARP4A
-55 to +1.1	550	16	-64 to +352	300	33-77		21ASP4
-55 to +1.1	550	16	-64 to +350	300	33-77		21ATP4
-55 to +1.1	550	16	-64 to +350	300	33-77		21ATP4A
-55 to +1.1	550	16	-64 to +350	300	33-77		21ATP4B
-55 to +1.1	550	16	-64 to +352	300	33-77		21AUP4
-55 to +1.1	550	16	-64 to +352	300	33-77		21AUP4A
-55 to +1.1	550	16	-64 to +352	300	33-77		21AUP4B
-55 to +1.1	550	16	-64 to +352	300	33-77		21AUP4C
-55 to +1.1	550	16	-64 to +352	300	33-77		21AVP4
-55 to +1.1	550	16	-64 to +352	300	33-77		21AVP4A
-55 to +1.1	550	16	-64 to +352	300	33-77		21AVP4B
-55 to +1.1	550	16	-64 to +352	300	33-77		21AVP4C
Magnetic	550	16	108 Ma.	300	33-77		21AWP4
Magnetic	550	16	108 Ma.	300	33-77		21AWP4A
-55 to +1.1	550	16	-64 to +352	300	33-77		21AYP4
-55 to +1.1	550	16	0 to 500	300	33-77		21BAP4
-55 to +1.1	550	16	+50 to +550	300	33-77		21BCP4
-55 to +1.1	550	16	+50 to +550	300	33-77		21BDP4
-55 to +1.1	550	16	0 to 500	300	33-77		21BNP4
Magnetic	550	16	116 Ma.	300	33-77		21BSP4
-55 to +1.1	550	16	-64 to +350	300	33-77		21BTP4
-55 to +1.1	550	18	-70 to +396	300	33-77		21CBP4
-5 to +1.0	550	16	0 to 450	300	33-77		21CBP4A
-50 to +1.0	550	16	-50 to +350	300	28-72		21CBP4B
-55 to +1.1	550	16	-64 to +352	300	33-77		21CDP4
-55 to +1.1	550	16	-64 to +352	300	33-77		21CDP4A
-55 to +1.1	550	16	0 to 400	400	41-99		21CEP4
-55 to +1.1	550	16	0 to 400	400	41-99		21CEP4A
-55 to +1.1	220	13	-72 to +396	110	+37 to +55*		21CGP4
-55 to +1.1	220	18	-50 to +350	110	+37 to +55*		21CHP4
-55 to +1.1	550	16	-50 to +350	300	33-77		21CKP4
-55 to +.55	550	16	-75 to +235	300	40-80		21CLP4
-55 to +1.1	550	16	-64 to +352	300	33-77		21CMP4

# Monochrome TV Picture Tubes Data (cont'd)

Type	Defl. Angle and Neck Dia. ↓	FACEPLATE		OVERALL DIMENSIONS INCHES		External Conductive Coating Capacitance (pf)	** Ion Trap	Base	Basing	Heater Volts/Amps	DESIGN	
		Clear Tinted Alum. Shield* Anti-Refll.	Faceplate Dimensions	Length	Anode (Kv)							
21CQP4	110	TA	20¼ x 16⅝	14¼	2000-2500	N	B6-185	7FA	6.3/60	19.8		
21CSP4	110	TA	20¼ x 16⅝	14¼	2000-2500	N	B6-185	7FA	6.3/45	19.8		
21CUP4	90	TA	20¼ x 16⅝	20	2000-2500	N	B5-57	12N	6.3/60	22		
21CVP4	90	TA	20¼ x 16⅝	20	2000-2500	N	B6-63	12L	6.3/60	22		
21CWP4	90	TA	22¼ x 16⅝	20	2000-2500	N	B6-63	12L	6.3/60	22		
21CXPA	90	TA	20¼ x 16⅝	18	2000-2500	N	B6-63	12L	6.3/60	22		
21CZPA	110	TA	20¼ x 16⅝	14¼	2000-2500	S	B7-183	8HR	6.3/60	19.8		
21DPA	70	T, AR	19½ x 15¼	22½ <sup>cm</sup>	.....	S	B6-63	12M	6.3/60	19.8		
21DAPA	110	TA	20¼ x 16⅝	14¼	2000-2500	N	B7-208	8HR	6.3/60	19.8		
21DEPA	110	TA	20¼ x 16⅝	14¼	2000-2500	N	B7-183/B7-208	8HR	6.3/60	19.8		
21DEPA4	110	TA	20¼ x 16⅝	14¼	2000-2500	N	B7-183/B7-208	8HR	6.3/60	22		
21DFPA	110	TA	20¼ x 16⅝	14¼	1500-2200	N	B7-183/B7-208	8HR	6.3/60	19.8		
21DHP4	110	TA	20¼ x 16⅝	14¼	1700-2500	N	B7-183/B7-208	8HR	6.3/45	19.8		
21DJPA	90	TA	20¼ x 16⅝	18	2000-2500	N	B6-63	12L	6.3/30	22		
21DKPA	110	TA	20¼ x 16⅝	14¼	1700-2500	N	B7-183/B7-208	8HR	6.3/30	19.8		
21DKPA4	110	TA	20¼ x 16⅝	14¼	1700-2500	N	B7-183/B7-208	8HR	6.3/30	19.8		
21DLP4	90	TA	20¼ x 16⅝	17	2000-2500	N	B6-63	12L	6.3/60	22		
21DMP4	110	TA	20¼ x 16⅝	13¾	2000-2500	N	B7-183/B7-208	8HR	6.3/60	22		
21DNP4	90	TA	20¼ x 16⅝	19	1200-1500	S	B6-63	12L	6.3/60	22		
21DQP4	90	TA	20¼ x 16⅝	17½	2000-2500	N	B6-63	12L	6.3/60	20		
21DRPA	90	TA	20¼ x 16⅝	18¼	2000-2500	N	B6-63/B6-203	12L	6.3/60	22		
21DSP4	90	TA	20¼ x 16⅝	18	2000-2500	N	B6-63	12L	6.3/60	22		
21DVP4	90	TA	20¼ x 16⅝	20	500-750	S	B6-63	12L	6.3/30	22		
21DWP4	110	TA	20¼ x 16⅝	14¼	2000-2500	N	B7-183/B7-208	8HR	6.3/60	19.8		
21EP4	70	T	20¼ x 15¾	23	.....	S	B5-57	12D	6.3/60	19.8		
21EPA4	70	T	20¼ x 15¾	23	500-750	S	B5-57	12N	6.3/60	19.8		
21EP4B	70	TA	20¼ x 15¾	23	500-750	S	B5-57	12N	6.3/60	19.8		
21EP4C	70	TA	20¼ x 15¾	23	500-750	S	B5-57	12N	6.3/60	19.8		
21EAP4	110	TA	20¼ x 16⅝	12¾	1500-2000	N	B7-208	8JK	2.35/60	20		
21ELP4	90	TA	20¼ x 16⅝	19	2000-2500	N	B6-63	12L	6.3/30	22		
21EMP4	110	TA	20¼ x 16⅝	13¾	2000-2500	N	B7-183	8HR	6.3/60	19.8		
21ENP4	90	TA	20¼ x 16⅝	19	2000-2500	S	B6-63	12L	6.3/30	22		
21EQP4	110	TA	20¼ x 16⅝	12¾	2000-2500	N	B7-208	8JR	6.3/60	20		
21ERP4	110	TA, AR, BP	20¼ x 16⅝	12¾	1500-2000	N	B7-208	8JR	6.3/60	20		
21ESP4	110	TA	20¼ x 16⅝	13¾	2000-2500	N	B6-226/B7-208	8JS	6.3/60	19.8		
21EVP4	110	TA	20¼ x 16⅝	12¾	1500-2000	N	B7-208	8JK	2.68/45	20		
21EWP4	72	TA	20¼ x 16⅝	23½	.....	N	B5-57	12D	6.3/60	22		
21EXP4	110	TA	20¼ x 16⅝	12¾	2000-2500	N	B7-208	8JR	6.3/30	20		
21EYP4	72	TA	20¼ x 16⅝	23½	1200-1500	N	B6-63/B6-203	12L	6.3/60	22		
21EZP4	110	TA	20¼ x 16⅝	12¾	2000-2500	N	B7-208	8JR	6.3/30	19.8		
21FP4	70	T	20¼ x 15¾	23½	.....	S	B6-63/B6-203	12M	6.3/60	19.8		
21FP4A	70	T	20¼ x 15¾	23½	500-750	S	B6-63/B6-203	12L	6.3/60	19.8		
21FP4C	70	TA	20¼ x 15¾	23½	500-750	S	B6-63/B6-203	12L	6.3/60	19.8		
21FP4D	70	TA	20¼ x 15¾	23½	500-750	N	B6-63/B6-203	12L	6.3/60	19.8		
21FAP4	110	TA	19¾ x 16⅝	12¾	2000-2500	N	B7-208	8JR	6.3/60	22		
21FCP4	110	TA	20¼ x 16⅝	13½	2000-2500	N	B7-208	8HR	6.3/30	18		
21FDP4	110	TA	20¼ x 16⅝	13½	1500-2000	N	B7-208	8KW	6.3/60	20		
21FLP4	90	TA	20¼ x 16⅝	18	500-2500	N	B6-63	12L	6.3/60	22		
21FMP4	110	TA	20¼ x 16⅝	14¾	2000-2500	N	B7-237/B7-208	8HR	6.3/60	22		
21FUP4	114	TA-BF	18¾ x 15¼	12¾	1700-2500	N	B7-208	8HR	6.3/45	23		
21FVP4	114	TA-BR	18¾ x 14¾	12¾	1500-2300	N	B7-208	8HR	6.3/45	23		
21FWP4	114	TA-BR	18¾ x 14¾	12¾	1500-2300	N	B7-208	8HR	6.3/45	23		
21FXP4	114	TA-BF	18¾ x 15¼	12¾	1500-2000	N	B7-208	8HR	6.3/45	23		
21FYP4	114	TA-BR	18¾ x 15¼	12¾	1900-2400	N	B7-208	8HR	6.3/45	22		
21FZP4	114	TA-BR	18¾ x 14¾	12¾	1700-2500	N	B7-208	8HR	6.3/45	23		
21GAP4	114	TA-BR	18¾ x 14¾	12¾	1300-2000	N	B7-208	8HR	6.3/45	23.5		
21GAP4A	114	TA-BR	18¾ x 14¾	12¾	1300-2000	N	B7-208	8HR	6.3/45	23.5		
21GBP4	114	TA-BR	18¾ x 14¾	12¾	1500-2300	N	B7-208	8HR	6.3/45	23		
21GCP4	114	TA-BR	18¾ x 14¾	12¾	1700-2500	N	B7-208	8HR	6.3/45	23		
21GHP4	114	TA	18¾ x 14¾	12¾	1500-2300	N	B7-208	8HR	6.3/45	23.5		
21GJP4	114	TA-BR	18¾ x 14¾	12¾	1500-2300	N	B7-183	8HR	6.3/60	20		
21GKP4	114	TA-BR	18¾ x 14¾	12¾	1700-2500	N	B7-208	8HR	6.3/45	23		
21GTP4	114	TA-BF	18¾ x 15¼	12¾	1700-2500	N	B7-208	8HR	6.3/315	23		
21JP4	70	T	20¼ x 15¾	23½	500-750	I	B5-57	12N	6.3/60	22		
21JPA4	70	TA	20¼ x 15¾	23½	500-750	I	B5-57	12N	6.3/60	22		

MAXIMUM RATINGS		TYPICAL OPERATION				REMARKS	Type
Focusing Electrode (Kv)	Accel. Grid (G2) Volts	Anode (Kv)	Focus Electrode Volts	Accel. Grid (G2) Volts	Negative Grid No. 1 or Positive Cathode Voltage for Raster Cutoff		
			Magnet Coil Current in Ma.				
-55 to +1.1	550	16	-50 to +350	300	40-77	Light Weight Bulb	21CQP4
-55 to +1.1	550	16	0 to 400	300	40-77	Light Weight Bulb	21CSP4
Magnetic	550	16	117 Ma.	300	33-77		21CUP4
-55 to +1.1	550	16	-64 to +352	300	33-77		21CVP4
-55 to +1.1	550	16	-64 to +352	300	33-77		21CWP4
-55 to +1.1	70	18	0 to 350	50	+39 to +57*		21CXP4
-55 to +1.1	550	17	0 to 500	300	33-77	Light Weight Bulb	21CZP4
+5.5m	550	16	3150 to 4270	300	33-77	Metal Bulb	21DP4
-55 to +1.1	550	16	0 to 400	400	41-99	Light Weight Bulb	21DAP4
-55 to +1.1	550	17	0 to 500	300	33-77	Light Weight Bulb	21DEP4
-55 to +1.1	550	17	0 to 500	300	33-77	Light Weight Bulb	21DEP4A
-55 to +1.1	550	16	0 to 400	400	41-99		21DFP4
-55 to +1.1	550	16	0 to 400	300	40-77	Light Weight Bulb	21DHP4
-55 to +1.1	550	16	-50 to +350	300	40-77		21DJP4
-55 to +1.1	550	16	0 to 400	300	40-77	Light Weight Bulb	21DKP4
-55 to +1.1	550	16	0 to 400	300	40-77	Light Weight Bulb; 18 Sec. Heater Warm-up	21DKP4A
-55 to +1.1	550	16	0 to 400	300	33-77		21DLP4
-55 to +1.1	550	16	-50 to +350	400	41-97	Light Weight Bulb	21DMP4
-55 to +1.1	550	16	-64 to +352	300	40-77		21DNP4
-55 to +1.1	550	16	-50 to +350	300	40-77		21DQP4
-55 to +1.1	550	16	0 to 450	300	33-77	Light Weight Bulb	21DRP4
-55 to +1.1	70	16	0 to 400	50	+37 to +55*		21DSP4
-55 to +1.1	550	18	0 to 400	300	33-77		21DVP4
-55 to +1.1	550	14	-50 to +350	450	50-110		21DWP4
Magnetic	550	16	95 Ma.	300	33-77	Cylindrical Faceplate	21EP4
Magnetic	550	16	95 Ma.	300	33-77	Cylindrical Faceplate	21EP4A
Magnetic	550	16	95 Ma.	300	33-77	Cylindrical Faceplate	21EP4B
-70 to +.95	550	16	100 to 500	300	40-77	Cylindrical Faceplate	21EPC
-55 to +1.1	550	16	0 to 400	450	50-110	Light Weight Bulb; 2.35 Volt Heater	21EPA4
-55 to +1.1	550	16	0 to 400	450	50-110		21ELP4
-55 to +1.1	550	16	0 to 400	450	50-110		21EMP4
-55 to +1.1	550	16	-64 to +352	300	40-77		21ENP4
+ .70m	600	16	0 to 400	500	48-77	Tri-Potential Electrostatic Focus	21EQP4
+ .70m	600	16	0 to 400	500	48-77	Tri-Potential Focus; Formed Cover Plate	21ERP4
-55 to +1.1	825	17	0 to 500	450	33-77	Light Weight Bulb	21ESP4
- .7 to +.95	550	16	100 to 500	300	40-77	Light Weight Bulb; 2.68 Volt Heater	21EVP4
Magnetic	1100	18	115 Ma.	300	33-75	Monitor Tube	21EWP4
+ .70m	600	16	0 to 400	500	48-83	Tri-Potential Electrostatic Focus	21EX4
800	700	18	0 to 400	300	33-77	Monitor Tube	21EY4
+ .715m	600	18	0 to 400	500	+46 to +74*	Tri-Potential Focus	21EZP4
-55 to +1.1	550	16	-64 to +350	300	33-77	Cylindrical Faceplate	21FP4
-55 to +1.1	550	16	-64 to +350	300	33-77	Cylindrical Faceplate	21FP4A
-55 to +1.1	550	16	-64 to +350	300	33-77	Cylindrical Faceplate	21FP4C
-55 to +1.1	550	16	-64 to +350	300	33-77	Cylindrical Faceplate	21FP4D
+ .70m	600	16	0 to 400	500	48-83	Light Weight Bulb; Tri-Potential Focus	21FAP4
-55 to +1.1	550	16	0 to 400	300	+39 to +68*		21FCP4
-55 to +1.1	550	16	+100 to +500	300	40-77		21FDP4
-50 to +1.0	550	16	0 to 450	300	33-77		21FLP4
-50 to +1.0	100	18	0 to 500	50	31-49		21FMP4
-50 to +1.0	60	16	0 to 400	50	35-55		21FUP4
-55 to +1.1	550	20	-100 to +300	400	36-78		21FVP4
-55 to +1.1	550	20	-100 to +300	400	36-78		21FWP4
-55 to +1.1	550	16	0 to 500	400	35-72		21FXP4
-40 to +1.2	60	16	0 to +400	50	+33 to +45*		21FYP4
-50 to +1.0	550	16	0 to 400	400	39-93		21FZP4
-55 to +1.1	60	16	0 to 400	30	+30 to +45*		21GAP4
-55 to +1.1	60	16	0 to 400	30	+30 to +45*		21GAP4A
-50 to +1.0	70	16	0	50	36-54		21GBP4
-55 to +1.1	550	16	0 to 400	400	+39 to +93*		21GCP4
-55 to +1.1	60	16	0 to 400	30	+30 to +45*		21GHP4
-55 to +1.1	550	16	0 to 400	400	36-94		21GJP4
-55 to +1.1	60	16	0 to 400	50	+35 to +55*		21GKP4
-50 to +1.0	60	16	0 to 400	50	35-55		21GTP4
Int. Mag.	550	16	Int. Mag.	300	33-77	Cylindrical Faceplate	21JP4
Int. Mag.	550	16	Int. Mag.	300	33-77	Cylindrical Faceplate	21JPA4

# Monochrome TV Picture Tubes Data (cont'd)

Type	Defl. Angle and Neck Dia. ♦	FACEPLATE	OVERALL DIMENSIONS INCHES		External Conductive Coating Capacitance (pf)	** Ion Trap	Base	Basing	Heater▲ Volts/Amps	DESIGN	
			Clear Tinted Alum. Shield* Anti-Ref.	Faceplate Dimensions						Length	Anode (Kv)
21KP4	70	T		20½ x 15¾	22⅞	.....	S	B5-57	12D	6.3/60	19.8
21KP4A	70	T		20½ x 15¾	22⅞	500-750	S	B5-57	12P	6.3/60	19.8
21MP4	70	T, AR		19¾ x 15¾	22⅞	.....	S	B6-63	12M	6.3/60	17.6
21WP4	70	T		18¼ x 14¾	22⅞	500-750	S	B5-57	12N	6.3/60	19.8
21WP4A	70	TA		18¼ x 14¾	22⅞	500-750	S	B5-57	12N	6.3/60	19.8
21WP4B	70	TA		18¼ x 14¾	22⅞	500-750	N	B5-57	12N	6.3/60	19.8
21XP4	70	T		18¼ x 14¾	22⅞	2000-2500	S	B6-63/B6-203	12L	6.3/60	19.8
21XP4A	70	TA		18¼ x 14¾	22⅞	2000-2500	S	B6-63/B6-203	12L	6.3/60	19.8
21XP4B	70	TA		18¼ x 14¾	22⅞	2000-2500	N	B6-63/B6-203	12L	6.3/60	19.8
21YP4	70	T		20½ x 15¾	23½	500-750	S	B6-63/B6-203	12L	6.3/60	19.8
21YP4A	70	TA		20½ x 15¾	23½	500-750	S	B6-63/B6-203	12L	6.3/60	19.8
21YP4B	70	TA		20½ x 15¾	23½	500-750	N	B6-63/B6-203	12L	6.3/60	19.8
21ZP4	70	T		20½ x 15¾	23½	.....	S	B5-57	12D	6.3/60	19.8
21ZP4A	70	T		20½ x 15¾	23½	500-750	S	B5-57	12N	6.3/60	19.8
21ZP4B	70	TA		20½ x 15¾	23½	500-750	S	B5-57	12N	6.3/60	19.8
21ZP4C	70	TA		20½ x 15¾	23½	500-750	N	B5-57	12N	6.3/60	19.8
22TP4	114	TA, BF		19¾ x 15½	13½	1700-2200	N	B7-208	8HR	6.3/45	23
22ZP4	114	TA, BR		18¾ x 15½	13½	2000-2500	N	B7-208	8HR	6.3/45	23
23ACP4	90	TA, BC		21¾ x 17¾	19½	2000-2500	N	B6-63	12L	6.3/60	18
23AFP4	92	TA, BC		21¾ x 17¾	18¾	2000-2500	N	B6-203	12L	6.3/60	25
23AH4	92	TA		20½ x 16½	18	1700-2500	N	B6-203	12L	6.3/60	22
23AK4	114	TA		20½ x 16½	12⅞	2000-2500	N	B7-208	8JR	6.3/60	22
23AL4	114	TA		20½ x 16½	14½	1700-2500	N	B7-208	8HR	6.3/45	22
23AM4	114	TA		20½ x 16½	14½	1700-2500	N	B7-208	8HR	6.3/30	22
23AN4	92	TA, BC		21¾ x 17¾	18¾	2000-2500	N	B6-63/B6-203	12L	6.3/60	25
23AQ4	114	TA		20½ x 16½	14½	1700-2500	N	B7-208	8HR	6.3/30	19.8
23AR4	110	TA		20½ x 16½	14½	1700-2500	N	B7-208	8HR	6.3/60	22
23ASP4	92	TA		20½ x 16½	17	1700-2500	N	B6-203	12L	6.3/60	22
23ATP4	92	TA, AR, BC		21¾ x 17¾	18¾	2000-2500	N	B6-203/B6-63	12L	6.3/60	25
23AUP4	92	TA		20½ x 16½	18	1700-2500	N	B6-203	12L	6.3/60	25
23AV4	110	TA, AR, BC		21¾ x 17¾	15¾	2000-2500	N	B7-208	8HR	6.3/60	22
23AW4	92	TA		20½ x 16½	18	1700-2500	N	B6-203	12L	6.3/60	22
23AX4	110	TA		20½ x 16½	14½	2000-2500	N	B7-208	8HR	6.3/30	20
23AY4	110	TA, AR, BC		21¾ x 17¾	15¾	2000-2500	N	B7-208	8HR	6.3/30	22
23AZ4	92	TA		20½ x 16½	18	1700-2500	N	B6-203	12L	6.3/30	22
23BP4	110	TA, BC		21¾ x 17¾	14¾	2000-2500	N	B7-208	8HR	6.3/60	22
23BAP4	110	TA, AR, BC		21¾ x 17¾	14¾	2000-2500	N	B7-208	8HR	6.3/60	22
23BCP4	110	TA		20½ x 16½	14¾	1700-2500	N	B7-208	8HR	6.3/30	22
23BDP4	92	TA, AR, BC		21¾ x 17¾	18¾	2000-2500	N	B6-203	12L	6.3/60	22
23BEP4	110	TA, BC		21¾ x 17¾	15¾	2000-2500	N	B7-208	8HR	6.3/30	22
23BEP4A	110	TA, BC		21¾ x 17¾	15¾	2000-2500	N	B7-208	8HR	6.3/30	22
23BGP4	110	TA, BC		21¾ x 17¾	15¾	1700-2500	N	B7-208	8HR	6.3/60	22
23BHP4	110	TA, AR, BC		21¾ x 17¾	15¾	1700-2500	N	B7-208	8HR	6.3/60	22
23BJ4	92	TA		20½ x 16½	18½	1700-2500	N	B6-203	12L	6.3/60	25
23BK4	92	TA, BC		21¾ x 17¾	18¾	1700-2500	N	B6-203	12L	6.3/60	25
23BL4	92	TA, AR, BC		21¾ x 17¾	18¾	1700-2500	N	B6-203	12L	6.3/60	25
23BMP4	92	TA, BC		21¾ x 17¾	18¾	1700-2500	N	B6-203	12L	6.3/60	22
23BN4	110	TA, BC		21¾ x 17¾	15¾	2000-2500	N	B7-208	8HR	6.3/60	22
23BQP4	110	TA, BC		21¾ x 17¾	15¾	2000-2500	N	B7-208	8HR	6.3/45	23
23BR4	110	TA, AR, BC		21¾ x 17¾	13¾	2000-2500	N	B7-208	8JR	6.3/30	22
23BS4	110	TA, AR, BC		21¾ x 17¾	15¾	2000-2500	N	B7-208	8HR	6.3/30	22
23BT4	92	TA, BC		21¾ x 17¾	18¾	2000-2500	N	B6-203	12L	6.3/60	25
23BV4	92	TA, BC		21¾ x 17¾	18¾	2000-2500	N	B6-203	12L	6.3/60	25
23BX4	92	TA, BP		20½ x 16½	18¼	2000-2500	N	B6-203	12L	6.3/60	22
23BY4	110	TA, BC		21¾ x 17¾	13¾	2000-2500	N	B7-208	8JR	6.3/30	22
23BZ4	92	TA		20½ x 16½	18	1700-2500	N	B6-203	12L	8.4/45	22
23CP4	110	TA, BC		21¾ x 17¾	15¾	2000-2500	N	B7-208	8HR	6.3/60	22
23CP4A	110	TA, BC		21¾ x 17¾	15¾	2000-2500	N	B7-208	8HR	6.3/60	23.5
23CAP4	92	TA, BC		21¾ x 17¾	18¾	2000-2500	N	B6-203	12L	8.4/45	22
23CB4	110	TA, AR, BC		21¾ x 17¾	15¾	2000-2500	N	B7-208	8HR	6.3/45	23
23CD4	92	TA, BC		21¾ x 17¾	18¾	2000-2500	N	B6-203	12L	6.3/30	22
23CE4	110	TA		20½ x 16½	14¾	1700-2500	N	B7-208	8HR	6.3/45	22
23CG4	92	TA		20½ x 16½	18	1700-2500	N	B6-203	12L	6.3/45	22
23CM4	110	TA		20½ x 16½	14¾	1700-2500	N	B7-208	8HR	6.3/60	22
23CQP4	114	TA		20½ x 16½	13¾	1700-2500	N	B7-208	8HR	6.3/45	23.5



MAXIMUM RATINGS		TYPICAL OPERATION				REMARKS	Type
Focusing Electrode (Kv)	Accel. Grid (G2) Volts	Anode (Kv)	Focus Electrode Volts	Accel. Grid (G2) Volts	Negative Grid No. 1 or Positive Cathode Voltage for Raster Cutoff		
			Magnet Coil Current in Ma.				
Auto. Es.	550	14	Auto. Es.	300	33-77	Cylindrical Faceplate	21KP4
Auto. Es.	550	14	Auto. Es.	300	33-77		Cylindrical Faceplate
-55 to +1.1	550	16	-65 to +350	300	33-77	Metal Bulb	21WP4
Magnetic	550	16	100 Ma.	300	33-77		21WP4A
Magnetic	550	16	100 Ma.	300	33-77		21WP4A
Magnetic	550	16	100 Ma.	300	33-77		21WP4B
-55 to +1.1	550	16	-64 to +352	300	33-77		21XP4
-55 to +1.1	550	16	-64 to +352	300	33-77		21XP4A
-55 to +1.1	550	16	-64 to +352	300	33-77		21XP4B
-55 to +1.1	550	16	-64 to +352	300	33-77		21YP4
-55 to +1.1	550	16	-64 to +352	300	33-77		21YP4A
-55 to +1.1	550	16	-64 to +352	300	33-77		21YP4B
Magnetic	550	12	95 Ma.	300	33-77		21ZP4
Magnetic	550	16	100 Ma.	300	33-77		21ZP4A
Magnetic	550	16	118 Ma.	300	33-77		21ZP4B
Magnetic	550	16	118 Ma.	300	33-77		21ZP4C
-55 to +1.1	550	18	0 to 500	400	+35 to +72*	Low Anode Voltage	22TP4
-40 to +1.25	700	20	-200 to +200	400	+48 to +82*		22CP4
-55 to +1.1	550	16	0 to 400	300	40-77		23ACP4
-55 to +1.1	550	20	0 to 400	300	40-77		23AFP4
-55 to +1.1	550	18	0 to 400	400	41-99	Tri-Potential Electrostatic Focus	23AHP4
+70m	600	16	0 to 400	500	48-83		23AKP4
-55 to +1.1	550	18	0 to 400	400	41-99		23ALP4
-55 to +1.1	550	18	0 to 400	400	41-99		23AMP4
-55 to +1.1	70	20	0 to 500	50	+40 to +55*	18 Second Heater Warm-up Time	23ANP4
-50 to +1.0	550	18	0 to 400	400	49-99		23AQP4
-55 to +1.1	550	16	0 to 400	300	40-77		23ARP4
-55 to +1.1	550	18	0 to 400	400	41-99		23ASP4
-50 to +1.1	70	20	0 to 500	50	+40 to +55*	23ATP4	
-55 to +1.1	550	18	0 to 400	400	41-99		23AUP4
-55 to +1.1	550	16	0 to 400	300	40-77	23AVP4	
-45 to +1.25	225	20	0 to 400	50	+41 to +59*		23AWP4
-55 to +1.1	550	16	0 to 400	400	42-72	23AXP4	
-55 to +1.1	550	16	0 to 400	300	40-77		23AYP4
-55 to +1.1	550	18	0 to 400	400	41-99	23AZP4	
-55 to +1.1	550	14	0 to 400	450	50-110	23BP4	
-55 to +1.1	550	14	0 to 400	450	50-110		23BAP4
-55 to +1.1	550	16	0 to 400	300	40-77	23BCP4	
-55 to +1.1	700	16	0 to 400	500	+50 to +100*		23BDP4
-55 to +1.1	550	16	0 to 400	300	40-77	23BEP4	
-55 to +1.1	550	16	0 to 400	300	40-77	18 Second Heater Warm-up Time	23BEP4A
-55 to +1.1	70	16	0 to 400	50	+37 to +52*		23BGP4
-55 to +1.1	70	16	0 to 400	50	+37 to +52*	23BHP4	
-45 to +1.25	70	20	0 to 400	50	+41 to +59*		23BJP4
-40 to +1.25	225	20	0 to 400	50	+41 to +59*	23BKP4	
-40 to +1.25	225	20	0 to 400	50	+41 to +59*	23BLP4	
-55 to +1.1	550	16	0 to 400	300	40-77		23BMP4
-55 to +1.1	550	18	-100 to +300	400	60-110	23BNP4	
-55 to +1.1	550	16	0 to 400	300	40-77		23BP4
+70m	600	16	500	500	48-83	Tri-Potential Electrostatic Focus	23BRP4
-55 to +1.1	550	16	0 to 400	300	40-77	18 Second Heater Warm-up Time	23BSP4
-55 to +1.1	550	16	0 to 400	300	40-77		23BTP4
-55 to +1.1	550	20	0 to 400	300	40-77	Internal Magnetic Shielding	23BVP4
-55 to +1.1	550	16	0 to 400	300	35-72		23BXP4
+70m	600	16	0 to 400	500	48-83	18 Sec. Heater Warm-up; Tri-Pot. Es. Focus	23BYP4
-55 to +1.1	550	18	0 to 400	400	41-99	23BZP4	
-55 to +1.1	550	16	0 to 400	300	40-77		23CP4
-55 to +1.1	550	16	0 to 400	300	40-77	23CP4A	
-55 to +1.1	550	16	0 to 400	300	40-77		23CAP4
-55 to +1.1	550	16	0 to 400	300	40-77	23CBP4	
-55 to +1.1	550	16	0 to 400	300	40-77	23CDP4	
-55 to +1.1	550	16	0 to 400	300	40-77		23CEP4
-40 to +1.2	700	16	0 to 400	500	45-95	18 Second Heater Warm-up Time	23CGP4
-55 to +1.1	550	16	0 to 400	300	40-77		23CMP4
-55 to +1.1	550	14	0 to 400	450	50-110	23CQP4	

# Monochrome TV Picture Tubes Data (cont'd)

Type	Defl. Angle and Neck Dia. ⚡	FACEPLATE		OVERALL DIMENSIONS INCHES		External Conductive Coating Capacitance (pF)	** Ion Trap	Base	Basing	Heater Δ/△ Volts/amps	DESIG	
		Clear Tinted Alum. Shield* Anti-Refll.	Faceplate Dimensions	Length	Anode (Kv)							
23CSP4	110	TA, AR, BC	2 1/4 x 1 7/8	13 3/8	2000-2500	N	B7-208	8JR	6.3/30		22	
23CTP4	92	TA, BC	2 1/4 x 1 7/8	18 3/8	2000-2500	N	B6-203	12L	6.3/45		22	
23CUP4	110	TA, AR, BC	2 1/4 x 1 7/8	13 3/8	2000-2500	N	B7-208	8JR	6.3/60		22	
23CVP4	114	TA	2 0 1/2 x 1 6 1/2	12 3/8	2000-2500	N	B7-208	8JR	6.3/30		22	
23CWP4	110	TA	2 0 1/2 x 1 6 1/2	13 3/8	2000-2500	N	B7-208	8JR	6.3/60		22	
23CXP4	110	TA	2 0 1/2 x 1 6 1/2	13 3/8	2000-2500	N	B7-208	8JR	6.3/30		22	
23CZP4	92	TA	2 0 1/2 x 1 6 1/2	18 3/8	2000-2500	N	B6-203	12L	6.3/60		25	
23DP4	110	TA, BC	2 1/4 x 1 7/8	13 3/8	2000-2500	N	B7-208	8JR	6.3/60		22	
23DAP4	94	TA	2 0 1/2 x 1 6 1/2	17 3/8	1700-2500	N	B7-208	8HR	6.3/60		23	
23DBP4	110	TA	2 0 1/2 x 1 6 1/2	14 3/8	2000-2500	N	B7-237/ B7-208	8HR	6.3/60		22	
23DCP4	94	TA	2 0 1/2 x 1 6 1/2	17 3/8	1700-2500	N	B7-208	8HR	6.3/45		23.5	
23DEP4	110	TA-BF	2 1 3/8 x 1 7 3/8	14	1500-2000	N	B7-208	8HR	6.3/30		20	
23DFP4	110	TA-BF	2 0 1/2 x 1 6 1/2	14	1500-2000	N	B7-208	8HR	6.3/30		20	
23DHP4	110	TA-BC	2 1/4 x 1 7/8	14 3/8	2000-2500	N	B7-208	8HR	6.3/30		22	
23DJP4	110	TA-BC	2 1/4 x 1 7/8	14 3/8	2000-2500	N	B7-208	8HR	6.3/30		22	
23DKP4	92	TA-BR	2 0 3/8 x 1 6 5/8	18	1700-2500	N	B6-203	12L	6.3/60		22	
23DLP4	92	TA-BR	2 0 3/8 x 1 6 5/8	18	1700-2500	N	B6-203	12L	6.3/60		22	
23DLP4A	92	TA-BR	2 0 3/8 x 1 6 5/8	18	1700-2500	N	B6-203	12L	6.3/60		22	
23DNP4	92	TA-BC	2 1/4 x 1 7 1/8	18 3/8	2000-2500	N	B6-203	12L	6.3/60		25	
23DQP4	92	TA-BC	2 1/4 x 1 7 1/2	18 1/8	2000-2500	N	B7-208	8HR	6.3/60		25	
23DSP4	92	TA-BR	2 1 1/4 x 1 6 3/8	18 3/8	2000-2500	N	B7-208	8HR	6.3/60		25	
23DSP4A	92	TA-BR	2 1 1/4 x 1 6 3/8	18 3/8	2000-2500	N	B7-208	8HR	6.3/60		25	
23DTP4	92	TA-BR	2 0 3/8 x 1 6 5/8	18 1/2	1700-2500	N	B6-203	12L	6.3/60		25	
23DVP4	114	TA-BR	2 0 3/8 x 1 6 5/8	14 3/8	1700-2500	N	B7-208	8HR	6.3/60		22	
23DVP4A	114	TA-BR	2 0 3/8 x 1 6 5/8	14 3/8	1700-2500	N	B7-208	8HR	6.3/60		22	
23DWP4	94	TA-BR	2 0 3/8 x 1 6 5/8	17 3/8	2000-2500	N	B7-208	8HR	6.3/60		22	
23DYP4	110	TA-BR	2 0 3/8 x 1 6 5/8	14 3/8	2000-2500	N	B7-208	8HR	6.3/60		22	
23DZP4	114	TA-BR	2 0 3/8 x 1 6 5/8	14 3/8	1700-2500	N	B7-208	8HR	6.3/45		22	
23EP4	110	TA, BC	2 1/4 x 1 7 1/8	15 3/8	1700-2500	N	B7-219	8KP	6.3/60		22	
23EAP4	92	TA-BC	2 1/4 x 1 7 1/8	18 3/8	2000-2500	N	B6-203	12L	6.3/45		22	
23ECP4	92	TA-BP	2 0 1/2 x 1 6 1/2	18 3/8	2000-2500	N	B6-203	12L	6.3/60		25	
23EDP4	92	TA-BP	2 0 1/2 x 1 6 1/2	18 3/8	2000-2500	N	B6-203	12L	6.3/60		25	
23EFP4	110	TA-BR	2 0 3/8 x 1 6 5/8	14 3/8	1700-2500	N	B7-208	8HR	6.3/60		22	
23EKP4	92	TA-BR	2 0 3/8 x 1 6 5/8	18	1700-2500	N	B6-203	12L	6.3/45		25	
23ENP4	92	TA-BR	2 0 3/8 x 1 6 5/8	18 1/8	1700-2500	N	B6-203	12L	6.3/60		25	
23EQP4	114	TA-BR	2 0 3/8 x 1 6 5/8	14 1/2	1700-2500	N	B7-208	8HR	6.3/45		23	
23ERP4	114	TA-BR	2 0 3/8 x 1 6 5/8	14 1/2	1700-2500	N	B7-208	8HR	6.3/60		23	
23ESP4	110	TA-AR-BR	2 0 3/8 x 1 6 5/8	14 3/8	2000-2500	N	B7-208	8HR	6.3/45		22	
23ESP4A	110	TA-AR-BR	2 0 3/8 x 1 6 5/8	14 3/8	2000-2500	N	B7-208	8HR	6.3/45		22	
23ETP4	110	TA-BR	2 0 3/8 x 1 6 5/8	14 3/8	1700-2500	N	B7-208	8HR	6.3/60		23	
23EWP4	114	TA-BR	2 0 3/8 x 1 6 5/8	14 3/8	1700-2500	N	B7-208	8HR	6.3/45		22	
23EWP4A	114	TA-BR	2 0 3/8 x 1 6 5/8	14 3/8	1700-2500	N	B7-208	8HR	6.3/45		22	
23EYP4	92	TA-BF	2 1 3/8 x 1 8 3/8	18 3/8	2000-2500	N	B6-203	12L	6.3/60		25	
23EZP4	94	TA-BR	2 0 3/8 x 1 6 5/8	17 3/8	1700-2500	N	B7-208	8HR	6.3/45		23.5	
23FP4	114	TA	2 0 1/2 x 1 6 1/2	13 3/8	1700-2500	N	B7-208	8HR	6.3/60		22	
23FP4A	114	TA	2 0 1/2 x 1 6 1/2	13 3/8	1700-2500	N	B7-208	8HR	6.3/60		23.5	
23FAP4	114	TA-BF	2 1 1/4 x 1 7 3/8	14 1/2	1700-2500	N	B7-208	8HR	6.3/60		22	
23FBP4	92	TA-AR-BR	2 0 3/8 x 1 6 5/8	18 1/8	1700-2500	N	B6-203	12L	6.3/60		25	
23FCP4	110	TA-BR	2 0 3/8 x 1 6 5/8	14 3/8	1700-2500	N	B7-208	8HR	6.3/45		22	
23FDP4	110	TA-BR	2 0 3/8 x 1 6 5/8	14 3/8	1700-2500	N	B7-208	8HR	6.3/45		23	
23FHP4	110	TA-BR	2 0 3/8 x 1 6 5/8	14 3/8	1700-2500	N	B7-208	8HR	6.3/45		23.5	
23FKP4	94	TA-BC	2 1 3/8 x 1 7 3/8	17 3/8	1700-2500	N	B7-208	8HR	6.3/60		23.5	
23FLP4	92	TA-BR	2 0 3/8 x 1 6 5/8	18	1700-2500	N	B6-203	12L	6.3/45		25	
23FMP4	110	TA-BR	2 0 3/8 x 1 6 5/8	14 3/8	1700-2500	N	B7-208	8HR	6.3/45		23	
23FNP4	92	TA-BF	2 1 3/8 x 1 8 3/8	18	2000-2500	N	B6-206	12L	6.3/45		25	
23FRP4	110	TA-BF	2 1 1/4 x 1 7 3/8	14 1/2	1700-2500	N	B7-208	8HR	6.3/45		23	
23FSP4	110	TA-BF	2 1 1/4 x 1 7 3/8	14 3/8	1700-2500	N	B7-208	8HR	6.3/60		23	
23FVP4	110	TA-BR	2 0 3/8 x 1 6 5/8	14 3/8	2000-2500	N	B7-208	8HR	6.3/45		22	
23FVP4A	110	TA-BR	2 0 3/8 x 1 6 5/8	14 3/8	2000-2500	N	B7-208	8HR	6.3/45		22	
23FWP4	92	TA-BR	2 0 3/8 x 1 6 5/8	18	1700-2500	N	B6-63	12L	6.3/45		22	
23FWP4A	92	TA-BR	2 0 3/8 x 1 6 5/8	18	1700-2500	N	B6-203	12L	6.3/45		22	
23GP4	110	TA, BC	2 1 3/8 x 1 7 3/8	15 3/8	2000-2500	N	B7-208	8HR	6.3/60		22	
23GBP4	110	TA-BR	2 0 3/8 x 1 6 5/8	14 3/8	1700-2500	N	B7-208	8HR	6.3/45		23	
23GDP4	114	TA-BR	2 0 3/8 x 1 6 5/8	14 1/2	2000-2500	N	B7-208	8HR	6.3/60		22	

MAXIMUM RATINGS		TYPICAL OPERATION				REMARKS	Type
Focusing Electrode (Kv)	Accel. Grid (G2) Volts	Anode (Kv)	Focus Electrode Volts	Accel. Grid (G2) Volts	Negative Grid No. 1 or Positive Cathode Voltage for Raster Cutoff		
			Magnet Coil Current in Ma.				
+ .70m	600	16	500	500	48-83	18 Sec. Heater Warm-up; Tri-Pot. Es. Focus	23CSP4
- .55 to +1.1	550	16	0 to 400	300	40-77		23CTP4
+ .70m	600	16	500	500	48-83	Tri-Potential Electrostatic Focus	23CUP4
+ .70m	600	16	0 to 400	500	48-83	18 Sec. Heater Warm-up; Tri-Pot. Es. Focus	23CVP4
+ .70	600	16	0 to 400	500	43-78	Tri-Potential Focus	23CWP4
+ .70	600	16	0 to 400	500	43-78	18 Sec. Heater Warm-up; Tri-Pot. Es. Focus	23CX4
- .55 to +1.1	550	20	0 to 400	300	40 to 77	Tri-Potential Electrostatic Focus	23CZP4
+ .70m	600	16	0 to 400	500	48-83		23DP4
- .55 to +1.1	70	18	-100 to +300	50	35-55	23DAP4	23DAP4
- .50 to +1.0	100	18	0 to 500	50	31-49		23DBP4
- .40 to +1.1	70	18	0 to 400	50	35-55	23DCP4	23DCP4
- .55 to +1.1	550	16	0 to 400	400	42-78		23DEP4
- .55 to +1.1	550	16	0 to 400	400	42-78	23DFP4	23DFP4
- .55 to +1.1	700	16	0 to 400	400	36-78		23DHP4
- .55 to +1.1	700	16	0 to 400	400	36-78	23DJP4	23DJP4
- .55 to +1.1	550	16	0 to 400	300	33-59		23DKP4
- .45 to +1.25	225	20	0 to 500	50	36-54	.023" x .625" Tension Band	23DLP4
- .45 to +1.25	225	20	0 to 500	50	36-54		23DLP4A
- .50 to +1.1	60	20	0 to 500	35	25-50	23DNP4	23DNP4
- .55 to +1.1	80	20	-100 to +300	65	41-56		Coated Funnel No Funnel Coating
- .55 to +1.1	80	18	-100 to +300	65	41-56	23DSP4	
- .55 to +1.1	80	18	-100 to +300	65	41-56	23DTP4	23DTP4
- .55 to +1.1	550	20	0 to 400	300	40-76		23DVP4
- .55 to +1.1	550	18	0 to 400	400	46-94	No Funnel Coating. 5/8" Tension Band	23DWP4A
- .50 to +1.0	400	18	0 to 500	200	31-49		23DWP4
- .50 to +1.0	550	18	0 to 500	300	36-54	23DYP4	23DYP4
- .55 to +1.1	550	18	0 to 400	400	46-94		23DZP4
- .55 to +1.1	70	18	0 to 400	50	+39 to +57*	23EP4	23EP4
- .55 to +1.1	550	16	0 to 400	300	35-72		23EAP4
- .50 to +1.0	60	22	0 to 500	35	25-50	23ECP4	23ECP4
- .55 to +1.1	550	20	0 to 500	300	35-72		23EDP4
- .40 to +1.25	70	18	0 to 400	50	34-49	23EFP4	23EFP4
- .55 to +1.1	550	20	0 to 400	400	36-78		23EKP4
- .40 to +1.25	70	20	0 to 400	50	36-54	23ENP4	23ENP4
- .55 to +1.1	550	18	0 to 400	300	28-62		23EQP4
- .55 to +1.1	550	18	0 to 400	300	28-62	23ERP4	23ERP4
- .50 to +1.0	550	18	0 to 500	300	36-54		23ESP4
- .50 to +1.0	550	18	0 to 500	300	36-54	23ESP4A	23ESP4A
- .55 to +1.1	550	18	0 to 400	300	28-62		23ETP4
- .55 to +1.1	550	18	0 to 400	400	46-94	23EWP4	23EWP4
- .55 to +1.1	550	18	-200 to +200	400	48-96		23EWP4A
- .55 to +1.1	60	20	0 to 500	35	25-50	23EYP4	23EYP4
- .55 to +1.1	70	18	0 to 400	50	35-55		23EZP4
- .55 to +1.1	550	14	0 to 400	450	50-110	23FP4	23FP4
- .55 to +1.1	550	14	0 to 400	450	50-110		23FP4A
- .55 to +1.1	550	18	-200 to +200	400	48-96	23FAP4	23FAP4
- .40 to +1.25	70	20	0 to 400	50	36-54		23FBP4
- .40 to +1.25	70	18	0 to 400	50	34-49	23FCP4	23FCP4
- .40 to +1.25	70	18	0 to 400	50	34-52		23FDP4
- .40 to +1.25	70	16	-200 to +200	50	32-50	23FHP4	23FHP4
- .55 to +1.1	650	16	0 to 500	500	45-95		23FKP4
- .55 to +1.1	550	18	-200 to +200	300	37-74	23FLP4	23FLP4
- .55 to +1.1	550	18	0 to 400	300	28-62		23FMP4
- .55 to +1.1	550	20	0 to 500	300	35-72	23FNP4	23FNP4
- .50 to +1.0	60	16	0 to 400	50	35-55		23FRP4
- .50 to +1.0	500	16	0 to 400	400	39-94	23FSP4	23FSP4
- .50 to +1.0	550	18	0 to 500	300	36-54		23FVP4
- .50 to +1.0	550	18	0	300	36-54	23FVP4A	23FVP4A
- .45 to +1.25	225	20	0 to 500	50	36-54		23FWP4
- .45 to +1.25	225	20	0 to 500	50	36-54	5/8" Tension Band	23FWP4A
- .55 to +2.2	550	16	0 to 400	300	33-77		23GP4
- .50 to +1.0	500	16	0 to 400	400	39-94	23GBP4	23GBP4
- .55 to +1.1	550	18	0 to 400	400	36-94		23GDP4

# Monochrome TV Picture Tubes Data (cont'd)

Type	Defl. Angle and Neck Dia. ↓	FACEPLATE Clear Tinted Alum. Shield* Anti-Refll.	OVERALL DIMENSIONS INCHES		External Conductive Coating Capacitance (pf)	** Ion Trap	Base	Basing	Heater▲ Volts/Amps	DESIGN	
			Faceplate Dimensions	Length						Anode (Kv)	
23GHP4	94	TA-BR	20½x 16½	16½	2000-2500	N	B7-208	8HR	6.3/45	23	
23GJP4	110	TA-BR	20½ x 16½	14½	1700-2500	N	B7-208	8HR	6.3/45	22	
23GJPA	110	TA-BR	20½x 16½	14½	1700-2500	N	B7-208	8HR	6.3/45	23	
23GKPA	92	TA-BF	21¾x 17	18½	2000-2500	N	B6-203	12L	6.3/60	22	
23GRP4	92	TA-BF	21¾x 17	18½	2000-2500	N	B6-63	12L	6.3/45	22	
23GSP4	110	TA-BR	20½x 16½	14½	1700-2500	N	B7-208	8HR	6.3/60	23	
23GTP4	110	TA-BR	20½x 16½	14½	1700-2500	N	B7-208	8HR	6.3/60	23	
23GVP4	114	TA-BR	20½ x 16½	14½	2000-2500	N	B7-208	8HR	6.3/45	22	
23GWP4	110	TA-BR	21¼ x 16¼	14¾	2000-2500	N	B7-208	8HR	6.3/45	22	
23GXP4	110	TA-BR	20½ x 16½	14½	2000-2500	N	B7-208	8HR	6.3/60	23	
23HP4	110	TA, BC	21¾ x 17¾	15½	2000-2500	N	B7-208/B7-183	8HR	6.3/60	20	
23HBP4	110	TA-BR	21¾ x 17¾	14	1700-2500	N	B7-208	8HR	6.3/30	22	
23HFP4	110	TA-BR	20½ x 16½	14½	1700-2500	N	B7-208	8HR	6.3/45	23	
23HFP4A	110	TA-BR	20½x 16½	14½	1700-2500	N	B7-208	8HR	6.3/45	23	
23HGP4	110	TA-BR	20½x 16½	14½	1700-2500	N	B7-208	8HR	6.3/45	23	
23HKP4	110	TA-BF	21¾x 17¾	14¾	1700-2500	N	B7-208	8HR	6.3/60	23	
23HMP4	110	TA-BR	20½x 16½	14¾	1700-2500	N	B7-208	8HR	6.3/30	23	
23HQP4	110	TA-BR	20½ x 16½	14¾	1700-2500	N	B7-208	8HR	6.3/45	23	
23HRP4	110	TA-BR	20½x 16½	14¾	2000-2500	N	B7-208	8HR	6.3/45	23.5	
23HTP4	110	TA-BP	20½ x 16½	14¾	2000-2500	N	B7-208	8HR	6.3/30	20	
23HUP4	110	TA-BR	20½x 16½	14½	1700-2500	N	B7-208	8HR	6.3/45	23.5	
23HUP4A	110	TA-BR	20½x 16½	14½	1700-2500	N	B7-208	8HR	6.3/45	23.5	
23HWPA	110	TA-BR	20½x 16½	14½	2000-2500	N	B7-208	8HR	6.3/45	22	
23HWPA4	110	TA-BR	20½x 16½	14½	2000-2500	N	B7-208	8HR	6.3/45	22	
23HXP4	110	TA-AR-BR	20½x 16½	14½	2000-2500	N	B7-208	8HR	6.3/45	23	
23HZP4	110	TA-BR	20½x 16½	14½	1700-2500	N	B7-208	8HR	6.3/30	23	
23JP4	110	TA, BC	21¾ x 17¾	15½	2000-2500	N	B6-214	7FA	6.3/45	22	
23JAP4	110	TA-BR	20½x 16½	14½	1350-2150	N	B7-208	8HR	6.3/30	23	
23JBP4	110	TA-BF	21¾x 17¾	14½	1700-2500	N	B7-208	8HR	6.3/60	23	
23JEP4	110	TA-BR	20½x 16½	14½	1700-2500	N	B7-208	8HR	6.3/45	23	
23JFP4	110	TA-BF	21¾x 17¾	14½	1700-2500	N	B7-208	8HR	6.3/315	23	
23JGP4	110	TA-BR	20½x 16½	14½	1700-2500	N	B7-208	8HR	6.3/45	23.5	
23JLP4	110	TA-BR-AR	20½x 16½	14½	1700-2500	N	B7-208	8HR	6.3/45	23.5	
23KP4	114	TA, BC	20½ x 16½	13½	2000-2500	N	B6-203/B7-208	8JS	6.3/60	20	
23KPA4	114	TA, BC	20½ x 16½	13½	2000-2500	N	B6-204/B7-208	8JS	6.3/60	22	
23MP4	114	TA	20½ x 16½	14½	1700-2500	N	B7-208	8HR	6.3/60	22	
23MP4A	114	TA	20½ x 16½	14½	1700-2500	N	B7-208	8HR	6.3/60	23.5	
23NP4	114	TA	20½ x 16½	14½	1700-2500	N	B7-208	8HR	6.3/60	22	
23RP4	110	TA, BC	21¾ x 17¾	13¾	2000-2500	N	B7-208	8JR	6.3/30	22	
23SP4	110	TA, BC	21¾ x 17¾	15½	2000-2500	N	B7-208	8HR	6.3/30	22	
23TP4	90	TA, BC	21¾ x 17¾	19½	1700-2500	N	B6-63/B6-203	12L	6.3/60	22	
23UP4	110	TA, BC	21¾ x 17¾	15½	2000-2500	N	B7-208	8HR	6.3/45	18	
23VP4	114	TA, BC	20½ x 16½	13¾	2000-2500	N	B7-208	8HR	6.3/30	22	
23WP4	114	TA, BC	20½ x 16½	14½	2000-2500	N	B7-208	8HR	6.3/60	20	
23XP4	92	TA, BC	21¾ x 17¾	18½	2000-2500	N	B6-203	12L	6.3/60	18	
23YP4	92	TA, BC	21¾ x 17¾	18½	2000-2500	N	B6-203	12L	6.3/60	22	
23ZP4	90	TA, BC	21¾ x 17¾	19½	2000-2500	N	B6-63	12L	6.3/60	22	
24AP4	70	T	24	23½	.....	S	B5-57	12D	6.3/60	17.6	
24AP4A	70	T	24	23½	.....	S	B5-57	12D	6.3/60	17.6	
24AP4B	70	C, AR	24	23½	.....	S	B5-57	12D	6.3/60	17.6	
24ADP4	90	TA	22¼x 18¾	21½	2000-2500	S	B5-57	12N	6.3/60	24.2	
24AEP4	90	TA	22¼x 18¾	19½	2000-2500	N	B6-63	12L	6.3/60	22	
24AHP4	110	TA	22¼x 18¾	15½	2000-2500	N	B7-208	8HR	6.3/60	22	
24AJP4	90	TA	22¼x 18¾	19½	2000-2500	N	B6-63	12L	6.3/60	22	
24ALP4	110	TA	22¼x 18¾	15½	2000-2500	N	B7-183	8HR	6.3/60	22	
24AMP4	110	TA	22¼x 18½	15½	2000-2500	N	B6-185	7FA	6.3/60	22	
24ANP4	90	TA	22¼x 18¾	20½	1700-2500	S	B6-63	12L	6.3/60	22	
24AQP4	110	TA	22¼x 18½	15½	1700-2500	N	B7-183	8HR	6.3/45	22	
24ASP4	90	TA	22¼x 18¾	19½	1700-2500	N	B6-63	12L	6.3/30	22	
24ATP4	90	TA	22¼x 18¾	19½	2000-2500	N	B6-63	12L	6.3/60	22	
24AUP4	90	TA	22¼x 18¾	18½	1700-2500	N	B6-63	12L	6.3/60	22	
24AVP4	110	TA	22¼x 18¾	14½	1700-2500	N	B7-208	8JK	2.35/60	20	
24AWP4	110	TA	22¼x 18½	14½	2000-2500	N	B7-183	8HR	6.3/60	22	
24AXP4	110	TA	22¼x 18½	15½	1700-2500	N	B7-183/B7-208	8HR	6.3/30	22	
24BP4	70	T	22¼	24½	.....	S	B6-63	12M	6.3/60	17.6	

MAXIMUM RATINGS		TYPICAL OPERATION				REMARKS	Type
Focusing Electrode (Kv)	Accel. Grid (G2) Volts	Anode (Kv)	Focus Electrode Volts Magnet Coil Current in Ma.	Accel. Grid (G2) Volts	Negative Grid No. 1 or Positive Cathode Voltage for Raster Cutoff		
-50 to +1.0	400	18	0 to 400	200	+31 to +49*	Welded Tension Band	23GHP4
-40 to +1.25	70	18	0 to 400	50	+32 to +50*		23GJP4
-40 to +1.25	70	18	0 to 400	50	+32 to +50*		23GKP4
-55 to +1.1	550	16	0 to 400	300	35-72		23GRP4
-55 to +1.1	550	16	0 to 400	300	35-72		
-55 to +1.1	550	18	0 to 400	300	28-62	Mounting Lugs	23GSP4
-55 to +1.1	550	18	0 to 400	300	28-62		23GTP4
-50 to +1.1	55	18	0 to 500	45	35-50		23GVP4
-40 to +1.25	60	18	-50 to +350	50	33-45		23GWP4
-55 to +1.1	550	16	0 to 400	300	35-72		23GXP4
-50 to +2.0	550	16	0 to 400	300	40-77		23HP4
-55 to +1.1	550	16	0 to 400	300	35-72		23HBP4
-50 to +1.0	500	16	0 to 400	400	39-94		23HFP4
-55 to +1.1	550	18	0 to 400	300	28-62		23HPP4A
-55 to +1.1	550	18	0 to 400	300	28-62		23HQP4
-50 to +1.0	250	16	0 to 400	150	36-54	Mounting Lugs	23HKP4
-55 to +1.1	550	18	0 to 400	300	28-62		23HMP4
-50 to +1.0	500	16	0 to 400	400	39-94		23HQP4
-55 to +1.1	60	18	0 to 400	30	+30 to +45*		23HRP4
-55 to +1.1	550	16	0 to 400	400	42-72		23HTP4
-40 to +1.25	60	18	0 to 400	30	+22 to +45*	Welded Tension Band	23HUP4
-40 to +1.25	60	18	0 to 400	30	+22 to +45*		23HUP4A
-55 to +1.1	70	16	0 to 400	50	+35 to +55*		23HWP4
-55 to +1.1	70	16	0 to 400	50	+35 to +55*	Welded Tension Band	23HWP4A
-55 to +1.1	550	18	0 to 400	300	28-62		23HXP4
-55 to +1.1	550	18	0 to 400	300	28-62		23HZP4
-55 to +1.1	70	16	250	50	+40 to +55*		23JP4
-55 to +1.25	70	18	-200 to +200	50	+32 to +50*		23JAP4
-50 to +1.0	500	16	0 to 400	400	39-94		23JBP4
-55 to +1.1	550	18	0 to 400	300	+28 to +62*		23JEP4
-50 to +1.0	60	16	0 to 400	50	35-55	Welded Tension Band	23JFP4
-40 to +1.25	60	18	0 to 400	30	+22 to +45*		23JGP4
-40 to +1.25	60	18	0 to 400	30	+22 to +45*		23JLP4
-50 to +1.0	700	16.5	250	450	33-77		23KP4
-50 to +1.0	700	18	250	450	33-77		23KP4A
-55 to +1.1	550	18	0 to 400	400	41-99	Tri-Potential Electrostatic Focus	23MP4
-55 to +1.1	550	18	0 to 400	400	41-99		23MP4A
-55 to +1.1	70	18	0 to 400	50	+39 to +54*		23NP4
+70m	600	16	0 to 400	500	48-83		23RP4
-55 to +1.1	550	16	0 to 400	300	40-77		23SP4
-50 to +1.0	550	16	0 to 450	300	33-77	Low Anode Voltage 18 Second Heater Warm-up Time	23TP4
-55 to +1.1	550	16	0 to 400	300	40-77		23UP4
-55 to +1.1	550	14	0 to 400	450	50-110		23VP4
-50 to +2.0	550	16	0 to 400	300	40-77		23WP4
-55 to +1.1	550	16	0 to 400	300	40-77		23XP4
-55 to +1.1	550	16	0 to 400	300	40-77	Metal Bulb	23YP4
-50 to +1.1	70	18	0 to 500	50	+40 to +55*		23ZP4
Magnetic	450	15	114 Ma.	300	33-77		24AP4
Magnetic	450	15	114 Ma.	300	33-77		24AP4A
Magnetic	450	15	114 Ma.	300	33-77		24AP4B
Magnetic	660	18	125 Ma.	300	33-77		24ADP4
-55 to +1.1	550	18	-50 to +350	300	33-77		24AEP4
-55 to +1.1	550	16	-50 to +350	300	33-77		24AFP4
-55 to +1.1	70	18	0 to 350	50	35-50		24AJP4
-55 to +1.1	550	17	0 to 500	300	33-77		24ALP4
-55 to +1.1	550	16	0 to 400	300	40-77		24AMP4
-55 to +1.1	550	18	-72 to +396	300	40-77		24ANP4
-55 to +1.1	550	16	0 to 400	300	40-77		24AQP4
-55 to +1.1	550	18	0 to 400	300	40-77		24ASP4
-55 to +1.1	75	18	0 to 400	50	+39 to +57*		24ATP4
-55 to +1.1	550	18	-75 to +400	300	40-77	2.35 Volt Heater	24AUP4
-55 to +1.1	550	16	-100 to +300	300	40-77		24AVP4
-55 to +1.1	550	16	0 to 400	300	33-77		24AWP4
-55 to +1.1	550	16	0 to 400	300	40-77		24AXP4
-55 to +1.1	550	14	-56 to +310	300	33-77		24BP4

# Monochrome TV Picture Tubes Data (cont'd)

Type	Defl. Angle and Neck Dia. ♦	FACEPLATE		OVERALL DIMENSIONS INCHES		External Coating Capacitance (pf)	** Ion Trap	Base	Basing	Heater/▲ Volts/△	DESIGN	
		Clear Tinted Alum. Shield* Anti-Refll.	Faceplate Dimensions	Length	Anode (Kv)							
24BAP4	110	TA	22 <sup>1</sup> / <sub>4</sub> × 18 <sup>1</sup> / <sub>2</sub>	15 <sup>3</sup> / <sub>8</sub>	1700-2500	N	B7-183/B7-208	8HR	6.3/60	22		
24BCP4	90	TA-BP	22 <sup>1</sup> / <sub>4</sub> × 18 <sup>1</sup> / <sub>2</sub>	19 <sup>3</sup> / <sub>8</sub>	2000-2500	N	B6-203	12L	6.3/60	22		
24BEP4	110	TA	22 <sup>1</sup> / <sub>4</sub> × 18 <sup>1</sup> / <sub>2</sub>	14 <sup>1</sup> / <sub>4</sub>	1700-2500	N	B7-208	8KW	6.3/60	20		
24CP4	90	T	22 <sup>1</sup> / <sub>4</sub> × 18 <sup>1</sup> / <sub>2</sub>	21 <sup>1</sup> / <sub>8</sub>	2000-2500	S	B5-57	12N	6.3/60	22		
24CP4A	90	TA	22 <sup>1</sup> / <sub>4</sub> × 18 <sup>1</sup> / <sub>2</sub>	21 <sup>1</sup> / <sub>8</sub>	2000-2500	S	B5-57	12N	6.3/60	22		
24CP4B	90	TA	22 <sup>1</sup> / <sub>4</sub> × 18 <sup>1</sup> / <sub>2</sub>	21 <sup>1</sup> / <sub>8</sub>	2000-2500	N	B5-57	12N	6.3/60	22		
24DP4	90	T	22 <sup>1</sup> / <sub>4</sub> × 18 <sup>1</sup> / <sub>2</sub>	21 <sup>1</sup> / <sub>8</sub>	2000-2500	S	B6-63	12L	6.3/60	22		
24DP4A	90	TA	22 <sup>1</sup> / <sub>4</sub> × 18 <sup>1</sup> / <sub>2</sub>	21 <sup>1</sup> / <sub>8</sub>	2000-2500	S	B6-63	12L	6.3/60	22		
24QP4	90	T	22 <sup>1</sup> / <sub>4</sub> × 18 <sup>1</sup> / <sub>2</sub>	21 <sup>1</sup> / <sub>8</sub>	500-750	S	B5-57	12N	6.3/60	19.8		
24TP4	90	TA	22 <sup>1</sup> / <sub>4</sub> × 18 <sup>1</sup> / <sub>2</sub>	21 <sup>1</sup> / <sub>8</sub>	250-2500	S	B5-57	12N	6.3/60	22		
24VP4	90	T	22 <sup>1</sup> / <sub>4</sub> × 18 <sup>1</sup> / <sub>2</sub>	21 <sup>1</sup> / <sub>8</sub>	2000-2500	S	B5-57	12N	6.3/60	24.2		
24VP4A	90	TA	22 <sup>1</sup> / <sub>4</sub> × 18 <sup>1</sup> / <sub>2</sub>	21 <sup>1</sup> / <sub>8</sub>	2000-2500	S	B5-57	12N	6.3/60	24.2		
24XP4	90	T	22 <sup>1</sup> / <sub>4</sub> × 18 <sup>1</sup> / <sub>2</sub>	21 <sup>1</sup> / <sub>8</sub>	.....	S	B5-57	12D	6.3/60	22		
24YP4	90	TA	22 <sup>1</sup> / <sub>4</sub> × 18 <sup>1</sup> / <sub>2</sub>	21 <sup>1</sup> / <sub>8</sub>	2000-2500	S	B6-63	12L	6.3/60	22		
24ZP4	90	TA	22 <sup>1</sup> / <sub>4</sub> × 18 <sup>1</sup> / <sub>2</sub>	21 <sup>1</sup> / <sub>8</sub>	2000-2500	N	B6-63	12L	6.3/60	22		
25DP4	110	TA-BF	23 <sup>1</sup> / <sub>4</sub> × 18 <sup>1</sup> / <sub>2</sub>	15 <sup>1</sup> / <sub>4</sub>	2000-2500	N	B7-208	8HR	6.3/30	22		
25EP4	110	TA-BF	23 <sup>1</sup> / <sub>4</sub> × 18 <sup>1</sup> / <sub>2</sub>	15 <sup>1</sup> / <sub>4</sub>	2000-2500	N	B7-208	8HR	6.3/30	22		
25HP4	110	TA-BF	23 <sup>1</sup> / <sub>4</sub> × 18 <sup>1</sup> / <sub>2</sub>	15 <sup>1</sup> / <sub>4</sub>	2000-2500	N	B7-208	8HR	6.3/45	23		
25JP4	110	TA	22 <sup>3</sup> / <sub>8</sub> × 18 <sup>1</sup> / <sub>2</sub>	15 <sup>1</sup> / <sub>4</sub>	2000-2500	N	B7-208	8HR	6.3/30	22		
25KP4	110	TA-AR-BP	22 <sup>3</sup> / <sub>8</sub> × 18 <sup>1</sup> / <sub>2</sub>	16	2000-2500	N	B7-208	8HR	6.3/30	22		
25LP4	110	TA-BP	22 <sup>3</sup> / <sub>8</sub> × 18 <sup>1</sup> / <sub>2</sub>	16 <sup>1</sup> / <sub>4</sub>	2000-2500	N	B7-183	8HR	6.3/60	22		
25TP4	110	TA-BP	22 <sup>1</sup> / <sub>2</sub> × 18 <sup>1</sup> / <sub>2</sub>	15 <sup>1</sup> / <sub>4</sub>	2000-2500	N	B7-208	8HR	6.3/60	22		
27AP4	90	T, AR	25 <sup>1</sup> / <sub>2</sub> × 19 <sup>1</sup> / <sub>2</sub>	21 <sup>1</sup> / <sub>8</sub>	.....	S	B6-63	12M	6.3/60	19.8		
27ABP4	110	TA-BP	25 <sup>1</sup> / <sub>2</sub> × 20 <sup>1</sup> / <sub>2</sub>	17 <sup>1</sup> / <sub>8</sub>	2000-2500	N	B7-208	8HR	6.3/60	22		
27ACP4	90	TA-BP	25 <sup>1</sup> / <sub>2</sub> × 20 <sup>1</sup> / <sub>2</sub>	21 <sup>1</sup> / <sub>4</sub>	2000-2500	N	B6-203	12L	6.3/60	25		
27ADP4	110	TA-BP	25 <sup>1</sup> / <sub>2</sub> × 20 <sup>1</sup> / <sub>2</sub>	17 <sup>1</sup> / <sub>8</sub>	2000-2500	N	B7-208	8HR	6.3/60	22		
27AEP4	110	TA	25 <sup>1</sup> / <sub>2</sub> × 20 <sup>1</sup> / <sub>2</sub>	17 <sup>1</sup> / <sub>8</sub>	2000-2500	N	B7-208	8HR	6.3/30	22		
27AFP4	110	TA-BP	25 <sup>1</sup> / <sub>2</sub> × 20 <sup>1</sup> / <sub>2</sub>	17 <sup>1</sup> / <sub>8</sub>	2000-2500	N	B7-208	8HR	6.3/30	22		
27AGP4	110	TA-AR-BP	25 <sup>1</sup> / <sub>2</sub> × 20 <sup>1</sup> / <sub>2</sub>	17 <sup>1</sup> / <sub>8</sub>	2000-2500	N	B7-208	8HR	6.3/60	22		
27EP4	90	TA	25 <sup>1</sup> / <sub>2</sub> × 20 <sup>1</sup> / <sub>2</sub>	23 <sup>1</sup> / <sub>4</sub>	.....	S	B5-57	12D	6.3/60	22		
27GP4	90	T	25 <sup>1</sup> / <sub>2</sub> × 20 <sup>1</sup> / <sub>2</sub>	23 <sup>1</sup> / <sub>4</sub>	.....	S	B5-57	12D	6.3/60	24.8		
27LP4	90	TA	25 <sup>1</sup> / <sub>2</sub> × 20 <sup>1</sup> / <sub>2</sub>	24 <sup>1</sup> / <sub>4</sub>	200-400	S	B5-57	12N	6.3/60	24.2		
27MP4	90	TA, AR	25 <sup>1</sup> / <sub>2</sub> × 19 <sup>1</sup> / <sub>2</sub>	22 <sup>3</sup> / <sub>8</sub>	.....	N	B5-57	12D	6.3/60	19.8		
27NP4	90	T	25 <sup>1</sup> / <sub>2</sub> × 20 <sup>1</sup> / <sub>2</sub>	23	500-2500	S	B5-57	12N	6.3/60	19.8		
27RP4	90	TA	25 <sup>1</sup> / <sub>2</sub> × 20 <sup>1</sup> / <sub>2</sub>	23 <sup>1</sup> / <sub>4</sub>	500-2500	S	B5-57	12N	6.3/60	22		
27RP4A	90	TA	25 <sup>1</sup> / <sub>2</sub> × 20 <sup>1</sup> / <sub>2</sub>	23 <sup>1</sup> / <sub>4</sub>	500-2500	N	B5-57	12N	6.3/60	20		
27SP4	90	TA	25 <sup>1</sup> / <sub>2</sub> × 20 <sup>1</sup> / <sub>2</sub>	23 <sup>1</sup> / <sub>4</sub>	500-750	S	B6-63	12L	6.3/60	22		
27UP4	90	T	25 <sup>1</sup> / <sub>2</sub> × 20 <sup>1</sup> / <sub>2</sub>	23 <sup>1</sup> / <sub>4</sub>	500-750	S	B6-63	12L	6.3/60	22		
27VP4	90	TA	25 <sup>1</sup> / <sub>2</sub> × 20 <sup>1</sup> / <sub>2</sub>	21 <sup>1</sup> / <sub>4</sub>	2000-2500	N	B6-63	12L	6.3/60	19.8		
27XP4	90	TA	25 <sup>1</sup> / <sub>2</sub> × 20 <sup>1</sup> / <sub>2</sub>	20 <sup>1</sup> / <sub>4</sub>	1700-2500	N	B6-203	12L	6.3/60	23		
27YP4	90	TA-BP	25 <sup>1</sup> / <sub>2</sub> × 20 <sup>1</sup> / <sub>2</sub>	21 <sup>1</sup> / <sub>4</sub>	2000-2500	N	B6-63	12L	6.3/60	25		
27ZP4	110	TA	25 <sup>1</sup> / <sub>2</sub> × 20 <sup>1</sup> / <sub>2</sub>	17 <sup>1</sup> / <sub>8</sub>	2000-2500	N	B7-208	8HR	6.3/60	22		
30BP4	90	T	30 <sup>1</sup> / <sub>8</sub>	23 <sup>1</sup> / <sub>4</sub>	.....	S	B5-57	12D	6.3/60	33		

Notes—Page 533

Basing Diagrams—Page 535

## Monochrome Check Tubes

Type	Heater E/If Volts Amps	Face		External Coating Capacitance (pf)	Focus	Defl. Angle and Neck Diam. ♦	Anode Volts (KV) Max.	Basing	Ion Trap Mag.	Nominal Length (In.)
		Clear Anti- Refll. Alum. Tinted	Round or Rect.							
5AXP4	6.3/60	C	○	No	Auto	53	19.8	12S	N	10 <sup>1</sup> / <sub>2</sub>
8XP4	6.3/60	T	□	No	Auto	90	22	12S	N	11 <sup>1</sup> / <sub>2</sub>
8YP4	6.3/60	T	□	No	Auto	110	22	7FG	N	8 <sup>1</sup> / <sub>4</sub>
12DMP4	6.3/60	TA, TB	□	No	Auto	110	22	8HR	N	9 <sup>1</sup> / <sub>2</sub>

These four types have self-focusing guns, do not require ion trap magnets, and have no external coating. One of them can be used as a TV receiver check tube for almost any of

the listed picture tube types. Additional technical information on these tubes and on their application in TV receiver servicing is available upon request.

MAXIMUM RATINGS		TYPICAL OPERATION				REMARKS	Type
Focusing Electrode (Kv)	Accel. Grid (G2) Volts	Anode (Kv)	Focus Electrode Volts Magnet Coil Current in Ma.	Accel. Grid (G2) Volts	Negative Grid No. 1 or Positive Cathode Voltage for Raster Cutoff		
- .55 to +1.1	70	20	0 to 400	64	+47 to +63*	24BP4	
- .50 to +1.1	550	18	0 to 400	400	36-94	24BCP4	
- .55 to +1.1	550	16	-100 to +300	300	40-77	24BEP4	
Magnetic	550	18	100 Ma.	300	33-77	24CP4	
Magnetic	550	18	100 Ma.	300	33-77	24CP4A	
Magnetic	550	18	100 Ma.	300	33-77	24CP4B	
- .55 to +1.1	550	18	-72 to +396	300	33-77	24DP4	
- .55 to +1.1	550	18	-72 to +396	300	33-77	24DP4A	
Magnetic	550	16	100 Ma.	300	33-77	24QP4	
Magnetic	550	18	100 Ma.	300	33-77	24TP4	
Magnetic	660	20	125 Ma.	300	33-77	24VP4	
Magnetic	660	20	125 Ma.	300	33-77	24VP4A	
Magnetic	550	18	125 Ma.	300	33-77	24XP4	
- .55 to +1.1	550	18	-72 to +396	300	33-77	24YP4	
- .55 to +1.1	550	16	0 to 500	300	33-77	24ZP4	
- .55 to +1.1	700	16	-200 to +200	300	35-72	25DP4	
- .55 to +1.1	700	16	-200 to +200	300	35-72	25EP4	
- .50 to +1.0	60	16	0 to 400	50	35-55	25HP4	
- .55 to +1.1	700	16	-200 to +200	300	35-72	25JP4	
- .55 to +1.1	700	16	-200 to +200	300	35-72	25KP4	
- .55 to +1.1	550	18	0 to 400	400	36-94	25LP4	
- .55 to +1.1	550	18	0 to 400	400	36-94	25TP4	
- .55 to +1.1	550	15	-60 to +300	300	33-77	27AP4	
- .55 to +1.1	550	18	0 to 400	300	35-72	27ABP4	
- .55 to +1.1	550	18	0 to 400	400	48-96	27ACP4	
- .55 to +1.1	550	18	0 to 400	300	37-74	27ADP4	
- .55 to +1.1	550	18	0 to 400	300	40-77	27AEP4	
- .55 to +1.1	550	18	0 to 400	300	37-74	27AFP4	
- .55 to +1.1	550	18	0 to 400	300	35-74	27AGP4	
Magnetic	550	16	118 Ma.	300	33-77	27EP4	
Magnetic	550	20	125 Ma.	300	33-77	27GP4	
Magnetic	660	20	148 Ma.	300	33-77	27LP4	
Magnetic	550	16	110 Ma.	300	42-78	27MP4	
Magnetic	550	16	95 Ma.	300	33-77	27NP4	
Magnetic	550	20	125 Ma.	300	33-77	27RP4	
Magnetic	550	20	125 Ma.	300	33-77	27RP4A	
- .55 to +1.1	550	18	-72 to +396	300	33-77	27SP4	
- .55 to +1.1	550	16	0 to 396	300	33-77	27UP4	
- .55 to +1.1	550	16	-72 to +396	300	33-77	27VP4	
- .55 to +1.1	550	18	0 to 400	400	41-99	27XP4	
- .55 to +1.1	550	18	0 to 450	300	28-72	27YP4	
- .55 to +1.1	550	18	0 to 400	300	40-77	27ZP4	
*Magnetic	450	22	95 Ma.	300	33-77	Metal Bulb 30BP4	

## Notes:

◆ 94°, 110° and 114° types have a nominal neck diameter of 1 1/4". All other magnetic deflection tube types have nominal neck diameter of 1 3/4". Color tubes listed have nominal neck diameter of 2" for the round types and 1 1/4" for the rectangular types. Unless otherwise indicated in "Remarks" Column.

▲ All Sylvania television picture tubes (except as noted in the Remarks Column) feature controlled heater warm-up time of 11 seconds for operation in receivers employing series heater strings.

■ Cathode drive service.

● Design Maximum Ratings are limiting values that should not be exceeded under the worst probable operating conditions.

### \*\* Ion Trap

**N** - No Magnet  
**S** - Single Magnet  
**D** - Double Magnet  
**I** - Internal Magnet

△ Does not include the dynamic convergence component.

m Maximum

notes continued on next page

## Notes: (cont'd)

### \*IMPLOSION PROTECTION

#### **TB—Tension band**

Employs a metal band which places the faceplate in proper compression. Currently used on small screen types for portable television sets.

#### **BC—Bonded shield (contoured glass cap)**

Features a permanently bonded-on wrap-around panel that provides added viewing safety. Mounting ears are located on the four corners of the bonded shield to allow mounting of the tube, thereby eliminating the use of complicated mounting devices. This design is currently available in the 19" and 23" sizes only.

#### **BP—Bonded shield (glass plate)**

This design is adaptable to any size and shape of bulb. The panel, which fits only over the frontal surface, is molded, cut to size, shaped, and then bonded to the tube by Sylvania. Currently popular tube sizes incorporating this type of Bonded Shield are 16, 19, 21, 23 and 27".

#### **BF—Bonded metal frame (shelbond)**

Features a resin-filled steel shell encasing the critical area of the picture tube. Integral mounting ears on the shell eliminate the need for additional brackets. Bonded Frame is available in 11, 12, 19, 23 and 25" designs. Other tube sizes utilizing this design may be adopted.

#### **BR—Bonded metal rim plus tension band (Kimcode)**

The new design employs a special heavy weight bulb with a rim band secured around the edge of the tube. A tension band, joined by a clamp, fits directly over the rim band, placing the faceplate in proper compression. This design is available in 16, 19, and 23" tube sizes, and other tube sizes utilizing this design may be adopted. There are versions in which the tension band is welded, and these are generally interchangeable with the clamped types.

Certain types employ mounting ears on the four corners of the rim to allow mounting of the tube, thereby eliminating the use of complicated mounting devices. Several versions of mounting brackets exist, and specific type numbers should be specified to assure correct interchangeability.

#### **BL—Bonded laminated plastic shield**

Incorporates a laminated plastic sheet which is coated with a plasticizer and vacuum-formed directly on the face and partly down the sides of the tube. Used only on a few small tubes for portables.

#### **Nonbonded**

Has a standard glass protective plate mounted in cabinet in front of the tube. This may allow moisture and dust particles to collect on the tube faceplate and inner surface of the safety panel. The protective plate gives the regular tube a total of four reflective surfaces compared to the bonded types which have only two reflective surfaces—a total of 50% more reflection in the regular tube and separate safety plate combination.



# Basing Diagrams (monochrome tubes)

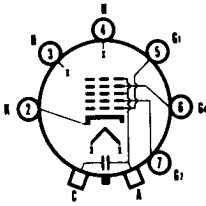

7FA

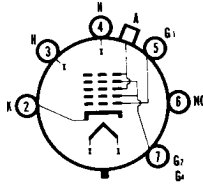

7FG

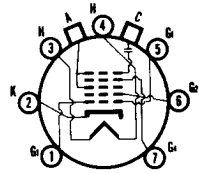

7GR

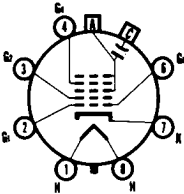

8HR

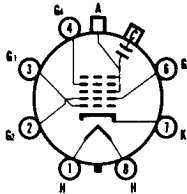

8JK

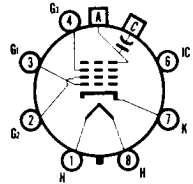

8JN

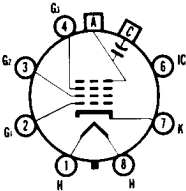

8JR

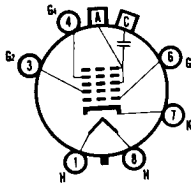

8JS

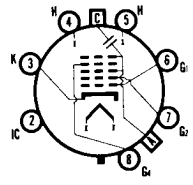

8KP

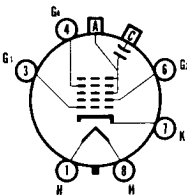

8KW

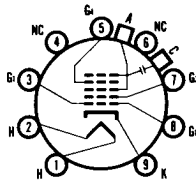

9RS

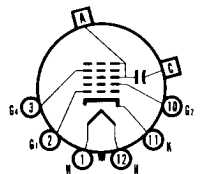

12AB

# Basing Diagrams (continued)

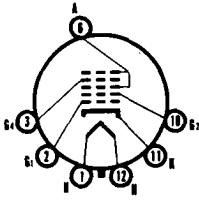

12AD

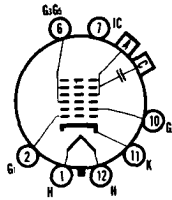

12AJ

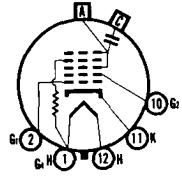

12AT

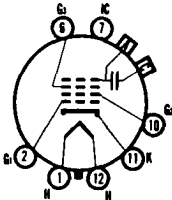

12C

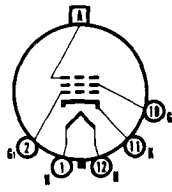

12D

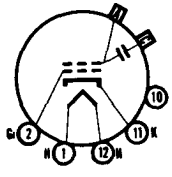

12G

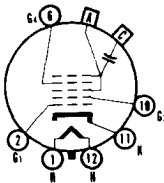

12L

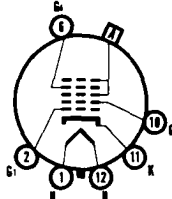

12M

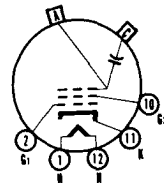

12N

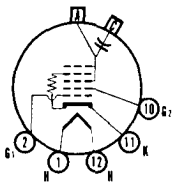

12P

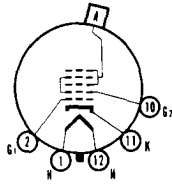

12S

## basing diagram symbols

- |                              |                            |  |                        |
|------------------------------|----------------------------|--|------------------------|
| <b>A</b> Anode               | <b>C</b> Conductive        | <b>H</b> Heater                            | <b>■</b> Locating Lug  |
| <b>A1</b> First Anode        | <b>j</b> Coating           | <b>IC</b> Internal Connection (Do Not Use) | <b>□</b> Bulb Terminal |
| <b>A2</b> Second Anode, etc. | <b>G1</b> Grid No. 1       | <b>K</b> Cathode                           |                        |
|                              | <b>G2</b> Grid No. 2, etc. |  |                        |

# TV PICTURE TUBE REPLACEMENT GUIDES

	<b>Page</b>
<b>Color Picture Tubes</b> .....	<b>538</b>
<b>Monochrome Picture Tubes</b> .....	<b>539</b>
<b>Replacement Notes</b> .....	<b>544</b>
<b>Installation and Handling of TV Picture Tubes and Large Cathode Ray Tubes.</b>	<b>545</b>

# TV Picture Tube Replacement Guides

## COLOR PICTURE TUBES

Type	SYLVANIA* Replacement	Replacement Classification	Type	SYLVANIA* Replacement	Replacement Classification
<b>11" Types</b>			490HB22	} <b>19EXP22</b>	G, H
11SP22	} <b>11WP22</b>	Direct	490JB22		
11WP22			490LB22		
<b>15" Types</b>				<b>21" Types</b>	
15ACP22	<b>15ACP22</b>	Direct	21AXP22A	} <b>21FBP22A</b>	B
RE15LP22	} <b>15LP22</b>	Direct	C21AXP22A		
H15LP22			21CYP22		
C15LP22			C21CYP22A		
15LP22			RE21FBP22A	} <b>21FBP22A</b>	Direct
RE15NP22	} <b>15NP22</b>	Direct	C21FBP22A		
H15NP22			H21FBP22A		
C15NP22			AN21FBP22A		
15K P22			OC21FBP22A		
15NP22			21FBP22A		
15XP22					H21GUP22
<b>19" Types</b>			H21GVP22	<b>21FJP22A</b>	G
RE19EXP22	} <b>19EXP22</b>	Direct	RE21FJP22A	} <b>21FJP22A</b>	Direct
C19EXP22			C21FJP22A		
H19EXP22			H21FJP22A		
AN19EXP22			AN21FJP22A		
OC19EXP22			OC21FJP22A		
19EXP22			21FJP22A		
REA19EYP22			RE21FKP22		
RE19EYP22	21FKP22		<b>22" Types</b>		
C19EYP22	} <b>19EYP22</b>	Direct	RE22JP22	} <b>22JP22</b>	Direct
H19EYP22			C22JP22		
AN19EYP22			22JP22		
OC19EYP22			REA22JP22		
19EYP22			CA22JP22		
19GSP22			H22JP22		
RE19FMP22			<b>19FMP22</b>		
19FXP22	<b>19EYP22</b>	Direct	C22LP22		
H19GVP22	<b>19EXP22</b>	G	22LP22		
H19GWP22	<b>19EYP22</b>	G	22QP22	<b>22JP22</b>	Direct
19GXP22	<b>19EXP22</b>	G, H	22RP22	<b>22KP22</b>	Direct
19GYP22	<b>19EXP22</b>	H	22SP22	<b>22JP22</b>	Direct
19GZP22	<b>19EYP22</b>	Direct	RE22KP22	} <b>22KP22</b>	Direct
19HBP22	<b>19FMP22</b>	Direct	C22KP22		
19HFP22	<b>19EYP22</b>	G	22KP22		
19HCP22	} <b>19HCP22</b>	Direct	22UP22	} <b>22UP22</b>	Direct
19HJP22			22XP22		
19HKP22			22ADP22		
490AJB22	<b>19EYP22</b>	G	22AGP22		
490EB22	} <b>19EXP22</b>	G, H	22AHP22		
490FB22			22YP22	<b>22JP22</b>	Direct
490GB22					
19JBP22	<b>19EXP22</b>	Direct			

Type	SYLVANIA* Replacement	Replacement Classification	Type	SYLVANIA* Replacement	Replacement Classification			
<b>23" Types</b>								
23EGP22 23EGP22A	23EGP22A	Direct	RE25CP22 C25CP22 25CP22 REA25CP22 CA25CP22	25CP22	Direct			
23EGP22 23EGP22A			25AP22A			25FP22 25FP22A	25BP22A	Direct
<b>25" Types</b>	25ABP22	25CP22				Direct		
25ADP22 25AGP22 25BCP22	25AJP22	Direct	25AEP22			25BP22A	Direct	
25AFP22 25AQP22			25AP22A			Direct	25R22 25S22	25BP22A 25AP22A
25AJP22 25ASP22	25AJP22	Direct		25ACP22 25ALP22 25AYP22 25UP22/ A63-16X	25UP22		Direct	
RE25AP22A C25AP22A H25AP22A AN25AP22A OC25AP22A 25AP22A			25AP22A	Direct		25AKP22 25AMP22		25UP22
RE25BP22A C25BP22A H25BP22A AN25BP22A OC25BP22A 25BP22A	25BP22A	Direct			25VP22 25WP22	25AP22A	Direct	
					H25XP22 H25YP22 25ZP22			25AP22A 25BP22A 25AP22A

**MONOCHROME PICTURE TUBES**

Type	SYLVANIA* Replacement	Replacement Classification	Type	SYLVANIA* Replacement	Replacement Classification
9TP4	9TP4	Direct	12CBP4	12CBP4	Direct
9YP4	9YP4	Direct	12CDP4	12CDP4	Direct
11CP4	11CP4	Direct	12CEP4	12CEP4	Direct
11GP4	11GP4	Direct	12CGP4	12CGP4	Direct
11JP4	11JP4	Direct	12CSP4	12CSP4	Direct
12BEP4	12BEP4	Direct	12CTP4	12CTP4	Direct
12BGP4	12BGP4	Direct	12DKP4	12DKP4	Direct
12BKP4	12BKP4	Direct	12DQP4	12DQP4	Direct
12BLP4	12BKP4	Direct	13AP4	13AP4	Direct
12BMP4	12CDP4	Direct	13DP4	13DP4	Direct
12BNP4	12CGP4	Direct	14NP4	14WP4	A
12BQP4	12BQP4	Direct	14NP4A	14WP4	A
12BTP4	12BTP4	Direct	14RP4	14WP4	A
12BUP4	12BUP4	Direct	14RP4A	14WP4	A
12BZP4	12BZP4	Direct	14SP4	14WP4	A

## TV PICTURE TUBE REPLACEMENT GUIDES (cont'd)

Type	SYLVANIA* Replacement	Replacement Classification	Type	SYLVANIA* Replacement	Replacement Classification
14WP4	14WP4	Direct	17CDP4	17CDP4	Direct
SG14WP4	14WP4	Direct	17CFP4	17CFP4	Direct
14XP4	14XP4A	Direct	17CKP4	17DSP4	Direct
14XP4A	14XP4A	Direct	17CLP4	17BJP4	A
14ZP4	14WP4	Direct	17CNP4	17CNP4	Direct
15ADP4	15ADP4	Direct	17CRP4	17CRP4	Direct
15JP4	15JP4	Direct	17CSP4	17BWP4	D
16ANP4	16ANP4	Direct	17CTP4	17CTP4	Direct
16AQP4	16ANP4	Direct	17CWP4	17DSP4	Direct
16ASP4	16ASP4	Direct	17CXP4	17CRP4	Direct
16ATP4	16BSP4	Direct	17CZP4	17BJP4	Direct
16AUP4	16AUP4	Direct	17DAP4	17DRP4	Direct
16AVP4	16BCP4	Direct	17DHP4	17DXP4	Direct
16AXP4	16ASP4	Direct	17DKP4	17DKP4	Direct
16AYP4	16AYP4	Direct	17DLP4	17DKP4	Direct
16BAP4	16BAP4	Direct	17DQP4	17DQP4	Direct
16BCP4	16BCP4	Direct	17DRP4	17DRP4	Direct
16BGP4	16CEP4	Direct	17DSP4	17DSP4	Direct
16BRP4	16BRP4	Direct	17DTP4	17DKP4	Direct
16BSP4	16BSP4	Direct	17DXP4	17DXP4	Direct
16BVP4	16BVP4	Direct	17DZP4	17DXP4	Direct
16BXP4	16BXP4	Direct	17EAP4	17HP4C	F
16CAP4	16CEP4	Direct	17EBP4	17DXP4	D
16CEP4	16CEP4	Direct	17EFP4	17DXP4	Direct
16CHP4	16BSP4	Direct	17EHP4	17EHP4	Direct
16CHP4A	16BSP4	Direct	17ELP4	17ELP4	Direct
16CJP4	16CJP4	Direct	17EMP4	17EMP4	Direct
16CMP4	16CMP4	Direct	17EQP4	17EQP4	Direct
16KP4	16RP4B	A	17FP4	17HP4C	A
16KP4A	16RP4B	A	17FP4A	17HP4C	A
16QP4	16RP4B	A, D	17HP4	17HP4C	A
16RP4	16RP4B	A	17HP4A	17HP4C	A
16RP4A	16RP4B	A	17HP4B	17HP4C	A
16RP4B	16RP4B	Direct	SG17HP4B	17HP4C	Direct
16TP4	16RP4B	A	17HP4C	17HP4C	Direct
16UP4	16RP4B	A, D	17JP4	17BP4B	Direct
16XP4	16RP4B	A, D	17KP4	17HP4C	A, F
17AP4	17BP4B	Direct	17KP4A	17HP4C	A, F
17ATP4	17BJP4	A	17LP4	17LP4B	Direct
17ATP4A	17BJP4	A	17LP4A	17LP4B	A
17AVP4	17BJP4	A	SG17LP4A	17LP4B	A
17AVP4A	17BJP4	A	17LP4B	17LP4B	Direct
17BP4	17BP4B	D	17QP4	17QP4B	A
17BP4A	17BP4B	Direct	17QP4A	17QP4B	A
17BP4B	17BP4B	Direct	SG17QP4A	17QP4B	A
17BP4C	17BP4B	Direct	17QP4B	17QP4B	Direct
17BJP4	17BJP4	Direct	17RP4	17HP4C	Direct
SG17BJP4	17BJP4	Direct	17RP4C	17HP4C	Direct
17BRP4	17DSP4	A	17SP4	17LP4B	A, F
17BWP4	17BWP4	Direct	17UP4	17QP4B	Direct
17BUP4	17BJP4	A	17VP4	17LP4B	Direct
17BVP4	17BWP4	A	17VP4B	17LP4B	Direct
17BZP4	17DSP4	Direct	17YP4	17QP4B	Direct
17CAP4	17DSP4	Direct	470ACB4	19AYP4	Direct
17CBP4	17BJP4	A	19ABP4	19ABP4	Direct

Type	SYLVANIA* Replacement	Replacement Classification
19ACP4	19CHP4	Direct
19AFP4	19AFP4	Direct
AR19AFP4	19AFP4	Direct
19AGP4	19AVP4	Direct
19AHP4	19AHP4	Direct
19AJP4	19AJP4	Direct
19ANP4	19AYP4	Direct
19ARP4	19AFP4	Direct
19AUP4	19AFP4	Direct
19AVP4	19AVP4	Direct
19AXP4	19AYP4	Direct
19AYP4	19AYP4	Direct
19BAP4	19BAP4	Direct
19BDP4	19BDP4	Direct
19BFP4	19BFP4	Direct
19BHP4	19BTP4	Direct
19BLP4	19AVP4	Direct
19BMP4	19AFP4	Direct
19BRP4	19DKP4	Direct
19BQP4	19BQP4	Direct
19BTP4	19BTP4	Direct
19BVP4	19AVP4	Direct
19BWP4	19AYP4	Direct
19CDP4	19CDP4	Direct
19CFP4	19CHP4	Direct
19CHP4	19CHP4	Direct
19CJP4	19AVP4	Direct
19CKP4	19CHP4	Direct
19CLP4	19CRP4	Direct
19CMP4	19CMP4	Direct
19CQP4	19CDP4	Direct
19CRP4	19CRP4	Direct
19CUP4	19CUP4	Direct
19CVP4	19CVP4	Direct
19CWV4	19BAP4	Direct
19CXV4	19CXV4	Direct
19CYP4	19BTP4	Direct
19CZP4	19CZP4	Direct
19DAP4	19DAP4	Direct
19DBP4	19DBP4	Direct
19DCP4	19EDP4	Direct
19DEP4	19AVP4	Direct
19DFP4	19DFP4	Direct
19DHP4	19FFP4	Direct
19DKP4	19DKP4	Direct
19DLP4	19CHP4	Direct
19DNP4	19DKP4	Direct
19DQP4	19DWP4	Direct
19DRP4	19EDP4	Direct
19DSP4	19FFP4	Direct
19DUP4	19DUP4	Direct
19DWP4	19DWP4	Direct
19DYP4	19CVP4	Direct
19DZP4	19DVP4	Direct
19EAP4	19ENP4	Direct

Type	SYLVANIA* Replacement	Replacement Classification
19EBP4	19EBP4	Direct
19ECP4	19FTP4	Direct
19EDP4	19EDP4	Direct
19EFP4	19EFP4	Direct
19EGP4	19EGP4	Direct
19EHP4	19EDP4	Direct
19EHP4A	19EDP4	Direct
19EJP4	19FEP4A	Direct
19EKP4	19EKP4	Direct
19ELP4	19AVP4	Direct
19EMP4	19FGP4	Direct
19ENP4	19ENP4	Direct
19ENP4A	19ENP4	Direct
19ERP4	19EDP4	Direct
19ESP4	19FFP4	Direct
19EUP4	19EDP4	Direct
19EVP4	19FDP4	Direct
19EWP4	19FDP4	Direct
19EZP4	19EZP4	Direct
19FBP4	19EGP4	Direct
19FCP4	19DWP4	Direct
19FDP4	19FDP4	Direct
19FEP4A	19FEP4A	Direct
19FEP4B	19FEP4A	Direct
19FGP4	19FGP4	Direct
19FHP4	19FHP4	Direct
19FJP4	19FJP4	Direct
19FLP4	19FTP4	Direct
19FSP4	19ENP4	Direct
19FTP4	19FTP4	Direct
19GAP4	19GAP4	Direct
19GFP4	19GFP4	Direct
19GJP4	19GJP4	Direct
19GMP4	19GMP4	Direct
19GTP4	19GTP4	Direct
19XP4	19AVP4	Direct
19YP4	19BTP4	Direct
19ZP4	19AVP4	Direct
20ADP4	20ADP4	Direct
20CP4	20DP4D	A, D
20CP4A	20DP4D	A
20CP4B	20DP4D	A, D
20CP4C	20DP4D	A, D
20CP4D	20DP4D	A
20DP4	20DP4D	A, D
20DP4A	20DP4D	A
20DP4B	20DP4D	A, D
20DP4C	20DP4D	A
20DP4D	20DP4D	Direct
SG20DP4D	20DP4D	Direct
20HP4	20HP4D	D
20HP4A	20HP4D	Direct
20HP4B	20HP4D	D
20HP4C	20HP4D	D
20HP4D	20HP4D	Direct

## TV PICTURE TUBE REPLACEMENT GUIDES (cont'd)

Type	SYLVANIA* Replacement	Replacement Classification	Type	SYLVANIA* Replacement	Replacement Classification
20LP4	20HP4D	Direct	21CUP4	21AMP4B	Direct
20MP4	20HP4D	Direct	21CVP4	21CBP4A	Direct
20RP4	20RP4	Direct	21CWP4	21CBP4A	A
20SP4	20YP4	Direct	21CX4	21DSP4	Direct
20TP4	20XP4	Direct	21CZP4	21DMP4	A
20UP4	20UP4	Direct	21DAP4	21DMP4	Direct
20WP4	20WP4	Direct	21DEP4	21DMP4	Direct
20XP4	20XP4	Direct	21DEP4A	21DMP4	Direct
500KB4	20XP4	Direct	SG21DEP4A	21DMP4	Direct
20YP4	20YP4	Direct	21DFP4	21EMP4	Direct
20ZP4	20ZP4	Direct	21DHP4	21DHP4	Direct
21ACP4	21AMP4B	A	21DLP4	21DLP4	Direct
21ACP4A	21AMP4B	A	21DMP4	21DMP4	Direct
SG21ACP4A	21AMP4B	A	21DNP4	21CBP4A	A
21AFP4	21YP4A	D	21DQP4	21DLP4	Direct
21ALP4	21CBP4A	A	21DSP4	21DSP4	Direct
21ALP4A	21CBP4A	A	21EAP4	21FDP4	C
21ALP4B	21CBP4A	A	21EP4	21EP4C	A, D
21AMP4	21AMP4B	A	21EP4A	21EP4C	A
21AMP4A	21AMP4B	A	21EP4B	21EP4C	A
21AMP4B	21AMP4B	Direct	SG21EP4B	21EP4C	Direct
21ANP4	21CBP4A	A, D	21EP4C	21EP4C	Direct
21ANP4A	21CBP4A	A, D	21EMP4	21EMP4	Direct
21AQP4	21AMP4B	A, D	21EQP4	21EQP4	Direct
21AQP4A	21AMP4B	A, D	21ESP4	21EMP4	Direct
21ASP4	21XP4B	A	21EVP4	21FDP4	C
21ATP4	21CBP4A	A	21FP4	21FP4D	A, D
21ATP4A	21CBP4A	A	21FP4A	21FP4D	A
21ATP4B	21CBP4A	A	21FP4C	21FP4D	A
21AUP4	21AUP4C	A	SG21FP4C	21FP4D	Direct
21AUP4A	21AUP4C	A	21FP4D	21FP4D	Direct
21AUP4B	21AUP4C	A	21FAP4	21FAP4	Direct
SG21AUP4B	21AUP4C	Direct	21FDP4	21FDP4	Direct
21AUP4C	21AUP4C	Direct	21FLP4	21CBP4A	Direct
21AVP4	21AUP4C	A	21FUP4	21FUP4	Direct
21AVP4A	21AUP4C	A	21FVP4	21FWP4	Direct
21AVP4B	21AUP4C	A	21FWP4	21FWP4	Direct
21AVP4C	21AUP4C	Direct	21FXP4	21FXP4	Direct
21AWP4	21AWP4A	A	21FYP4	21FYP4	Direct
21AWP4A	21AWP4A	Direct	21FZP4	21FZP4	Direct
SG21AWP4A	21AWP4A	Direct	21GCP4	21GCP4	Direct
21AYP4	21XP4B	A	21GTP4	21GTP4	Direct
21BAP4	21CBP4A	Direct	21WP4	21WP4B	A
21BCP4	21YP4B	Direct	21WP4A	21WP4B	A
21BDP4	21AUP4C	Direct	SG21WP4A	21WP4B	Direct
21BNP4	21CBP4A	Direct	21WP4B	21WP4B	Direct
21BSP4	21AMP4B	A	21XP4	21XP4B	A
21BTP4	21CBP4A	A	21XP4A	21XP4B	A
21CBP4	21CBP4A	Direct	SG21XP4A	21XP4B	Direct
21CBP4A	21CBP4A	Direct	21XP4B	21XP4B	Direct
21CBP4B	21CBP4A	Direct	21YP4	21YP4B	Direct
21CEP4	21EMP4	Direct	21YP4A	21YP4B	Direct
21CEP4A	21EMP4	Direct	21YP4B	21YP4B	Direct
21CMP4	21CBP4A	A	21ZP4	21ZP4C	A, D
21CQP4	21CQP4	Direct	21ZP4A	21ZP4C	A



Type	SYLVANIA* Replacement	Replacement Classification	Type	SYLVANIA* Replacement	Replacement Classification
21ZP4B	21ZP4C	A	23ESP4	23GBP4	Direct
SG21ZP4B	21ZP4C	Direct	23ETP4	23GTP4	Direct
21ZP4C	21ZP4C	Direct	23EWP4	23EWP4A	Direct
22AFP4	22AFP4	Direct	23EWP4A	23EWP4A	Direct
22ZP4	22ZP4	Direct	23EYP4	23EYP4	Direct
23ACP4	23BTP4	Direct	23EZP4	23EZP4	Direct
23AFP4	23BTP4	Direct	23EP4	23EP4	Direct
23ANP4	23BKP4	Direct	23FAP4	23FAP4	Direct
AR23ANP4	23BKP4	Direct	23FBP4	23FEP4	Direct
23AHP4	23AHP4	Direct	23FCP4	23FHP4	Direct
23ALP4	23ALP4	Direct	23FDP4	23FHP4	Direct
23ARP4	23ARP4	Direct	23FEP4	23FEP4	Direct
23ASP4	23ASP4	Direct	23FHP4	23FHP4	Direct
23ATP4	23BKP4	Direct	23FJP4	23GTP4	Direct
23AUP4	23AHP4	Direct	23FKP4	23FKP4	Direct
23AVP4	23CP4A	Direct	23FLP4	23FLP4	Direct
23AWP4	23BJP4	Direct	23FMP4	23GBP4	Direct
23BP4	23BP4	Direct	23FNP4	23FNP4	Direct
23BAP4	23BP4	Direct	23FP4	23FP4A	Direct
23BDP4	23BTP4	Direct	23FP4A	23FP4A	Direct
23BGP4	23BGP4	Direct	23FRP4	23FRP4	Direct
23BHP4	23BGP4	Direct	23FSP4	23FSP4	Direct
23BJP4	23BJP4	Direct	23FVP4	23HFP4	Direct
23BKP4	23BKP4	Direct	23FWP4	23FWP4	Direct
23BLP4	23BKP4	Direct	23FXP4	23FXP4	Direct
23BMP4	23BTP4	Direct	23GP4	23CP4A	Direct
23BNP4	23CP4A	Direct	23GBP4	23GBP4	Direct
23BQP4	23BQP4	Direct	23GEP4	23FEP4	Direct
23BTP4	23BTP4	Direct	23GFP4	23GFP4	Direct
23BVP4	23BTP4	Direct	23GJP4	23GJP4	Direct
23BWP4	23BTP4	Direct	23GJP4A	23GJP4	Direct
23CP4	23CP4A	Direct	23GSP4	23HLP4	Direct
23CP4A	23CP4A	Direct	23GTP4	23GTP4	Direct
AR23CP4	23CP4A	Direct	23GWP4	23GWP4	Direct
23CBP4	23BQP4	Direct	23GXP4	23HLP4	Direct
23CGP4	23CGP4	Direct	23HP4	23CP4A	Direct
23CQP4	23ALP4	Direct	23HCP4	23HCP4	Direct
23CZP4	23AHP4	Direct	23HFP4	23HFP4	Direct
23DKP4	23DKP4	Direct	23HFP4A	23HFP4	Direct
23DLP4	23DLP4A	Direct	23HGP4	23HQP4	Direct
23DLP4A	23DLP4A	Direct	23HLP4	23HLP4	Direct
23DNP4	23DNP4	Direct	23HQP4	23HQP4	Direct
23DQP4	23DQP4	Direct	23HRP4	23HWP4	Direct
23DSP4A	23DSP4A	Direct	23HSP4	23HWP4	Direct
23DTP4	23DKP4	Direct	23HUP4	23HUP4	Direct
23DVP4A	23GTP4	Direct	23HUP4A	23HUP4	Direct
23DYP4	23GTP4	Direct	23HWP4	23HWP4	Direct
23DZP4	23EWP4A	Direct	23HWP4A	23HWP4	Direct
23ECP4	23ECP4	Direct	23HXP4	23GBP4	Direct
23EDP4	23EDP4	Direct	23JP4	23JP4	Direct
23EKP4	23FLP4	Direct	23JEP4	23JEP4	Direct
23ELP4	23DKP4	Direct	23KP4	23FP4A	Direct
23EMP4	23DKP4	Direct	23KP4A	23FP4A	Direct
23ENP4	23FEP4	Direct	23MP4	23FP4A	Direct
23EQP4	23EWP4A	Direct	23MP4A	23FP4A	Direct

## TV PICTURE TUBE REPLACEMENT GUIDES (cont'd)

Type	SYLVANIA* Replacement	Replacement Classification	Type	SYLVANIA* Replacement	Replacement Classification
23NP4	23NP4	Direct	24VP4	24CP4B	A
23TP4	23BTP4	Direct	24VP4A	24CP4B	A
23UP4	23BQP4	Direct	24XP4	24CP4B	A, D
23WP4	23FP4A	Direct	24YP4	24AEP4	A
23XP4	23BTP4	Direct	24ZP4	24AEP4	Direct
23YP4	23BTP4	Direct	27ABP4	27ADP4	Direct
23ZP4	23ZP4	Direct	27ACP4	27YP4	Direct
24ADP4	24CP4B	A	27ADP4	27ADP4	Direct
24AEP4	24AEP4	Direct	27AGP4	27ADP4	Direct
24AHP4	24AHP4	Direct	27EP4	27RP4	D
24AJP4	24AJP4	Direct	27GP4	27RP4	D
24ALP4	24AHP4	Direct	27LP4	27LP4	Direct
24ANP4	24AEP4	A	27NP4	27RP4	Direct
24ATP4	24AJP4	Direct	27RP4	27RP4	Direct
24AUP4	24AUP4	Direct	27XP4	27XP4	Direct
24AVP4	24BEP4	E	27YP4	27YP4	Direct
24BEP4	24BEP4	Direct	27ZP4	27ZP4	Direct
24CP4	24CP4B	A			
24CP4A	24CP4B	A			
SG24CP4A	24CP4B	Direct			
24CP4B	24CP4B	Direct			
24DP4	24AEP4	A			
24DP4A	24AEP4	A			
24QP4	24CP4B	A, D			
24TP4	24CP4B	A			

## REPLACEMENT CLASSIFICATION NOTES

\* Replacement types available in "SRE" Color Bright 85; "RE" Color Bright 85 and Color Screen 85 lines.

## Other Footnotes

- ◆ Replacement information is based primarily on electrical and mechanical similarity of the picture tube types covered. The technician should make certain that replacement is in accord with all safety precautions required by the TV receiver for picture tube insulation or mechanical mounting. For all applications, the external conductive coating must be grounded and care must be taken that the coating does not contact any support straps or brackets which might result in voltage appearing on trim or external hardware of the receiver.
- A Replacement type does not require an external ion trap magnet.
- B Requires slight modification in tube mounting. See article "Color Fidelity for Older Color Receivers" published in Summer-Fall 1965 issue of *Sylvania News*.
- C The 21EAP4 has a 2.35 volt/600 milliampere heater, and type 21EVP4 employs a 2.68 v, 450 ma heater. The 21FDP4 has a 6.3 volt/600 milliampere heater. Instructions for

necessary minor set modification are packaged with each replacement type 21FDP4.

- D The high voltage filter condenser if any, must be removed from receiver since it is replaced by the capacitance of the tube.
- E Type 24AVP4 has a 2.35 volt/600 ma heater. Type 24BEP4 has a 6.3 volt/600 ma heater. Instructions for minor set modifications are packaged with each 24BEP4.
- F Connect pin No. 6 (G4) to pin No. 11 (K) at socket. Original type did not provide for focus control.
- G The tube type shown is considered a direct replacement. In some cases, however, it may be necessary to reverse the red and green cathode leads at socket to achieve proper white balance.
- H For some receivers, it may be necessary to modify the yoke mounting fixture to allow proper location of other neck components. In a few extreme cases, substitutions may not be feasible.
- I Mounting hardware may have to be modified to accept substitution. For some small cabinet receivers, substitutions may not be feasible.

## INSTALLATION AND HANDLING OF TELEVISION PICTURE TUBES AND LARGE CATHODE RAY TUBES

The installation and handling of television picture tubes and other large cathode ray tubes must be undertaken with considerable care. Picture tubes are large structures made up very largely of glass and enclosing an evacuated space. They should be handled carefully and protected from severe shock. The normal precautions used when working with any high voltage circuits should be observed. The proper procedures and precautions are presented below.

### Mechanical Handling

1. Protective face shield or goggles and gloves should be worn, for personal safety, whenever handling large picture tubes.
2. Picture tubes should be removed from the shipping carton face up and supported by the sides of the large portion of the tube. Handling of large picture tubes by the neck is unsafe and should be avoided at all times. It is obviously the weakest part of the tube and most easily injured. Therefore, the neck should always be kept free of strain and protected from striking other objects.
3. Picture tubes should be inserted into sockets by supporting the tube at the large end and holding the neck only for guiding the base pins into the socket.
4. The tubes should be removed from their sockets in the same manner as they are inserted, supported at the large end.
5. When not installed in a television receiver or other equipment, picture tubes should be stored in shipping cartons with the covers closed.
6. Avoid placing picture tubes on a table or bench where there is any possibility of the tube rolling off. This is very important.
7. Scratching the surface of a picture tube weakens the glass and may be the cause of the tube imploding. If it is necessary to place a tube elsewhere than in its shipping carton, a piece of felt or other soft material should be placed under it.
8. Picture tubes should be used for display purposes only after the vacuum seal has been broken. Economy dictates that only wornout, or otherwise worthless, tubes be used for this purpose. The vacuum seal may be broken in the following manner.
  - A. Place the tube in a shipping carton, face down, with enough soft packing material underneath so that the base will extend above the closed cover.
  - B. Break off locating lug on based types.
  - C. Using a small file or cutting pliers, make a small hole at the tip of the exhaust tube. Care should be used to make a small hole in the tip so that air will enter the tube slowly and not disturb the screen coating. In tubes using a metal exhaust tube a small three-cornered file may be used to make a small hole. The bright getter deposit on the neck should change color almost immediately. As a precaution, some time after the small hole has been made, it is well to break off the tip completely. The tube cannot implode after the vacuum seal has been broken, but it should still be handled as carefully as any other glassware of equal weight.
9. Discretion should be exercised in the disposal of tubes which are no longer useful to avoid possible legal liability. A safe method of breaking up a tube for disposal is to place it in a carton, seal the carton, and drive a metal rod through the carton into the face of the side of the tube. The broken parts may then be disposed of in the usual manner.
10. If a tube does break causing small cuts in the skin, such cuts should be washed carefully to be certain that all dirt and other small particles are removed. While the materials used for coating Sylvania picture tubes are not

## INSTALLATION AND HANDLING (cont'd)

considered to be toxic, there is the possibility of an unusual personal sensitivity or allergy in some persons.

### Handling High Voltage Circuits

1. Stand on dry wood, a rubber mat, linoleum or other dry insulating material when working on any electrical circuit.

2. One hand should be kept in a pocket to reduce the effects of accidental shock.

3. Respect all safety interlock switches and be certain that they are in good working condition.

4. Be certain that high voltage condensers are discharged before working on the circuit. Bleeder resistors may be open.

5. Some picture tubes have a conductive coating on both the inside and outside surfaces to form a condenser. This condenser should be discharged before the tube is handled. Even a slight unexpected shock might cause a tube to be dropped.

6. In circuits where the picture tube operates with a voltage on its second anode higher than 16,000 volts, it is possible that low intensity X-rays may be emitted. Therefore, X-ray radiation shielding may be necessary to protect against possible danger of personal injury from prolonged exposure at close range if the tube is operated at such high voltages.

7. Take the time to be safe.

# ECG REPLACEMENT SEMICONDUCTORS

	Page
Introduction .....	548
Replacement Considerations .....	548
<b>Technical Data</b>	
<b>Transistors</b> .....	549
<b>Field Effect Types</b> .....	551
<b>Diodes and Rectifiers</b> .....	551
<b>Zener Types</b> .....	552
<b>Outline Drawings</b> .....	553
ECG303 Solid State Repair Kit .....	554
Linear Integrated Circuits .....	555
<b>Replacement Guides</b>	
<b>Transistors</b> .....	558
<b>Diodes and Rectifiers</b> .....	599
<b>Quartz Color Oscillator Crystals</b> .....	622
<b>Canadian Receivers</b> .....	623

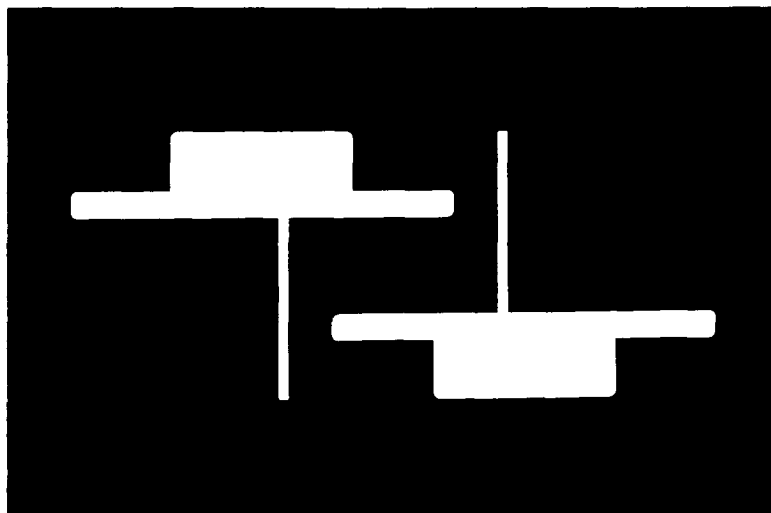

# ECG Replacement Semiconductors

## INTRODUCTION

To alleviate the mushrooming proliferation of solid-state devices faced more all the time by service technicians, Sylvania has evolved a high-quality line of replacement transistors, diodes, and integrated circuits. The ECG line of semiconductors is designed to minimize replacement parts inventory for the technician and yet economically meet replacement needs of the wide variety of entertainment equipment which he encounters. Selective additions are made to the line from time to time to keep abreast of the many new types as they find their way into the field. This section provides replacement considerations, complete specifications and outline drawings of these ECG products, as well as a replacement guide which cross references approximately 28,000 JEDEC types and manufacturers' part numbers, including types by Canadian set manufacturers, to the 64 Sylvania ECG types which replace them.

Also available through Sylvania Electronic Tube Distributors is the **ECG212 Semiconductors Replacement Guide/Catalog**, from which this section is excerpted. This replacement guide is the **most comprehensive in the industry and is periodically revised** as the need arises.

The ECG line additionally includes a solid state repair kit, the ECG303, containing the most recent replacement guide and 24 of the most commonly used semiconductors from the line—packaged small enough to fit into a tube caddy and replacing over 20,000 types.

## REPLACEMENT CONSIDERATIONS

The technical data given on the following pages are intended to show safe areas of ECG device oper-

ation and level of performance. They are not to be considered limits for new equipment designs. Sylvania Electric Products Inc. cannot guarantee that the listed items provide an exact replacement in all applications.

When replacing the original part with an ECG unit, certain mechanical and electrical requirements must be observed. Compare the lead or terminal arrangement of the original part with the ECG replacement. If necessary, bend the leads to the proper basing arrangement and insulate them to prevent possible shorts. For socketed devices, cut the leads on the replacement to proper length. Check the outline dimensions of the replacement if mounting space is a problem. Replacement in untuned stages can generally be made with a minimum of effort. In the case of tuned amplifiers, oscillators, etc., a check of the stage alignment may be in order to assure optimum performance. UHF, VHF and FM circuits are especially critical.

Replacement in high power audio stages should always be accompanied by a check on the transistor bias to prevent excessive dissipation and/or distortion. The equipment manufacturers recommended procedure should be followed.

When making replacements that require soldering of the ECG device leads, always use a small, hot iron and rosin core solder. If possible, a suitable heat sink, such as a pair of needle-nose pliers, should be positioned on the lead between the device and the solder joint. Do the soldering quickly.

In the case of power devices requiring the use of an insulating washer, apply silicone grease to both sides of the washer to insure maximum thermal efficiency.

MAXIMUM RATINGS AT 25° C AMBIENT UNLESS OTHERWISE NOTED

Type	Description	Applications	Collector-Base Voltage (BV <sub>CB0</sub> )	Collector-Emitter Voltage (BV <sub>CE0</sub> )	Base-Emitter Voltage (BV <sub>EB0</sub> )	Max. Collector Current	Max. Collector Dissipation	Frequency	Typical Current Gain (HFE)	Package
ECG 100	PNP-Germanium	RF Amp, Osc, Mixer, IF Amp of AM Radios	25V	20V (CER) Min.	20V	300 mA	150 mW	5 MHz <sup>(1)</sup>	40 (at 455 kHz)	TO-5 Fig. 1
ECG101	NPN-Germanium	RF Amp, Osc, Mixer, IF Amp of AM Radios	25V	20V (CER) Min.	20V	300 mA	150 mW	5 MHz <sup>(1)</sup>	40 (at 455 kHz)	TO-5 Fig. 1
ECG102	PNP-Germanium	Audio Driver, Pre-Amp, Power Output	30V	16V (CER) Min.	20V	250 mA	150 mW	2 MHz <sup>(1)</sup>	90 (at 1 kHz)	TO-5 Fig. 1
ECG102A	PNP-Germanium	Audio Driver, Pre-Amp, Power Output	32V	32V (CES)	10V	200 mA	900 mW	2.3 MHz	120	TO-1 Fig. 2
ECG103	NPN-Germanium	Audio Driver, Pre-Amp, Power Output	30V	16V (CER) Min.	20V	250 mA	150 mW	2 MHz <sup>(1)</sup>	90 (at 1 kHz)	TO-5 Fig. 1
ECG103A	NPN-Germanium	Audio Driver, Pre-Amp, Power Output	32V	32V (CES)	10V	500 mA	340 mW	2.5 MHz	105	TO-1 Fig. 2
ECG104 ECG104MP	PNP-Germanium Matched Pair of ECG104	Audio Power Output	50V	35V (CER) Min.	20V	7 A	90 W	10 KHz <sup>(1)</sup>	90	TO-3 Fig. 3
ECG105	PNP-Germanium	Audio Power Output	50V	35V (CER) Min.	20V	15 A	100 W	10 KHz <sup>(1)</sup>	90	TO-36 Fig. 4
ECG106	PNP-Silicon	RF Amp, Osc, Mixer, IF Amp, All Band and FM Radios	35V	15V Min.	1V	75 mA	250 mW	500 MHz <sup>(2)</sup>	20 Min.	TO-18 Fig. 5
ECG107	NPN-Silicon	RF Amp, Osc, Mixer, IF Amp in UHF, VHF	35V	15V Min.	1V	25 mA	250 mW	700 MHz <sup>(2)</sup>	20 Min	TO-32 Fig. 6

## TRANSISTORS (cont'd)

MAXIMUM RATINGS AT 25° C AMBIENT UNLESS OTHERWISE NOTED

Type	Description	Applications	Collector-Base Voltage (BV <sub>CB0</sub> )	Collector-Emitter Voltage (BV <sub>CE0</sub> )	Base-Emitter Voltage (BV <sub>EB0</sub> )	Max. Collector Current	Max. Collector Dissipation	Frequency	Typical Current Gain (HFE)	Package
ECG108	NPN-Silicon	RF Amp, Osc, Mixer, IF Amp in VHF, UHF, Video Amp	35V	15V Min	0.5V	75 mA	250 mW	800 MHz <sup>(2)</sup>	10 Min	RO-97A Fig. 7
ECG121 ECG121MP	PNP-Germanium Matched Pair of ECG121	Audio Power Output for Stereo and Hi-Fi, etc.	65V	45V (CER) Min	15V	7 A	90 W	22 KHz <sup>(1)</sup>	80	TO-3 Fig. 3
ECG123	NPN-Silicon	Audio Pre-Amp, Driver, Video Amp, Sync Separator	30V	20V	5V	500 mA	500 mW	50 MHz <sup>(2)</sup>	180	TO-5 <sup>(3)</sup> Fig. 8
ECG123A	NPN-Silicon	Audio Amp, RF Amp	55V	40V	6V	600 mA	500 mW	200 MHz	200	TO-18 <sup>(3)</sup> Fig. 5
ECG124	NPN-Silicon	High Voltage Audio Power Output for 120 VAC TV, Phono, Stereo, etc.	300V	300V	5.0V	400 mA	10 W	30 MHz <sup>(2)</sup>	140	TO-66 Fig. 9
ECG126	PNP-Germanium	RF Amp, Osc, Mixer, IF Amp for All Band Radios and VHF	25V	25V	2V	200 mA	200 mW	250 MHz <sup>(2)</sup>	60	TO-24 Fig. 10
ECG127	PNP-Germanium	Horiz. and Vert. Deflection Amps, Audio Power Output	350V	350V (CES)	2V	10A	56 W	1.0 MHz <sup>(2)</sup>	15 min	TO-3 Fig. 3
ECG128	NPN-Silicon	Audio Pre-Amp, Driver, Output, Video Amp.	100V	80V (CER)	7V	1 A	1 W	120 MHz <sup>(2)</sup>	90	TO-5 Fig. 1
ECG129	PNP-Silicon	Audio Pre-Amp, Driver, Output, Video Amp.	100V	80V (CER)	7V	1A	1 W	120 MHz <sup>(2)</sup>	90	TO-5 Fig. 1
ECG130 ECG130MP	NPN-Silicon Matched Pair of ECG130	Audio Power Amp.	80V	60V (CER)	5V	15 A	115 W	800 KHz <sup>(1)</sup>	40	TO-3 Fig. 3
ECG131 ECG131MP	PNP-Germanium Matched Pair of ECG131	Audio Pwr. Output for Auto Radio, Stereo Tape Players, etc.	32V	20V	10V	3 A Peak	6 W (65°C)	1 MHz	110	Similar TO-66 Fig. 9
ECG152	NPN-Silicon	Audio Power Output	60V	60V	5V	3 A	40 W	3 MHz <sup>(2)</sup>	60	“P-66” (Plastic) Fig. 12



ECG153	PNP-Silicon	Audio Power Output	60V	60V	5V	3 A	40 W	3 MHz <sup>(2)</sup>	60	"P-66" (Plastic) Fig. 12
ECG154	NPN-Silicon	Color/BW TV Video Output Amp.	300V	300V	7V	50 mA	1 W	40 MHz <sup>(3)</sup>	100	TO-39 Fig. 13
ECG155	NPN-Germanium	Audio Power Amp.	32V	20V	10V	3 A Peak	7.5 W	1 MHz	110	Similar to TO-66 Fig. 9
ECG157	NPN-Silicon	High Voltage Audio Power Amp.	300V	300V	3V	500 mA	20.8 W	10 MHz	30 min	Fig. 14

### FIELD EFFECT TRANSISTORS—N—Channel Junction Types

Type	Application	Transconductance ( $\mu$ Mhos)	Drain Source Voltage (VDS)	Current (mA DC)	Gate-Source Breakdown Voltage (V (BR) GSS)	Gate Reverse Current (IGSS)	Zero-Gate Voltage Drain-Current (IDSS)	Total Device Dissipation (mW)	Outline Drawing
ECG132	R.F. Amp and Mixer into VHF Region	2000 min at 100 MHz	25V	10 Ig	25V	2 nA DC	2-20 mA DC	200	Fig. 11
ECG133	General Purpose Audio Amp and Switch	4000 typ.	25V	10 Ig	25V	1 nA DC	0.5-15 mA DC	300	Fig. 11

**NOTES:**

- (1) Frequency at which Common Emitter Gain is 70.7% of Low Frequency Gain
- (2) Gain Bandwidth Product Minimum
- (3) Collector Tied to Case Maximum Ratings at 25°C Ambient Unless Otherwise Noted

## DIODES and RECTIFIERS

Type	Outline Drawing	Description
ECG109	Fig. 15	Germanium general purpose 75 volt P. R. V.
ECG110	Fig. 15	Germanium matched pair
ECG111	Fig. 16	Silicon UHF TV mixer diode

Type	Outline Drawing	Description
ECG112	Fig. 15	Silicon UHF TV mixer diode
ECG113	Fig. 17	Selenium dual diode, common cathode, TV horizontal AFC

# DIODES and RECTIFIERS (cont'd)

Type	Outline Drawing	Description
ECG114	Fig. 17	Selenium dual diode, series connected, TV horizontal AFC
ECG115	Fig. 17	Selenium dual diode, common anode, TV horizontal AFC
ECG116	Fig. 18	Silicon rectifier, 600 P.R.V., 1A (DC resistive)
ECG117	Fig. 19	Silicon rectifier 600 P.R.V., 1A (DC resistive) max
ECG118	Fig. 20	Selenium color TV focus rectifier, 6500 P.R.V.

Type	Outline Drawing	Description
ECG119	Fig. 21	Selenium color TV boost rectifier, 800 P.R.V., DC output current—2mA resistive
ECG120	Fig. 22	Selenium color TV convergence rectifier, 18 P.R.V., RMS volts 12, output current 65 mA
ECG125	Fig. 23	Silicon rectifier, 1000 volt P.R.V. 1.0 amp (d.c. resistive)
ECG156	Fig. 18	Silicon rectifier 1000 volt P.R.V. 2.0 amp

**ECG122**

Silicon Controlled Rectifier  
(Shipped Complete With All Mounting Hardware)

Continuous and Peak Forward and Reverse Blocking Voltage ..... 200 Volts  
 Continuous Anode Forward Current at or Below 70°C Case Temp. .... 7.0 Ampere  
 Average Anode Forward Current (180 Conduction Angle) at or Below 70°C Case Temp. .... 5.0 Ampere  
 Peak Anode Surge Current (60 Hz—1/2 Sinewave) ..... 100 Ampere  
 Gate Trigger Current (Max.) ..... 25 mA  
 Gate Trigger Voltage (Max.) ..... 4.0 Volt  
 Holding Current ..... 25 mA—Max

# ZENER DIODES (1 Watt = 10% Voltage Tolerance)

Type	Nom. Zener Voltage Vz at Izt	Test Current Izt (Ma)	Zener Impedance Zzt at Izt ( $\Omega$ )	D.C. Zener Current Izm (Ma)	Outline Drawing
ECG134	3.6V	69	11.0	252	Fig. 23
ECG135	5.0V	50	8.0	182	Fig. 23
ECG136	5.6V	45	6.0	162	Fig. 23
ECG137	6.2	41	3.0	146	Fig. 23
ECG138	7.5V	33	6.0	120	Fig. 23
ECG139	9.1V	28	6.0	95	Fig. 23
ECG140	10.0V	25	7.0	85	Fig. 23
ECG141	11.5V	22	9.0	78	Fig. 23
ECG142	12.0V	21	10.0	76	Fig. 23

Type	Nom. Zener Voltage Vz at Izt	Test Current Izt (Ma)	Zener Impedance Zzt at Izt ( $\Omega$ )	D.C. Zener Current Izm (Ma)	Outline Drawing
ECG143	12.8V	19	11.0	73	Fig. 23
ECG144	14.0V	18	13.0	65	Fig. 23
ECG145	15.0V	17	15.0	56	Fig. 23
ECG146	27.0V	9.5	36.0	30	Fig. 23
ECG147	33.0V	7.5	46.0	26	Fig. 23
ECG148	55.0V	4.5	110.0	16	Fig. 23
ECG149	62.0V	4.0	126.0	13	Fig. 23
ECG150	82.0V	3.0	200.0	10	Fig. 23
ECG151	110.0V	2.3	450.0	7.2	Fig. 23

# Dimensional Outlines

## TRANSISTORS

FIGURE 1

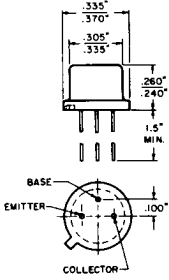

FIGURE 2

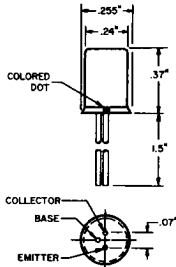

FIGURE 3

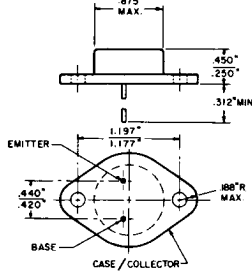

FIGURE 4

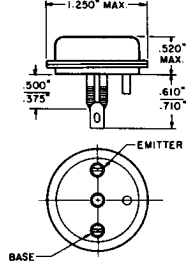

FIGURE 5

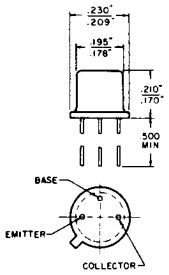

FIGURE 6

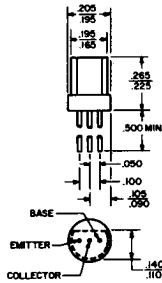

FIGURE 7

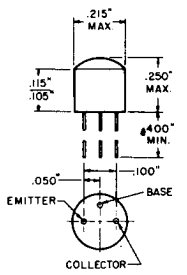

FIGURE 8

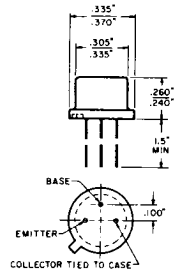

FIGURE 9

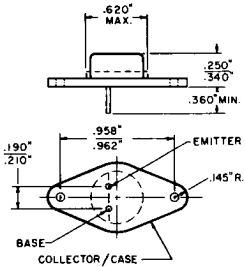

FIGURE 10

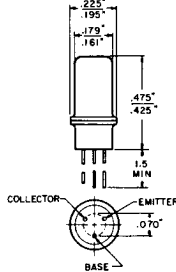

FIGURE 11

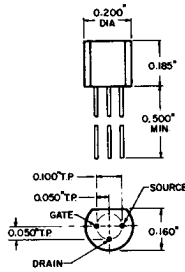

FIGURE 12

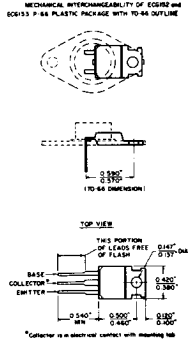

FIGURE 13

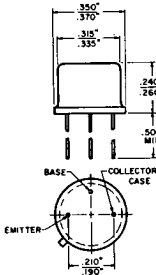
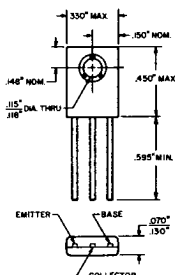

FIGURE 14



## DIODES and RECTIFIERS

FIGURE 15

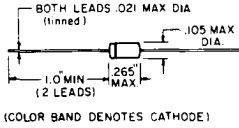

FIGURE 16

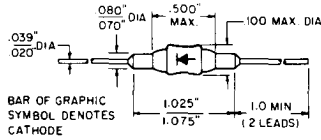

FIGURE 17

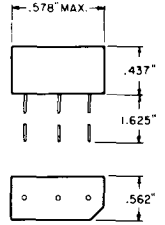

FIGURE 18

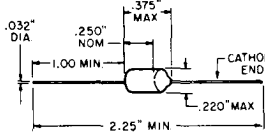

FIGURE 19

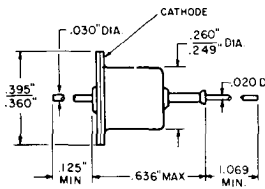

FIGURE 20

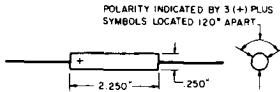

FIGURE 21

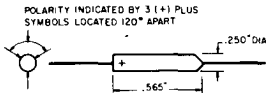

FIGURE 23

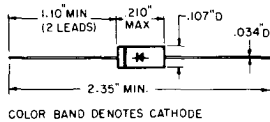
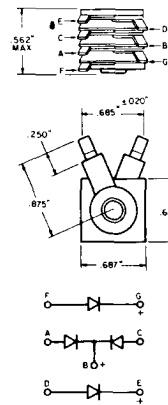

FIGURE 22



### ECG303 SOLID STATE REPAIR KIT

Contains 95% of Most Common Replacement Needs

Quantity	Type	Quantity	Type	Quantity	Type
1	ECG100	1	ECG110	1	ECG124
1	ECG101	1	ECG113	4	ECG125
1	ECG102	1	ECG114	1	ECG126
1	ECG103	4	ECG116	1	ECG128
1	ECG104	1	ECG118	1	ECG129
1	ECG105	1	ECG119	1	ECG130
1	ECG106	1	ECG121	1	ECG131
2	ECG109	1	ECG123	1	ECG358

24 ECG Devices Replace Over 20,000 Types.

# LINEAR INTEGRATED CIRCUITS

Type	Description
<p><b>ECG370</b> <b>AGC/Squelch</b> <b>Amplifier</b></p>	<p>Direct-coupled monolithic amplifier which utilizes an external DC voltage to control gain. In addition to communication system squelch and AGC applications, useful as a constant-amplitude audio oscillator, linear low frequency modulator, single-sideband automatic load control, and as a variable DC gain element in analog computation. 40 dB voltage gain to -80 dB gain reduction; operates on 4.5 to 24 VDC supply at low power dissipation. Provides differential inputs, with wide common-mode input range.</p>
<p><b>ECG371</b> <b>RF/IF Amplifier</b></p>	<p>Monolithic RF-IF amplifier capable of emitter-coupled or cascode operation from DC to 250 MHz. Other applications of the circuit are as mixer, oscillator, detector, and modulator. Typical input signal is 10 mV rms; operates on 3 to 24 VDC. 100 MHz tuned power gains are 24.6 dB (emitter coupled) and 27.5 dB (cascode).</p>
<p><b>ECG372</b> <b>AM IF Strip</b></p>	<p>Broadband AM receiver subsystem, including a high-gain amplifier, an active detector, and self-contained automatic gain control. It is intended for IF or TRF applications from 50 KHz to 2 MHz. AGC range is 60 dB; audio output is 0.8 V p-p for 80% modulated input at carrier level as low as 50 mV rms; operates on 6 to 24 VDC supply.</p>

## LINEAR INTEGRATED CIRCUITS (cont'd)

Type	Description
<p><b>ECG703</b>  <b>RF/IF Amplifier,  Oscillator, Mixer</b></p>	<p>Direct replacement for <math>\mu</math>A 703, <math>\mu</math>A 703E and 15-26-587 in FM IF amplifier stages. Limiting or nonlimiting amplifier, harmonic mixer, or oscillator useful to frequencies in excess of 100 MHz. Circuit applications include 10, 30, 100, and 200-MHz RF Amplifiers, 10.7-MHz FM IF amplifier, 10-MHz oscillator, color TV sound IF amplifier, and a 3.58-MHz injection-locked oscillator for color TV. Power gain is 41 dB unneutralized; transconductance is 30,000 <math>\mu</math>mhos; operates on 6-12 VDC supply.</p>
<p><b>ECG704</b>  <b>TV Sound—IF  Amplifier and  Detector</b></p>	<p>Direct replacement of TV sound IF stages. Circuit applications include IF amplifier, AM and noise limiter, FM detector, and audio preamplifier. Typical power gain at 4.5 MHz is 75 dB; AM rejection is over 50 dB at 4.5 MHz; operates on 5.5 to 10 VDC supply.</p>
<p><b>ECG705</b>  <b>Color TV Chroma  Demodulator</b></p>	<p>Direct plug-in replacement for the <math>\mu</math>A 737E; demodulates Chroma subcarrier information contained in color TV video signal and provides color difference signals at the outputs. Low voltage drift of the DC output insures excellent performance in direct-coupled, Chrominance output circuitry. Operates on 28 VDC; minimum load: 3K ohm; P-P reference input voltage: 5V; P-P Chrominance input: 5V; internal power dissipation: 450 mW.</p>
<p><b>ECG716</b>  <b>Audio Amplifier</b></p>	<p>Audio amplifier capable of delivering up to 250 mW of power to an 8-ohm speaker or headset. Voltage gain of X10, X20, X100, or X200 can be chosen by selection of the appropriate circuit terminals. Frequency response is 50 Hz to 500 kHz; operates on 18-25 VDC.</p>

## **ECG SEMICONDUCTOR REPLACEMENT GUIDES**

	<b>Page</b>
<b>Transistor Replacement Guide</b> .....	<b>558</b>
<b>Diodes and Rectifiers Replacement Guide</b> .....	<b>599</b>
<b>Color Oscillator Crystals Replacement Guide</b> .....	<b>622</b>
<b>For Canadian Receivers Replacement Guide</b> .....	<b>623</b>

# TRANSISTOR replacement guide

Type To Be Replaced	Sylvania ECG Replacement	Type To Be Replaced	Sylvania ECG Replacement	Type To Be Replaced	Sylvania ECG Replacement	Type To Be Replaced	Sylvania ECG Replacement	Type To Be Replaced	Sylvania ECG Replacement	Type To Be Replaced	Sylvania ECG Replacement
0000101	126	022-5511-790	126	080236	126	2G339A	103	2N34A	102	2N97A	101
0000102	126	022-3516-380	126	080244	126	2G344	126	2N35	103	2N98	101
0000103	102	022-3640-050	121	080245	126	2G345	100	2N36	102	2N98A	101
0000104	102	022-3640-080	108	080253	126	2G371	100	2N37	102	2N99	101
002-005100	102	025B	123	080266	126	2G371A	100	2N38	102	2N100	101
002-006300	126	025-100003	108	080267	126	2G374	100	2N38A	102	2N103	101
002-006500	123	025-100004	108	080269	126	2G374A	100	2N39	102	2N104	102
002-006600	102	025-100009	108	080274	100	2G376	126	2N40	102	2N105	102
002-006800	102	025-1000012	108	080275	100	2G377	126	2N41	102	2N106	102
002-006900	102	025-1000013	108	080276	100	2G381	102	2N42	102	2N107	102
002-007000	104	025-1000014	128	080277	126	2G381A	102	2N43	102	2N108	102
002-007100	126	025-100015	128	081001	102	2G382	162	2N43A	102	2N109	102
002-007200	126	026-100003	121	081018	102	2G383	100	2N44	102	2N109/5	126
002-007300	102	026-100005	102	081019	102	2G384	102	2N44A	102	2N109YEL	102
002-007400	126	026-100012	102	081038	102	2G385	102	2N45	102	2N109GRN	102
002-008100	104	026-100013	128	081046	102	2G386	102	2N45A	100	2N109BLU	102
002-008400	100	026-100017	123	081047	102	2G387	102	2N46	102	2N109WHT	102
002-008900	121	026-100018	102	081048	102	2G394	100	2N47	102	2N109M1	102
002-009100	124	026-100020	121MP	081049	102	2G395	100	2N48	102	2N109M2	102
002-009500	123	03-0020-0	102	081050	102	2G396	100	2N48A	102	2N111	100
002-009501	123	03-0022	102	081056	102	2G397	100	2N49	102	2N111A	100
002-009600	123	03-0023-0	102	084001	129	2G401	102	2N50	102	2N111B	126
002-009701	121	03-57-001	126	087003	102	2G402	102	2N51	102	2N111M1	126
002-009800	129	03-57-002	126	1G100	105	2G403	102	2N52	102	2N111M2	126
002-009900	123	03-57-101	126	2A	126	2G404	102	2N53	102	2N112	126
002-010100	121	03-57-201	126	2AC128	100	2G413	102	2N54	102	2N112A	100
002-010300	129	03-57-301	102	2AD140	121	2G414	102	2N55	102	2N112M1	126
002-010400	123	03-57-304	102	2B	100	2G415	102	2N56	102	2N113	100
002-010500	129	03-57-501	121	2C	100	2G416	102	2N59	102	2N114	100
002-010600	129	04-57-303	102	2D	100	2G417	102	2N59A	102	2N117	123
002-010700	128	0573036	102	2E	126	2G508	102	2N59B	102	2N118	123
002-010800	102	0573037	102	2F	126	2G509	102	2N59C	102	2N118A	123
002-010900	129	0573142	102	2G	126	2G524	100	2N59D	102	2N119	123
002-011400	108	0573166	104	2G101	100	2G525	100	2N60	102	2N120	123
002-011500	108	0573199	127	2G102	100	2G526	100	2N60A	102	2N123	100
002-011600	100	0573200	102	2G103	126	2G527	100	2N60B	102	2N123A	126
002-011700	103	0573212	127	2G104	126	2G577	100	2N60C	102	2N124	101
002-011800	102	0573366	126	2G106	126	2G601	126	2N60R	102	2N125	101
002-011900	102	0573398	126	2G108	100	2G602	126	2N61	102	2N126	101
002-012000	123	0573422	102	2G109	100	2G603	126	2N61A	102	2N127	101
002-012100	129	0573428	126	2G110	100	2G604	126	2N61B	102	2N128	126
002-012200	128	0573469	123	2G138	100	2G605	102	2N61C	102	2N129	126
002-012500	128	0573474	108	2G139	100	2G1024	100	2N62	102	2N130	102
002-012600	129	0573475	108	2G140	100	2G1025	100	2N63	102	2N130A	102
003-H03	102	0573480	123	2G201	100	2G1026	100	2N64	102	2N131	102
004-8000	121	0573481	123	2G202	100	2G1027	102	2N65	102	2N131A	102
007-0074	152	0573515	124	2G210	121	2H1254	106	2N71	102	2N132	102
011-H01	100	0573518	126	2G220	121	2H1255	106	2N72	126	2N132A	102
012-H02	100	0573532	128	2G221	121	2H1256	106	2N73	102	2N133	102
0130	128	080001	126	2G222	121	2H1257	106	2N74	102	2N133A	102
02P1B	128	080003	102	2G223	104	2H1258	106	2N75	126	2N135	100
019-003315	126	080004	102	2G224	121	2H1259	106	2N76	102	2N136	100
019-003317	103	080006	108	2G225	121	2J72	126	2N77	102	2N137	100
019-003318	103	080021	108	2G240	121	2J73	126	2M78	101	2N138	102
019-003319	103	080022	108	2G270	102	2K48	126	2N78A	101	2N138A	102
019-003324	100	080023	108	2G271	102	2MC	126	2N79	102	2N138B	102
019-003342	100	080026	126	2G301	102	2N2J324	128	2N80	102	2N139	100
019-003343	100	080027	126	2G302	102	2N23	102	2N81	102	2N140	100
019-003349	108	080028	126	2G303	102	2N24	102	2N82	102	2N140M1	100
019-003415	102	080041	108	2G304	102	2N25	102	2N83	100	2N140M2	100
019-003416	102	080042	108	2G306	102	2N26	102	2N85	126	2N145	101
019-003777	126	080043	108	2G308	102	2N27	100	2N86	126	2N146	101
019-003778	126	080059	108	2G309	126	2N28	101	2N87	126	2N147	101
0019-003485	152	080060	108	2G319	100	2N29	101	2N88	126	2N148	123
022-006500	123	080061	126	2G320	100	2N30	126	2N89	126	2N148A	123
022-3504-040	102	080071	126	2G321	102	2N31	126	2N90	126	2N149	123
022-3504-060	102	080072	126	2G322	102	2N32	102	2N94	102	2N149A	123
022-3505-910	102	080073	102	2G323	102	2N32A	102	2N94A	101	2N150	101
022-5311-770	126	080114	126	2G324	102	2N33	126	2N96	102	2N150A	101
022-5311-780	126	080206	126	2G339	103	2N34	102	2N97	101	2N151	102



TRANSISTORS (cont'd)

Type To Be Replaced	Sylvania ECG Replacement	Type To Be Replaced	Sylvania ECG Replacement	Type To Be Replaced	Sylvania ECG Replacement	Type To Be Replaced	Sylvania ECG Replacement	Type To Be Replaced	Sylvania ECG Replacement
2N155	121	2N206	102	2N267	100	2N329A	129	2N396	100
2N156	104	2N207	102	2N268	121	2N329B	129	2N396A	100
2N157	121	2N207A	102	2N268A	121	2N330	129	2N397	100
2N157A	121	2N207B	102	2N269	100	2N330A	129	2N398	102
2N158	121	2N207BLU	102	2N270	102	2N331	126	2N398B	102
2N158A	121	2N211	101	2N270A	102	2N332	123	2N399	104
2N159	102	2N212	101	2N270-5M	102	2N332A	123	2N400	104
2N160	123	2N213	103	2N271	100	2N333	123	2N401	104
2N160A	123	2N213A	103	2N271A	100	2N333A	123	2N402	102
2N161	123	2N214	103	2N272	102	2N334	123	2N403	102
2N161A	123	2N214A	103	2N273	100	2N334A	123	2N404	102
2N162	123	2N215	102	2N274	126	2N335	123	2N404A	102
2N162A	123	2N216	101	2N274BLU	126	2N335A	123	2N405	102
2N163	123	2N217	102	2N274WHT	126	2N335B	123	2N406	102
2N163A	123	2N217A	100	2N275	126	2N336	123	2N406BRN	100
2N164	101	2N217RED	100	2N276	126	2N336A	123	2N406RED	100
2N164A	101	2N217YEL	100	2N277	105	2N337	107	2N406GRN	100
2N165	101	2N217WHT	100	2N278	105	2N337A	108	2N406GRN	100
2N166	101	2N218	100	2N279	102	2N338	123	2N406BLU	100
2N167	101	2N219	100	2N280	102	2N338A	123	2N406GRN-YEL	100
2N167A	101	2N220	102	2N281	102	2N344	126	2N407	102
2N168	101	2N222	102	2N282	102	2N345	126	2N407BLK	102
2N168A	101	2N223	102	2N283	102	2N346	126	2N407RED	102
2N169	101	2N224	102	2N284	102	2N350	121	2N407YEL	102
2N169A	101	2N225	102	2N284A	102	2N350A	121	2N407GRN	102
2N170	101	2N226	102	2N2P5	104	2N351	121	2N407WHT	102
2N172	101	2N227	102	2N285A	104	2N351A	121	2N408	102
2N173	105	2N228	103	2N285B	104	2N352	121	2N408WHT	102
2N174	105	2N229	103	2N286	100	2N353	121	2N409	102
2N174A	105	2N230	104	2N290	104	2N356	101	2N410	100
2N175	102	2N231	126	2N291	102	2N356A	101	2N411	100
2N176	104	2N231YEL	100	2N292	101	2N357	101	2N412	100
2N176A	104	2N231YEL-RED	100	2N292A	101	2N357A	101	2N413	100
2N176G	104	2N231BLU	100	2N293	101	2N358	101	2N413A	100
2N176W	104	2N232	126	2N296	104	2N358A	101	2N414	100
2N176BLK	121	2N233	101	2N297	121	2N359	102	2N414A	100
2N176RED	121	2N233A	101	2N297A	121	2N360	102	2N414B	100
2N176GRN	121	2N234	121	2N299	126	2N361	102	2N414C	100
2N176BLU	121	2N234A	121	2N300	126	2N362	102	2N415	100
2N176 PUR	121	2N235	121	2N301	121	2N362B	102	2N415A	100
2N176WHT	121	2N235A	121	2N301A	121	2N363	102	2N416	100
2N176YEL	121	2N235B	121	2N301B	102	2N364	103	2N417	100
2N176-1	104	2N236	121	2N301G	102	2N365	103	2N418	121
2N176-1YEL	121	2N236A	121	2N301W	102	2N366	103	2N419	104
2N176-1BLU	121	2N236B	121	2N302	102	2N367	102	2N420	121
2N176-1WHT	121	2N237	102	2N303	102	2N368	102	2N420A	121
2N176-3PUR	121	2N238	102	2N306	103	2N369	102	2N422	102
2N176-4PUR	121	2N238D	102	2N306A	103	2N370	126	2N422A	102
2N176-5WHT	121	2N238E	102	2N307	121	2N370A	126	2N425	100
2N176-6WHT	121	2N238F	102	2N307A	121	2N370/33	126	2N426	100
2N178	104	2N238ORN	102	2N307B	121	2N371	126	2N427	100
2N179	104	2N240	126	2N308	100	2N371/33	126	2N428	100
2N180	102	2N241	102	2N309	100	2N372	126	2N428A	100
2N181	102	2N241A	102	2N310	102	2N372/33	126	2N431	123
2N182	101	2N242	104	2N311	100	2N373	126	2N432	123
2N183	101	2N247	126	2N312	101	2N374	126	2N433	123
2N184	101	2N247/33	126	2N313	101	2N375	104	2N438	101
2N185	102	2N248	126	2N314	101	2N376	104	2N438A	101
2N185-BLU	102	2N249	100	2N315	100	2N376A	104	2N439	101
2N186	102	2N250	104	2N315A	102	2N377	101	2N439A	101
2N186A	102	2N250A	104	2N315B	102	2N377A	101	2N440	101
2N187	102	2N251	104	2N316	100	2N378	104	2N440A	101
2N187A	102	2N251A	121	2N316A	102	2N379	121	2N441	105
2N188	102	2N252	100	2N317	100	2N380	100	2N441BLU	105
2N188A	102	2N253	101	2N317A	100	2N381	102	2N442	105
2N189	102	2N254	101	2N318	126	2N382	102	2N443	105
2N190	102	2N255	104	2N319	102	2N383	102	2N444	101
2N191	102	2N255A	104	2N320	102	2N384	126	2N444A	103
2N192	102	2N256	104	2N321	102	2N384/33	126	2N445	101
2N193	101	2N256A	104	2N322	102	2N385	101	2N445A	123
2N194	101	2N257	104	2N323	102	2N385A	101	2N446	101
2N194A	101	2N257A	104	2N324	102	2N386	104	2N446A	103
2N195	102	2N257B	104	2N325	104	2N387	104	2N447	101
2N196	102	2N257G	104	2N327	100	2N388	101	2N447A	103
2N197	102	2N257W	104	2N327A	100	2N388A	101	2N447B	103
2N198	102	2N262	100	2N327B	129	2N392	104	2N448	101
2N199	102	2N263	108	2N328	129	2N393	126	2N449	101
2N200	102	2N264	108	2N328A	129	2N394	100	2N450	100
2N204	102	2N265	102	2N328B	129	2N394A	100	2N456	104
2N205	102	2N266	102	2N329	129	2N395	100	2N456A	104

## TRANSISTORS (cont'd)

Type To Be Replaced	Sylvania ECG Replacement	Type To Be Replaced	Sylvania ECG Replacement	Type To Be Replaced	Sylvania ECG Replacement	Type To Be Replaced	Sylvania ECG Replacement	Type To Be Replaced	Sylvania ECG Replacement
2N456B	104	2N514	121	2N574A	105	2N639B	104	2N717A	108
2N457	104	2N514A	121	2N575	105	2N640	126	2N718	108
2N457A	104	2N514B	121	2N575A	105	2N641	126	2N718A	108
2N457B	104	2N515	101	2N576	101	2N641REDM/F	126	2N721	106
2N458	104	2N516	101	2N576A	101	2N642	126	2N721A	106
2N458A	104	2N517	101	2N578	100	2N643	126	2N722	106
2N458B	121	2N518	126	2N579	100	2N644	126	2N722A	106
2N459	121	2N519	100	2N580	100	2N645	126	2N723	106
2N459A	121	2N519A	100	2N581	100	2N646	103	2N725	126
2N460	102	2N520	100	2N582	102	2N647	103	2N726	106
2N461	102	2N520A	100	2N583	100	2N647/22	103	2N727	106
2N462	102	2N521	100	2N584	102	2N648	103	2N728	123
2N464	102	2N521A	100	2N585	101	2N649	103	2N729	123
2N465	102	2N522	102	2N586	100	2N649/5	102	2N741	126
2N466	102	2N522A	100	2N587	101	2N650	102	2N741A	126
2N467	102	2N523	102	2N588	126	2N650A	102	2N742	123
2N468	102	2N523A	100	2N588A	126	2N651	102	2N742A	123
2N470	123	2N524	102	2N589	121	2N651A	102	2N743	108
2N471	123	2N524A	102	2N591	102	2N652	102	2N743A	108
2N471A	123	2N525	102	2N591A	102	2N652A	102	2N744	108
2N472	123	2N525A	102	2N591/5	102	2N653	102	2N745	123
2N472A	123	2N526	102	2N591-6M	126	2N654	102	2N746	123
2N473	123	2N526A	102	2N592	100	2N655	102	2N747	123
2N474	123	2N527	102	2N593	100	2N655RED	102	2N748	123
2N474A	123	2N527A	102	2N594	101	2N655GRN	102	2N749	123
2N475	108	2N529	126	2N595	101	2N656	128	2N750	123
2N475A	108	2N530	100	2N596	100	2N656A	128	2N751	123
2N476	123	2N531	100	2N597	100	2N657	100	2N752	108
2N477	123	2N532	100	2N598	100	2N658	100	2N753	108
2N478	123	2N533	100	2N599	100	2N659	100	2N754	123
2N479	123	2N534	126	2N600	100	2N660	100	2N756	108
2N479A	123	2N535	102	2N602	126	2N661	100	2N756A	123
2N480	123	2N535A	102	2N602A	126	2N662	100	2N757	108
2N480A	108	2N535B	102	2N603	126	2N663	121	2N757A	123
2N480B	123	2N536	102	2N603A	126	2N665	121	2N758	108
2N481	100	2N537	126	2N604	126	2N669	121	2N758A	123
2N482	100	2N538	121	2N604A	126	2N672	100	2N758B	123
2N483	100	2N538A	121	2N605	126	2N674	100	2N759	108
2N483B	102	2N539	104	2N606	126	2N677	121	2N759A	123
2N483-6M	102	2N539A	104	2N607	126	2N677A	121	2N759B	123
2N484	100	2N540	104	2N608	126	2N677B	121	2N760	108
2N485	100	2N540A	104	2N609	102	2N677C	121	2N760A	123
2N486	100	2N541	107	2N610	102	2N678	121	2N760B	123
2N486B	100	2N542	107	2N611	102	2N678A	121	2N761	108
2N487	102	2N542A	123	2N612	102	2N678B	121	2N762	108
2N495	106	2N543	108	2N613	102	2N678C	102	2N768	126
2N495/18	106	2N543A	108	2N614	100	2N679	101	2N769	126
2N496	106	2N544	126	2N615	100	2N680	126	2N770	123
2N497	128	2N544/33	126	2N616	100	2N694	126	2N771	123
2N497A	128	2N546	123	2N617	100	2N695	126	2N772	123
2N498	128	2N547	123	2N618	121	2N696	123	2N773	123
2N499	126	2N548	123	2N619	108	2N697	123	2N774	123
2N499A	126	2N549	123	2N620	108	2N697A	123	2N775	123
2N500	126	2N550	123	2N621	108	2N700	126	2N776	123
2N500RED	126	2N551	123	2N622	108	2N700A	126	2N777	123
2N500BLU	126	2N552	123	2N623	126	2N700/18	126	2N778	123
2N500WHT	126	2N553	121	2N624	126	2N700A/18	126	2N779	126
2N501	126	2N554	101	2N625	103	2N701	121	2N779A	108
2N501A	126	2N555	121	2N627	121	2N702	108	2N779B	126
2N501/18	126	2N556	101	2N628	121	2N703	108	2N780	108
2N502	126	2N557	101	2N629	121	2N705	126	2N781	102
2N502A	126	2N558	101	2N630	121	2N705A	126	2N782	102
2N502B	126	2N559	126	2N631	102	2N706	108	2N783	108
2N503	126	2N560	123	2N632	102	2N706A	108	2N784	108
2N504	126	2N561	121	2N633	102	2N706B	108	2N784A	108
2N505	126	2N563	102	2N633B	102	2N706C	123	2N789	123
2N506	102	2N564	102	2N634	102	2N707	108	2N790	123
2N507	103	2N565	102	2N634A	101	2N707A	123	2N791	123
2N508	102	2N566	102	2N635	101	2N708	108	2N792	123
2N508A	102	2N567	102	2N635A	101	2N708A	108	2N793	123
2N509	100	2N568	102	2N636	101	2N709	108	2N794	126
2N511	104	2N569	102	2N636A	101	2N709A	108	2N795	126
2N511A	104	2N570	102	2N637	104	2N709/52	108	2N796	126
2N511B	104	2N571	102	2N637A	104	2N710	126	2N797	103
2N512	104	2N572	102	2N637B	104	2N710A	126	2N799	102
2N512A	104	2N573	102	2N638	104	2N711	126	2N800	102
2N512B	104	2N573BRN	102	2N638A	104	2N711A	126	2N801	100
2N513	104	2N573RED	102	2N638B	104	2N711B	126	2N802	100
2N513A	104	2N573ORN	102	2N639	104	2N715	123	2N803	100
2N513B	104	2N574	105	2N639A	104	2N717	108	2N804	100

TRANSISTORS (cont'd)

Type To Be Replaced	Sylvania ECG Replacement	Type To Be Replaced	Sylvania ECG Replacement	Type To Be Replaced	Sylvania ECG Replacement	Type To Be Replaced	Sylvania ECG Replacement	Type To Be Replaced	Sylvania ECG Replacement
2N805	100	2N930	123	2N1021A	121	2N1110	100	2N1167A	121
2N806	100	2N930A	108	2N1022	121	2N1111	102	2N1168	121
2N807	100	2N933	126	2N1022A	121	2N1111A	102	2N1169	103
2N808	100	2N934	126	2N1023	126	2N1111B	102	2N1170	103
2N809	100	2N935	123	2N1024	106	2N1111RED	102	2N1171	100
2N810	100	2N936	123	2N1025	106	2N1112	101	2N1172	104
2N811	100	2N937	123	2N1026	106	2N1114	101	2N1173	103
2N812	100	2N938	123	2N1026A	106	2N1115	100	2N1173W	103
2N813	100	2N939	123	2N1027	106	2N1115A	100	2N1174	103
2N814	100	2N940	123	2N1028	106	2N1116	123	2N1175	102
2N815	101	2N941	123	2N1029	121	2N1117	123	2N1175A	102
2N816	101	2N942	123	2N1029A	121	2N1118	126	2N1176	100
2N817	101	2N943	123	2N1029B	121	2N1118A	126	2N1176A	126
2N818	101	2N944	123	2N1029C	121	2N1119	106	2N1176B	126
2N819	101	2N945	123	2N1030	121	2N1120	121	2N1177	126
2N820	101	2N946	123	2N1030A	121	2N1121	101	2N1178	126
2N821	101	2N947	123	2N1030B	121	2N1122	100	2N1179	126
2N822	101	2N955	101	2N1030C	101	2N1122A	101	2N1180	126
2N823	101	2N955A	101	2N1031	121	2N1123	104	2N1182	121
2N824	101	2N957	108	2N1031A	121	2N1124	102	2N1183	121
2N825	102	2N960	126	2N1031B	121	2N1125	102	2N1183A	121
2N826	102	2N960/46	126	2N1031C	121	2N1126	102	2N1183B	121
2N827	126	2N961	126	2N1032	121	2N1127	102	2N1184	121
2N828	126	2N961/46	126	2N1032A	121	2N1128	102	2N1184A	121
2N828A	126	2N962	126	2N1032B	121	2N1129	102	2N1184B	121
2N829	126	2N963	126	2N1032C	121	2N1130	102	2N1185	100
2N834	108	2N964	126	2N1033	121	2N1131	106	2N1186	100
2N834A	123	2N964A	126	2N1034	106	2N1131A	106	2N1187	100
2N835	108	2N964/46	126	2N1035	106	2N1132	106	2N1188	100
2N837	100	2N965	126	2N1036	106	2N1132A	106	2N1189	102
2N838	126	2N966	126	2N1037	106	2N1132B	129	2N1190	102
2N839	108	2N967	126	2N1038	104	2N1132/46	129	2N1191	102
2N840	108	2N968	126	2N1040	104	2N1135	129	2N1192	102
2N841	108	2N969	126	2N1042	126	2N1135A	129	2N1193	102
2N842	108	2N970	126	2N1043	126	2N1136	104	2N1194	102
2N843	108	2N971	126	2N1044	102	2N1136A	104	2N1195	126
2N844	123	2N972	126	2N1045	102	2N1136B	104	2N1198	103
2N846	126	2N973	126	2N1046	127	2N1137	104	2N1199A	128
2N846A	126	2N974	126	2N1046A	127	2N1137A	121	2N1200	123
2N846B	126	2N975	126	2N1046B	127	2N1137B	121	2N1201	123
2N849	108	2N976	126	2N1051	123	2N1138	104	2N1202	105
2N850	108	2N977	126	2N1054	123	2N1138A	121	2N1203	105
2N851	108	2N978	126	2N1056	102	2N1138B	121	2N1204	100
2N852	108	2N979	126	2N1057	102	2N1141	100	2N1204A	126
2N858	106	2N980	126	2N1058	101	2N1141A	100	2N1205	123
2N859	106	2N981	126	2N1059	103	2N1142	100	2N1213	126
2N860	106	2N982	126	2N1060	108	2N1142A	100	2N1214	126
2N861	106	2N983	126	2N1065	126	2N1143	100	2N1215	126
2N862	106	2N984	126	2N1066	126	2N1143A	100	2N1216	126
2N863	106	2N985	126	2N1069	130	2N1144	102	2N1217	103
2N864	106	2N986	126	2N1070	130	2N1145	102	2N1218	121
2N864A	106	2N987	126	2N1073	127	2N1146	104	2N1219	106
2N865	106	2N988	108	2N1073A	127	2N1146A	104	2N1220	106
2N865A	106	2N989	108	2N1073B	127	2N1146B	104	2N1221	106
2N866	123	2N990	126	2N1078	121	2N1146C	104	2N1222	106
2N867	123	2N991	126	2N1081	123	2N1147	104	2N1223	106
2N869	106	2N992	126	2N1082	123	2N1147A	104	2N1224	126
2N869A	106	2N993	100	2N1086	101	2N1147B	104	2N1225	126
2N909	123	2N994	126	2N1086A	101	2N1147C	104	2N1226	126
2N913	108	2N995	106	2N1087	101	2N1149	123	2N1227	104
2N914	108	2N995A	106	2N1090	101	2N1150	123	2N1227A	104
2N914A	108	2N996	106	2N1091	101	2N1151	123	2N1227-3	104
2N914/51	108	2N1000	101	2N1092	123	2N1152	123	2N1227-4	104
2N916	108	2N1003	126	2N1093	126	2N1153	123	2N1227-4R	104
2N916A	108	2N1004	126	2N1094	126	2N1157	105	2N1228	106
2N917	108	2N1005	108	2N1095	103	2N1157A	105	2N1229	106
2N917A	108	2N1006	128	2N1096	103	2N1158	100	2N1230	106
2N918	108	2N1007	104	2N1097	102	2N1159	121	2N1231	106
2N919	108	2N1008	102	2N1098	102	2N1160	121	2N1232	106
2N920	108	2N1008A	102	2N1099	105	2N1162	104	2N1233	106
2N921	108	2N1008B	102	2N1100	105	2N1162A	104	2N1238	106
2N922	108	2N1009	102	2N1101	103	2N1163	121	2N1239	106
2N923	106	2N1010	102	2N1102	103	2N1163A	121	2N1240	106
2N924	106	2N1011	121	2N1102/5	103	2N1164	104	2N1241	106
2N925	106	2N1012	101	2N1103	123	2N1164A	104	2N1245	104
2N926	106	2N1014	121	2N1104	123	2N1165	104	2N1246	104
2N927	106	2N1017	101	2N1107	100	2N1165A	121	2N1247	123
2N928	106	2N1018	101	2N1108	100	2N1166	100	2N1248	123
2N929	123	2N1020	121	2N1108RED	126	2N1166A	121	2N1249	123
2N929A	123	2N1021	121	2N1109	126	2N1167	104	2N1251	103

## TRANSISTORS (cont'd)

Type To Be Replaced	Sylvania ECC Replacement	Type To Be Replaced	Sylvania ECC Replacement	Type To Be Replaced	Sylvania ECC Replacement	Type To Be Replaced	Sylvania ECC Replacement	Type To Be Replaced	Sylvania ECC Replacement
2N1252	128	2N1352	102	2N1435	105	2N1536A	121	2N1636	126
2N1253	128	2N1353	102	2N1436	126	2N1537	121	2N1637	126
2N1254	129	2N1354	100	2N1439	129	2N1537A	121	2N1638	126
2N1255	129	2N1355	100	2N1440	129	2N1538	121	2N1639	126
2N1256	129	2N1356	100	2N1441	129	2N1538A	121	2N1640	106
2N1257	129	2N1357	100	2N1442	129	2N1539	121	2N1641	106
2N1258	129	2N1358	105	2N1443	129	2N1539A	121	2N1642	106
2N1259	129	2N1358A	105	2N1446	102	2N1540	121	2N1643	106
2N1261	105	2N1358M	105	2N1447	102	2N1540A	121	2N1644	123
2N1262	105	2N1359	121	2N1448	102	2N1541	121	2N1644A	123
2N1263	105	2N1360	121	2N1449	102	2N1541A	121	2N1646	126
2N1264	126	2N1361	100	2N1450	102	2N1542	121	2N1651	121
2N1265	102	2N1361A	100	2N1451	102	2N1542A	121	2N1652	121
2N1265/5	102	2N1362	121	2N1452	102	2N1543	121	2N1653	121
2N1266	102	2N1363	121	2N1469	100	2N1543A	121	2N1663	128
2N1273	102	2N1364	121	2N1470	100	2N1544	121	2N1664	100
2N1273RED	102	2N1365	121	2N1471	100	2N1544A	121	2N1665	100
2N1273ORN	102	2N1366	101	2N1473	101	2N1545	121	2N1666	104
2N1273YEL	102	2N1367	101	2N1474	129	2N1545A	121	2N1667	121
2N1273GRN	102	2N1370	102	2N1474A	129	2N1546	121	2N1668	104
2N1273BLU	102	2N1371	102	2N1475	129	2N1546A	121	2N1669	104
2N1274	102	2N1372	102	2N1478	102	2N1547	121	2N1670	100
2N1274BRN	102	2N1373	102	2N1479	128	2N1547A	121	2N1672	103
2N1274RED	102	2N1374	102	2N1480	128	2N1548	121	2N1672A	103
2N1274ORN	102	2N1375	102	2N1481	128	2N1548A	121	2N1673	100
2N1274GRN	102	2N1376	102	2N1482	128	2N1549	121	2N1674	123
2N1274BLU	102	2N1377	102	2N1487	130	2N1549A	121	2N1676	106
2N1274PUR	102	2N1378	102	2N1488	130	2N1550	121	2N1677	106
2N1276	123	2N1379	102	2N1489	130	2N1550A	121	2N1678	126
2N1277	123	2N1380	102	2N1490	130	2N1551	121	2N1681	100
2N1278	123	2N1381	102	2N1491	123	2N1551A	121	2N1682	123
2N1279	123	2N1382	102	2N1492	123	2N1552	121	2N1683	100
2N1280	100	2N1383	102	2N1494	126	2N1552A	121	2N1684	100
2N1281	100	2N1384	126	2N1495	126	2N1553	121	2N1685	101
2N1282	100	2N1385	126	2N1499	126	2N1553A	121	2N1694	101
2N1284	100	2N1386	123	2N1499A	126	2N1554	121	2N1699	126
2N1285	100	2N1387	123	2N1499B	126	2N1554A	121	2N1700	128
2N1287	102	2N1388	123	2N1500	126	2N1555	121	2N1702	130
2N1287A	102	2N1389	123	2N1500/18	126	2N1555A	121	2N1704	123
2N1289	101	2N1391	103	2N1501	104	2N1556	121	2N1705	102
2N1289	101	2N1392	102	2N1502	104	2N1556A	121	2N1706	102
2N1291	104	2N1393	100	2N1505	108	2N1557	121	2N1707	102
2N1292	121	2N1395	126	2N1506	108	2N1557A	121	2N1708	123
2N1293	104	2N1396	126	2N1506A	108	2N1558	121	2N1708A	128
2N1294	121	2N1397	126	2N1507	108	2N1558A	121	2N1726	126
2N1295	104	2N1398	126	2N1510	101	2N1559	121	2N1727	126
2N1296	104	2N1399	126	2N1515	126	2N1559A	121	2N1728	126
2N1297	121	2N1400	126	2N1516	126	2N1560	121	2N1730	101
2N1299	101	2N1401	126	2N1517	126	2N1560A	121	2N1731	100
2N1300	100	2N1401A	126	2N1517A	126	2N1561	126	2N1732	101
2N1301	100	2N1402	126	2N1518	105	2N1562	126	2N1742	126
2N1302	101	2N1403	100	2N1519	105	2N1570	100	2N1743	126
2N1303	102	2N1404	102	2N1520	105	2N1581	100	2N1744	126
2N1304	101	2N1404A	126	2N1521	105	2N1583	100	2N1745	126
2N1305	100	2N1405	126	2N1522	105	2N1584	100	2N1746	126
2N1306	101	2N1406	126	2N1523	105	2N1585	101	2N1747	126
2N1307	100	2N1407	126	2N1524	126	2N1586	123	2N1748	126
2N1308	101	2N1408	126	2N1524-1	126	2N1587	123	2N1748A	126
2N1309	100	2N1409	126	2N1524-2	126	2N1589	123	2N1749	126
2N1309A	102	2N1410	126	2N1524/33	126	2N1590	123	2N1750	126
2N1310	101	2N1411	126	2N1525	126	2N1591	123	2N1752	126
2N1311	101	2N1412	105	2N1526	126	2N1592	123	2N1753	126
2N1312	102	2N1413	102	2N1526/33	126	2N1593	123	2N1754	100
2N1313	126	2N1414	102	2N1527	126	2N1594	123	2N1755	104
2N1314	104	2N1415	102	2N1528	123	2N1601	122	2N1756	104
2N1314R	104	2N1416	102	2N1529	121	2N1602	122	2N1757	104
2N1316	100	2N1417	123	2N1529A	121	2N1605	101	2N1758	104
2N1317	100	2N1418	123	2N1530	121	2N1605A	101	2N1759	104
2N1318	100	2N1419	104	2N1530A	121	2N1606	129	2N1760	104
2N1319	100	2N1420	128	2N1531	121	2N1607	129	2N1761	104
2N1338	123	2N1425	126	2N1531A	121	2N1608	129	2N1762	104
2N1343	100	2N1426	126	2N1532	121	2N1614	102	2N1763	123
2N1344	100	2N1427	126	2N1532A	121	2N1622	101	2N1764	128
2N1345	100	2N1428	129	2N1533	121	2N1623	129	2N1772	122
2N1346	100	2N1429	129	2N1534	121	2N1624	101	2N1773	122
2N1347	100	2N1430	121	2N1534A	121	2N1631	126	2N1774	122
2N1348	102	2N1431	103	2N1535	121	2N1632	121	2N1779	101
2N1349	100	2N1432	102	2N1535A	121	2N1633	126	2N1780	101
2N1350	100	2N1433	105	2N1535B	121	2N1634	126	2N1781	101
2N1351	100	2N1434	105	2N1536	121	2N1635	126	2N1782	100

TRANSISTORS (cont'd)

Type To Be Replaced	Sylvania ECG Replacement	Type To Be Replaced	Sylvania ECG Replacement	Type To Be Replaced	Sylvania ECG Replacement	Type To Be Replaced	Sylvania ECG Replacement	Type To Be Replaced	Sylvania ECG Replacement
2N1783	100	2N1992	128	2N2105	129	2N2195A	108	2N2331	123
2N1784	100	2N1993	101	2N2106	128	2N2195B	108	2N2332	106
2N1785	126	2N1994	101	2N2107	128	2N2196	108	2N2333	129
2N1786	126	2N1995	101	2N2108	128	2N2197	108	2N2334	106
2N1787	126	2N1996	101	2N2137	104	2N2198	123	2N2335	106
2N1788	126	2N1997	100	2N2137A	104	2N2199	126	2N2336	106
2N1789	126	2N1998	100	2N2138	104	2N2200	129	2N2337	106
2N1790	126	2N1999	100	2N2138A	104	2N2204	124	2N2349	123
2N1808	101	2N2000	100	2N2139	104	2N2205	123	2N2353	123
2N1838	123	2N2001	100	2N2139A	104	2N2206	108	2N2353A	123
2N1839	123	2N2002	106	2N2140	104	2N2207	126	2N2354	103
2N1840	123	2N2003	106	2N2140A	104	2N2208	126	2N2357	121
2N1853	100	2N2004	106	2N2141	104	2N2209	106	2N2358	121
2N1854	102	2N2005	106	2N2141A	104	2N2210	105	2N2360	126
2N1858	103	2N2006	106	2N2142	104	2N2212	124	2N2361	126
2N1864	126	2N2007	106	2N2142A	104	2N2221	128	2N2362	126
2N1865	126	2N2017	128	2N2143	104	2N2222	108	2N2363	128
2N1866	126	2N2022	126	2N2143A	104	2N2225	120	2N2368	128
2N1867	126	2N2032	108	2N2144	104	2N2234	123	2N2369	128
2N1868	126	2N2038	123	2N2144A	104	2N2235	123	2N2369A	128
2N1891	101	2N2039	123	2N2145	104	2N2236	123	2N2370	106
2N1892	101	2N2040	123	2N2145A	104	2N2237	123	2N2371	106
2N1893	123	2N2041	123	2N2146	104	2N2238	126	2N2372	106
2N1905	121	2N2048	126	2N2146A	104	2N2240	123	2N2373	106
2N1906	121	2N2048A	102	2N2147	104	2N2241	123	2N2374	102
2N1907	121	2N2059	126	2N2148	121	2N2242	108	2N2375	102
2N1908	104	2N2061	104	2N2152	105	2N2244	108	2N2376	102
2N1917	106	2N2061A	121	2N2152A	105	2N2245	108	2N2377	106
2N1918	106	2N2062	104	2N2153	105	2N2246	108	2N2378	106
2N1919	106	2N2062A	104	2N2153A	105	2N2247	108	2N2381	126
2N1920	106	2N2063	104	2N2154	105	2N2248	108	2N2382	126
2N1921	106	2N2063A	104	2N2154A	105	2N2249	108	2N2387	123
2N1924	102	2N2064	104	2N2155	105	2N2250	108	2N2388	123
2N1925	102	2N2064A	104	2N2155A	105	2N2251	108	2N2389	123
2N1926	102	2N2065	104	2N2156	105	2N2252	108	2N2390	123
2N1931	122	2N2065A	104	2N2156A	105	2N2253	108	2N2393	106
2N1932	122	2N2066	104	2N2157	105	2N2254	108	2N2394	106
2N1933	122	2N2066A	104	2N2157A	105	2N2255	108	2N2395	106
2N1940	100	2N2067	104	2N2158	105	2N2256	108	2N2396	123
2N1944	108	2N2067B	104	2N2158A	105	2N2257	108	2N2397	123
2N1945	108	2N2067G	104	2N2159	105	2N2258	126	2N2398	126
2N1946	108	2N2067W	104	2N2159A	105	2N2259	126	2N2399	126
2N1947	108	2N2069	104	2N2161	123	2N2266	105	2N2400	126
2N1948	108	2N2070	104	2N2162	106	2N2267	105	2N2401	126
2N1949	108	2N2075	105	2N2163	106	2N2268	105	2N2402	126
2N1950	108	2N2075A	105	2N2164	106	2N2269	105	2N2411	106
2N1951	108	2N2076	105	2N2165	106	2N2271	102	2N2412	106
2N1952	108	2N2076A	105	2N2166	106	2N2272	123	2N2413	108
2N1953	123	2N2077	105	2N2167	106	2N2273	126	2N2415	126
2N1954	100	2N2077A	105	2N2168	126	2N2274	106	2N2416	126
2N1955	100	2N2078	105	2N2169	126	2N2275	106	2N2423	121
2N1956	100	2N2078A	105	2N2170	126	2N2276	106	2N2424	106
2N1957	100	2N2079	105	2N2171	100	2N2277	106	2N2425	106
2N1958	123	2N2079A	105	2N2172	100	2N2278	106	2N2426	103
2N1959	123	2N2080	105	2N2173	102	2N2280	106	2N2427	108
2N1960	100	2N2080A	105	2N2175	106	2N2281	106	2N2428	102
2N1960/46	100	2N2081	105	2N2176	106	2N2282	104	2N2429	102
2N1961	100	2N2081A	105	2N2177	106	2N2285	104	2N2430	101
2N1962	128	2N2082	105	2N2178	106	2N2286	104	2N2431	102
2N1963	128	2N2082A	105	2N2180	126	2N2287	121	2N2432	128
2N1964	128	2N2083	126	2N2181	129	2N2288	104	2N2446	121
2N1965	128	2N2084	126	2N2182	129	2N2289	121	2N2447	102
2N1969	100	2N2085	101	2N2183	129	2N2290	121	2N2448	102
2N1970	105	2N2089	126	2N2184	129	2N2291	104	2N2449	102
2N1971	104	2N2090	126	2N2185	129	2N2292	121	2N2450	102
2N1972	123	2N2091	126	2N2186	129	2N2293	121	2N2451	126
2N1973	123	2N2092	126	2N2187	129	2N2294	121	2N2455	126
2N1974	123	2N2093	126	2N2188	126	2N2295	121	2N2456	126
2N1975	123	2N2094	123	2N2189	126	2N2296	121	2N2466	106
2N1980	105	2N2094A	123	2N2190	126	2N2303	106	2N2468	102
2N1981	105	2N2095	123	2N2191	126	2N2305	130	2N2469	102
2N1982	105	2N2095A	123	2N2192	108	2N2309	123	2N2476	123
2N1983	123	2N2096A	128	2N2192A	108	2N2310	123	2N2477	123
2N1984	123	2N2097	126	2N2193	108	2N2312	123	2N2481	108
2N1985	123	2N2097A	128	2N2193A	108	2N2314	123	2N2482	103
2N1986	123	2N2098	126	2N2193B	108	2N2315	123	2N2483	128
2N1987	123	2N2099	126	2N2194	123	2N2318	106	2N2484	128
2N1988	123	2N2100	126	2N2194A	123	2N2319	123	2N2487	126
2N1989	108	2N2102	128	2N2194B	123	2N2320	123	2N2488	126
2N1991	106	2N2104	129	2N2195	108	2N2330	123	2N2489	126

## TRANSISTORS (cont'd)

Type To Be Replaced	Sylvania ECG Replacement	Type To Be Replaced	Sylvania ECG Replacement	Type To Be Replaced	Sylvania ECG Replacement	Type To Be Replaced	Sylvania ECG Replacement	Type To Be Replaced	Sylvania ECG Replacement
2N2490	105	2N2672GRN	100	2N2894A	106	2N3117	123	2N3322	126
2N2491	105	2N2673	108	2N2904	106	2N3121	129	2N3323	100
2N2492	105	2N2674	108	2N2904A	106	2N3122	123	2N3324	100
2N2493	105	2N2675	128	2N2905	106	2N3125	121	2N3325	100
2N2494	126	2N2676	128	2N2905A	106	2N3132	121	2N3338	108
2N2495	126	2N2677	128	2N2906	106	2N3133	106	2N3339	108
2N2496	126	2N2678	128	2N2906A	129	2N3134	106	2N3340	108
2N2501	108	2N2692	128	2N2907	106	2N3135	106	2N3341	106
2N2512	102	2N2693	128	2N2907A	106	2N3136	106	2N3342	106
2N2520	123	2N2695	129	2N2921	128	2N3137	107	2N3343	106
2N2521	123	2N2696	129	2N2922	128	2N3148	126	2N3344	106
2N2522	123	2N2699	101	2N2923	128	2N3153	126	2N3345	106
2N2523	123	2N2706	102	2N2924	123	2N3202	129	2N3346	106
2N2524	123	2N2707	103	2N2925	123	2N3203	129	2N3371	100
2N2526	127	2N2708	108	2N2926	123	2N3208	129	2N3390	123
2N2527	127	2N2709	129	2N2926GORN	128	2N3209	106	2N3391	123
2N2528	127	2N2710	108	2N2926GRN	128	2N3210	123	2N3391A	123
2N2529	123	2N2711	108	2N2926-6	128	2N3211	123	2N3392	123
2N2530	123	2N2712	123	2N2927	129	2N3212	121	2N3393	123
2N2531	123	2N2713	123	2N2928	126	2N3213	121	2N3394	123
2N2532	123	2N2714	108	2N2929	100	2N3214	121	2N3395	123
2N2533	123	2N2715	108	2N2930	121	2N3215	106	2N3396	123
2N2534	123	2N2716	123	2N2931	123	2N3216	102	2N3397	123
2N2539	128	2N2717	126	2N2932	123	2N3217	106	2N3398	123
2N2540	128	2N2719	128	2N2933	123	2N3218	106	2N3399	108
2N2541	102	2N2728	105	2N2934	123	2N3219	106	2N3400	100
2N2553	102	2N2729	108	2N2935	123	2N3226	108	2N3401	106
2N2555	102	2N2730	105	2N2938	128	2N3227	129	2N3402	108
2N2564	102	2N2731	105	2N2942	102	2N3228	122	2N3403	123
2N2565	102	2N2732	105	2N2943	102	2N3232	130	2N3404	123
2N2569	128	2N2783	126	2N2944	106	2N3241	123	2N3405	123
2N2570	128	2N2784	108	2N2945	129	2N3241A	123	2N3407	108
2N2571	128	2N2784/52	108	2N2945A	129	2N3242	123	2N3412	100
2N2572	128	2N2785	100	2N2946	129	2N3242A	123	2N3414	123
2N2586	128	2N2786A	100	2N2946A	129	2N3245	106	2N3415	108
2N2587	126	2N2793	105	2N2949	128	2N3246	128	2N3416	128
2N2588	126	2N2795	126	2N2951	123	2N3247	123	2N3417	108
2N2595	129	2N2796	126	2N2952	128	2N3248	129	2N3427	102
2N2596	129	2N2797	102	2N2953	102	2N3249	129	2N3428	102
2N2597	129	2N2798	102	2N2955	126	2N3250	129	2N3440	124
2N2601	129	2N2799	100	2N2956	126	2N3250A	129	2N3443	100
2N2602	129	2N2800	106	2N2957	126	2N3251	106	2N3445	130
2N2603	129	2N2800/46	129	2N2958	123	2N3251A	129	2N3446	130
2N2604	129	2N2801	106	2N2959	123	2N3261	123	2N3447	130
2N2605	129	2N2802	106	2N2960	123	2N3267	100	2N3448	130
2N2605A	129	2N2803	106	2N2961	123	2N3268	123	2N3449	126
2N2610	128	2N2804	106	2N2966	100	2N3279	106	2N3451	129
2N2612	104	2N2805	106	2N2968	106	2N3280	126	2N3462	128
2N2613	102	2N2806	106	2N2969	106	2N3281	126	2N3463	128
2N2614	102	2N2807	106	2N2970	106	2N3282	126	2N3464	129
2N2616	108	2N2831	128	2N2971	106	2N3283	126	2N3469	128
2N2617	123	2N2832	121	2N2996	126	2N3284	126	2N3478	108
2N2618	123	2N2835	131	2N2997	126	2N3285	126	2N3485	106
2N2621	100	2N2836	121	2N2998	126	2N3286	126	2N3485A	129
2N2622	100	2N2837	106	2N2999	126	2N3287	108	2N3486	106
2N2623	100	2N2838	106	2N3009	123	2N3288	108	2N3486A	129
2N2624	100	2N2845	129	2N3010	108	2N3289	108	2N3493	108
2N2625	100	2N2846	128	2N3011	108	2N3290	108	2N3496	129
2N2626	100	2N2847	129	2N3012	106	2N3291	108	2N3498	123
2N2627	100	2N2848	128	2N3013	123	2N3292	108	2N3502	129
2N2628	100	2N2849	128	2N3014	123	2N3293	108	2N3503	129
2N2629	100	2N2850	128	2N3015	123	2N3294	108	2N3504	129
2N2630	100	2N2851	128	2N3035	108	2N3301	128	2N3505	129
2N2635	126	2N2852	128	2N3053	128	2N3302	128	2N3506	128
2N2636	121	2N2853	128	2N3054	152	2N3304	106	2N3507	128
2N2637	121	2N2854	128	2N3055	130	2N3305	106	2N3508	108
2N2639	108	2N2855	128	2N3058	106	2N3306	106	2N3509	108
2N2640	108	2N2856	128	2N3059	129	2N3307	106	2N3510	128
2N2641	108	2N2857	108	2N3060	129	2N3308	106	2N3511	108
2N2642	108	2N2860	100	2N3072	100	2N3310	123	2N3527	108
2N2643	108	2N2861	106	2N3073	129	2N3311	105	2N3544	108
2N2644	108	2N2862	106	2N3074	126	2N3312	105	2N3545	129
2N2648	102	2N2865	108	2N3075	126	2N3313	105	2N3546	106
2N2651	108	2N2869	121	2N3077	123	2N3314	105	2N3547	129
2N2654	126	2N2869/2N301	121	2N3078	123	2N3315	105	2N3548	129
2N2656	128	2N2870	121	2N3081	106	2N3317	106	2N3549	129
2N2671	126	2N2873	126	2N3082	107	2N3318	106	2N3550	129
2N2672	126	2N2883	108	2N3083	107	2N3319	106	2N3563	108
2N2672A	100	2N2884	108	2N3115	108	2N3320	126	2N3563-1	108
2N2672BLK	100	2N2894	106	2N3116	108	2N3321	126	2N3564	108

TRANSISTORS (cont'd)

Type To Be Replaced	Sylvania ECC Replacement	Type To Be Replaced	Sylvania ECC Replacement	Type To Be Replaced	Sylvania ECC Replacement	Type To Be Replaced	Sylvania ECC Replacement	Type To Be Replaced	Sylvania ECC Replacement
2N3565	123	2N3770	126	2N4059	106	2N5110	129	2S49	100
2N3566	128	2N3771	130	2N4060	106	2N5111	129	2S51	100
2N3567	128	2N3772	130	2N4061	106	2N5126	123	2S52	100
2N3568	128	2N3774	129	2N4062	106	2N5127	123	2S53	100
2N3569	128	2N3775	129	2N4072	108	2N5128	123	2S54	102
2N3570	108	2N3776	129	2N4073	108	2N5129	123	2S56	102
2N3571	108	2N3778	129	2N4074	108	2N5130	123	2S58	126
2N3572	108	2N3779	129	2N4078	131	2N5131	123	2S60	100
2N3576	106	2N3780	129	2N4080	106	2N5132	123	2S91	100
2N3579	129	2N3782	129	2N4086	108	2N5135	123	2S92	100
2N3580	129	2N3793	108	2N4087	108	2N5136	123	2S92A	100
2N3581	106	2N3794	108	2N4087A	108	2N5137	123	2S93	100
2N3582	106	2N3798	106	2N4105	103	2N5163	132	2S93A	100
2N3583	124	2N3799	106	2N4106	121	2N5172	123	2S95A	128
2N3588	126	2N3819	132	2N4121	106	2N5180	108	2S96	126
2N3600	108	2N3820	132	2N4122	106	2N5183	123	2S98	126
2N3605	108	2N3825	128	2N4123	128	2N5190	152	2S101	128
2N3606	108	2N3826	107	2N4124	128	2N5191	152	2S102	128
2N3607	107	2N3827	107	2N4125	106	2N5193	153	2S103	128
2N3611	121	2N3828	107	2N4134	108	2N5194	153	2S104	128
2N3612	121	2N3829	106	2N4140	128	2N5200	123	2S109	126
2N3613	121	2N3832	108	2N4141	108	2N5201	100	2S110	126
2N3614	121	2N3840	129	2N4142	129	2N5248	132	2S111	100
2N3615	121	2N3843	128	2N4143	106	2N5354	129	2S112	126
2N3616	121	2N3843A	128	2N4234	129	2NJ5A	100	2S131	128
2N3617	121	2N3844	128	2N4235	129	2NJ6	100	2S141	126
2N3618	121	2N3844A	128	2N4237	128	2NJ8A	100	2S142	126
2N3633	108	2N3845	128	2N4241	121	2NJ9A	102	2S143	126
2N3638	129	2N3845A	128	2N4248	128	2NJD9D	102	2S145	126
2N3638A	129	2N3846	107	2N4249	128	2NJ50	126	2S146	126
2N3639	106	2N3854	128	2N4250	129	2NJ51	126	2S155	100
2N3640	106	2N3854A	128	2N4251	108	2NJ52	126	2S159	100
2N3641	108	2N3855	128	2N4254	107	2NJ53	126	2S160	100
2N3642	108	2N3855A	128	2N4255	107	2NNS31	102	2S163	102
2N3643	108	2N3856	128	2N4256	108	2NNS32	102	2S167	100
2N3644	129	2N3856A	128	2N4257	106	2NS121	102	2S174	100
2N3645	106	2N3857	129	2N4259	128	2S001	128	2S176	126
2N3646	108	2N3858	128	2N4274	128	2S002	128	2S178	100
2N3647	123	2N3858A	128	2N4275	128	2S003	128	2S179	102
2N3648	123	2N3859	128	2N4286	123	2S004	128	2S189	102
2N3662	108	2N3859A	128	2N4287	123	2S005	128	2S301	129
2N3663	108	2N3860	128	2N4288	106	2S006	108	2S302	129
2N3667	130	2N3862	123	2N4290	106	2S014	128	2S302A	129
2N3671	128	2N3863	130	2N4291	106	2S017	128	2S303	129
2N3672	106	2N3864	130	2N4296	124	2S019	128	2S304	129
2N3673	106	2N3866	123	2N4297	124	2S022	129	2S306	129
2N3677	129	2N3867	129	2N4298	124	2S023	129	2S307	129
2N3682	108	2N3869	123	2N4299	124	2S033	130	2S321	129
2N3688	108	2N3877	128	2N4346	127	2S034	130	2S322	129
2N3689	108	2N3880	128	2N4395	130	2S035	130	2S322A	129
2N3690	128	2N3883	100	2N4400	128	2S036	130	2S323	129
2N3691	108	2N3900	128	2N4401	128	2S12	100	2S324	129
2N3692	123	2N3900A	128	2N4402	129	2S13	100	2S326	129
2N3693	123	2N3901	128	2N4403	129	2S14	102	2S327	129
2N3694	123	2N3905	106	2N4410	128	2S15	102	2S501	128
2N3702	129	2N3906	106	2N4424	123	2S15A	102	2S502	128
2N3703	129	2N3911	106	2N4425	123	2S22	102	2S503	128
2N3704	128	2N3912	106	2N4910	124	2S24	102	2S512	108
2N3705	128	2N3914	106	2N4911	124	2S25	100	2S701	123
2N3706	128	2N3915	106	2N4912	124	2S26	121	2S702	123
2N3707	123	2N3924	123	2N4913	130	2S26A	121	2S703	123
2N3708	123	2N3932	108	2N4914	130	2S30	100	2S711	123
2N3709	123	2N3933	108	2N4916	129	2S31	100	2S712	123
2N3710	123	2N3973	123	2N4918	153	2S32	102	2S731	128
2N3711	123	2N3974	123	2N4919	153	2S33	102	2S732	128
2N3712	123	2N3975	123	2N4921	152	2S34	102	2S733	128
2N3713	130	2N3976	123	2N4922	152	2S35	126	2S741	128
2N3714	130	2N3977	106	2N4951	123	2S36	126	2S742	128
2N3715	130	2N3978	106	2N4952	123	2S37	102	2S743	128
2N3716	130	2N3979	106	2N4953	123	2S38	102	2S744	128
2N3719	129	2N3983	108	2N4954	123	2S39	102	2S745	128
2N3720	129	2N3984	108	2N4956	123	2S40	102	2S746	128
2N3721	107	2N3985	108	2N4967	123	2S41	104	2S3010	129
2N3730	127	2N3995	100	2N4968	123	2S41A	104	2S3020	129
2N3731	127	2N4013	123	2N4996	108	2S42	104	2S3021	106
2N3732	127	2N4014	123	2N4997	108	2S43	102	2S3030	129
2N3738	124	2N4032	106	2N5053	108	2S44	102	2S3040	106
2N3739	124	2N4034	106	2N5054	108	2S45	100	2S3210	129
2N3766	124	2N4035	106	2N5067	130	2S46	102	2S3220	129
2N3767	124	2N4058	106	2N5068	130	2S47	102	2S3221	129

## TRANSISTORS (cont'd)

Type To Be Replaced	Sylvania ECG Replacement	Type To Be Replaced	Sylvania ECG Replacement	Type To Be Replaced	Sylvania ECG Replacement	Type To Be Replaced	Sylvania ECG Replacement	Type To Be Replaced	Sylvania ECG Replacement
2S3230	129	2SA77C	126	2SA138	126	2SA220	126	2SA288A	126
2S3240	129	2SA77D	126	2SA139	126	2SA221	126	2SA289	100
2SA12	100	2SA78	100	2SA141	126	2SA222	126	2SA290	100
2SA12A	126	2SA79	100	2SA141B	126	2SA223	126	2SA291	126
2SA12B	126	2SA80	126	2SA141C	126	2SA224	126	2SA292	126
2SA12C	126	2SA81	126	2SA142	126	2SA225	126	2SA293	126
2SA12D	126	2SA82	126	2SA142B	126	2SA226	100	2SA294	126
2SA13	100	2SA83	126	2SA142C	126	2SA227	126	2SA295	126
2SA14	100	2SA84	126	2SA143	126	2SA228	100	2SA296	100
2SA15	100	2SA85	126	2SA144	100	2SA229	126	2SA297	100
2SA15V	100	2SA86	100	2SA144C	100	2SA230	126	2SA298	126
2SA15Y	102	2SA87	126	2SA145	100	2SA233	126	2SA301	100
2SA16	100	2SA88	126	2SA145C	100	2SA233A	126	2SA302	100
2SA17	100	2SA89	126	2SA146	100	2SA233B	126	2SA303	126
2SA18	100	2SA90	126	2SA147	100	2SA233C	126	2SA304	126
2SA19	126	2SA92	126	2SA148	100	2SA234	126	2SA305	126
2SA20	126	2SA93	126	2SA149	100	2SA234A	126	2SA306	126
2SA21	126	2SA94	126	2SA150	126	2SA234B	126	2SA307	126
2SA26	100	2SA100	100	2SA151	100	2SA234C	126	2SA308	126
2SA28	100	2SA100B	102	2SA152	100	2SA235	126	2SA309	126
2SA29	126	2SA100C	102	2SA153	126	2SA335A	126	2SA310	126
2SA30	126	2SA101	126	2SA154	126	2SA335B	126	2SA311	126
2SA31	100	2SA101A	126	2SA155	126	2SA235C	126	2SA312	126
2SA32	126	2SA101AA	126	2SA156	126	2SA236	126	2SA313	126
2SA33	126	2SA101AY	126	2SA157	126	2SA237	126	2SA314	126
2SA35	100	2SA101B	126	2SA159	126	2SA238	126	2SA315	126
2SA36	100	2SA101BA	126	2SA160	100	2SA239	126	2SA316	126
2SA37	100	2SA101BB	126	2SA161	126	2SA240	126	2SA321	126
2SA38	100	2SA101BC	126	2SA162	126	2SA240A	126	2SA322	126
2SA39	100	2SA101BX	126	2SA163	126	2SA240B	126	2SA323	126
2SA40	100	2SA101C	126	2SA164	126	2SA240B2	126	2SA324	126
2SA41	100	2SA101CA	126	2SA165	126	2SA240BL	126	2SA325	102
2SA42	100	2SA101E	126	2SA166	126	2SA241	126	2SA326	100
2SA43	126	2SA101X	126	2SA167	100	2SA242	126	2SA327	126
2SA44	100	2SA101Y	126	2SA168	100	2SA243	126	2SA329	126
2SA49	100	2SA101Z	100	2SA168A	100	2SA244	126	2SA329A	126
2SA50	100	2SA102	126	2SA169	100	2SA245	126	2SA329B	126
2SA51	100	2SA102AA	126	2SA170	100	2SA246	126	2SA330	100
2SA52	100	2SA102BA	126	2SA171	100	2SA246V	126	2SA331	126
2SA53	100	2SA103	126	2SA172	100	2SA247	126	2SA332	100
2SA54	100	2SA103A	126	2SA172A	100	2SA248	100	2SA335	126
2SA55	100	2SA103B	126	2SA173	100	2SA250	126	2SA337	126
2SA56	100	2SA103C	126	2SA174	102	2SA251	126	2SA338	126
2SA57	126	2SA103CA	126	2SA175	126	2SA252	126	2SA339	126
2SA58	126	2SA103CG	126	2SA176	126	2SA253	126	2SA340	126
2SA59	126	2SA103DA	126	2SA180	100	2SA254	126	2SA341	126
2SA60	126	2SA104	126	2SA181	100	2SA255	100	2SA341-OA	126
2SA61	100	2SA104D	126	2SA182	100	2SA256	126	2SA341-OB	126
2SA64	126	2SA104P	126	2SA183	100	2SA257	126	2SA342	126
2SA65	100	2SA105	126	2SA188	100	2SA258	126	2SA342A	126
2SA66	100	2SA106	126	2SA189	100	2SA259	126	2SA343	126
2SA67	126	2SA107	126	2SA197	102	2SA260	126	2SA344	126
2SA69	126	2SA108	126	2SA198	100	2SA261	126	2SA345	126
2SA70	126	2SA109	126	2SA201	100	2SA262	126	2SA346	126
2SA70F	126	2SA110	126	2SA201A	100	2SA263	126	2SA347	126
2SA70L	126	2SA111	126	2SA201B	126	2SA264	126	2SA348	126
2SA70MA	126	2SA112	126	2SA202	100	2SA265	126	2SA349	126
2SA70OB	126	2SA113	126	2SA202A	100	2SA266	126	2SA350	126
2SA70OY	126	2SA114	126	2SA202B	100	2SA267	100	2SA350A	126
2SA71	126	2SA115	126	2SA202C	100	2SA268	126	2SA350R	126
2SA71A	126	2SA116	126	2SA202D	100	2SA269	100	2SA350T	126
2SA71AB	126	2SA117	126	2SA203	100	2SA270	126	2SA350TY	126
2SA71AC	126	2SA118	126	2SA203A	100	2SA271	126	2SA350Y	126
2SA71B	126	2SA121	126	2SA203B	100	2SA272	126	2SA351	126
2SA71D	126	2SA122	126	2SA204	100	2SA273	126	2SA351A	126
2SA71BS	126	2SA123	126	2SA205	100	2SA274	126	2SA351B	126
2SA71Y	126	2SA124	126	2SA206	100	2SA275	126	2SA352	126
2SA72	126	2SA125	126	2SA207	100	2SA276	126	2SA352A	126
2SA72BRN	126	2SA126	126	2SA208	100	2SA277	100	2SA352B	126
2SA72ORN	126	2SA127	126	2SA209	100	2SA278	100	2SA353	126
2SA72BLU	126	2SA128	126	2SA210	100	2SA279	100	2SA353A	126
2SA72WHT	126	2SA129	126	2SA211	100	2SA280	100	2SA353C	126
2SA72BLU-BLU	126	2SA130	100	2SA212	100	2SA281	100	2SA354	126
2SA73	126	2SA131	100	2SA213	126	2SA282	100	2SA354B	126
2SA74	100	2SA132	100	2SA214	126	2SA283	100	2SA355	126
2SA75	100	2SA133	100	2SA215	126	2SA284	100	2SA356	126
2SA76	126	2SA134	126	2SA216	126	2SA285	126	2SA357	126
2SA77	126	2SA135	100	2SA217	100	2SA286	126	2SA358	126
2SA77A	126	2SA136	126	2SA218	100	2SA287	100	2SA359	126
2SA77B	126	2SA137	100	2SA219	126	2SA288	126	2SA360	126



TRANSISTORS (cont'd)

Type To Be Replaced	Sylvania ECG Replacement	Type To Be Replaced	Sylvania ECG Replacement	Type To Be Replaced	Sylvania ECG Replacement	Type To Be Replaced	Sylvania ECG Replacement	Type To Be Replaced	Sylvania ECG Replacement
2SA361	126	2SA463	126	2SB42	104	2SB121	102	2SB175A	102
2SA362	100	2SA464	126	2SB43	102	2SB122	121	2SB175B	102
2SA364	126	2SA466	126	2SB43A	102	2SB123	104	2SB176	102
2SA365	126	2SA466BLK	126	2SB44	102	2SB123A	104	2SB176PR	102
2SA367	126	2SA466YEL	126	2SB46	102	2SB124	121	2SB176PRC	102
2SA368	126	2SA466BLU	126	2SB47	102	2SB126	127	2SB177	102
2SA369	126	2SA466-2	126	2SB48	102	2SB126F	127	2SB178	102
2SA372	126	2SA466-3	126	2SB49	102	2SB126V	127	2SB178A	102
2SA373	126	2SA468	126	2SB50	102	2SB127	104	2SB178M	102
2SA375	100	2SA469	126	2SB51	102	2SB128	127	2SB178T	102
2SA376	126	2SA470	126	2SB52	102	2SB128V	127	2SB180	104
2SA377	126	2SA471	126	2SB53	102	2SB129	121	2SB181	104
2SA378	126	2SA471-1	126	2SB54	102	2SB130	131	2SB181A	104
2SA379	126	2SA471-2	126	2SB54B	126	2SB130A	131	2SB183	102
2SA380	126	2SA471-3	126	2SB55	102	2SB131	104	2SB184	102
2SA381	126	2SA472	126	2SB56	102	2SB132	104	2SB185	102
2SA382	126	2SA472A	126	2SB56A	102	2SB134	100	2SB186	102
2SA383	126	2SA472B	126	2SB57	102	2SB135	102	2SB186A	102
2SA384	126	2SA472C	126	2SB59	102	2SB135A	102	2SB186AG	102
2SA385	126	2SA472D	126	2SB60	102	2SB135B	102	2SB186B	102
2SA385A	126	2SA472E	126	2SB60A	102	2SB135C	102	2SB186BY	102
2SA385L	126	2SA474	102	2SB61	102	2SB136	102	2SB186G	102
2SA391	126	2SA476	126	2SB62	104	2SB136B	102	2SB186Y	102
2SA392	126	2SA477	126	2SB63	131	2SB136C	102	2SB187	102
2SA393	126	2SA478	126	2SB64	104	2SB137	121	2SB187AA	102
2SA393A	126	2SA479	126	2SB65	102	2SB138	121	2SB187B	102
2SA394	126	2SA499	129	2SB66	100	2SB140	104	2SB187C	102
2SA395	126	2SA500	129	2SB67	102	2SB141	104	2SB187G	102
2SA396	102	2SA517	126	2SB67A	102	2SB142	104	2SB187R	102
2SA397	102	2SA518	126	2SB68	102	2SB142B	100	2SB188	102
2SA398	126	2SA522	129	2SB69	127	2SB142C	100	2SB189	102
2SA399	126	2SA522A	129	2SB71	102	2SB143	104	2SB199	102
2SA400	126	2SA525	126	2SB72	102	2SB143P	104	2SB200	102
2SA401	100	2SA525A	126	2SB73	102	2SB144	104	2SB200A	102
2SA403	126	2SA525B	126	2SB74	102	2SB144P	104	2SB201	126
2SA404	126	2SA530H	129	2SB75	102	2SB145	104	2SB202	102
2SA405	126	2SA539	129	2SB75A	102	2SB146	104	2SB203AA	102
2SA406	100	2SA564	128	2SB75B	102	2SB147	104	2SB215	127
2SA407	100	2SA564A	128	2SB75C	102	2SB149	104	2SB216	127
2SA408	126	2SB16A	105	2SB76	102	2SB150	102	2SB216A	127
2SA409	126	2SB17A	105	2SB77	102	2SB151	104	2SB217	121
2SA410	126	2SB18A	105	2SB77A	102	2SB152	104	2SB217A	121
2SA411	126	2SB19	104	2SB77A/P	102	2SB153	102	2SB217G	121
2SA412	126	2SB20	104	2SB77B	102	2SB154	102	2SB217U	121
2SA413	126	2SB21	104	2SB77C	102	2SB155	102	2SB218	102
2SA414	100	2SB22	102	2SB78	102	2SB155A	102	2SB219	102
2SA415	100	2SB22A	102	2SB80	121	2SB156	100	2SB220	102
2SA416	127	2SB22B	100	2SB81	121	2SB156A	102	2SB220A	102
2SA417	126	2SB23	102	2SB82	102	2SB156B	102	2SB221	102
2SA419	126	2SB24	102	2SB83	104	2SB156C	100	2SB221A	102
2SA420	126	2SB25	104	2SB84	121	2SB157	102	2SB222	102
2SA421	126	2SB25B	126	2SB85	102	2SB158	102	2SB223	102
2SA422	126	2SB26	104	2SB87	102	2SB159	102	2SB224	102
2SA425	100	2SB26A	104	2SB89	102	2SB160	102	2SB225	102
2SA426	100	2SB27	104	2SB89A	102	2SB161	102	2SB226	102
2SA427	126	2SB28	104	2SB90	102	2SB162	102	2SB227	102
2SA428	126	2SB29	104	2SB91	102	2SB163	102	2SB228	104
2SA431	126	2SB30	104	2SB92	102	2SB164	102	2SB229	121
2SA432	126	2SB31	104	2SB94	102	2SB165	102	2SB230	104
2SA433	126	2SB32	102	2SB95	102	2SB166	102	2SB231	127
2SA434	126	2SB32-0	102	2SB97	102	2SB167	102	2SB232	127
2SA435	126	2SB32-1	102	2SB98	102	2SB168	102	2SB233	104
2SA435A	126	2SB32-2	102	2SB99	102	2SB169	102	2SB235	105
2SA435B	126	2SB32-4	102	2SB100	102	2SB170	102	2SB236	105
2SA436	126	2SB33	102	2SB101	102	2SB171	102	2SB237	105
2SA437	126	2SB33C	102	2SB102	102	2SB171B	102	2SB237-12A	105
2SA438	126	2SB33D	102	2SB103	100	2SB172	102	2SB237-12B	105
2SA440	126	2SB33E	102	2SB104	100	2SB172A	102	2SB238-12A	105
2SA440A	126	2SB33F	102	2SB107	102	2SB172AF	102	2SB238-12B	105
2SA446	126	2SB33-4	102	2SB107A	121	2SB172B	102	2SB238-12C	105
2SA447	126	2SB34	102	2SB108	100	2SB172D	102	2SB239	121
2SA448	126	2SB37	102	2SB110	102	2SB172E	102	2SB239A	121
2SA453	126	2SB37A	102	2SB111	102	2SB172F	102	2SB240	102
2SA454	126	2SB37B	102	2SB112	102	2SB172P	102	2SB240A	102
2SA455	126	2SB37C	102	2SB113	102	2SB172R	102	2SB241	102
2SA456	126	2SB37F	102	2SB114	102	2SB173	102	2SB246	104
2SA457	126	2SB38	102	2SB115	102	2SB173A	102	2SB247	121
2SA460	126	2SB39	102	2SB116	102	2SB173B	102	2SB248	121
2SA461	126	2SB40	102	2SB117	102	2SB174	102	2SB248A	121
2SA462	126	2SB41	104	2SB120	102	2SB175	102	2SB249	104

## TRANSISTORS (cont'd)

Type To Be Replaced	Sylvania ECG Replacement	Type To Be Replaced	Sylvania ECG Replacement	Type To Be Replaced	Sylvania ECG Replacement	Type To Be Replaced	Sylvania ECG Replacement	Type To Be Replaced	Sylvania ECG Replacement
2SB249A	104	2SB329	102	2SB416	100	2SC41	130	2SC156	108
2SB250	104	2SB331	105	2SB417	100	2SC45	108	2SC157	123
2SB250A	104	2SB332	105	2SB422	102	2SC46	128	2SC158	123
2SB251	127	2SB333	105	2SB423	102	2SC47	123	2SC159	108
2SB251A	127	2SB334	105	2SB424	121	2SC48	123	2SC160	108
2SB252	127	2SB335	102	2SB425	121	2SC49	123	2SC163	128
2SB252A	127	2SB336	102	2SB426	121	2SC50	101	2SC166	108
2SB253	127	2SB337	121	2SB426Y	121	2SC50A	101	2SC170	128
2SB253A	127	2SB337B	121	2SB427	100	2SC52	123	2SC171	128
2SB254	131	2SB338	121	2SB428	100	2SC53	123	2SC172	108
2SB255	131	2SB339	121	2SB431	102	2SC54	108	2SC172A	108
2SB256	131	2SB340	121	2SB432	127	2SC55	108	2SC173	101
2SB257	102	2SB341	127	2SB439	102	2S56	123	2SC174	123
2SB258	105	2SB341V	127	2SB439A	102	2SC58A	128	2SC174A	123
2SB259	105	2SB342	127	2SB440	102	2SC60	101	2SC175	101
2SB260	105	2SB343	127	2SB443	102	2SC61	123	2SC176	101
2SB261	102	2SB345	100	2SB443B	102	2SC62	108	2SC177	101
2SB262	102	2SB346	100	2SB445	131	2SC64	123	2SC178	101
2SB263	102	2SB347	102	2SB446	102	2SC64	124	2SC179	101
2SB264	102	2SB348	100	2SB447	127	2SC68	124	2SC180	101
2SB265	102	2SB349	126	2SB448	127	2SC71	101	2SC181	101
2SB266	102	2SB350	102	2SB449	104	2SC72	101	2SC182	123
2SB266P	102	2SB351	105	2SB450	102	2SC73	101	2SC183	108
2SB266Q	102	2SB352	105	2SB450A	102	2SC74	108	2SC183E	108
2SB267	102	2SB353	105	2SB452	102	2SC75	101	2SC183J	108
2SB268	102	2SB354	105	2SB457	102	2SC76	101	2SC183K	108
2SB269	102	2SB355	104	2SB457A	102	2SC77	101	2SC183L	108
2SB270	102	2SB356	104	2SB458A	104	2SC77C	102	2SC183M	108
2SB270B	102	2SB358	127	2SB459	102	2SC78	101	2SC183P	108
2SB270C	102	2SB359	127	2SB463	131	2SC79	108	2SC183Q	108
2SB270D	102	2SB360	127	2SB463Y	131	2SC80	108	2SC184	108
2SB270E	102	2SB361	127	2SB464	127	2SC81	123	2SC184H	108
2SB271	100	2SB362	127	2SB465	127	2SC87	123	2SC184J	108
2SB272	100	2SB364	102	2SB466	131	2SC88A	101	2SC184L	108
2SB273	100	2SB365	102	2SB467	131	2SC89	108	2SC184M	108
2SB274	127	2SB367	131	2SB468	127	2SC90	101	2SC185J	108
2SB275	127	2SB367H	131	2SB468A	127	2SC91	101	2SC185M	108
2SB276	127	2SB368	131	2SB468B	127	2SC97	123	2SC185R	108
2SB282	102	2SB368A	131	2SB468C	127	2SC98	108	2SC185V	108
2SB283	121	2SB370	102	2SB470	102	2SC99	108	2SC186	128
2SB284	121	2SB370A	102	2SB471	121	2SC100	123	2SC187	108
2SB285	121	2SB371	100	2SB471-2	121	2SC101	124	2SC188	123
2SB290	126	2SB373	102	2SB471B	121	2SC101A	124	2SC188A	108
2SB291	100	2SB375	127	2SB472	121	2SC102	105	2SC188AB	108
2SB292	100	2SB376	126	2SB473	131	2SC103	128	2SC189	123
2SB292A	100	2SB377	126	2SB474	131	2SC103A	128	2SC190	123
2SB293	102	2SB378	126	2SB475	102	2SC104	128	2SC191	123
2SB294	100	2SB379	102	2SB475B	102	2SC104A	128	2SC192	123
2SB295	121	2SB379-2	102	2SB475F	102	2SC105	128	2SC193	123
2SB296	127	2SB380	102	2SB481	131	2SC108	123	2SC194	123
2SB299	100	2SB380A	102	2SB486	102	2SC109	123	2SC195	123
2SB300	127	2SB381	102	2SB482	102	2SC115	128	2SC196	123
2SB301	127	2SB382	102	2SB486	102	2SC116	128	2SC197	123
2SB302	102	2SB383	102	2SB497	102	2SC116T	128	2SC199	108
2SB303	102	2SB383-1	102	2SC11	101	2SC117	128	2SC200	123
2SB303A	102	2SB383-2	102	2SC12	128	2SC118	128	2SC201	123
2SB303B	102	2SB384	126	2SC13	101	2SC119	128	2SC202	123
2SB304	100	2SB385	126	2SC14	101	2SC120	128	2SC203	128
2SB304A	100	2SB387	100	2SC15	106	2SC121	128	2SC204	128
2SB309	127	2SB389	126	2SC16	128	2SC122	128	2SC205	128
2SB310	127	2SB390	127	2SC16A	128	2SC123	128	2SC206	128
2SB311	127	2SB391	127	2SC17	108	2SC124	128	2SC208	128
2SB312	127	2SB392	100	2SC17A	108	2SC125	100	2SC210	123
2SB314	100	2SB393	100	2SC18	128	2SC127	108	2SC211	123
2SB315	100	2SB394	100	2SC19	128	2SC128	101	2SC214	123
2SB316	100	2SB395	100	2SC27	128	2SC129	101	2SC216	123
2SB317	102	2SB396	100	2SC28	123	2SC131	128	2SC217	123
2SB318	127	2SB400	126	2SC29	123	2SC132	128	2SC218	123
2SB319	127	2SB401	100	2SC30	100	2SC133	128	2SC220	123
2SB320	127	2SB402	100	2SC31	123	2SC134	128	2SC221	123
2SB321	102	2SB403	100	2SC32	108	2SC135	128	2SC222	123
2SB322	102	2SB405	102	2SC33	108	2SC136	128	2SC225	108
2SB323	100	2SB405A	102	2SC34	101	2SC137	128	2SC226	123
2SB324	102	2SB405B	102	2SC35	102	2SC138	123	2SC227	123
2SB324A	102	2SB405C	102	2SC36	101	2SC138A	123	2SC228	123
2SB324B	102	2SB407	104	2SC37	108	2SC139	123	2SC229	123
2SB324N	102	2SB408	100	2SC38	108	2SC150	108	2SC230	108
2SB326	102	2SB413	104	2SC39	108	2SC150T	128	2SC231	123
2SB327	102	2SB414	104	2SC39A	108	2SC151	108	2SC232	123
2SB328	102	2SB415	102	2SC40	108	2SC155	108	2SC233	123

## TRANSISTORS (cont'd)

Type To Be Replaced	Sylvania ECG Replacement	Type To Be Replaced	Sylvania ECG Replacement	Type To Be Replaced	Sylvania ECG Replacement	Type To Be Replaced	Sylvania ECG Replacement	Type To Be Replaced	Sylvania ECG Replacement
2SC237	128	2SC394	108	2SC544	108	2SC772	108	2SD96	101
2SC238	128	2SC398	108	2SC545	108	2SC772C	108	2SD100	101
2SC239	128	2SC399	108	2SC545A	108	2SC772D	108	2SD100A	101
2SC241	130	2SC400	108	2SC545B	108	2SC772E	108	2SD101	101
2SC248	123	2SC401	123	2SC545C	108	2SC772K	108	2SD104	101
2SC249	123	2SC402	123	2SC545D	108	2SC772R	108	2SD105	101
2SC250	108	2SC403	128	2SC545E	108	2SC784	108	2SD120	128
2SC251	108	2SC403A	128	2SC558	130	2SC828	123	2SD121	128
2SC251A	108	2SC404	128	2SC561	108	2SC828A	123	2SD124	130
2SC252	108	2SC405	108	2SC562	108	2SC828Q	123	2SD124AH	130
2SC253	108	2SC406	108	2SC563	128	2SC829	108	2SD125	130
2SC263	108	2SC423F	123	2SC563A	128	2SC839	108	2SD125AH	130
2SC266	108	2SC429	108	2SC568	108	2SC840	124	2SD127	101
2SC267	108	2SC429J	108	2SC580	128	2SC856C	128	2SD127A	101
2SC268	108	2SC430	108	2SC582	124	2SCF1	108	2SD128	101
2SC268A	108	2SC430H	108	2SC594	123	2SCF5	128	2SD128A	103
2SC269	108	2SC440	123	2SC595	123	2SCF6	128	2SD134	123
2SC271	108	2SC441	123	2SC596	123	2SCF13E	123	2SD136	124
2SC272	108	2SC442	123	2SC601	108	2SCS184E	123	2SD137	124
2SC281	123	2SC443	128	2SC602	108	2SCS184J	108	2SD141	130
2SC281B	123	2SC454	128	2SC605	108	2SCS429J	108	2SD142	152
2SC281C	123	2SC454A	128	2SC606	108	2SCS430H	108	2SD143	152
2SC282	108	2SC454B	128	2SC608	128	2SCS461F	108	2SD146	130
2SC283	108	2SC454C	128	2SC608T	128	2SCS469F	108	2SD147	130
2SC284	108	2SC454LA	128	2SC609	128	2SD11	103	2SD150	130
2SC285	108	2SC455	128	2SC609T	128	2SD12	130	2SD151	130
2SC285A	108	2SC458	123	2SC611	108	2SD15	130	2SD157	124
2SC286	108	2SC458A	123	2SC612	108	2SD16	103	2SD158	124
2SC287	108	2SC458B	123	2SC621	128	2SD19	103	2SD159	124
2SC288	108	2SC458C	123	2SC622	128	2SD20	103	2SD161	101
2SC288A	108	2SC459	128	2SC629	128	2SD21	103	2SD162	101
2SC289	108	2SC460	128	2SC631	123	2SD22	103	2SD167	101
2SC291	128	2SC460A	128	2SC632	123	2SD23	103	2SD172	130
2SC292	128	2SC460B	128	2SC633	123	2SD24	124	2SD174	130
2SC293	128	2SC460C	128	2SC633-7	123	2SD25	103	2SD175	130
2SC299	123	2SC460D	128	2SC645	128	2SD26A	130	2SD178	102
2SC300	108	2SC461	128	2SC645A	128	2SD26B	130	2SD178A	102
2SC301	108	2SC461B	128	2SC650	123	2SD26C	130	2SD180	130
2SC302	108	2SC463	108	2SC650B	123	2SD28	152	2SD186	101
2SC306	123	2SC464	108	2SC657	128	2SD29	152	2SD187	101
2SC307	128	2SC464C	108	2SC658	128	2SD30	101	2SD187A	101
2SC313	108	2SC465	108	2SC658A	128	2SD31	101	2SD190	124
2SC316	108	2SC466	108	2SC659	108	2SD32	101	2SD191	101
2SC317C	123	2SC469	108	2SC662	108	2SD33	101	2SD192	101
2SC318	108	2SC469F	108	2SC668	108	2SD33C	101	2SD193	101
2SC319	123	2SC470	128	2SC668A	108	2SD34	101	2SD194	101
2SC320	123	2SC475	108	2SC668B	108	2SD36	101	2SD195	101
2SC323	123	2SC476	108	2SC668C	108	2SD37	101	2SD195A	101
2SC324	123	2SC477	108	2SC668D	108	2SD37A	101	2SE629	108
2SC324A	123	2SC478	128	2SC668E	108	2SD37B	101	2SE4002	101
2SC324H	123	2SC481	128	2SC682	108	2SD37C	101	2T11	102
2SC324HA	123	2SC482	128	2SC682A	108	2SD38	101	2T12	102
2SC352	108	2SC482Y	128	2SC683	108	2SD43	101	2T13	102
2SC356	124	2SC486	123	2SC684	108	2SD43A	101	2T14	102
2SC360	108	2SC486Y	123	2SC685	124	2SD44	101	2T14A	126
2SC361	108	2SC487	108	2SC685A	124	2SD49	152	2T15	102
2SC362	108	2SC490	152	2SC687	130	2SD50	130	2T16	102
2SC363	108	2SC494	130	2SC688	108	2SD51	130	2T17	102
2SC367	123	2SC503	123	2SC693	123	2SD53	130	2T20	102
2SC368	108	2SC504	123	2SC694	123	2SD56	152	2T21	102
2SC369	123	2SC513	128	2SC696	128	2SD61	103	2T22	102
2SC370	123	2SC514	124	2SC701	123	2SD62	103	2T23	102
2SC371	108	2SC515	124	2SC702	123	2SD63	103	2T24	102
2SC371B	108	2SC529	108	2SC708	128	2SD64	101	2T25	102
2SC372	123	2SC535	108	2SC708A	128	2SD65	103	2T26	102
2SC373	123	2SC535A	108	2SC709	108	2SD65-1	103	2T40	108
2SC374	108	2SC535B	108	2SC712	123	2SD66	103	2T41	108
2SC375	108	2SC535C	108	2SC715	123	2SD70	130	2T42	108
2SC376	108	2SC536	123	2SC717	108	2SD72	103	2T43	108
2SC379	128	2SC536D	123	2SC727	123	2SD72A	101	2T44	108
2SC380	108	2SC536F	123	2SC732	123	2SD72B	101	2T51	103
2SC381	108	2SC537	123	2SC733	123	2SD72C	101	2T52	101
2SC382	108	2SC537C	123	2SC735	123	2SD75	103	2T53	101
2SC382G	108	2SC537D	123	2SC735ORN	123	2SD75A	103	2T61	103
2SC382R	108	2SC537E	123	2SC735Y	123	2SD77	103	2T62	103
2SC384	108	2SC538	123	2SC738	108	2SD77A	103	2T63	103
2SC385	108	2SC538A	123	2SC739	108	2SD80	130	2T64	103
2SC386	108	2SC538Q	108	2SC762	108	2SD81	130	2T64R	103
2SC387	108	2SC539	123	2SC765	130	2SD82	130	2T65	103
2SC388	108	2SC540	108	2SC768	130	2SD91	124	2T65R	103

## TRANSISTORS (cont'd)

Type To Be Replaced	Sylvania ECG Replacement	Type To Be Replaced	Sylvania ECG Replacement	Type To Be Replaced	Sylvania ECG Replacement	Type To Be Replaced	Sylvania ECG Replacement	Type To Be Replaced	Sylvania ECG Replacement
2T66	103	2TN95	102	4JD3B1	101	6-70	126	11B555	108
2T66R	103	2TN95A	102	4JX1A520	102	6-71	126	11B1052	108
2T67	101	2V362	102	4JX1A520B	102	6-72	126	11B1055	108
2T69	103	2V363	102	4JX1A520C	102	6-88	102	11C3B1	124
2T71	101	2V464	100	4JX1A520D	100	6-89	126	11C551	108
2T72	101	2V465	100	4JX1A520E	100	6-89X	126	11C553	108
2T73	101	2V466	100	4JX1A813	101	6-90	123	11C557	108
2T73R	101	2V467	100	4JX1C850	102	6-93	123	11C1051	108
2T74	101	2V482	100	4JX1C850A	100	6D122	100	11C1053	108
2T75	101	2V483	100	4JX1E821	100	6D122R	100	11C1057	108
2T75R	101	2V484	100	4JX1E850	103	6D122V	100	11C1536	124
2T76	101	2V485	100	4JX2A60	100	6MC	126	11C1B1	128
2T76R	101	2V486	100	4JX2A601	103	7-4	108	11C3B3	124
2T77	101	2V559	126	4JX2A801	101	7-6	108	11C5B1	124
2T77R	101	2V560	126	4JX2A816	103	7-7	108	11C7B1	124
2T78	101	2V561	100	4JX2A822	103	7-8	108	11C10B1	124
2T78R	101	2V562	100	4JX80404	121	7A30	107	11C11B1	124
2T82	101	2V563	100	4JX8P404	121	7A31	107	12A6240	100
2T83	101	2V631	100	4JX8P409	121	7A32	107	12A9275	102
2T84	103	2V632	100	4JX16A527	108	7B1	124	12A9275-1	102
2T85	103	2V633	100	4JX16A667/G	107	7B2	124	12M2	121
2T85A	103	2-36	103	4JX16A667/O	107	7B13	124	12M C	126
2T86	103	3B15	102	4JX16A667/R	107	7C1	124	12M Z	126
2T89	103	3B15-1	102	4JX16A667/Y	107	7C2	124	12X047	108
2T201	126	3L4-6001-01	130	4JX16A668/G	107	7C3	124	13-0020	108
2T202	123	3MC	126	4JX16A668/O	107	7D1	124	13-1032-5	108
2T203	126	3N22	101	4JX16A668/Y	107	7D2	124	13-10321-5	108
2T204	126	3N23	101	4JX16A669/G	123	7D3	124	13-10321-6	108
2T204A	126	3N23A	101	4JX16A669/Y	107	7E1	124	13-10321-7	108
2T205	126	3N23B	101	4JX16A670/G	123	7E2	124	13-10321-8	108
2T205A	126	3N23C	101	4JX16B670/B	107	7E3	124	13-10321-10	108
2T230	102	3N29	101	4JX16B670/G	123	7G1	124	13-10321-11	108
2T231	102	3N30	101	4JX16B670/R	128	7G2	124	13-10321-12	108
2T311	102	3N31	101	4JX16B670/Y	128	7G3	124	13-10321-14	108
2T312	102	3N34	126	4JX2816	103	7G4	124	13-10321-15	108
2T313	102	3N35	128	4JX2825	103	8-0024-1	108	13-10321-16	108
2T314	102	3N35A	128	5-8	128	8-0024-2	108	13-10321-17	108
2T315	102	3N36	101	5RC10	122	8-0024-3	123	13-105698-1	128
2T321	102	3N37	101	5RC10G	122	8-0062	102	13-14604-1	121MP
2T322	102	3N49	105	5RC15	122	8-723-650	103	13-14735-1	121
2T323	102	3N50	105	5RC15A	122	8D	126	13-14735A	121
2T324	102	3N51	105	5RC20	122	8E	126	13-14735-1	121
2T383	102	3N52	105	5RC20A	122	8F	126	13-14778-1	121MP
2T402	123	3N71	107	5RC10	122	8H303	121	13-14886-1	126
2T403	108	3N72	107	5RCL15	122	8L	126	13-14887-1	126
2T404	108	3N73	107	5RCL20	122	8L201	121	13-14888-3	102
2T513	101	3N90	129	6-4	128	8L201B	121	13-14889-1	102
2T520	101	3N91	129	6-04	123	8L201R	121	13-15805-1	126
2T521	101	3N92	129	6-04ORN	128	8L201V	121	13-15808-1	123
2T522	103	3N93	129	6-04GRN	128	8L404	121	13-15808-2	123
2T523	103	3N94	129	6-04S1	128	8P	126	13-15809-1	128
2T524	101	3N95	129	6-04S2	128	8P40	104	13-15810-1	108
2T551	101	3N112	106	6-05	123	8P40A	104	13-15833-1	128
2T552	103	3N113	106	6-05YEL	128	8P404F	104	13-15835-1	108
2T650	101	3RC10	122	6-05F	128	8P404R	121	13-15836-1	102
2T681	103	3RC10A	122	6-11	128	8P404ORN	104	13-15840-1	128
2T682	103	3RC15	122	6-13	128	8P404T	121	13-15840-2	108
2T918	108	3RC20	122	6-19	128	8P404V	121	13-15841-1	128
2T919	107	3RC20A	122	6-30	128	8P416C	121	13-15842-1	103
2T2001	102	3S004	123	6-31	102	8A	126	13-16570-1	106
2T2708	108	3T201	101	6-53	102	10B	126	13-16592-1	127
2T2857	108	3T202	101	6-53/63	102	10B551	108	13-16607-1	127
2T3011	104	3T203	101	6-53A	102	10B553	108	13-16608-1	127
2T3021	104	3TE120	130	6-60	126	10B555	108	13-17607B	127
2T3022	104	3TE230	130	6-60B	126	10B556	108	13-17607-1	127
2T3030	104	3TE240	130	6-60D	126	10H1051	108	13-17608B	127
2T3031	104	3TX003	130	6-60P	126	10H1055	108	13-17608C	127
2T3032	104	3TX004	130	6-61	126	10C	126	13-17608-1	127
2T3033	104	4C28	123	6-61B	126	10CS73	108	13-17608-2	127
2T3041	104	4C29	123	6-61D	126	10CS74	108	13-17609-1	127
2T3042	104	4C30	123	6-61P	126	10G1051	108	13-18034	121
2T3043	104	4C31	123	6-62	126	10G1052	108	13-18034A	121
2TN15	100	4D20	123	6-62A	126	10H551	108	13-18034-1	121
2TN32	100	4D21	123	6-62B	126	10H553	108	13-18087-1	123
2TN45A	102	4D22	123	6-62D	126	10H1051	108	13-18087-2	123
2TN48	100	4D24	123	6-62P	126	10H1053	108	13-18158-1	123
2TN49	100	4D25	123	6-63	102	10P1	129	13-18198-1	121MP
2TN52	100	4D26	123	6-63A	102	11B551	108	13-18282	124
2TN53	100	4JD1A17	102	6-69	126	11B552	108	13-18282-1	124
2TN56	102	4JD1A73	102	6-69X	126	11B554	108	13-18304-1	102

TRANSISTORS (cont'd)

Type To Be Replaced	Sylvania ECC Replacement	Type To Be Replaced	Sylvania ECC Replacement	Type To Be Replaced	Sylvania ECC Replacement	Type To Be Replaced	Sylvania ECC Replacement	Type To Be Replaced	Sylvania ECC Replacement
13-1836-1	124	14-602-32	129	21-37	102	27T410	103	34-6000-77	126
13-18359	124	14-602-34	108	21A005-000	102	27T411	123	34-6000-78	126
13-18359A	124	14-602-35	123	21A015-001	102	27T412	126	34-6000-79	126
13-18359-1	124	14-603-02	108	21A015-004	108	29A4	129	34-6000-80	126
13-18363	123	14-603-03	108	21A015-005	103	29V008M01	100	34-6000-81	126
13-18363-1	123	14-604-02	121	21A015-006	102	29V011H01	100	34-6000-82	126
13-18363-1A	123	14-2002-1	121MP	21A015-013	123	29V012H01	100	34-6000-83	100
13-18364-1	123	15-2	128	21A038-000	102	29V0038H03	102	34-6000-84	126
13-18365-1	123	15-4	106	21A048-000	126	30-004-001	121	34-6000-85	126
13-18642	121	15-5	129	21A049-000	126	30-090	152	34-6001-16	102
13-18642-1	121MP	15Z3	129	21A050-000	126	30V-H6	102	34-6001-28	102
13-18654-1	103	16-736	108	21A050-001	126	31-0015	126	34-6001-33	102
13-18927-1	128	16-21426	108	21A053-000	102	31-0016	126	34-6001-43	100
13-18927-1A	128	16A1	103	21A054-000	102	31-0017	102	34-6001-44	100
13-18944-1	102	16A2	103	21A055-000	102	31-0018	102	34-6001-50	123
13-18946-1	126	16G2	108	21A062-000	126	31-0035	102	34-6001-52	128
13-18947-1	126	16J1	108	21A064-000	121	31-0041	126	34-6001-53	123
13-18948-1	126	16J2	108	21A074-000	102	31-0042	126	34-6001-54	123
13-18948-2	126	16K1	108	21A097-000	121	31-0107	102	34-6001-55	123
13-18950-1	108	16K2	108	23	128	31-0108	126	34-6001-56	123
13-18951-1	126	16K3	108	23-1	129	31-0123	126	34-6001-57	123
13-18951-2	126	16L2	108	23-2	129	31-0124	126	34-6001-58	128
13-21606-1	127	16L3	108	23-3	129	31-0132	126	34-6001-60	123
13-22581	123	16L5	108	23B-210-025	121	31-0134	126	34-6001-61	128
13-22581-1	128	16L22	108	23B-210-230-2	127	31-0135	126	34-6001-62	128
13-22582-1	129	16L23	108	24A	129	31-0139	126	34-6001-63	123
13-22692-1	132	16L42	106	24-002	108	31-0141	126	34-6001-64	123
13-22739-1	121MP	16L43	108	24B	108	31-0150	126	34-6001-65	123
13-22741	121	16L44	108	24M W15	102	31-0153	102	34-6001-66	102
13-22741-1	121MP	16L62	108	24M W27	126	31-0161	102	34-6001-69	123
13-23543-1	124	16L63	108	24M W28	102	31-0168	126	34-6001-70	123
13-23594-1	128	16L64	108	24M W29	102	31-0170	126	34-6001-71	102
13-23785-1	102	16P3367	128	24M W34	126	31-0171	126	34-6001-72	123
13-23822-1	108	16K1	108	24M W43	102	31-0172	102	34-6001-73	123
13-23824-1	108	16K2	108	24M W44	126	31-0175	127	34-6001-74	128
13-23825-1	123	17A4422-1	121	24M W55	126	31-0177	123	34-6001-76	102
13-23826-1	106	19-020-031	126	24M W59	126	31-0178	126	34-6001-77	123
13-23826-2	106	19-020-032	126	24M W60	102	31-0180	126	34-6002-17	104
13-23840-1	128	19-020-033	100	24M W61	126	31-0184	126	34-6002-18	104
13-23916-1	128	19-020-034	102	24M W69	102	31-0187	123	34-6002-18A	104
13-25343-1	124	19-020-035	102	24M W70	102	31-0188	102	34-6002-19	104
13-26009-1	108	19-020-036	102	24M W74	126	31-0190	126	34-6002-20	104
13-26386-1	106	19-020-037	108	24M W77	100	31-0191	126	34-6002-21	124
13-26576-1	108	19-020-048	108	24M W78	102	31-0192	121	34-6002-22	104
13-26576-2	108	19-020-44	108	24M W83	102	31-0196	127	34-6002-22A	104
13-26577-1	108	19-1	129	24M W84	102	31-0205	102	34-6002-26	124
13-26577-3	108	19A115129-2	103	24M W107	102	31-0217	126	34-6008	102
13-26666-1	128	19A115180-2	129	24M W111	126	31-025	102	34-6009	102
13-27404-1	123	19A115249-1	108	24M W115	102	31-0228	126	34-6015-1	108
13-27443-1	128	19A115300-1	128	24M W116	102	31-0229	102	34-6015-2	123
13-86416-1	103	19A115300-2	128	24M W130	103	31-0239	123	34-6015-3	108
13-94096-2	102	19A115304-2	128	24M W132	102	31-0240	131MP	34-6015-4	108
14-3	128	19A115342-1	108	24M W205	126	31-0241	121	34-6015-5	108
14-573-10	105	19A115440-1	108	24M W263	102	31-0241-1	121	34-6015-6	108
14-574-10	121	19A115441-1	108	24M W271	126	32-16599	121MP	34-6015-7	108
14-575-10	103	19A115527	152	24M W303	126	32-20738	123	34-6015-8	108
14-577-10	102	19A115561	121	24M W352	126	32-20739	129	34-6015-9	108
14-578-10	104	19A115666-1	108	24M W353	126	33-071	123	34-6015-10	108
14-581-01	126	19A115720-1	123	24M W458	123	33-090	152	34-6015-11	108
14-583-01	103	19A115728-1	123	24T-002	108	33-096	153	34-6015-13	123
14-600-01	126	19A115786	123	24T-016	108	34-6	126	34-6015-14	123
14-600-02	126	19A115786A	123	24T-016-001	108	34-119	126	34-6016-11	102
14-600-04	126	19A123160-1	108	24T-016-005	108	34-220	126	34-6016-14	123
14-600-10	126	19A126813	130	24T-016-013	108	34-221	126	34-6016-17	123
14-600-16	126	19-3415	102	25-100015	108	34-298	126	34-8001-43	126
14-600-19	126	19-3416	102	25A	108	34-1000	130	35P1	102
14-601-01	105	20A0007	102	25A M624	108	34-1002	152	35P2	102
14-601-03	104	20A0009	102	25B	108	34-1003	153	35P2C	102
14-601-05	121	20A0015	102	25B378	100	34-6000-3	100	35T1	102
14-601-06	104	20A0017	121	25T1	102	34-6000-10	126	36P1	102
14-601-08	121	20C71	102	26T1	102	34-6000-16	126	36P1C	102
14-602-01	123	20C72	102	27T401	100	34-6000-18	100	36P1F	102
14-602-02	128	20M C	126	27T402	100	34-6000-19	100	36P2F	102
14-602-03	123	20V-HG	102	27T403	102	34-6000-62	126	36P3	102
14-602-05	102	21-28	121	27T404	102	34-6000-64	108	36P3A	102
14-602-05A	102	21-32	126	27T405	102	34-6000-69	108	36P3C	102
14-602-13	123	21-33	126	27T406	121	34-6000-70	108	36P4	102
14-602-29	123	21-34	102	27T407	105	34-6000-71	108	36P4C	102
14-602-30	123	21-35	124	27T408	101	34-6000-72	108	36P5	102
14-602-31	108	21-36	102	27T409	123	34-6000-76	126	36P5C	102

## TRANSISTORS (cont'd)

Type To Be Replaced	Sylvania ECG Replacement	Type To Be Replaced	Sylvania ECG Replacement	Type To Be Replaced	Sylvania ECG Replacement	Type To Be Replaced	Sylvania ECG Replacement	Type To Be Replaced	Sylvania ECG Replacement
36P7	102	43P4C	102	48R869475	102	48S134941	123	57A21-5	108
36P7C	102	43P6	102	48R869475A	102	48S134942	128	57B2-3	102
36P8C	102	43P6A	102	48R869476	103	48S134943	128	57D2-7	102
36T1	102	43P6C	100	48R869476A	103	48S134945	108	57B2-8	103
37T1	126	43P7	102	48S10079A02	126	48S134946	108	57B2-11	126
38T1	102	43P7A	102	48S134405	123	48S134947	121	57B2-13	126
38P1	102	43P7C	102	48S134407	102	48S134948	108	57B2-14	126
39A9	102	43X16A567	123	48S134408	102	48S134949	108	57B2-15	102
39P1	121	44-13	126	48S134656	123	48S134950	108	57B2-19	126
39P1C	121	44A354637-001	152	48S134695	126	48S134956	126	57B2-22	126
39T1	102	44P1	126	48S134718	123	48S134960	108	57B2-23	100
40D1547	126	45N1	103	48S134719	123	48S134970	108	57B2-25	102
40P1	102	45N2	103	48S134720	123	48S134972	124	57B4-2	121
40P2	102	45N2M	123	48S134732	123	48S134979	108	57B4-4	121
41B581014	128	45N3	128	48S134733	123	48S134981	108	57B6	102
41N1	108	45N4	123	48S134733A	123	48S134992	128	57B21	108
41N2	108	45NP	108	48S134734	123	48S137007	123	57B21-2	108
41N2B	108	45X1A502C	102	48S134734A	123	48S65123A67	108	57B21-4	108
41N3	108	45X2	100	48S134737	123	48SP134804	123	57B21-5	108
42-16599	121	46-8682-3	123	48S134739	124	48SP134826	108	57B21-6	108
42-17143	102	46-86143-3	123	48S134739A	124	48SP134837	108	57B21-7	108
42-17444	123	47P1	121	48S134747	121	48SP134855	123	57B101-4	108
42-18109	102	47-2	108	48S134759	121	48SP134857	108	57B102-4	108
42-18111	123	48-21598B01	128	48S134761	121	48SP134894	123	57B103-4	108
42-18310	124	48A124315	102	48S134765	123	48SP134897	123	57B104-8	128
42-19642	128	48A134434	126	48S134766	121	48SP134903	123	57B105-12	128
42-19643	129	48C124246	121	48S134767	121	48SP134904	108	57B106-12	129
42-19644	123	48C125237	102	48S134768	123	48SP134905	123	57B107-8	128
42-19670	123	48K35P1	102	48S134773	108	48SP134906	123	57B108-6	129
42-19671	102	48K36P1	102	48S134774	108	48SP134933	123	57B109-9	129
42-19682	100	48K36P3	102	48S134775	108	48SP134937	108	57B110-9	128
42-19683	108	48K39P1	121	48S134776	108	48X134970	108	57B122-9	129
42-19792	126	48K39P3	102	48S134783	108	49P1C	121	57B129-9	128
42-19840	123	48K43P3	102	48S134784	108	50P2	126	57B130-9	128
42-19862	103	48K43P4	102	48S134785	108	50P3	126	57B131-10	128
42-19862A	102	48K56P1	100	48S134797	108	51	128	57B132-10	129
42-19863	102	48K57B2	121	48S134804	108	51D170	102	57B136-12	128
42-19863A	102	48K57B42	121	48S134805	108	51D188	100	57B137-12	129
42-19864	102	48K125230	104	48S134807	108	51D189	100	57B141-4	108
42-19864A	102	48K134458	102	48S134809	123	51P2	126	57B142-4	108
42-20738	123	48K134494	126	48S134810	123	51P4	126	57B143-12	128
42-20739	129	48K134495	126	48S134811	123	53P151	123	57B144-12	128
42-20961	152	48K134496	126	48S134820	108	53P153	121	57B145-12	129
42-20961	130	48K134601	126	48S134825	108	53P157	102	57B146-12	123
42-21401	108	48K134796	126	48S134826	108	53P158	123	57B147-12	129
42-21402	108	48K134798	126	48S134827	108	53P159	123	57B148-12	129
42-21403	100	48K869001	100	48S134832	108	53P162	123	57B149-12	132
42-21404	102	48K86904GF	126	48S134837	108	53P166	123	57B151-6	108
42-21405	103	48K869228	128	48S134838	123	53P163	123	57B152-12	108
42-21406	102	48P1	102	48S134840	108	53P165	123	57B153-9	123
42-21407	123	48P63005A72	123	48S134841	108	53P166	129	57B155-10	124
42-21443	121MP	48P65112A65	108	48S134842	123	53P169	128	57B156-9	123
42-22008	129	48P65113A88	108	48S134843	123	53P170	129	57B157-9	129
42-22158	128	48P65118A64	108	48S134844	123	54	128	57B159-12	129
42-22778	126	48P65123A67	108	48S134845	108	54A	123	57C5	103
42-22779	126	48P65123A95	108	48S134853	123	54B	123	57C5-1	126
42-22780	126	48P65144A72	108	48S134854	123	54C	123	57C5-2	126
42-22781	126	48P65146A61	108	48S134855	123	54D	123	57C5-3	126
42-22784	126	48P65146A62	108	48S134857	108	54E	123	57C5-4	126
42-22785	123	48P65146A63	108	48S134860	100	54BLK	128	57C5-5	126
42-22786	123	48R134407	102	48S134861	100	54BRN	128	57C5-6	108
42-22787	123	48R134573	102	48S134862	100	54RED	128	57C5-7	108
42-22809	123	48R134621	102	48S134872	130	54ORN	128	57C5-8	108
42-22810	129	48R134632	102	48S134879	108	54YEL	128	57C5-9	126
42-22811	123	48R134665	103	48S134894	108	54GRN	128	57C5-10	126
42-22812	123	48R134666	123	48S134898	123	54BLU	128	57C6-1	102
42-22834	121MP	48R134695	121	48S134899	123	54WHT	128	57C6-2	102
42X210	103	48R134722	121	48S134903	123	55P2	126	57C6-3	121
42-230	102	48R859428	128	48S134904	108	55P3	126	57C6-4	123
42X233	102	48R869138	128	48S134905	123	55-1016	102	57C6-5	103
42X308	102	48R869148	102	48S134906	123	55-1026	123	57C6-6	102
42X309	102	48R869170	128	48S134909	102	55-1027	123	57C6-6A	100
42X310	103	48R869248	123	48S134910	129	55-1029	102	57C6-6B	100
42X311	102	48R869249	102	48S134918	123	55-1031	102	57C6-6C	100
43N3	123	48R869253	102	48S134919	128	55-1032	123	57C6-7	123
43N6	123	48R869254	103	48S134920	124	55-1034	123	57C6-8	121
43P1	100	48R869282	102	48S134922	108	56P1	126	57C6-9	123
43P2	102	48R869283	103	48S134933	123	56P2	126	57C6-10	124
43P3	100	48R869426	129	48S134935	128	56P3	126	57C6-11	123
43P4	102	48R869464	128	48S134937	108	56P4	126	57C6-12	121

TRANSISTORS (cont'd)

Type To Be Replaced	Sylvania ECG Replacement	Type To Be Replaced	Sylvania ECG Replacement	Type To Be Replaced	Sylvania ECG Replacement	Type To Be Replaced	Sylvania ECG Replacement	Type To Be Replaced	Sylvania ECG Replacement
57C6-14	124	57D184	100	80P1	102	86-100-2	126	86-277-2	123
57C6-15	102	57D186	126	81T2	128	86-101-2	126	86-278-2	126
57C6-16	126	57D187	126	83P1B	129	86-102-2	126	86-279-2	126
57C6-17	123	57D188	102	83P2	123	86-108-2	126	86-280-2	126
57C6-19	123	57D189	102	83P2B	129	86-109-2	126	86-281-2	126
57C6-21	103	57D1127	102	83P3	129	86-110-2	123	86-282-2	126
57C6-22	102	57D1130	126	83P3B	129	86-111-2	126	86-283-2	126
57C6-23	121	57D1131	126	83P3M	129	86-112-2	125	86-284-2	123
57C6-24	124	57D1132	126	83-1056	121	86-114-2	102	86-291-2	123
57C6-27	123	57D1143	102	84	121	86-115-2	100	86-292-2	127
57C6-29	123	57D1186	126	84B	121	86-116-2	100	86-295-2	126
57C6-30	123	57P1	102	86A318	102	86-117-2	126	86-296-2	100
57C6-31	129	58B2-14	126	86-4-2	101	86-119-2	126	86-301-2	102
57C6-32	123	61C001-1	123	86-6-2	101	86-120-2	121	86-303-2	102
57C6-33	129	61C002-1	102	86-8-2	121	86-123-2	123	86-304-2	102
57C9-2	121	61C003-1	102	86-10-2	102	86-126-2	102	86-305-2	102
57C10-1	108	61C004-1	128	86-11-2	103	86-127-2	121	86-308-2	123
57C10-2	108	61C005-1	121	86-12-2	103	86-128-2	102	86-310-2	123
57C12-4	128	61P1	126	86-13-2	103	86-129-2	102	86-311-2	126
57C15-3	126	61P10	126	86-14-2	103	86-130-2	102	86-312-2	126
57C16	126	63P3	102	86-16-2	102	86-131-2	126	86-313-2	121MP
57C20-1	108	63-29459	121	86-18-2	126	86-132-2	100	86-317-2	121
57C23-1	129	64T1	100	86-19-2	121	86-133-2	100	86-319-2	121
57C23-2	129	65A	106	86-20-2	126	86-135-2	126	86-327-2	123
57C27-2	108	65B	106	86-21-2	100	86-136-2	126	86-328-2	123
57D1-11	102	65C	106	86-22-2	100	86-138-2	108	86-334-2	129
57D1-26	102	65D	106	86-23-2	102	86-139-2	123	86-336-2	128
57D1-27	102	65E	106	86-24-2	103	86-141-2	121	86-339-2	123
57D1-30	100	65F	106	86-25-2	103	86-142-2	128	86-340-2	129
57D1-31	100	65T1	100	86-26-2	101	86-143-2	123	86-342-2	123
57D1-32	100	66-6023-00	102	86-27-2	100	86-146-2	121	86-344-2	152
57D1-42	102	66-6024-00	102	86-28-2	100	86-147-2	121	86-345-2	153
57D1-43	102	66-6025-00	102	86-29-2	102	86-149-2	126	86-348-2	100
57D1-44	102	66-6026-00	102	86-30-2	102	86-150-2	126	86-367-2	126
57D1-56	102	66-6027-00	102	86-31-2	101	86-151-2	126	86-368-2	126
57D1-68	100	66-6028-00	102	86-32-2	100	86-155-2	123	86-370-2	121MP
57D1-69	100	67P1	121	86-33-2	100	86-156-2	102	86-373-2	126
57D1-70	102	67P2	121	86-35-2	103	86-156-2A	102	86-374-2	126
57D1-80	100	68P1	121	86-36-2	126	86-157-2	123	86-389-2	123
57D1-81	126	68P1B	121	86-37-2	126	86-158-2	123	86-390-2	123
57D1-84	100	69N1	108	86-38-2	126	86-159-2	102	86-391-2	123
57D1-86	100	70N1	123	86-39-2	102	86-161-2	128	86-396-2	153
57D1-87	100	70N2	123	86-42-1	123	86-162-2	126	86-399-2	123
57D1-88	126	71N1	124	86-44-2	101	86-163-2	126	86-403-2	123
57D1-89	100	71N2	124	86-45-2	102	86-164-2	126	86-512-2	105
57D1-96	126	72N1	108	86-46-2	100	86-169-2	102	86-1392	123
57D1-97	126	72N1B	128	86-47-2	100	86-170-2	128	86-5042-2	102
57D1-105	126	72N2	108	86-48-2	100	86-171-2	123	86-5043-2	121
57D1-107	126	72N2B	128	86-49-2	102	86-173-2	121	86-5067-2	100
57D1-111	102	73N1	108	86-50-2	102	86-175-2	123	86-5084-2	130
57D1-114	126	73N1B	128	86-58-2	103	86-177-2	124	86-5943-2	121
57D1-119	104	74	108	86-59-2	100	86-178-2	129	86X0006-001	128
57D1-120	102	74P1	100	86-60-2	100	86-179-2	126	86X0007-004	123
57D1-121	102	74N1	100	86-61-2	102	86-180-2	126	86X0008-001	123
57D1-123	123	75N1	123	86-62-2	121	86-181-2	126	86X0009-001	121
57D1-124	123	76	100	86-63-2	121	86-185-2	108	86X0011-001	126
57D3-6	102	76-13570-39	108	86-72-2	102	86-188-2	123	86X0012-001	123
57D4-1	121	76-13570-59	108	86-73-2	102	86-191-2	123	86X0013-001	126
57D5-1	126	76-13866-17	108	86-74-2	102	86-194-2	123	86X0014-001	100
57D5-2	126	76-13866-18	108	86-75-2	102	86-199-2	123	86X0015-001	121
57D5-4	126	76-13866-19	108	86-76-2	102	86-201-2	123	86X0017-001	102
57D6-10	124	76-13866-62	108	86-77-2	103	86-204-2	108	86X0018-001	102
57D6-12	121	76N1	123	86-78-2	100	86-208-2	108	86X0022-001	123
57D6-19	123	76N1B	128	86-79-2	102	86-228-2	124	86X0025-001	123
57D9-1	121	76N2	123	86-80-2	102	86-234-2	128	86X0028-001	124
57D24-1	108	76N2B	128	86-81-2	102	86-235-2	121	86X0029-001	123
57D24-2	108	76N3B	128	86-82-2	102	86-237-2	123	86X0030-001	121MP
57D24-3	108	77	100	86-83-2	102	86-238-2	123	86X0031-001	123
57D69	102	77N1	123	86-84-2	102	86-243-2	108	86X0031-002	123
57D126	102	77N2	123	86-86-2	126	86-244-2	108	86X0031-003	123
57D127	102	77N2B	128	86-87-2	126	86-245-2	108	86X0033-001	131
57D130	126	77N3	123	86-88-2	126	86-246-2	129	86X0034-001	128
57D131	126	77N4	128	86-89-2	126	86-247-2	128	86X0035-001	123
57D132	126	78N1	123	86-90-2	126	86-249-2	102	86X0036-001	106
57D143	102	78BLK	100	86-91-2	126	86-250-2	123	86X0037-001	103
57D156	102	78RED	100	86-92-2	126	86-251-2	126	86X0038-001	128
57D168	126	78YEL	100	86-93-2	102	86-253-2	129	86X6-1	123
57D169	102	78GRN	100	86-95-2	102	86-254-2	126	86X6-4-518	123
57D170	102	78-5009	121	86-98-2	102	86-255-2	123	86X7-2	128
57D180	100	79P1	100	86-99-2	126	86-257-2	124	86X7-3	128

## TRANSISTORS (cont'd)

Type To Be Replaced	Sylvania ECG Replacement	Type To Be Replaced	Sylvania ECG Replacement	Type To Be Replaced	Sylvania ECG Replacement	Type To Be Replaced	Sylvania ECG Replacement	Type To Be Replaced	Sylvania ECG Replacement
86X8-1	123	100X6	130	121-19	102	121-150	126	121-296	126
86X8-3	123	101-12	100	121-21	101	121-151	100	121-297	126
86X34-1	128	101A	126	121-22	101	121-152	126	121-298	126
90T2	107	101B	126	121-24	101	121-153	100	121-299	126
91A	128	101M	126	121-25	101	121-154	100	121-300	100
91B	128	101P1	106	121-26	101	121-157	126	121-301	100
91BGRN	128	104	128	121-27	102	121-160	100	121-302	123
91C	128	104-17	126	121-33	103	121-161	100	121-303	100
91D	128	104-19	126	121-34	126	121-162	100	121-304	108
91E	128	104-21	126	121-135	126	121-163	100	121-305	102
91F	128	104H01	128	121-136	126	121-164	102	121-306	102
91N1	108	104T2	130	121-137	126	121-179	100	121-307	102
92N1	108	106KB0	129	121-138	126	121-180	100	121-308	121
92N1B	108	106P1	104	121-139	126	121-181	100	121-309	102
93A9	102	107A	102	121-44	100	121-184	102	121-310	102
93A9-3	100	107B	102	121-45	100	121-185	126	121-311	102
93A9-4	100	107BRN	128	121-46	100	121-186	100	121-312	126
93C39-11	123	107M	102	121-47	102	121-187	100	121-313	126
94N1	123	108-1	126	121-48	100	121-189	100	121-314	102
94N1B	128	108-2	126	121-49	100	121-190	102	121-315	124
94N1R	123	108-3	126	121-50	100	121-191	102	121-319	102
96N1	124	108-4	126	121-51	102	121-192	102	121-320	102
96XZ6051-28N	126	108GRN	129	121-52	102	121-193	102	121-321	100
96XZ6051-35N	126	110P1	129	121-53	100	121-205	100	121-322	102
96XZ6051-36N	126	112-001	100	121-54	100	121-206	100	121-328	126
96XZ6053-09N	102	112-002	126	121-59	101	121-207	100	121-329	126
96XZ6053-10N	126	112-003	102	121-60	101	121-208	100	121-330	126
96XZ6053-24N	126	112-004	102	121-61	102	121-219	100	121-331	126
96XZ6053-27N	102	112-000172	126	121-62	100	121-220	100	121-332	126
96-138-2	108	112-000185	126	121-63	100	121-221	100	121-333	126
96-5143-01	121	112-000187	121	121-64	102	121-222	100	121-334	126
96-5143-02	121	112-000267	121	121-65	100	121-225	100	121-335	102
96-5165-01	128	112-003	102	121-66	100	121-226	102	121-336	126
96-5190-01	123	112-2	129	121-67	100	121-227	102	121-347	102
97N2	101	113-118	123	121-68	102	121-228	126	121-348	102
97P1	102	114-118	108	121-69	102	121-229	126	121-349	126
98P1	129	115-1	123	121-70	101	121-230	126	121-350	126
99AT6	102	115-4	123	121-71	101	121-231	126	121-351	126
99B5	102	116-1	124	121-72	100	121-232	102	121-352	126
99BA6	100	117-1	124	121-73	100	121-233	126	121-353	100
99B6E	100	118-1	108	121-74	100	121-234	100	121-354	126
99K7	101	118-2	108	121-75	100	121-235	100	121-356	126
99L6	103	118-3	108	121-76	100	121-236	100	121-357	126
99P1	129	118-4	108	121-78	100	121-237	100	121-358	126
99P1M	129	119	128	121-79	100	121-238	100	121-359	126
99P2	129	119-0077	128	121-80	100	121-239	100	121-363	100
99SA7	101	120BLU	128	121-81	100	121-240	100	121-364	123
99SK7	101	120-1	128	121-82	100	121-241	100	121-365	100
99SQ7	103	120-2	128	121-83	100	121-242	126	121-366	123
99S001	121	120-3	128	121-84	100	121-243	126	121-367	123
99S002	102	120-001192	100	121-85	100	121-244	126	121-369	123
99S003	100	120-001195	102	121-86	100	121-245	126	121-371	121
99S004	102	120-002013	102	121-87	100	121-246	102	121-372	102
99S005	102	120-00213	126	121-88	100	121-247	100	121-373	102
99S011	102	120-002213	126	121-89	100	121-248	100	121-374	102
99S011A	102	120-002214	126	121-90	100	121-254	100	121-375	102
99S012	123	120-002216	126	121-91	100	121-256	102	121-377	108
99S012A	123	120-002513	126	121-92	100	121-257	126	121-378	108
99S012E	123	120-002515	126	121-93	100	121-258	126	121-379	108
99S014	121	120-002518	126	121-94	100	121-259	126	121-380	108
99S015	121	120-002520	126	121-95	102	121-260	126	121-381	126
99S016	108	120-002521	102	121-96	102	121-261	126	121-382	121
99S017	108	120-002748	102	121-100	100	121-262	126	121-383	126
99S018	108	120-004492	126	121-101	126	121-263	126	121-384	126
99S019	108	120-004493	102	121-102	100	121-266	102	121-385	126
99S019A	108	120-004494	102	121-103	100	121-267	102	121-388	102
99S019B	108	120-004495	102	121-104	100	121-268	100	121-389	121
99S020	123	120-004496	108	121-105	100	121-269	126	121-395	102
99S022	703	120-004497	108	121-106	102	121-270	104	121-396	102
99S025	123	120-190	102	121-107	102	121-271	102	121-397	100
99S031	108	121-1	129	121-113	100	121-272	102	121-398	121
99S032	108	121-1RED	129	121-120	102	121-273	100	121-399	102
99S033	128	121-6	101	121-128	100	121-274	102	121-400	102
99S034	128	121-7	101	121-134	104	121-275	100	121-401	102
99S035	128	121-9	100	121-135	104	121-276	123	121-403	102
99S036	128	121-10	100	121-136	104	121-277	123	121-404	128
99S037	108	121-11	100	121-137	104	121-278	123	121-408	102
100B63	102	121-12	100	121-145	100	121-279	123	121-409	102
100N1	108	121-14	100	121-146	100	121-294	126	121-411	126
100T2	130	121-18	124	121-147	100	121-295	126	121-412	126



TRANSISTORS (cont'd)

Type To Be Replaced	Sylvania ECG Replacement	Type To Be Replaced	Sylvania ECG Replacement	Type To Be Replaced	Sylvania ECG Replacement	Type To Be Replaced	Sylvania ECG Replacement	Type To Be Replaced	Sylvania ECG Replacement
121-413	102	121-616	108	130	128	207A10	108	297V042C04	102
121-414	126	121-630	108	130-138	108	207B	100	297V042H01	102
121-415	126	121-632	102	135ORN	128	207M	100	297V042H02	102
121-417	129	121-633	102	136RED	128	217-1	128	297V042H03	126
121-418	121	121-634	102	145-T1B	126	223	128	297V042H04	126
121-419	129	121-635	102	146-T1	121	229-0180-32	108	297V043H01	102
121-422	123	121-636	102	147-T1	121	229-0180-33	108	297V045H01	126
121-425	102	121-637	123	154A3675-105	102	229-0180-34	108	297V045H02	126
121-426	126	121-638	123	154A3676	126	229-0204-6	108	297V049H01	123
121-427	126	121-639	123	154A3676-205	102	229-0204-23	108	297V049H03	123
121-428	126	121-640	102	154A3677	126	235	100	297V049H04	123
121-430	123	121-641	103	154A3679	102	248-38104-1	128	297V050C02	100
121-431	123	121-662	123	154A3679-5110	126	251M1	103	297V050H01	102
121-432	126	121-671	123	154A3680	121	297V002M04	101	297V050H02	102
121-433	123	121-678	128	154A5943	124	297V002M05	101	297V050H03	102
121-434	123	121-679	129	154A5943-1	124	297V003H03	102	297V051C03	102
121-435	123	121-695	123	154A8681	102	297V003H06	102	297V051C04	102
121-436	124	121-697	126	154-T1	126	297V003H09	102	297V051H01	102
121-437	102	121-698	126	154-T1A	126	297V003M01	102	297V051H02	102
121-441	129	121-699	129	154-T1B	129	297V003M07	102	297V051H03	102
121-442	129	121-706	128	155-T1	126	297V004H03	102	297V051H04	100
121-446	129	121-707	153	156-T1	126	297V004H06	102	297V052C01	102
121-447	123	121-708	152	156WHT	128	297V004H10	102	297V052H01	102
121-448	123	121-709	153	156-043	130	297V004H14	102	297V052H02	102
121-450	123	121-710	152	157-T1	126	297V004H15	102	297V053C01	102
121-461	124	121-711	123	157YEL	129	297V004H16	102	297V053H01	102
121-463	108	121-713	124	159-T1	126	297V004M01	102	297V053H02	102
121-460	108	121-714	126	160-T1	126	297V011H01	126	297V054C01	100
121-461	108	121-722	128	161-T1	126	297V012H01	126	297V054C02	100
121-462	108	121-726	130	161-T2	108	297V012H06	100	297V054H01	100
121-470	108	121-730	128	162-T1	126	297V012H08	100	297V054H02	100
121-471	108	121G3019	128	162-T2	108	297V012H09	100	297V055C01	100
121-472	108	121G3020	128	169-257	124	297V012H10	126	297V055H01	100
121-480	108	121-830	100	169-284	124	297V012H11	126	297V057H01	102
121-481	108	121-1032	102	171-001-9-001	121	297V012H14	102	297V057H02	102
121-482	108	121-1033	102	171-003-9-001	124	297V012H15	126	297V059H01	123
121-483	108	121-1034	102	172-003-9-001	124	297V025H02	102	297V059H02	123
121-488	126	121-1035	102	173A419-2	121	297V025H04	102	297V059H03	123
121-490	102	121-1036	102	173A3936	121	297V025H05	102	297V060H01	124
121-491	100	121-1124	121	173A3963	121	297V025H15	102	297V060H02	124
121-492	100	121-1134	121	173A4419	121	297V026H01	126	297V060H03	124
121-493	100	121-1330	100	173A4419-1	121	297V026H03	100	297V061C01	130
121-494	100	121-1350	100	173A4419-2	121	297V027H01	102	297V061C02	130
121-495	106	121-1360	100	173A4419-3	121	297V032H01	102	297V061C03	123
121-496	106	121-1390	100	173A4420	121	297V033H01	102	297V061C04	123
121-497	129	121-1400	100	173A4420-1	121	297V034H01	126	297V061C05	128
121-497WHT	129	121-1410	101	173A4420-5	121	297V035H01	126	297V061C06	123
121-498	108	122-229	100	173A4422-1	121	297V036H01	126	297V061C07	123
121-499	128	122-1028	105	173A4424	102	297V036H02	126	297V062C01	121
121-500	108	122-1625	121	173A4436	121	297V037H01	102	297V062C05	121
121-510	108	122-1648	126	173A4469	121	297V037H02	102	297V062C06	128
121-520	108	122-1962	103	173A4490-5	128	297V038H01	100	297V063C01	126
121-538	126	122GRN	129	173A4491-2	130	297V038H02	100	297V064B01	126
121-539	126	122YEL	129	174-25566-01	129	297V038H03	100	297V065C01	126
121-540	126	122-1	123	176-003-9-001	108	297V038H04	102	297V065C02	126
121-540B	126	122-2	123	176-004-9-001	108	297V038H05	108	297V065C03	126
121-541	126	124-1	121	176-005-9-001	108	297V038H06	126	297V070C01	126
121-541B	126	127	128	176-006-9-001	108	297V038H07	102	297V070H49	108
121-542	126	127-7	101	176-007-9-001	108	297V038H09	100	297V071C03	124
121-542B	126	128	108	176-008-9-001	123	297V038H10	100	297V072C01	108
121-543	102	128WHT	128	177-001-9-001	129	297V038H11	100	297V072C03	108
121-544	102	129	108	180T2	130	297V038H12	100	297V072C04	123
121-546	108	129WHT	128	180T2A	130	297V040H01	102	297V072C05	128
121-547	108	129-4	102	180T2C	130	297V040H08	102	297V072C06	123
121-551	108	129-5	121	181T2A	130	297V040H10	102	297V073C01	129
121-552	126	129-6	104	181T2C	130	297V040H11	102	297V073C02	129
121-553	126	129-7	104	183P1	129	297V040H12	102	297V073C03	129
121-580	108	129-8	102	189 Power	121	297V040H13	102	297V074C02	123
121-581	123	129-8-1	102	200A	103	297V040H15	121	297V074C03	123
121-582	124	129-8-1A	102	200-010	108	297V040H16	102	297V074C04	123
121-585	126	129-8-2	102	200-015	108	297V041H01	102	297V074C06	123
121-587	128	129-9	121	200-016	123	297V041H02	121	297V074C07	123
121-600	128	129-10	121	201A	126	297V041H03	121	297V074C08	123
121-602	129	129-11	100	201B	126	297V041H04	121	297V074C09	108
121-603	129	129-13	121	201M	126	297V041H05	104	297V074C10	128
121-610	123	129-14	123	201-254343-12	108	297V041H06	121	297V074C11	129
121-612	108	129-15	123	202A	103	297V041H07	104	297V074C12	128
121-613	108	129-16	108	207A	100	297V042C01	102	297V076B01	102
121-614	108	129-17	102	207A1	126	297V042C02	102	297V076C01	102
121-615	106	129-18	102	207A9	108	297V042C03	102	297V077C01	126

## TRANSISTORS (cont'd)

Type To Be Replaced	Sylvania ECG Replacement	Type To Be Replaced	Sylvania ECG Replacement	Type To Be Replaced	Sylvania ECG Replacement	Type To Be Replaced	Sylvania ECG Replacement	Type To Be Replaced	Sylvania ECG Replacement
297V078C01	128	325-1446-26	123	511-519	123	690V040H57	126	775BRN	128
297V078C02	128	325-1446-27	123	512RED	128	690V040H58	126	776GRN	128
297V080C01	129	325-1446-28	123	515	123	690V040H59	126	779BLU	128
297V081C01	102	325-1513-29	123	515-521	108	690V040H60	126	783RED	128
297V082B01	128	325-1513-30	123	515ORN	128	690V040H61	102	784ORN	128
297V082B02	129	325-1513-46	128	516	123	690V040H62	102	785VEL	128
297V082B03	129	325-1771-15	123	517-518	123	690V043H62	102	786	128
299 Power	105	325-1771-16	123	520T1	100	690V043H63	102	787BLU	128
300	102	326T1	100	521T1	100	690V047H54	126	791	128
301	102	350	100	524WHT	128	690V047H55	126	792-286	102
302	102	352	102	576-003-009	126	690V047H56	100	792-287	102
310	102	353	102	576-001-002	102	690V047H57	100	792-288	102
310-068	126	353-9001-001	126	576-0001-003	102	690V047H58	102	792-289	102
310-68	126	353-9001-002	126	576-0001-004	123	690V047H60	102	792-290	102
310-123	126	353-9001-003	126	576-0001-005	123	690V049H81	108	800-196	104MP
310-124	126	353-9002-002	126	576-0001-009	102	690V052H23	102	800-250-102	123
310-139	126	353-9301-001	128	576-0002-002	104	690V052H24	102	800-501-00	123
310-187	123	353-9304-004	129	576-0003-008	126	690V054H21	102	800-502-00	102
310-188	102	353-9306-001	123	576-0003-009	126	690V056H89	126	800-503-00	103
310-189	100	353-9306-002	123	576-0003-010	126	690V056H90	126	800-504-00	126
310-190	126	365T1	100	576-0003-013	126	690V057H25	102	800-505-00	100
310-191	126	386-7118P1	108	576-0003-014	126	690V057H27	102	800-506-00	102
310-192	121	386-7178P1	123	576-0003-015	126	690V057H28	102	800-507-00	121
322T1	100	386-7183P1	130	576-0004-004	128	690V057H59	126	800-509-00	123
323T1	100	386-7184P1	129	576-0004-005	128	690V057H62	126	800-510-01	130
324	102	386-7188P1	108	576-0036-847	123	690V060H58	108	800-516-000	129
324T1	100	394-3074-2	102	576-0036-918	108	690V060H59	108	800-521-01	123
324-019	128	394-3074-5	102	576-0036-919	108	690V061H98	102	800-521-02	123
324-0029	102	394-3097-1	102	576-0036-920	108	690V061H99	102	800-522-01	123
324-0038	126	394-3097-2	102	576-0036-921	108	690V063H14	126	800-522-02	128
324-0041	102	394-3127-1	128	576-0040-051	121	690V063H15	126	800-523-01	123
324-0055	102	394-3127-2	128	576-2000-990	126	690V063H16	102	800-523-02	123
324-0056	102	394-3127-3	128	576-2000-993	126	690V063H17	102	800-524-02	130
324-0086	126	394-3135	130	605	123	690V063H51	102	800-526-00	123
324-0088	102	396-7178P1	108	614X1	126	690V066H44	126	800-527-00	129
324-0089	126	412	100	614X2	126	690V066H45	126	800-528-00	103
324-0090	126	421-6	126	614X3	126	690V066H46	102	800-529-00	123
324-0091	102	417-124	108	614X4	126	690V066H47	102	800-53001	123
324-0092	102	417-125	108	614X5	102	690V066H89	126	801B	108
324-0093	102	417-126	123	614X6	102	690V068H29	126	815-181D	102
324-0098	126	417-127	123	614X7	102	690V068H30	102	818WHT	128
324-0099	126	417-129	108	614X8	103	690V068H31	102	822A	123
324-0106	126	417-132	129	614X9	102	690V070H49	108	822ABLU	128
324-0116	127	417-144	152	614X10	102	690V070H98	108	822B	123
324-0121	126	417-145	153	630-076	123	690V073H59	126	823WHT	128
324-0128	127	420T1	100	642-152	104	690V073H85	126	823B	128
324-0129	126	421T1	100	642-206	104	690V077H34	126	827BRN	128
324-0130	126	421-7	126	650-105	102	690V077H35	126	828GRN	128
324-0131	126	421-8	126	650-106	102	690V077H36	126	829A	106
324-0132	102	421-11	102	650-107	102	690V077H37	102	829B	106
324-0133	102	421-12	102	650-108	102	690V080H36	108	829C	106
324-0134	103	421-13	102	650-109	103	690V080H37	126	829D	106
324-0136	126	421-14	102	660-9	102	690V080H38	128	829E	106
324-0137	126	421-15	102	660-125	128	690V080H39	102	829F	106
324-0138	126	421-16	126	660-126	128	690V080H40	126	830	100
324-0139	102	421-17	126	660-127	108	690V080H41	123	833	129
324-0140	102	421-18	124	660-128	128	690V080H42	127	847BLK	128
324-0142	102	421-19	102	660-131	123	690V080H43	102	881-250-102	123
324-0143	102	421-26	126	660-134	123	690V080H44	127	884-250-001	121
324-0144	102	429-0093-69	126	660-145	123	690V080H45	130	914F298-1	128
324-0145	126	429-0094-39	126	669	106	690V081H07	108	921-7	123
324-0146	102	448A662	128	686-0012	128	690V084H94	108	921-8	123
324-0149	108	454A104	128	686-0112	128	690V084H95	108	921-29B	106
324-0150	108	455-1	126	686-0130	128	690V084H96	108	94T1	100
324-0151	123	473A31	121	686-0210	152	690V086H39	102	955-1	126
324-0152	123	473B6-2	102	686-0243	130	690V086H86	129	955-2	126
324-0154	123	473B6-2A	102	686-143	102	690V086H87	108	955-3	126
324-144	102	473B6-4	102	690V02H69	108	690V086H88	128	964-19862	103
324-6011	128	473B6-5	102	690V010H40	108	690V086H89	128	964-19863	102
325T1	100	473B6-7	102	690V010H41	108	690V086H90	128	964-19864	102
325-0031-303	123	491A948	128	690V010H42	100	694D	123	965T1	102
325-0031-304	123	501E5001M	108	690V028H28	108	703B	128	987T1	102
325-0031-305	123	501T1	100	690V028H48	108	720-35019	102	988T1	102
325-0031-306	102	503T1	100	690V028H69	108	750-137	102	989T1	102
325-0042-351	123	504T1	126	690V028H89	108	750-138	102	990T1	102
325-0076-306	123	505T1	126	690V034H29	126	750-139	102	991T1	102
325-0076-307	123	506T1	126	690V034H30	102	750-140	102	992T1	102
325-0076-308	108	507T1	126	690V034H31	102	770-045	152	992-00271	130
325-1442-8	102	508T1	126	690V034H39	102	773RED	128	992-008-890	128
325-1442-9	124	511-515	123	690V040H56	126	774ORN	128	1004	123

TRANSISTORS (cont'd)

Type To Be Replaced	Sylvania ECG Replacement	Type To Be Replaced	Sylvania ECG Replacement	Type To Be Replaced	Sylvania ECG Replacement	Type To Be Replaced	Sylvania ECG Replacement	Type To Be Replaced	Sylvania ECG Replacement
1004-17	108	2057B2-61	102	3202-5H01	128	4315	102	4584GRN	121
1005	123	2051B2-62	123	3227-E	108	4348	102	4586	126
1005-17	102	2057B2-63	123	3425	100	4349	102	4587	108
1020-17	108	2057B2-64	108	3434	100	4363	126	4589	126
1023-17	102	2057B2-65	126	3435	100	4363ORN	126	4590	106
1024-17	104	2057B2-66	126	3458	100	4363GRN	126	4594	123
1030	129	2057B2-67	126	3500	100	4363BLU	126	4595	126
1032	102	2057B2-68	126	3504	100	4363WHT	126	4596	102
1033	102	2057B2-70	126	3505	128	4364	126	4597	105
1033-1	126	2057B2-71	126	3506	128	4365	126	4597 RED	105
1033-2	126	2057B2-72	102	3507	100	4366	126	4597 GRN	105
1033-3	126	2057B2-73	123	3508	128	4367	126	4603	126
1033-4	126	2057B2-77	126	3509	128	4398	102	4604	126
1033-5	102	2057B2-78	102	3510	108	4450	102	4605	126
1033-6	103	2057B2-79	126	3511	108	4451	100	4605RED	126
1033-7	102	2057B2-80	126	3512	121	4514	126	4607	102
1034	102	2057B2-83	102	3513	108	4456	126	4608	121
1034-17	123	2057B2-84	124	3514	121	4457	126	4619RED	121
1035	102	2057B2-85	108	3515	121	4459	127	4620GRN	121
1036	102	2057B2-86	102	3516	121	4462	102	4621	126
1124	121	2057B2-87	108	3517	100	4463	121	4622	126
1124A	121	2057B2-88	126	3518	128	4464	123	4623	127
1124B	121	2057B2-89	126	3519	123	4465	123	4624	123
1124C	104	2057B2-90	126	3520	124	4466ORN	102	4627	102
1145	100	2057B2-93	126	3523	100	4468BRN	102	4630	123
1146	100	2057B2-97	123	3524	108	4469RED	102	4632	126
1192	102	2057B2-101	108	3532-1	128	4470	123	4648	128
1241A	102	2057B2-102	108	3533-1	129	4470-31	123	4649	121
1248	102	2057B2-104	126	3535	108	4470-32	123	4652	127
1320	102	2057B2-105	126	3537	108	4470M-32	123	4677	126
1329	102	2057B100-7	102	3538	128	4470-33	123	4689	128
1330	102	2058	126	3540	129	4471ORN	102	4700	101
1340	100	2295	124	3541	128	4471YEL	102	4701	130
1349-17	103	2417	124	3543	128	4472GRN	102	4705	123
1350	100	2427	128	3544	100	4473	102	4714	123
1360	102	2443	123	3545	128	4473-1	128	4715	130
1390	100	2445	108	3546	128	4473-2	128	4722RED	121
1400	100	2446	123	3547	128	4473-3	128	4722ORN	121
1410	100	2447	108	3548	128	4473-M3	128	4722YEL	121
1414-179	130	2448	123	3551	126	4473-4	128	4722GRN	121
1414-180	152	2450	108	3551A	126	4473-5	128	4722BLU	121
1459	102	2473	108	3551AGR	126	4473-5X	128	4722PUR	121
1524	123	2474	128	3551ABLU	126	4473-6	123	4727	121
1526	126	2475	123	3552	126	4473-7	128	4730	121
1567	123	2476	108	3553	126	4473-8	128	4732	128
1567-0	123	2477	108	3554	123	4473-9	128	4733	128
1567-2	123	2482	100	3555	123	4473-11	128	4734	128
1858	101	2487B	100	3556	123	4473-12	128	4737	123
2007-01	121	2488A	100	3558	128	4473-A-12	128	4745	106
2011	152	2489A	100	3559	129	4473-N	128	4756	108
2015-00	126	2490A	102	3560	123	4474YEL	102	4765	123
2015-1	130	2491B	124	3561	128	4475GRN	102	4768	128
2015-2	130	2494	127	3562	129	4476BLU	102	4789	128
2015-3	130	2495	128	3563	129	4477PUR	102	4801-1100-011	121
2020-00	126	2496	127	3564	130	4478	129	4815	129
2021-00	126	2500	127	3565	128	4483	128	4819	128
2028-00	108	2502	129	3566	128	4484	100	4820	108
2039-2	101	2546	128	3577	121	4485	100	4821	128
2057B2-4	102	2584	123	3600	102	4486	100	4825	128
2057B2-28	102	2634	108	3607	101	4501	126	4826	128
2057B2-29	102	2700	126	3609	101	4509	102	4837	108
2057B2-32	102	2780	121	3714H1	130	4510	126	4838	123
2057B2-34	102	2780-4	121	3746	100	4545	126	4839	128
2057B2-35	126	2780-5	121	3851	126	4545BLU	126	4840	128
2057B2-38	123	2781	102	3852	100	4545WHT	126	4841	128
2057B2-41	126	2787	123	3907	102	4553BRN	102	4842	128
2057B2-42	126	2791	126	3907 2N404A	126	4553RED	102	4843	128
2057B2-43	102	2797	126	3961	126	4553ORN	102	4844	106
2057B2-44	102	2798	126	3970	100	4553YEL	102	4845	128
2057B2-45	102	2799	126	3999	128	4553GRN	102	4851	107
2057B2-46	103	2900-007	108	4013	129	4553BLU	102	4852	128
2057B2-47	124	2901-010	121	4021	123	4562	102	4853	128
2057B2-48	126	2904-008	121	4022	123	4563	102	4854	123
2057B2-49	102	2904-016	126	4057	128	4564	102	4855	128
2057B2-50	126	2904-029	126	4066	128	4565	102	4857	108
2057B2-51	126	2904-033	108	4085	128	4567	102	4872	124
2057B2-57	102	2904-034	123	4086	128	4570	121	4882	130
2057B2-58	124	2904-035	123	4087	129	4573	105	4888A	121
2057B2-59	123	3002	108	4247	104	4582BRN	121	4888B	121
2057B2-60	100	3011	128	4313	102	4583RED	121	5093	128

## TRANSISTORS (cont'd)

Type To Be Replaced	Sylvania ECG Replacement	Type To Be Replaced	Sylvania ECG Replacement	Type To Be Replaced	Sylvania ECG Replacement	Type To Be Replaced	Sylvania ECG Replacement	Type To Be Replaced	Sylvania ECG Replacement
5226-1	106	17142	102	34219	100	38920	108	40426	124
5226-2	128	17143	102	34220	100	38921	108	40427	124
5253	104	17144	123	34221	100	40004	126	40439	127
5766-25	102	17444	123	34298	121	40005	126	40440	127
6100	102	17887	121	34315	121	40006	126	40461	133
6100-35	102	17945	102	35004	108	40022	104	40461-2	128
6154	126	18105	121	35044	121	40050	104	40462	104
6155	126	18310	124	35045	102	40051	104	40464	130
6158	108	18493	126	35084	104	40051-2	121	40465	130
6162	126	18509	123	35168	126	40053	128	40466	130
6181-1	128	18529	100	35169	126	40080	123	40469	108
6440	102	18530	102	35170	126	40081	123	40470	108
6445	100	18540	100	35201	104	40217	123	40471	130
6452	102	18541	126	35231	121	40218	123	40472	108
6651-486	128	18555	123	35260	104	40219	123	40475	108
7122	128	18601	102	35349	121	40220	123	40476	123
7123	128	18611	102	35449	108	40221	123	40478	108
7124	128	18731	102	35454	102	40222	123	40479	104
7125	128	19278	124	35454-1	102	40231	123	40482	123
7126	128	19420	108	35454-2	102	40232	108	40487	102
7127	128	19645	123	35454-3	102	40233	108	40488	100
7128	128	20738	123	35628	102	40234	108	40491	124
7129	128	20739	129	35677	126	40235	108	40517	123
7131	128	22008	129	35678	126	40236	108	40518	123
7132	128	22158	128	35728	121	40237	108	40519	123
7133	128	30201	102	35815	126	40238	108	40546	124
7134	128	30202	102	35816	126	40239	108	40547	124
7214	108	30203	121	35817	126	40240	108	40578	128
7215	108	30204	102	35818	126	40242	108	40934-1	130
7216	108	30206	102	35819	102	40243	108	42396	133
7217	108	30207	102	35820	102	40244	108	43992-2	101
7218	108	30208	100	35820-1	102	40245	108	44616-1	102
7219	108	30208-2	102	35820-2	102	40246	108	44967-2	102
7220	108	30210	123	35820-3	102	40250	124	45495-2	101
7221	108	30211	121	35824	126	40251	104	46490-2	101
7425	128	30213	126	35885A	121	40253	102	46590-2	103
7426	128	30214	126	35885B	121	40254	104	46591-2	103
7427	128	30215	126	35950	102	40261	126	46592-2	103
7428	128	30216	102	35951	121	40262	126	46593-2	103
7429	128	30218	102	35952	102	40263	102	46631-2	101
7430	128	30219	123	35953	102	40264	124	46774-1	101
7431	128	30221	126	35954	102	40264-V1	124	46775-2	101
7432	128	30222	102	35955	102	40268	100	46776-2	102
7516	123	30223	126	36212V1	108	40269	100	47394-2	102
7810	128	30224	123	36303	121	40280	123	47645-2	103
7811	128	30226	123	36304	121	40283	123	47737-2	102
7812	128	30227	123	36477	121	40290	123	48385-2	103
7813	128	30228	123	36534	102	40294	108	48937-2	126
7814	128	30229	123	36557	102	40295	108	48939-2	126
7815	128	30230	126	36558	102	40309	123	49058-2	103
7816	128	30231	100	36559	126	40311	123	49138-2	101
7817	128	30234	124	36560	126	40314	128	49139-2	102
7818	128	30235	123	36563	126	40315	128	50137-2	128
8405	129	30238	126	36577	129	40316	130	50447-4	121
8540	129	30239	126	36578	108	40317	128	51650	121
9367-1	128	30240	126	36579	128	40320	128	57000-5452	123
9390	102	30241	123	36580	123	40321	123	57000-5503	123
9391	102	30242	123	36581	108	40322	124	61003-4	102
9600	128	30243	123	36582	132	40323	123	64071-1	102
10003	130	30244	102	36634	124	40326	123	65804-62	126
10032	102	30245	124	36816	100	40327	123	65804-63	102
10036	102	30246	121	36847	108	40328	124	67193-85	102
10037	102	30246A	126	36917	128	40329	102	67802	128
10038	100	30247	121	36918	108	40347	128	68504-62	126
10039	100	30248	123	36919	108	40348	128	68504-63	102
12163	104	30254	152	37383	108	40350	128	68895-13	102
12178	104	30256	152	37384	108	40351	108	69107-42	126
12180	126	30257	124	37464	128	40352	108	69107-44	126
15024	121	30259	123	37584	124	40359	102	69107-45	102
15027	121	30268	128	37585	123	40395	102	70231	108
15809-1	123	30269	128	37694	128	40396N	103	70434	121
15810-1	123	30270	106	37730	124	40396P	102	75960CH	102
15835-1	123	30271	153	37800	128	40397	108	77068-3170756	124
15840-1	123	30272	152	38175	103	40398	108	78331	106
15841-1	123	30273	100	38176	102	40400	108	79855	128
16598	102	30274	126	38177	102	40411	130	79856	128
16599	121	30291	128 & 129 (CP)	38178	123	40422	124	80050	121
16958	102	30302	102	38207	108	40423	124	80416C	121
16959	121	34022	121	38208	108	40424	124	86452	102
17047-1	102	34119	100	38209	100	40425	124	86812	123

TRANSISTORS (cont'd)

Type To Be Replaced	Sylvania ECC Replacement	Type To Be Replaced	Sylvania ECC Replacement	Type To Be Replaced	Sylvania ECC Replacement	Type To Be Replaced	Sylvania ECC Replacement	Type To Be Replaced	Sylvania ECC Replacement
86822	123	99103	100	116086	127	121663	123	162002-041	126
86832	102	99104	100	116087	127	121664	123	162002-042	126
86842	102	99105	126	116088	127	122244	102	162002-062	121
90050	121	99106	126	116089	127	122517	108	162002A-062	121
94008	102	99107	126	116091	102	122518	108	162002-090	123
94009	102	99108	126	116092	123	122664	123	162002-095	121
94017	102	99109-1	123	116093	121	122665	102	162002-040	126
94032	121	99109-2	123	116148	123	122901	123	162002-41	126
94050	128	99120	126	116198	108	122902	108	170376	121
94051	128	99121	126	116199	108	122904	108	170376-1	121
94052	128	99201	102	116200	108	123274	123	170407-1	121
95101	126	99202	102	116201	102	123275	124	170479-1	121
95102	126	99203	102	116202	126	123791	102	170665-1	121
95103	126	99204	102	116203	102	123792	121MP	170668-1	121MP
95107	126	99205	102	116206	102	123877	131MP	170783-3	103
95108	126	99206-1	123	116207	126	123940	129	170850-1	121MP
95110	126	99206-2	123	116208	126	123941	128	171003	127
95111	126	99207-2	123	116209	126	124412	108	171004	127
95112	101	99211	102	116279	124	124623	129	171005	126
95113	101	99218	102	116284	129	124624	129	171016	126
95114	101	99250	121	116588	123	124625	126	171017	102
95115	101	99252	124	116683	126	124626	102	171018	102
95116	126	99252-1	124	116684	126	124753	123	171026	123
95117	126	99252-2	124	116685	102	124754	108	171027	123
95118	126	99252-3	124	116686	102	124755	129	171028	108
95119	126	99252-4	152	116687	103	124756	123	171029	108
95120	126	100678	126	116756	126	124757	108	171030	108
95120A	100	100693	102	116757	102	125135	123	171038	108
95121	126	101078	126	116875	123	125137	108	171039	126
95122	126	101434	108	116997	102	125138	108	171040	123
95123	126	101678	101	116998	102	125139	123	171044	108
95124	126	101974	102	117208	102	125140	123	171045	108
95125	108	104009	126	117209	102	125141	123	171046	123
95126	108	104059	126	117210	102	125142	128	171048	108
95127	108	110263	101	117616	100	125143	123	171049	102
95128	108	110494	102	117617	100	125144	128	171052	108
95129	108	110495	103	117618	126	125263	108	171054	108
95130	108	110515	121	117658	126	125389	123	175006-181	126
95131	108	110669	128	117724	126	125390	108	175006-182	126
95201	102	110697	108	117725	126	125475	123	175006-183	126
95202	103	110699	128	117726	126	125972	126	175006-184	126
95203	102	111117	126	117727	102	125994	108	175006-185	126
95204	102	111118	126	117728	102	125995	108	175006-186	102
95208	102	111954	126	117823	108	126093	102	175006-187	102
95209	102	111955	126	118279	124	126093-1	102	186342A	128
95211	101	111956	126	118686	124	126093-2	102	190425	126
95212	102	111957	102	118713	123	126093-4	102	190425A	120
95213	102	111958	103	118822	108	126138	124	198039-0507	131
95214	102	111959	102	119013	126	126150	123	214396	121
95216	123	112296	126	119414	108	126188	124	216986	121
95216YEL	123	113398	108	119526	126	126334	123	217119	105
95216RED	123	113938	108	119554	108	126698	108	217230	105
95217	102	114267	108	119555	108	126699	128	217892	121
95218	102	114525	108	119556	108	126700	129	218502	102
95219	102	115063	104	119557	108	126701	128	218503	102
95220	128	115225	123	119635	123	126702	128	219016	101
95221	123	115227	126	119636	123	126703	128	219301	121
95222-1	102	115228	126	119650	124	126704	128	219940	121
95222-2	103	115229	126	119722	127	126705	128	221600	123
95223	108	115268	121	119723	127	126706	128	221601	101
95224-1	102	115269	121	119982	123	126707	129	221602	127
95224-2	103	115275	126	119983	129	126708	128	221605	121
95225	123	115281	121	120073	123	126711	123	221856	100
95226-1	128	115282	121	120074	123	126712	123	221857	123
95226-2	123	115283	121	120075	102	126713	123	221918	123
95226-3	129	115284	121	120481	123	126714	128	221924	101
95226-4	128	115875	123	120482	123	126715	129	221940	121
95227	129	115910	128	120483	123	126716	123	221941	121
95228	133	116068	127	121151	102	126717	128	222915	121
95233	128	116072	126	121152	102	126718	129	223124	102
95250	121	116073	108	121153	100	126719	129	223365	102
95250-1	121	116074	123	121154	100	126720	128	223366	121
95251	121	116075	124	121243	129	126721	129	223367	101
95252	124	116078	129	121467	129	126724	128	223368	101
95252-1	124	116079	108	121655	123	126725	128	223369	126
95252-2	124	116080	108	121658	129	126726	124	223370	101
95252-3	124	116081	128	121659	129	127214	132	223371	102
95252-4	124	116082	108	121660	123	127962	100	223372	100
99101	100	116083	108	121661	128-129(CP)	162002-033	121	223473	100
99102	100	116085	123	121662	123	162002-040	126	223474	126

## TRANSISTORS (cont'd)

Type To Be Replaced	Sylvania ECG Replacement	Type To Be Replaced	Sylvania ECG Replacement	Type To Be Replaced	Sylvania ECG Replacement	Type To Be Replaced	Sylvania ECG Replacement	Type To Be Replaced	Sylvania ECG Replacement
223475	100	234630	102	573402	126	610056-1	126	815023B	102
223482	103	234631	126	573405	126	610056-2	126	815024	102
223483	102	235194	102	573406	126	610056-3	126	815024A	102
223484	102	235200	126	573422	102	610056-4	126	815024B	102
223485	102	235205	123	573432	102	610061-1	126	815025	100
223486	102	235206	123	573469	128	610064-1	121	815025A	100
223487	126	235312	121	573472	108	610067-3	121MP	815025B	100
223490	121	235251	108	573475	108	610066-1	104	815026	101
223576	121	236265	101	573479	123	610069-1	108	815026A	101
223684	101	236285	123	573480	123	610070-1	123	815026B	101
223810	102	236286	123	573494	108	610070-2	123	815026C	101
224503	121	236706	108	573495	108	610071-1	124	815026D	100
224584	100	236907	108	573501	128	610072-1	108	815027	100
224586	126	236935	121	573518	126	610072-2	108	815027A	100
224587	126	237450	124	573529	102	610073-1	108	815027B	100
224696	102	237452	121	576001	102	610074-1	129	815027C	100
224820	103	238417	102	576005	102	610074-2	100	815028	102
224857	102	238418	102	601040	102	610075-1	123	815028A	100
224873	121	297074C11	129	601054	126	610076-1	123	815028B	100
225311	126	297240-1	102	601065	103	610076-2	123	815028C	100
225593	102	300486	101	601113	108	610077-1	108	815029	102
225594	126	300536	101	602032	121	610077-2	123	815029A	102
225594A	126	300538	102	602040	102	610077-3	103	815029B	102
225595	121	300540	102	602075	126	610078-1	123	815029C	102
225596	121	300541	102	602113	108	610079-1	102	815030	102
225600	126	300542	101	603020	126	610080-1	102	815030A	102
225925	121	300774	101	603030	126	610083	129	815030B	102
225927	121	309421	102	603031	121	610083-1	129	815031	102
226181	100	310017	102	603040	126	610083-2	129	815031A	102
226338	100	310030	126	603113	108	610083-3	129	815031B	102
226441	101	310035	102	603312	126	610088-2	102	815034	102
226634	121	310132	126	604030	126	610091-1	108	815034A	102
226789	105	310157	126	604040	126	610092-1	108	815034B	102
226791	103	310158	126	604080	126	610094-1	123	815034C	102
226924	102	310159	102	604112	126	610096-1	108	815036	100
226999	121	310160	102	604113	108	610099	129	815036A	100
227752	100	310162	126	605030	102	610099-1	129	815036B	100
227804	121	310201	102	605112	803	610099-2	129	815036C	100
228229	121	310204	126	605113	108	610099-3	102	815037	100
228230	121	310221	126	606020	102	610100-1	108	815037A	100
228287	102	310223	100	607030	123	610102-1	106	815037B	100
228558	121	310224	126	608112	121	610106-1	104	815037C	100
228559	121	310225	102	609020	126	610107-1	108	815038	102
229045	105	373003	102	609112	123	610107-2	128	815038A	102
229133	126	373117	102	610035	102	610110-1	129	815038B	102
230208	121	373119	102	610035-1	102	611020	100	815038C	102
230209	101	551051	102	610035-2	102	612020	127	815041	100
230214	128	560004	121MP	610036-1	102	613112	108	815041A	100
230253	102	5700005452	123	610036-2	102	660059	102	815041B	100
230256	101	5700005503	123	610036-3	102	660060	102	815041C	100
230259	102	570004-503	123	610336-4	102	660070	128	815043	100
230523	121	570005-452	123	610036-5	102	660072	102	815043A	100
230524	102	570005-503	123	610036-7	102	660074	128	815043B	100
230525	102	570009-01-504	123	610036-8	102	660082	102	815043C	100
231374	123	573001	102	610039-1	121	660095	121	815055	100
231588	102	573005	102	610040-1	102	660103	121	815056	100
231672	121	573011	102	610040-2	102	670850-1	121MP	815057	100
231797	121	573012	102	610041-2	108	700080	130	815058	102
232194	121	573018	102	610041-3	108	700083	108	815058A	102
232359	130	573022	102	610042-1	108	700230-00	123	815058B	102
232674	121	573029	102	610043-3	102	700231-00	123	815058C	102
232675	121	573101	108	610043-4	100	701584-00	129	815058X	100
232676	126	573103	102	610043-6	100	701678-00	108	815064	126
232680	126	573117	102	610043-7	102	702047-00	128	815064A	126
232681	126	573119	102	610045-2	108	702415-00	123	815064B	126
232840	108	573125	102	610045-3	123	731009	102	815064C	126
232841	128	573142	102	610045-4	123	815003	102	815065	100
232949	101	573152	102	610050-1	126	814044A	102	815065A	100
233305	105	573153	102	610050-2	126	815015	102	815065B	100
233307	105	573166	121	610050-3	126	815020	100	815065C	100
233507	100	573199	127	610051-1	126	815020A	100	815066	100
233508	105	573200	102	610051-2	126	815020B	100	815066A	100
233509	121	573212	127	610051-4	126	815021	100	815066B	100
233945	100	573303	126	610052-1	100	815021A	100	815066C	100
234015	126	573329	126	610053-1	126	815021B	100	815067	126
234076	102	573330	126	610053-2	126	815022	102	815067A	126
234077	121	573335	126	610055	126	815022A	102	815067B	126
234078	105	573336	126	610055-1	126	815022B	102	815067C	126
234566	121	573371	126	610055-2	126	815023	102	815068	126
234612	123	573398	126	610055-3	126	815023A	102	815068A	126

TRANSISTORS (cont'd)

Type To Be Replaced	Sylvania ECC Replacement	Type To Be Replaced	Sylvania ECC Replacement	Type To Be Replaced	Sylvania ECC Replacement	Type To Be Replaced	Sylvania ECC Replacement	Type To Be Replaced	Sylvania ECC Replacement
815068B	126	815184E	123	981144	126	2001653-20	126	2091859-0712	121
815068C	126	815185	129	981145	126	2001653-21	102	2091859-0713	104
815069	102	815185E	129	981146	126	2001653-23	102	2091859-0714	121
815069A	102	815186	123	981148	102	2001653-24	102	2091859-0715	104
815069B	102	815186C	123	981203	126	2001812-65	100	2091859-0716	104
815069C	102	815186L	123	981204	126	2002153-58	126	2091859-0717	104
815070	102	815189	102	981206	102	2002153-59	126	2091859-0718	104
815070A	102	815190	123	981672	102	2002153-60	126	2091859-0720	104
815070B	102	815191	123	981673	102	2002153-71	102	2091859-0723	121
815070C	102	815193	126	981674	102	2002153-76	126	2091859-72	121
815070D	102	815195	102	981675	102	2002153-77	123	2091859-4	121
815074	102	815196	102	981969	105	2002153-78	102	2091859-6	121
815075	103	815197	126	982150	126	2002153-83	103	2091859-8	104
815076	103	815198	128	982151	102	2002210-110	102	2091859-0008	121
815083	102	815199-6	129	982152	102	2002211-24	102	2091859-9	121
815101	100	815201	123	983874	121	2002211-25	102	2091859-10	121
815103	100	815202	128	983945	105	200232-55	108	2091859-0011	121
815104	102	815203-3	21M P	983975	121	2002336-19	102	2091859-11	121
815105	100	815206	108	985036	121	2002403-19	102	2092417-0707	126
815107	100	815308A	100	985431	121	2002620-18	108	2092417-0708	126
815108	100	816135	124	985432	105	2002620-19	108	2092417-0709	126
815109	100	825065	100	985443	100	2002621-2	123	2092417-0710	126
815114	102	910799	128	985447	121	2003073-8	102	2092417-0711	108
815115	100	965632	108	985449	121	2003073-9	123	2092417-0712	108
815116	100	965633	108	985453	121	2003073-10	123	2092417-0713	108
815117	100	965634	108	985455	121	2003073-11	126	2092417-0715	108
815118	102	980062	105	985686	121	2003073-12	126	2092417-0716	108
815120	102	980132	121	988080	121	2003073-13	126	2092417-0717	126
815120A	102	980134	105	988336	121	2003073-14	102	2092417-1	126
815120B	102	980135	105	988413	121	2003073-15	102	2092417-2	126
815120C	102	980136	100	988414	105	2003073-16	103	2092417-3	126
815120D	102	980138	108	988468	121	2003073-91	130	2092417-6	126
815120E	102	980139	108	988977	105	2003168-135	123	2092418-071	126
815133	123	980140	126	989171	105	2003168-136	123	2092418-0710	126
815134	123	980142	126	989387	121	2003779-22	108	2092418-0711	101
815136	102	980144	102	989615	105	2003779-23	108	2092418-0712	126
815137	121M P	980146	126	989632	105	2003779-24	108	2092418-0715	108
815138	121	980147	123	989633	105	2003779-25	108	2092418-0716	108
815139	102	980148	102	994334	108	2004746-87	124	2092418-0717	108
815158	102	980149	102	995001	121	2004746-114	108	2092418-0719	108
815160	102	980150	127	995002	102	2004746-115	108	2092418-0720	108
815160A	102	980153	102	995003	102	2057013-0701	129	2092418-0721	108
815160B	102	980155	121	995014	121	2057013-0702	129	2092418-0724	108
815160C	102	980372	126	995030	124	2057013-0703	129	2092418-1	126
815160D	102	980373	126	1473514-1	127	2076393	126	2092428-2	126
815160E	102	980374	126	1810037	108	2076403	108	2092418-5	126
815160F	102	980375	102	1810038	108	2076403-0703	126	2092418-6	126
815160H	102	980376	102	1810039	108	2076495-0701	102	2092418-7	126
815164	108	980426	100	1944748	102	2090056-1	104	2092609-001	123
815165	108	980432	100	1956016	121	2090056-5	104	2092609-0001	123
815166	124	980434	100	1960584	121	2090056-27	104	2092609-0002	123
815166-4	124	980435	126	1960643	102	2090924E	102	2092609-0022	123
815167-3	124	980437	121	1961480	121	2090924-008	102	2092609-0705	123
815170	108	980438	100	1961835	121	2090924-0008	102	2092609-0706	123
815171	123	980439	100	1961837	102	2090924-8	102	2092609-0707	123
815171D	123	980440	123	1965017	121	2090924-8A	102	2092609-0713	123
815172	108	980441	126	1966079	121	2091211-0014	102	2092609-0715	123
815172A	108	980452	105	1967799	128	2091241-0005	126	2092609-0718	123
815173	108	980463	105	1967799-1	128	2091241-0719	126	2092609-0720	128
815173A	108	980505	126	1967801	128	2091241-1	100	2092609-0721	123
815173C	108	980506	126	2000287-28	102	2091241-2	100	2092609-1	101
815173F	108	980507	126	2000625-31	102	2091241-3	100	2092609-2	101
815174	123	980508	102	2000625-32	102	2091241-5A	102	2092609-3	123
815174L	123	980509	126	2000625-33	102	2091241-7	100	2092609-5	101
815175	124	980510	102	2000625-34	102	2091241-0013	100	2092693-0724	108
815175H	124	980511	102	2000646-103	123	2091241-13	100	2092693-0725	108
815177	102	980514A	126	2000646-104	126	2091241-13A	100	2092693-1	102
815178	102	980545A	126	2000646-105	108	2091241-0014	100	2092693-2	126
815179	102	980626	126	2000646-106	126	2091241-14	100	2092693-3	126
815180-3	124	980636A	126	2000646-107	123	2091241-15	100	2092693-4	126
815180-4	124	980833	126	2000646-108	102	2091241-15A	100	2092693-8	102
815180-7	124	980834	126	2000646-109	127	2091241-0015	100	2092693-9	126
815181	102	980835	126	2000646-110	127	2091241-0018	102	2093308-070	108
815181A	102	980836	102	2000646-111	102	2091260-1	103	2093308-0701	101
815181B	102	980837	102	2000646-113	121	2091260-2	103	2093308-0702	101
815181C	102	980958	126	2000752-80	128	2091260-3	101	2093308-0703	101
815181D	102	980959	126	2000757-80	108	2091578-0702	102	2093308-0704	123
815182	123	980960	102	2000804-7	123	2091578-1	102	2093308-0705	108
815183	123	980961	102	2000804-8	123	2091859-11	121	2093308-0706	108
815184	123	981143	126	2000804-9	102	2091859-0711	108	2093308-0708	123

## TRANSISTORS (cont'd)

Type To Be Replaced	Sylvania ECG Replacement	Type To Be Replaced	Sylvania ECG Replacement	Type To Be Replaced	Sylvania ECG Replacement	Type To Be Replaced	Sylvania ECG Replacement	Type To Be Replaced	Sylvania ECG Replacement
2093308-1	108	8020540	102	A1M-1	128	A158C	123	AC116	102
2093308-2	108	8020560	102	A1N	124	A159B	123	AC117	102
2093308-3	108	8021897	102	A1P	128	A163	126	AC117P	102
2097013-0702	128	8021898	102	A1P-1	128	A168	123	AC120	102
2324235-1	102	8022630	102	A1P/4922	108	A170	129	AC121	102
2320031	108	8023892	102	A1P/4923	108	A301	108	AC122	108
2495012	100	8024250	127	A1R	128	A306	108	AC122GRN	100
2495013	100	8024390	102	A1R-1	128	A307	108	AC122RED	100
2495014	102	8538640	126	A1R-2	128	A310	128	AC122YEL	100
2495166-1	108	9100502	102	A1R/4924	108	A311	128	AC123	102
2495166-2	123	9100621	102	A1R-1/4925	108	A321	108	AC124	100
2495166-4	123	9100706	102	A1R-2/4926	108	A344	108	AC125	100
2495166-8	123	9100944	102	A1S	128	A345	108	AC126	100
2495166-9	123	13020000	102	A1T	123	A346	108	AC127	103
2495200	100	13020002	102	A1T-1	123	A376	126	AC127-132	103
2712080	123	23114001	108	A1U	108	A415	108	AC128	100
3004856	102	23114004	127	A1V	128	A417	128	AC129	126
3005861	123	23114009	127	A1W	123	A418	128	AC130	101
3146977	130	23114015	123	A1Z	108	A419	128	AC131	102
3152170	130	23114026	127	A2A	128	A420	128	AC132	102
3170757	128	23114031	108	A2B	108	A435	126	AC134	108
3539307-001	108	23114033	121	A2C	108	A466	128	AC135	100
3539307-002	108	23114034	108	A2D	108	A467	108	AC136	100
4080187-0502	152	23114043	108	A2E	130	A473	108	AC137	102
4813466	123	25114116	108	A2EBLK	130	A480	128	AC138	102
6100724-2	100	25114121	108	A2EBRN	130	A482	128	AC141	101
7026011	108	25114130	123	A2F	108	A483	128	AC141B	101
7026012	108	25114143	152	A2FGRN	123	A484	128	AC141K	101
7026013	108	25114161	108	A2G	108	A485	128	AC150	102
7026014	123	27125080	123	A2H	108	A490	128	AC150GRN	100
7026015	123	27125090	123	A2J	128	A492	128	AC150YEL	100
7026016	123	27125140	123	A2K	128	A494	123	AC151	100
7026019	129	27125150	102	A2L	123	AS14-027662	102	AC151R	100
7026020	123	27125160	123	A2M	128	AS52	130	AC152	102
7274653	121	27125210	108	A2N	128	A567	123	AC153	102
7276211	100	27125230	126	A2N-1	128	A567A	123	AC153K	102
7276605	105	27125240	100	A2N-2	128	A572	130	AC154	102
7278421	100	27125250	123	A2P	128	A667RED	108	AC155	102
7278422	102	27125260	102	A2S	130	A748	123	AC156	102
7278423	102	27126220	108	A2SB240A	104	A749	123	AC157	103
7279293	105	48134666	123	A2SB242A	104	A937-1	123	AC160	126
7279379	100	61260039	126	A2SB248A	104	A937-3	123	AC160A	126
7279779	126	61260039A	126	A2T	128	A1016	129	AC160B	126
7279780	126	570004503	123	A2U	124	A1109	108	AC160GRN	100
7279781	126	5700045452	123	A2V	108	A1170	108	AC160RED	100
7279788	100	570005503	123	A2W	128	A1220	126	AC160YEL	100
7279789	100	152221011	102	A2Y	108	A1243	100	AC161	102
7279940	100	1522210131	126	A2Z	128	A1314	128	AC162	102
7279941	100	1522210300	126	A3E	128	A1341	128	AC163	102
7281307	100	1522210921	126	A3F	128	A1377	108	AC164	126
7281308	100	1522211021	126	A3G	128	A1378	100	AC165	102
7281309	100	1522211200	102	A3K	128	A1379	128	AC166	102
7281310	102	1522211328	102	A3M	128	A1380	123	AC167	102
7281891	100	1522214400	126	A3N	128	A1383	126	AC168	102
7282315	105	1522214411	126	A3T	123	A1384	126	AC169	126
7284751	102	1522214435	126	A3U	130	A1462	108	AC170	100
7285663	121	1522214821	126	A3W	128	A1518	108	AC171	100
7292308	126	1522216500	102	A3Y	128	A1519	108	AC172	101
7294133	102	1522216600	126	A3Z	128	A1520	108	AC175	103
7295195	108	1522217400	126	A4A	128	A1521	108	AC175P	103
7295196	108	1522223720	123	A4B	128	A1567	123	AC160YEL	101
7296314	123	3121004900	126	A4F	128	A1567-1	123	AC180	102
7570003-01	121	3121007744	126	A4G	108	A3011112	128	AC181	102
7570004	123	3121024033	126	A4H	128	A403764-2	129	AC182	100
7570004-01	123	3121024044	126	A18	130	AA1	102	AC183	101
7570005	123	3121047111	126	A24	108	AA2	101	AC184	100
7570005-01	123	3122005400	102	A102	126	AA3	126	AC185	101
7570005-02	123	5700045452	123	A104	123	AA4	121	AC186	101
7570005-03	123	57000901504	123	A106	108	AA5	105	AC187	103
7570008	123	A1A	123	A107	128	AC105	102	AC187/01	103
7570008-02	123	A1B	123	A108	123	AC106	102	AC188	102
7570009-01	123	A1E	108	A111	123	AC107	126	AC188/01	102
7570009-21	128	A1F	123	A115	128	AC107M	126	ACV17	102
7570013-01	129	A1G	108	A122	126	AC108	102	ACV18	102
7570022-01	130	A1G-1	128	A128	123	AC109	102	ACV19	102
8000736	128	A1H	123	A128A	123	AC110	102	ACV20	102
8000737	128	A1J	128	A132	128	AC113	102	ACV21	102
8020322	102	A1K	108	A156	123	AC113A	102	ACV22	102
8020324	102	A1L	123	A158	123	AC114	102	ACV23	102
8020333	102	A1M	128	A158B	123	AC115	102	ACV27	100



TRANSISTORS (cont'd)

Type To Be Replaced	Sylvania ECG Replacement	Type To Be Replaced	Sylvania ECG Replacement	Type To Be Replaced	Sylvania ECG Replacement	Type To Be Replaced	Sylvania ECG Replacement	Type To Be Replaced	Sylvania ECG Replacement
ACY28	102	AF142	100	AR8	104	AT11	126	B1274B	121
ACY29	102	AF143	100	AR8P404R	121	AT12	126	B1368	121
ACY30	102	AF144	126	AR9	104	AT13	126	B1368A	121
ACY31	102	AF146	100	AR10	104	AT14	126	B1368B	121
ACY32	102	AF147	126	AR11	104	AT15	100	B1368C	121
ACY34	102	AF148	126	AR12	104	AT16	100	B1368D	121
ACY35	102	AF149	126	AR13	104	AT17	100	B1368E	121
ACY36	102	AF150	126	AR14	121	AT20H	102	B1368F	121
ACY38	100	AF164	102	AR15	124	AT20M	102	B3746	128
ACY40	100	AF165	102	AR18	124	AT20N	102	B5000	152
ACY41	102	AF166	126	AR102	102	AT30H	102	B10064	104
ACY44	102	AF168	102	AR103	126	AT30M	102	B10069	104
AD103	121	AF169	126	AR104	126	AT30N	102	B10142	127
AD104	121	AF170	126	AR105	126	AT50	102	B10142A	127
AD105	121	AF171	126	AR107	123	AT52	101	B10142B	127
AD130	121	AF172	126	AR108	123	AT53	101	B10143	127
AD131	121	AF178	126	AR200	108	AT71	101	B10143A	127
AD132	121	AF179	126	AR201	108	AT72	101	B10162	121
AD138	104	AF180	126	AR202	108	AT73R	101	B10163	121
AD138/50	121	AF181	126	AS33867	102	AT74	101	B10474	121
AD139	104	AF182	126	AS33868	102	AT75R	101	B10475	121
AD140	121	AF185	126	AS34280	101	AT76R	101	B10912	121
2-AD140	121	AF186	102	ASY12-1	126	AT77	101	B10913	121
AD143	121	AF186G	106	ASY12-2	126	AT100H	102	B170000	130
AD148	131	AF186W	126	ASY13-1	126	AT100M	100	B170000BLK	130
AD149	127	AF188	102	ASY13-2	126	AT100N	102	B170000BRN	130
AD150	121	AF192	101	ASY14	126	AT312	128	B170001	130
AD152	131	AF193	100	ASY14-1	126	AT316	128	B170001BLK	130
AD155	131	AF200	126	ASY14-2	126	AT521	101	B170001BRN	130
AD156	131	AF201	126	ASY14-3	126	AT551	101	B170002	130
AD157	131	AF202	126	ASY24	126	AT1856	130	B170003	130
AD159	121	AF202S	102	ASY26	100	AT5156	129	B170004	130
AD162	131	AFY10	126	ASY27	100	ATGP	102	B170005	130
AD164	131	AFY11	126	ASY28	101	AU101	127	B170006	130
AD166	127	AFY12	126	ASY29	101	AU102	127	B170007	130
AD167	127	AFY14	126	ASY30	126	AU105	127	B170009	130
AD169	131	AFY15	100	ASY31	100	AUY10	104	B170010	130
ADY22	121	AFY16	126	ASY32	100	AUY19	121	B170011	130
ADY23	121	AFY18	100	ASY48	100	AUY20	121	B170012	130
ADY24	121	AFY34	102	ASY49	126	AUY21	104	B170013	130
ADY26	105	AFY37	102	ASY50	100	AUY22	104	B170014	130
ADY27	121	AFY39	102	ASY51	100	AUY28	127	B170015	130
ADZ11	105	AFY40	126	ASY52	126	AV105	121	B170016	130
ADZ12	105	AFY40K	126	ASY53	101	AX91770	108	B170018	130
AE50	102	AFZ10	100	ASY54	102	B2SB244	104	B170019	130
AEX79846	130	AFZ11	100	ASY55	126	B2SB244	104	B170020	130
AF101	100	AFZ12	102	ASY56	126	B5	102	B170021	130
AF102	126	AFZ23	100	ASY57	126	B5A	102	B170022	130
AF105	126	AG134	126	ASY58	126	B22-3	102	B170024	130
AF105A	126	AL100	127	ASY59	126	B22-4	102	B170025	130
AF106	126	AL102	127	ASY61	126	B23	102	B5493957-4	129
AF107	100	AL103	127	ASY62	101	B23-1	102	B5493957-5	129
AF108	100	AL210	100	ASY63	126	B23-2	102	B5493957-6	129
AF109	126	ALZ10	100	ASY67	126	B24-1	102	BA6	100
AF111	100	AM3235	130	ASY70	102	B26	102	BA6A	100
AF112	100	AMF104	130	ASY71	126	B49	102	BA67	128
AF113	100	AMF105	130	ASY72	101	B51	126	BA71	128
AF114	126	AMF115	130	ASY73	101	B131	152	BB71	128
AF115	126	AMF116	130	ASY74	101	B132	153	BC71	128
AF116	126	AMF117	130	ASY75	101	B134	121	BC107	123
AF117	126	AMF117A	130	ASY76	100	B134A	121	BC107A	108
AF118	126	AMF118	130	ASY77	100	B134C	121	BC107B	108
AF120	126	AMF118A	130	ASY80	100	B169	123	BC108	123
AF121	126	AMF119	130	ASY86	101	B177	121	BC108A	108
AF124	126	AMF119A	130	ASY87	101	B178	121	BC108B	108
AF125	126	AMF120	130	ASY88	101	B179	121	BC108C	108
AF126	126	AMF120A	130	ASY89	101	B224	121	BC109	108
AF127	126	AMF210	130	ASZ10	126	B1017	104	BC109B	108
AF128	100	AMF210A	130	ASZ11	126	B1022	102	BC109C	108
AF129	126	AO1	126	ASZ15	121	B1058	102	BC111	108
AF130	126	AO7	101	ASZ17	121	B1151	104	BC112	108
AF131	126	AO2	128	ASZ18	121	B1151A	104	BC113	123
AF132	126	AQ3	128	ASZ20	102	B1151B	104	BC114	128
AF133	126	AQ4	123	ASZ21	102	B1152	104	BC115	128
AF134	126	AQ5	128	ASZ30	126	B1152A	104	BC116	129
AF135	126	AQ6	123	AT6	102	B1152B	104	BC117	128
AF136	126	AR4	104	AT6A	102	B1154	102	BC118	128
AF137	126	AR5	104	AT10H	102	B1215	121	BC119	128
AF138	126	AR6	104	AT10M	102	B1274	121	BC120	128
AF139	126	AR7	104	AT10N	102	B1274A	121	BC121	123

## TRANSISTORS (cont'd)

Type To Be Replaced	Sylvania ECG Replacement	Type To Be Replaced	Sylvania ECG Replacement	Type To Be Replaced	Sylvania ECG Replacement	Type To Be Replaced	Sylvania ECG Replacement	Type To Be Replaced	Sylvania ECG Replacement
BC122	123	BD111	130	BFY45	128	BSY34	123	C424	108
BC123	123	BD112	130	BFY46	128	BSY38	128	C425	128
BC125	123	BD113	130	BFY47	128	BSY39	128	C426	128
BC126	129	BD115	123	BFY48	128	BSY44	124	C444	108
BC127	108	BD116	130	BFY49	128	BSY45	124	C450	108
BC128	108	BD118	130	BFY50	128	BSY46	124	C536E	123
BC129	123	BD119	124	BFY51	128	BSY51	123	C537F	123
BC130	123	BD120	124	BFY52	128	BSY52	123	C673	133
BC131	123	BD121	130	BFY55	128	BSY53	123	C674	133
BC134	108	BD132	153	BFY56	128	BSY54	123	C684	133
BC135	128	BD153	123	BFY56A	128	BSY55	123	C684A	133
BC136	128	BDY10	130	BFY63	128	BSY56	128	C685	133
BC138	128	BDY11	130	BFY64	128	BSY58	123	C693E	123
BC139	129	BDY12	130	BFY65	128	BSY62	128	C693G	123
BC140	128	BDY13	130	BFY66	128	BSY63	128	C960	103
BC140A	128	BE5	100	BFY67	128	BSY70	108	C1437	100
BC140B	128	BE6A	100	BFY67A	128	BSY71	128	C1438	100
BC140C	128	BE71	128	BFY67C	128	BSY72	128	C9080	106
BC140D	128	BF115	108	BFY68	128	BSY73	108	C9081	106
BC141	128	BF153	108	BFY68A	128	BSY74	108	C9082	106
BC142	128	BF154	128	BFY69	128	BSY75	128	C9083	106
BC143	128	BF155	108	BFY69A	128	BSY76	128	C9084	106
BC148	108	BF158	108	BFY69B	128	BSY77	128	C9085	106
BC148C	123	BF159	108	BFY70	128	BSY78	128	C1215.2	126
BC149	123	BF160	108	BFY72	128	BSY79	128	C10227	102
BC153	129	BF162	108	BFY74	128	BSY80	108	C10230.3	102
BC154	106	BF163	108	BFY75	108	BSY81	128	C10258	126
BC155	128	BF164	108	BFY76	123	BSY82	128	C10260	126
BC180	108	BF165	128	BFY77	123	BSY83	128	C10261	126
BC442	108	BF166	128	BFY78	108	BSY84	128	C10262	126
BC1073	104	BF167	128	BFY79	108	BSY85	128	C10279-1	123
BC1073A	104	BF169	128	BFY90	108	BSY86	128	C10279-3	123
BC1274	104	BF173	108	BFY99	128	BSY87	128	C11021	102
BC1274A	104	BF175	128	BG71	128	BSY88	128	C36577	129
BC1274B	104	BF184	128	BH71	128	BSY90	123	C36578	128
BC6500	108	BF185	128	BI71	128	BSY91	128	C36579	128
BCY10	106	BF187	108	BI7201	123	BSY92	128	C36580	128
BCY11	106	BF188	108	BLY10	130	BSY93	108	CB1F4	105
BCY12	106	BF189	108	BLY11	130	BSY95	108	CD0000	123
BCY13	108	BF216	128	BLY12	130	BSY95A	108	CD0014	123
BCY15	123	BF217	128	BLY15	130	BSY168	108	CD0021	123
BCY16	123	BF218	128	BLY47	130	B76	128	CD8006	123
BCY17	106	BFX12	106	BLY48	130	BT71	128	CD12000	123
BCY18	106	BFX13	106	BLY49	130	BU67	128	CDC8021	128
BCY19	106	BFX17	128	BLY50	130	BU71	128	CDC12077F	123
BCY21	106	BFX18	108	BLY61	128	BUY10	130	CDC13000-18	123
BCY22	106	BFX19	108	BP67	128	BUY11	130	CDC13016A	123
BCY23	106	BFX20	108	BQ67	128	BV67	128	CDQ10001	123
BCY24	106	BFX21	108	BR67	128	BV71	128	CDQ10002	108
BCY25	106	BFX61	108	BS67	128	BW67	128	CDQ10003	123
BCY26	106	BFY10	128	BS475	123	BW71	128	CDQ10004	108
BCY27	106	BFY11	128	BSX12	108	BX67	128	CDQ10005	123
BCY28	106	BFY12	128	BSX21	108	BX71	128	CDQ10006	108
BCY30	106	BFY13	128	BSX22	128	BY67	128	CDQ10008	108
BCY31	106	BFY14	128	BSX24	108	BY71	128	CDQ10009	123
BCY32	106	BFY15	128	BSX25	108	BZ67	128	CDQ10010	108
BCY33	106	BFY16	128	BSX26	108	BZ71	128	CDQ10011	128
BCY34	106	BFY17	128	BSX27	108	C50BA042	128	CDQ10012	128
BCY38	106	BFY18	128	BSX28	108	C63	128	CDQ10014	128
BCY39	106	BFY19	128	BSX29	106	C64	108	CDQ10016	108
BCY40	106	BFY22	128	BSX30	108	C73	100	CDQ10017	108
BCY42	128	BFY23	128	BSX35	106	C75	100	CDQ10018	123
BCY43	108	BFY23A	128	BSX38	108	C76	100	CDQ10019	108
BCY49	106	BFY24	128	BSX53	128	C82S	108	CDQ10020	108
BCY50	123	BFY25	128	BSX54	128	C101	106	CDQ10021	123
BCY51	128	BFY26	128	BSY10	128	C102	106	CDQ10022	108
BCY54	106	BFY27	128	BSY11	108	C103	106	CDQ10023	108
BCY56	108	BFY28	128	BSY17	108	C106	106	CDQ10024	123
BCY58	123	BFY29	128	BSY18	108	C111B	108	CDQ10026	108
BCY59	123	BFY30	128	BSY19	108	C118	106	CDQ10027	108
BCY69	108	BFY33	128	BSY20	108	C119	108	CDQ10032	108
BCY70	129	BFY34	128	BSY21	128	C201	106	CDQ10033	128
BCY72	128	BFY37	128	BSY22	108	C202	106	CDQ10035	108
BCY443	128	BFY39	128	BSY23	128	C302	106	CDQ10036	108
BCZ10	106	BFY39/1	128	BSY24	108	C303	106	CDQ10037	128
BCZ11	106	BFY39/2	128	BSY25	123	C400	108	CDQ10044	128
BCZ12	129	BFY39/3	128	BSY26	108	C401	106	CDQ10045	128
BCZ13	106	BFY40	128	BSY27	108	C402	129	CDQ10046	128
BCZ14	106	BFY43	128	BSY28	108	C402	106	CDQ10047	128
BD71	129	BFY44	128	BSY29	108	C420	128	CDQ10049	124

TRANSISTORS (cont'd)

Type To Be Replaced	Sylvania ECC Replacement	Type To Be Replaced	Sylvania ECC Replacement	Type To Be Replaced	Sylvania ECC Replacement	Type To Be Replaced	Sylvania ECC Replacement	Type To Be Replaced	Sylvania ECC Replacement
CDT1309	121	CK762	126	CS1255HF	128	CTP1729	104	D28D3	152
CDT1310	121	CK766	100	CS1256HG	129	CTP1730	104	D28D4	152
CDT1311	121	CK766A	126	CS1258	123	CTP1731	104	D28D5	152
CDT1312	121	CK768	100	CS1259	123	CTP1732	104	D28D7	152
CDT1319	121	CK776	100	CS1286	123	CTP1733	104	D28D10	152
CDT1320	121	CK776A	100	CS1288	123	CTP1735	104	D29A4	128
CDT1321	121	CK790	102	CS1289	123	CTP1736	104	D29A5	128
CDT1322	127	CK791	102	CS1293	108	CTP1739	121	D30A1	129
CDT1349	121	CK793	102	CS1303	129	CTP3500	104	D63	123
CDT1349A	121	CK794	102	CS1340E	108	CTP3503	104	D64	103
CDT1350	121	CK870	102	CS1340G	108	CTP3504	104	D65	126
CDT1350A	121	CK871	126	CS1368C	123	CTP3508	104	D66	102
CIL511	108	CK872	102	CS1368D	123	CTP3544	104	D101B	102
CIL512	108	CK875	102	CS1369	129	CTP3545	104	D105B	102
CIL513	108	CK878	102	CS2711	128	CTP3552	104	D1101	133
CIL521	108	CK879	102	CS2712	128	CTP3553	104	D1102	133
CIL522	108	CK882	102	CS2713	128	D019	100	D1301	133
CIL523	108	CK888	108	CS2714	128	D031	100	D1302	133
CIL531	108	CK891	102	CS2715	128	D038	100	D1303	133
CIL532	108	CK892	102	CS2716	128	D043	100	D1666	108
CIL533	108	CK942	129	CS2923	128	D063	126	DAT1A	126
CK4	126	CM0770	128	CS2924	128	D078	100	DAT2	100
CK4A	126	CM2550	121	CS3393	128	D079	126	DS1	101
CK13	100	CM2484	128	CS3394	128	D080	127	DS2	101
CK13A	100	CP400	130	CS3396	128	D081	121	DS3	102
CK14	100	CP401	130	CS3397	128	D083	103	DS4	101
CK14A	100	CP404	130	CS3398	128	D085	103	DS5	101
CK16	100	CP405	130	CS3605	128	D086	126	DS6	101
CK16A	100	CP406	130	CS3606	128	D087	108	DS7	101
CK17	100	CP407	130	CS3607	128	D088	108	DS8	101
CK17A	100	CP408	130	CS3707	128	D1A	123	DS9	101
CK22	102	CQ1940A	104	CS3708	128	D1F	101	DS11	101
CK22A	102	CQ1940B	104	CS3709	128	D-1R38	123	DS12	101
CK22B	102	CQ1940BA	104	CS3710	128	D-2R38	123	DS14	102
CK22C	102	CQ11075	104	CS3711	128	D4D24	123	DS16	102
CK25	100	CQ11076	104	CS3843	128	D4D25	123	DS17	100
CK25A	100	CQ11077	104	CS3844	128	D4D26	123	DS19	100
CK26	100	CQ11110	121	CS3845	128	D7A30	128	DS21	100
CK26A	100	CQ11110A	121	CS3859	128	D7A31	128	DS22	100
CK27	100	CQ11111	121	CS3860	128	D7A32	128	DS23	100
CK27A	100	CQ11111A	121	CST1739	104	D10G1051	123	DS24	126
CK28	126	CQ11112	121	CST1740	104	D10G1052	123	DS25	100
CK28A	126	CRT1544	104	CST1741	104	D11C1B1	108	DS26	102
CK64	102	CRT1545	104	CST1742	104	D11C3B1	128	DS29	100
CK64A	102	CRT1552	104	CST1743	121	D11C5B1	108	DS34	126
CK64B	102	CRT1553	104	CST1744	121	D11C10B1	124	DS35	126
CK64C	102	CS360	123	CST1745	121	D11C11B1	124	DS36	126
CK65	102	CS1014	108	CST1746	121	D11C1F1	108	DS37	126
CK65A	102	CS1018	108	CT1122	104	D11C3F1	128	DS38	126
CK65B	102	CS1129E	128	CT1124	104	D11C5F1	108	DS41	126
CK65C	102	CS1168E	123	CT1124A	104	D11C10F1	124	DS42	126
CK66	102	CS1168F	108	CT1124B	104	D11C11F1	124	DS44	123
CK66A	102	CS1168G	123	CT1300	108	D11C201B20	123	DS45	123
CK66B	102	CS1168H	123	CT1500	108	D11C203B20	128	DS46	123
CK66C	102	CS1170F	129	CTP1104	104	D11C205B20	108	DS47	123
CK67	102	CS1225E	108	CTP1108	104	D11C210B20	124	DS51	126
CK67A	102	CS1225F	128	CTP1109	104	D11C211B20	124	DS52	126
CK67B	102	CS1226	108	CTP1111	104	D16E7	108	DS53	126
CK67C	102	CS1226E	108	CTP1117	104	D16E9	108	DS56	126
CK261	101	CS1226F	108	CTP1124	104	D16K1	108	DS62	126
CK262	101	CS1226G	108	CTP1133	121	D16K2	108	DS63	126
CK419	128	CS1227E	108	CTP1135	121	D16K3	108	DS64	126
CK422	128	CS1227F	123	CTP1136	104	D24A3394	108	DS65	126
CK474	128	CS1227G	123	CTP1137	104	D26B1	128	DS66	123
CK475	128	CS1229D	123	CTP1500	104	D26B2	128	DS67	123
CK476	108	CS1229E	128	CTP1503	104	D26C1	128	DS67W	123
CK477	108	CS1229F	128	CTP1504	104	D26E2	128	DS71	123
CK661	100	CS1229H	123	CTP1508	104	D26G1	128	DS72	123
CK662	100	CS1236D	123	CTP1509	105	D27C1	152	DS73	108
CK721	102	CS1237	129	CTP1511	121	D27C2	152	DS74	108
CK722	102	CS1238	108	CTP1512	121	D27C3	152	DS75	123
CK725	102	CS1243H	108	CTP1513	121	D27C4	152	DS76	123
CK727	102	CS1244J	108	CTP1514	121	D28A5	152	DS77	108
CK751	102	CS1245F	123	CTP1544	104	D28A6	152	DS78	108
CK754	102	CS1245G	123	CTP1545	104	D28A9	152	DS81	108
CK759	100	CS1245H	128	CTP1550	121	D28A10	152	DS83	129
CK759A	100	CS1245I	123	CTP1551	121	D28A12	152	DS85	108
CK760	100	CS1250E	128	CTP1552	104	D28A13	152	DS501	105
CK760A	102	CS1251E	129	CTP1553	104	D28D1	152	DS502	105
CK761	100	CS1255H	128	CTP1728	104	D28D2	152	DS503	104

## TRANSISTORS (cont'd)

Type To Be Replaced	Sylvania ECG Replacement	Type To Be Replaced	Sylvania ECG Replacement	Type To Be Replaced	Sylvania ECG Replacement	Type To Be Replaced	Sylvania ECG Replacement	Type To Be Replaced	Sylvania ECG Replacement
DSS504	105	E-2445	102	EA15X50	108	EN697	108	ES15X19	108
DSS505	105	E-2447	103	EA15X51	108	EN706	128	ES15X20	123
DSS506	105	E2448	102	EA15X52	108	EN708	108	ES15X23	123
DSS509	130	E2449	128	EA15X53	105	EN914	108	ES15X24	123
DSN210	104	E2450	123	EA15X54	108	EN918	108	ES15X30	108
DSN255	105	E2451	100	EA15X55	108	EN2894A	129	ES15X31	102
DSN570	105	E2452	123	EA15X56	123	EN3009	123	ES15X32	102
DT41	104	E2453	102	EA15X57	128	EN3013	123	ES15X37	123
DT80	105	E2454	123	EA15X59	123	EN3014	123	ES15X42	123
DT100	105	E2455	123	EA15X63	123	E044A	102	ES15X43	121
DT161	123	E2459	123	EA15X68	123	E065	100	ES15X45	104
DT401	104	E-2460	124	EA15X72	123	E066	100	ESA213	126
DT1040	121	E-2461	123	EA15X73	123	E067	100	ESA223	126
DT1110	128	E2462	126	EA15X75	123	E068	100	ET1	100
DT1111	128	E2464	103	EA15X76	123	E070	126	ET2	100
DT1112	128	E2465	102	EA15X77	123	E0105	100	ET3	102
DT1120	128	E2466	101	EA15X83	123	ER15X4	126	ET4	102
DT1121	128	E2467	102	EA15X84	123	ER15X5	126	ET5	102
DT1122	128	E2474	126	EA15X85	123	ER15X6	126	ET6	104
DT1311	128	E2475	126	EA15X86	123	ER15X7	102	ET7	105
DT1321	128	E2476	102	EA15X88	121	ER15X9	102	ET8	101
DT1510	128	E2477	126	EA15X94	123	ER15X10	121	ET9	101
DT1511	128	E2478	126	EA15X96	123	ER15X11	126	ET10	103
DT1512	123	E2479	126	EA15X100	130	ER15X12	126	ET11	103
DT1520	128	E2480	102	EA1080	123	ER15X13	126	ET12	103
DT1521	128	E2481	102	EA1081	102	ER15X14	126	ET15X1	102
DT1522	123	E2482	100	EA1082	121	ER15X15	126	ET15X3	108
DT1602	123	EA0081	128	EA1128	123	ER15X16	126	ET15X4	121
DT1610	123	EA0086	129	EA1129	123	ER15X17	102	ET15X5	121
DT1612	123	EA0087	129	EA1135	123	ER15X18	102	ET15X7	108
DT4110	130	EA0090	128	EA1145	123	ER15X19	126	ET15X9	108
DT4111	130	EA0091	108	EA1337	126	ER15X20	126	ET15X10	123
DT4120	130	EA0092	123	EA1338	126	ER15X21	126	ET15X11	123
DT4121	130	EA0093	108	EA1339	126	ER15X22	102	ET15X12	123
DT6110	121	EA0094	108	EA1340	126	ER15X23	102	ET15X13	123
DTG110	104	EA0095	108	EA1341	104	ER15X24	126	ET15X14	123
DTG110B	104	EA0002	126	EA1342	126	ER15X25	126	ET15X15	123
DTG1011	104	EA0007	126	EA1343	123	ER15X26	126	ET15X17	121
DTG1040	104	EA0009	126	EA1344	123	ES3	126	ET15X18	108
DT1110	104	EA0013	108	EA1345	123	ES5	101	ET15X19	108
DTG1200	121	EA0053	126	EA1346	102	ES7	104	ET15X20	123
DTG2000	121	EA15V11	126	EA1406	123	ES9	104	ET15X21	108
DTG2100	121	EA15X1	123	EA1407	123	ES10	105	ET15X23	108
DTG2200	121	EA15X2	102	EA1408	123	ES13	104	ET15X24	123
DTG2300	121	EA15X3	102	EA1451	123	ES14	126	ET15X27	123
DTG2400	121	EA15X4	102	EA1452	123	ES18	121	ET15X29	126
DU1	126	EA15X5	123	EA1499	123	ES19	102	ET15X30	108
DU2	126	EA15X6	105	EA1549	128	ES21	102	ET15X31	102
DU3	100	EA15X7	102	EA1562	108	ES23	102	ET15X32	102
DU4	102	EA15X8	102	EA1563	108	ES25	100	ET15X33	129
DU5	100	EA15X9	123	EA1564	123	ES26	100	ET15X36	128
DU6	121	EA15X10	104	EA1578	123	ES41	126	ET15X37	123
DU47	105	EA15X11	126	EA1581	128	ES46	103	ET15X38	129
E-044A	102	EA15X12	104	EA1628	123	ES501	105	ET15X39	129
E-065	126	EA15X13	126	EA1629	123	ES503	121	ET15X40	121
E-066	126	EA15X15	121	EA1630	123	ES3110	126	ET15X41	123
E-067	126	EA15X18	123	EA1684	128	ES3111	126	ET15X42	123
E-068	126	EA15X19	102	EA1696	128	ES3112	126	ET15X43	104
E-070	102	EA15X20	123	EA1697	128	ES3113	126	ET15X45	123
E-102	126	EA15X22	123	EA1698	128	ES3114	126	ET1511	102
E-105	126	EA15X23	102	EA1700	121	ES3115	126	ETS-003	130
E-132	126	EA15X24	123	EA1703	128	ES3116	126	ETT-CDC-12000	123
E-158	102	EA15X25	102	EA1716	128	ES3120	126	ETX18	123
E-241	100	EA15X26	121	EA1718	128	ES3121	126	EU15X1	108
E-214A	102	EA15X27	126	EA1733	123	ES3122	126	EU15X2	108
E-241B	102	EA15X28	102	EA1735	128	ES3123	126	EU15X27	128
E-2412	100	EA15X30	126	EA1740	130	ES3124	126	EU15X34	128
E-2427	103	EA15X31	123	EA1778	128	ES3125	126	EX15X25	102
E-2428	103	EA15X33	121	EAI-380	152	ES3126	126	F20-1001	108
E-2429	103	EA15X35	121	EBO001	102	ES15X1	102	F20-1002	108
E-2430	123	EA15X36	102	EBO003	102	ES15X4	102	F20-1003	108
E-2431	123	EA15X37	123	ED51	126	ES15X7	123	F20-1004	108
E-2434	108	EA15X38	121	ED52	100	ES15X8	100	F20-1005	108
E-2435	108	EA15X40	126	ED53	100	ES15X10	123	F20-1006	102
E-2436	123	EA15X41	126	ED54B	100	ES15X11	123	F20-1007	102
E-2438	126	EA15X43	126	ED55	102	ES15X12	123	F20-1008	102
E-2439	126	EA15X44	123	ED56	102	ES15X14	123	F20-1009	102
E-2440	126	EA15X45	108	ED57	102	ES15X16	123	F67E	121
E-2441	128	EA15X48	108	EK136	102	ES15X17	121	F215-1001	108
E-2444	123	EA15X49	108	EK159	100	ES15X18	108	F215-1002	108

TRANSISTORS (cont'd)

Type To Be Replaced	Sylvania ECG Replacement	Type To Be Replaced	Sylvania ECG Replacement	Type To Be Replaced	Sylvania ECG Replacement	Type To Be Replaced	Sylvania ECG Replacement	Type To Be Replaced	Sylvania ECG Replacement
F215-1003	108	FS1974	123	GC463	103	GER-A-D	126	GME4001	108
F215-1004	108	FS2299	126	GC464	102	GET103	102	GME4002	108
F215-1005	108	FSE1001	108	GC465	103	GET113	102	GME4003	108
F215-1006	102	FSE3001	108	GC466	102	GET113A	102	GME6001	108
F215-1007	102	FSE5002	108	GC467	103	GET114	102	GME6002	108
F215-1008	102	FSP-1	108	GC520	102	GET572	121	GME6003	108
F215-1009	102	FSP-42	108	GC521	102	GET571	126	GME9001	108
F302-1	123	FSP-42-1	108	GC532	100	GET672	126	GME9002	108
F302-2	123	FSP-164	108	GC591	102	GET672A	126	GME9001	108
F302-1532	123	FSP-165	108	GC552	102	GET673	126	GME9022	108
F302-2532	123	FSP-166	108	GC578	102	GET691	126	GMO375	126
F306-001	123	FSP-166-1	108	GC579	102	GET692	126	GMO376	126
F306-022	123	FSP-215	108	GC580	102	GET693	126	GMO377	126
F2427	108	FSP-242-1	123	GC581	102	GET871	100	GP1432	121
F2443	123	FSP-270-1	108	GC588	102	GET872	100	GPT16	121
F2448	123	FSP-289-1	108	GC608	103	GET873	126	GT11	100
F2450	108	FT025	128	GC609	103	GET873A	126	GT12	100
F2584	123	FT34C	108	GC630A	103	GET874	100	GT13	100
F2633	108	FT34D	108	GC639	102	GET875	100	GT14	100
F2634	108	FT40	108	GC640	102	GET880	126	GT14H	102
F2636	108	FT45	108	GC641	121	GET881	126	GT18	102
F4706	108	FT001	102	GC680	123	GET882	100	GT20	102
F4709	128	FT002	123	GC682	102	GET883	126	GT20H	102
F15810	108	FT003	108	GC856	102	GET885	100	GT20R	102
F15835	108	FT004	108	GC864	102	GET887	126	GT1202	101
F15840	123	FT004A	108	GC1034	101	GET888	126	GT31	102
F15840-1	123	FT005	123	GC1035	101	GET889	126	GT32	102
F15841	108	FT006	123	GC1036	101	GET890	126	GT33	102
FB401	126	FT008	123	GC1092	126	GET891	126	GT34	102
FB402	126	FT008A	123	GC1093X3	123	GET892	100	GT34HV	102
FB403	126	FT015	108	GC1134	102	GET895	100	GT34S	100
FB420	102	FT026	108	GC1142	126	GET896	100	GT35	103
FB421	102	FT027	108	GC1143	102	GET897	100	GT40	126
FB440	126	FT052	123	GC1144	123	GET898	102	GT41	126
FCS1168E641	108	FT053	108	GC1146	126	GET5116	126	GT42	126
FCS1168F813	128	FT300	124	GC1148	126	GET5117	126	GT43	126
FCS1168G704	123	FT709	124	GC1149	126	GEX8	101	GT44	126
FCS1227E814	108	FT1315	108	GC1150	102	GF20	102	GT45	126
FCS1227F743	108	FT1341	108	GC1159	100	GF21	102	GT46	126
FCS1227G810	108	FT1702	106	GC1182	126	GF32	102	GT47	126
FCS1229G	123	FT1746	106	GC1183	102	GFT44	100	GT66	126
FCS9014B	108	FV914	108	GC1186	102	GFT45	100	GT74	102
FCS9016F	108	FV918	108	GC1187	102	GFT3008/40	102	GT75	102
FCS9066	108	FV2369A	108	GC1302	100	G11	100	GT81	102
FE100	133	FV2484	108	GC4022	100	G12	102	GT81H	102
FE100A	133	FV2747C	100	GC4045	121	G13	126	GT81HS	102
FE102	134	FV2894	106	GC4062	102	G14	102	GT81R	102
FE102A	133	FV3014	108	GC4097	121	G15	101	GT82	102
FE104A	133	FV3299	108	GC4144	102	G16	101	GT83	100
FE400	133	FV3300	108	GC4267-2	121	G17	101	GT87	100
FE402	133	G11	100	GC5000	102	G18	103	GT88	100
FE402A	133	G12	102	GE-1	100	G19	121	GT109	102
FE404A	133	G13	126	GE-2	102	G10	105	GT109R	102
FF400	133	G14	102	GE-3	104	G12711	123	GT122	102
FK914	108	G19	121	GE-4	105	G12921	123	GT123	102
FK918	108	G110	105	GE-5	101	G12922	123	GT132	102
FK2369A	108	G101079	101	GE-6	101	G13708	123	GT153	100
FK2484	108	GA52829	100	GE-7	101	G13709	123	GT167	103
FK2894	106	GA53149	100	GE-8	103	G13710	123	GT210H	102
FK3014	108	GA53242	100	GE-9	126	GM0290	100	GT222	102
FK3299	108	GA53270	101	GE-10	123	GM0378	100	GT229	101
FK3300	108	GC60	100	GE-11	108	GM0380	108	GT269	100
FM4708	108	GC61	100	GE-12	124	GM290	100	GT336	103
FM709	108	GC148	103	GE-13	121MMP	GM290A	100	GT364	103
FM720A	108	GC181	100	GE-14	130	GM308	108	GT365	103
FM870	108	GC182	100	GE-15	130MPP	GM378	100	GT366	103
FM871	108	GC282	126	GE-16	121	GM378A	102	GT751	102
FM910	108	GC283	126	GE-17	128	GM380	108	GT758	102
FM911	108	GC284	126	GE-18	128	GM428	121	GT759	100
FM914	108	GC285	103	GE-19	130	GM656A	100	GT759R	100
FM1613	108	GC286	103	GE-20	128	GM770	108	GT760	100
FM1711	108	GC343	102	GE-21	129	GM E0404	106	GT760R	100
FM1893	108	GC360	100	GE-22	129	GM E0404-1	106	GT761	100
FM2368	108	GC408	102	GE-23	152	GM E0404-2	106	GT761R	100
FM2369	108	GC452	101	GE-24	152(2)	GM E1001	128	GT762	100
FM2846	108	GC453	101	GE-25	127	GME1002	108	GT762R	100
FM2894	106	GC454	101	GE-26	153	GME2001	128	GT763	102
FM3014	108	GC460	126	GE-208	126	GME2002	108	GT764	100
FS1221	123	GC461	126	GE-FET-1	133	GME3001	108	GT766	100
FS1331	128	GC462	126	GER-A	102	GME3002	108	GT766A	102

## TRANSISTORS (cont'd)

Type To Be Replaced	Sylvania ECG Replacement	Type To Be Replaced	Sylvania ECG Replacement	Type To Be Replaced	Sylvania ECG Replacement	Type To Be Replaced	Sylvania ECG Replacement	Type To Be Replaced	Sylvania ECG Replacement
GT792	101	HA5002	101	HEP233	105	HF6	108	HR-18	123
GT832	100	HA5003	101	HEP234	127	HF6H	100	HR-18A	123
GT903	103	HA5005	101	HEP235	127	HF6M	126	HR-19	123
GT904	101	HA5009	101	HEP240	124	HF7	108	HR-19A	123
GT905	101	HA5011	101	HEP242	129	HF8	108	HR-20	126
GT905R	103	HA5012	101	HEP243	128	HF9	128	HR-20A	126
GT947	101	HA5014	101	HEP245	152	HF10	129	HR-21	126
GT948	101	HA5016	101	HEP246	153	HF12H	126	HR-21A	126
GT948R	101	HA5020	101	HEP247	130	HF12M	126	HR-22	126
GT949	103	HA5021	101	HEP250	102	HF12N	126	HR-22A	126
GT949R	103	HA5022	101	HEP251	102	HF20H	126	HR-22B	126
GT1200	101	HA5023	101	HEP252	100	HF20M	126	HR-24	126
GT1223	102	HA5024	101	HEP253	100	HF50H	126	HR-24A	126
GT1604	100	HA5025	101	HEP254	102	HF50M	126	HR-25	126
GT1605	100	HA5026	101	HEP280	102	HJ-15	102	HR-25A	126
GT1606	100	HA7520	106	HEP281	100	HJ-15D	126	HR-26	126
GT1607	100	HA7522	106	HEP300	122	HJ-17	102	HR-26A	126
GT1608	101	HA7523	106	HEP302	122	HJ-17D	102	HR-27	126
GT1609	101	HA7526	106	HEP623	121	HJ-22	100	HR-27A	126
GT1644	106	HA7527	106	HEP624	121	HJ-22D	100	HR28	128
GT1658	103	HA7530	129	HEP625	127	HJ-23	100	HR-30	102
GT1665	102	HA7531	129	HEP626	127	HJ-23D	100	HR-36	123
GT2693	100	HA7532	106	HEP627	127	HJ-32	126	HR-38	123
GT2694	100	HA7533	106	HEP628	127	HJ-34	126	HR-39	102
GT2695	100	HA7536	106	HEP629	102	HJ-34A	126	HR40	126
GT2696	102	HA7537	106	HEP630	102	HJ-35	104	HR42	126
GT2765	101	HA7597	106	HEP631	102	HJ-37	100	HR43	126
GT2766	101	HA7598	106	HEP632	102	HJ-41	100	HR44	126
GT2767	101	HA7599	106	HEP633	102	HJ-43	102	HR45	126
GT2768	103	HA7630	129	HEP634	102	HJ-50	126	HR46	126
GT2883	102	HA7631	129	HEP635	100	HJ-51	126	HR-47	123
GT2884	101	HA7632	129	HEP636	100	HJ-54	100	HR-48	123
GT2885	102	HA7730	106	HEP637	100	HJ-55	126	HR50	126
GT2886	101	HA7732	106	HEP638	100	HJ-56	126	HR51	126
GT2887	102	HA7806	106	HEP639	126	HJ-57	126	HR52	126
GT2888	101	HA7807	106	HEP640	126	HJ-60	100	HR53	102
GT2906	101	HA7808	129	HEP641	101	HJ-60A	100	HR-101	104
GT5116	126	HA9048	106	HEP704	130	HJ-60C	100	HR-101A	121
GT5117	126	HA9049	106	HEP706	128	HJ-62	100	HR103	121
GT5148	102	HB-00054	102	HEP708	106	HJ-70	126	HR103A	121
GT5149	102	HB-00056	102	HEP709	108	HJ-71	100	HR105	121
GT5151	126	HB32	102	HEP710	129	HJ-72	100	HR105A	121
GT5153	126	HB33	102	HEP711	128	HJ-73	100	HR105B	121
GT1E1	100	HB54	102	HEP712	128	HJ-74	100	HSS	102
GTE2	100	HB55	102	HEP713	128	HJ-226	100	HS-15	102
GTV	100	HB75	102	HEP714	128	HJ-228	100	HS-17D	102
GTX2001	121	HB77	102	HEP715	129	HJ-230	100	HS-22D	102
H10	102	HB171	102	HEP716	106	HJ-315	102	HS-23D	102
H12	105	HB172	102	HEP717	129	HJ-606	100	HS-29D	102
H12A	105	HB175	102	HEP718	108	HJX2	100	HS-102	102
H1567	123	HB176	102	HEP719	108	HM-00049	100	HS-170	102
HA00052	100	HB178	102	HEP720	108	HM-08014	102	HT-100	106
HA00053	100	HB186	102	HEP721	128	HO300	127	HT-101	106
HA12	126	HB187	102	HEP722	128	HR-1	102	HT400	128
HA15	100	HB263	102	HEP723	128	HR-2	102	HT401	128
HA49	100	HC-00730	101	HEP724	128	HR-2A	102	HT102341B	126
HA52	100	HC-01820	123	HEP725	128	HR-3	102	HT102341C	126
HA53	100	HC-01830	108	HEP726	128	HR-4	100	HT102351A	126
HA54	102	HC206	108	HEP727	128	HR-4A	100	HT103501A	126
HA56	102	HC454	108	HEP728	128	HR-5	100	HT200771B	126
HA70	126	HC460	108	HEP729	128	HR-6	100	HT304581B	123
HA102	100	HC461	108	HEP730	128	HR-7	100	HT304581C	123
HA103	126	HC515	124	HEP731	128	HR-7A	102	HV12	102
HA104	126	HC645	108	HEP732	128	HR-8	100	HV15	102
HA201	126	HC829	108	HEP733	128	HR-8A	100	HV16	102
HA235	126	HEP1	126	HEP734	128	HR-9	100	HV17	100
HA330	100	HEP3	126	HEP735	128	HR-9A	100	HV17B	102
HA342	126	HEP50	128	HEP736	128	HR-11	123	HV19	102
HA350	126	HEP51	129	HEP737	128	HR-11A	123	HV23	123
HA1040	126	HEP52	129	HEP738	128	HR-11B	123	HV23F	123
HA1350	102	HEP53	123	HEP739	129	HR-13	123	HV25	123
HA1360	102	HEP54	123	HEP801	133	HR-13A	123	IE-850	123
HA2001	133	HEP55	108	HEP802	132	HR-14	123	IF-65	102
HA2010	133	HEP56	108	HF1	108	HR-14A	123	IG-100	105
HA2190	126	HEP57	106	HF2	108	HR-15	123	IR1601	122
HA3210	126	HEP200	104	HF3	108	HR-15A	123	IR1602	122
HA3480	126	HEP201	105	HF3H	126	HR-16	123	IR1772	122
HA3670	126	HEP230	121	HF3M	100	HR-16A	123	IR1774	122
HA4400	126	HEP231	105	HF4	108	HR-17	123	IRFE-100	133
HA5001	101	HEP232	121	HF5	108	HR-17A	123	ISD-162	103

TRANSISTORS (cont'd)

Type To Be Replaced	Sylvania ECG Replacement	Type To Be Replaced	Sylvania ECG Replacement	Type To Be Replaced	Sylvania ECG Replacement	Type To Be Replaced	Sylvania ECG Replacement	Type To Be Replaced	Sylvania ECG Replacement
J5062	126	M65B	106	M4463	121	M4730	127	MA882	102
J5063	102	M65C	106	M4464	123	M4732	128	MA883	102
J5064	102	M65D	106	M4465	123	M4733	128	MA884	102
J24561	108	M65E	106	M4466ORN	102	M4734	128	MA885	100
J24562	108	M65F	106	M4468BRN	102	M4737	123	MA886	100
J24563	108	M76	126	M4469RED	102	M4739	123	MA887	102
J24564	123	M77	126	M4470ORN	102	M4745	106	MA888	102
J24565	123	M78	126	M4471YEL	102	M4756	108	MA889	102
J24566	124	M78BLK	100	M4472GRN	102	M4757	108	MA890	100
JC100	105	M78RED	100	M4473	102	M4765	123	MA891	100
JEM-1	105	M78YEL	100	M4474YEL	102	M4767	121	MA892	100
JEM-2	105	M78GRN	100	M4475GRN	102	M4768	123	MA893	100
JEM-3	105	M84	121	M4476BLU	102	M4789	108	MA894	100
JEM-4	105	M84B	127	M4477PUR	102	M4815	128	MA895	100
JEM-5	105	M91A	128	M4478	129	M4819	129	MA896	100
JP40	104	M91B	128	M4484	100	M4820	108	MA897	100
JR5	106	M91B GRN	128	M4485	100	M4821	108	MA898	100
JR10	126	M91C	108	M4486	100	M4825	108	MA899	100
JR15	100	M91CM624	123	M4501	126	M4826	108	MA900	100
JR30	126	M91D	128	M4509	126	M4834	123	MA901	100
JR30X	126	M91E	128	M4510	102	M4837	108	MA902	100
JR40	104	M91F	128	M4545	126	M4838	123	MA903	100
JR100	126	M91FM624	123	M4545BLU	126	M4840	108	MA904	100
JR200	126	M100	133	M4545WHT	126	M4840A	108	MA909	102
K04774	104	M101	133	M4553BRN	102	M4841	123	MA910	102
K2001	108	M108	102	M4553RED	102	M4842	128	MA1318	102
K2501	107	M351	126	M4553ORN	102	M4842A	123	MA1702	100
K2502	107	M501	121	M4553YEL	102	M4843	123	MA1703	102
K2503	107	M652/PIC	128	M4553GRN	102	M4844	108	MA1704	100
K2509	107	M735RED	128	M4553BLU	102	M4845	108	MA1705	100
K4002	107	M774ORN	128	M4553PUR	102	M4852	128	MA1706	102
KD2101	102	M775BRN	128	M4562	105	M4853	108	MA1707	100
KD2102	123	M776GRN	128	M4563	102	M4854	128	MA1708	102
KGS100	100	M779BLU	128	M4564	102	M4855	108	MA4670	121
KT1017	121	M780WHT	128	M4565	102	M4857	108	MAS20	126
KV1	102	M783RED	128	M4567	102	M4872	124	MAS21	126
KV2	102	M784ORN	128	M4570	101	M4882	130	MAS22	126
KV4	102	M785YEL	128	M4573	125	M4885	124	MAS23	126
L5021	102	M786	128	M4582BRN	127	M4888A	121	MC101	126
L5022	102	M787BLU	128	M4583RED	121	M4888B	121	MC103	126
L5022A	102	M791	128	M4584GRN	121	M4898	123	MD420	102
L5025	102	M818WHT	128	M4586	126	M8014	100	MD501	102
L5025A	102	M822	123	M4588	126	M8062A	102	MD501B	102
L5108	126	M822A	123	M4590	106	M8062B	102	MDS31	102
L5121	126	M822A BLU	128	M4594	123	M8062C	102	MDS32	102
L5122	126	M822B	123	M4595	126	M8105	123	MDS33	102
L5181	126	M823WHT	128	M4596	102	M8116	126	MDS33A	102
L2091241-2	126	M823B	128	M4597	105	M8120	101	MDS33C	102
L2091241-3	126	M827BRN	128	M4597 RED	105	M8124	126	MDS33D	102
LDA404	128	M828GRN	128	M4597GRN	105	M8640	102	MDS34	102
LDA405	128	M829A	106	M4603	126	M8640A	102	MDS35	126
LDA406	128	M829B	106	M4604	126	M9010	108	MDS36	100
LDA408	128	M829C	106	M4605	126	M9138	108	MDS37	126
LDA450	129	M829D	106	M4607	102	M9148	128	MDS38	102
LDS200	128	M829E	106	M4608	102	M9228	108	MDS39	102
LDS201	128	M829F	106	M4619RED	121	MA1	126	MDS40	102
LS52	104	M833	106	M4620GRN	121	MA23	102	ME0404	106
LU2N544	126	M847BLK	128	M4621	126	MA23B	102	ME0404-2	106
M1X	128	M3519	128	M4622	105	MA25	102	ME213	123
M2N168A	101	M4313	102	M4623	127	MA100	100	ME213A	123
M24A	108	M4315	102	M4624	123	MA112	100	ME216	107
M24B	108	M4331	107	M4627	102	MA113	100	ME217	107
M25	108	M4363	126	M4630	123	MA114	100	ME900	123
M25A	108	M4363ORN	126	M4632	126	MA115	100	ME900A	123
M25B	108	M4363GRN	126	M4648	128	MA116	102	ME901	123
M54	123	M4363BLU	126	M4649	104	MA117	102	ME901A	123
M54A	123	M4363WHT	126	M4652	127	MA206	102	ME1001	123
M54B	123	M4364	126	M4689	128	MA240	102	ME1002	108
M54C	123	M4365	126	M4697	126	MA286	100	ME1075	128
M54BLK	128	M4366	126	M4709	108	MA287	100	ME1120	128
M54BRN	128	M4367	126	M4714	123	MA288	100	ME2001	128
M54RED	128	M4368	126	M4715	130	MA393	102	ME2002	108
M54ORN	128	M4398	102	M4722	121	MA393A	102	ME3001	108
M54YEL	128	M4442	106	M4722RED	121	MA393B	102	ME3002	108
M54GRN	128	M4450	102	M4722ORN	121	MA393C	102	ME4001	123
M54BLU	128	M4454	126	M4722YEL	121	MA393E	102	ME4002	123
M54WHT	128	M4456	126	M4722GRN	121	MA393G	102	ME4003	123
M54D	128	M4457	126	M4722BLU	121	MA393R	102	ME5001	108
M54E	128	M4459	127	M4722PUR	121	MA815	102	ME6001	128
M65A	106	M4462	102	M4727	104	MA881	100	ME6002	128

## TRANSISTORS (cont'd)

Type To Be Replaced	Sylvania ECG Replacement	Type To Be Replaced	Sylvania ECG Replacement	Type To Be Replaced	Sylvania ECG Replacement	Type To Be Replaced	Sylvania ECG Replacement	Type To Be Replaced	Sylvania ECG Replacement
ME6003	123	MM1152	102	MP3614	121	MPS6542	108	NKT202	100
ME8201	106	MM1153	102	MP3615	121	MPS6543	108	NKT203	100
ME9001	108	MM1154	102	MP3617	102	MPS6546	108	NKT204	100
ME9002	108	MM1367/2SC684	108	MP3730	127	MPS6547	108	NKT205	100
ME9021	128	MM1382	108	MP3731	127	MPS6548	108	NKT206	100
ME9022	108	MM1387	108	MPF102	132	MPS6552	123	NKT207	100
MF1161	107	MM1755	107	MPF103	133	MPS6553	123	NKT208	102
MF1162	107	MM1756	108	MPF104	133	MPS6554	123	NKT211	126
MF1163	107	MM1757	107	MPF105	133	MPS6555	123	NKT212	100
MF1164	107	MM1758	108	MPS25	121	MPS6573	123	NKT213	100
MF3304	106	MM1803	108	MPS404	129	MPS6574	123	NKT214	100
MHM1001	108	MM1941	123	MPS706	108	MPS6575	123	NKT215	100
MHM1101	108	MM1943	128	MPS834	123	MPS6576	123	NKT216	100
MHT180	105	MM1945	108	MPS918	107	MQ1	123	NKT217	100
MHT181	105	MM2483	128	MPS1097	126	MQ2	123	NKT218	100
MHT230	105	MM2484	128	MPS2711	128	MR3932	123	NKT221	126
MHT1802	105	MM2503	126	MPS2712	128	MR3933	128	NKT222	102
MHT1803	105	MM2550	100	MPS2713	128	MR3934	129	NKT222S1	100
MHT1804	105	MM2552	100	MPS2714	123	MST-10	128	NKT222S2	100
MHT1807	105	MM2554	100	MPS2715	128	MT100	108	NKT223	102
MHT1808	105	MM2894	106	MPS2716	128	MT101	108	NKT224	102
MHT1809	105	MM3000	128	MPS2894	107	MT102	108	NKT225	102
MHT2002	101	MM3726	129	MPS2923	128	MT106	108	NKT226	102
MHT2003	101	MM5000	100	MPS2924	128	MT107	108	NKT227	102
MHT2004	101	MM5001	100	MPS2925	128	MT3202	124	NKT228	102
MHT2008	101	MM5002	100	MPS2926	128	M2N168A	101	NKT231	102
MHT2009	101	MM22	121	MPS2926BRN	128	N1X	123	NKT232	102
MHT2010	101	MM23	121	MPS2926RED	128	N2XA	123	NKT242	100
MHT2305	105	MM24	104	MPS2926ORN	128	NA20	101	NKT243	126
MHT2414	128	MM25	104	MPS3392	128	NA30	103	NKT244	102
MHT2418	128	MM26	104	MPS3393	128	NKT4	100	NKT246	102
MHT4401	128	MM29	104	MPS3394	128	NKT5	100	NKT247	102
MHT4411	128	MM29GRN	121	MPS3395	128	NKT24	126	NKT249	126
MHT4412	128	MM29BLK	121	MPS3396	128	NKT25	126	NKT251	126
MHT4413	128	MM29PUR	121	MPS3397	128	NKT32	126	NKT252	126
MHT4451	128	MM29WHT	121	MPS3398	128	NKT33	126	NKT253	100
MHT4483	128	MM32	104	MPS3663	107	NKT42	126	NKT254	126
MHT4511	128	MM46	104	MPS3638	129	NKT43	126	NKT255	126
MHT4512	128	MM48	121	MPS3638A	129	NKT52	126	NKT261	100
MHT4513	128	MM49	121	MPS3639	106	NKT53	126	NKT262	126
MHT5906	152	MM52	102	MPS3640	106	NKT54	126	NKT263	100
MHT7401	128	MM53	102	MPS3646	108	NKT62	126	NKT264	126
MHT7411	128	MM53RED	102	MPS3693	128	NKT63	126	NKT265	126
MHT7412	128	MM53GRN	102	MPS3694	128	NKT64	126	NKT270	126
MHT7601	130	MM53BLU	102	MPS3702	106	NKT72	126	NKT271	126
MHT7602	130	MM60	102	MPS3703	106	NKT73	126	NKT272	126
MHT7603	130	MM61	127	MPS3704	128	NKT74	126	NKT274	126
MHT7607	130	MM63	127	MPS3705	128	NKT102	100	NKT275	126
MHT7608	130	MM64	127	MPS3706	128	NKT103	100	NKT275A	126
MHT7609	130	MM73	104	MPS3707	128	NKT104	100	NKT275E	126
MHT9001	128	MM73BLK	104	MPS3708	128	NKT105	100	NKT275J	126
MHT9002	128	MM73WHT	104	MPS3709	128	NKT106	100	NKT278	126
MHT9004	128	MM194	127	MPS3710	128	NKT107	100	NKT303	102
MHT9005	128	MM500	105	MPS3711	128	NKT108	102	NKT308	102
MHT18010	105	MM500A	105	MPS3721	128	NKT109	100	NKT401	121
MJ480	130	MM501	105	MPS3826	128	NKT121	126	NKT402	121
MJ481	130	MM501A	105	MPS3827	128	NKT122	126	NKT403	121
MJ2251	124	MM502	105	MPS6507	108	NKT123	126	NKT404	121
MJ2252	124	MM502A	105	MPS6511	108	NKT124	126	NKT405	121
MJ2800	130	MM504	105	MPS6512	128	NKT125	126	NKT415	121
MJ2801	130	MM504A	105	MPS6513	128	NKT126	126	NKT416	121
MJ3201	124	MM505	105	MPS6514	108	NKT127	126	NKT450	121
MJ3202	124	MM505A	105	MPS6515	128	NKT128	126	NKT451	121
MJ4101	130	MM506	105	MPS6516	129	NKT129	100	NKT452	121
MJ5202	124	MM506A	105	MPS6517	129	NKT131	126	NKT452S1	121
MJ5203	124	MM507	105	MPS6518	106	NKT132	126	NKT453	121
MJ5204	124	MM507A	105	MPS6519	106	NKT133	126	NKT454	121
MJE370	153	MM525	121	MPS6520	128	NKT141	126	NKT501	121
MJE371	153	MM2060	121	MPS6521	108	NKT142	126	NKT503	121
MJE520	152	MM2601	121	MPS6522	106	NKT143	126	NKT504	121
MJE521	152	MM2062	121	MPS6523	106	NKT144	126	NKT618	126
MM486	128	MM2137A	121	MPS6528	128	NKT151	126	NKT675	126
MM487	128	MM2138A	121	MPS6530	128	NKT152	126	NKT676	126
MM488	128	MM2139A	121	MPS6531	128	NKT153/25	126	NKT677	126
MM511	128	MM2142A	121	MPS6532	128	NKT154/25	126	NKT701	103
MM512	128	MM2143A	121	MPS6533	106	NKT162	126	NKT703	103
MM513	128	MM2144A	121	MPS6534	106	NKT163	126	NKT713	103
MM709	108	MM3611	121	MPS6535	106	NKT163/25	102	NKT717	101
MM1139	100	MM3612	121	MPS6539	108	NKT164	126	NKT734	101
MM1151	102	MM3613	121	MPS6541	108	NKT164/25	126	NKT736	101



TRANSISTORS (cont'd)

Type To Be Replaced	Sylvania ECG Replacement	Type To Be Replaced	Sylvania ECG Replacement	Type To Be Replaced	Sylvania ECG Replacement	Type To Be Replaced	Sylvania ECG Replacement	Type To Be Replaced	Sylvania ECG Replacement
NKT751	103	OC26	104	OC306-3	126	P1C	129	PQ30	126
NKT752	103	OC27	104	OC307	126	P1D	129	PQ31	122
NKT753	101	OC28	104	OC307-1	126	P1G	121	PRC10A	121
NKT773	103	OC29	104	OC307-2	126	P1H	129	PRC15A	122
NKT7781	101	OC30	131	OC307-3	126	P1J	129	PRC20A	122
NPC115	128	OC30A	131	OC308	126	P1K BLK	121	Power 12	121
NPC187	128	OC30B	131	OC309	102	P1K BRN	121	Power 25	121
NPC189	128	OC34	102	OC309-1	100	P1K RED	121	Power 40	105
NR5	101	OC35	104	OC309-2	100	P1K ORN	121	Power 60	105
NR10	101	OC36	104	OC309-3	100	P1K YEL	121	Power 80	105
NR20	103	OC38	102	OC318	102	P1K GRN	121	Power 99	121
NR30	101	OC41	100	OC330	102	P1K BLU	121	Power 299	121
NS381	108	OC42	126	OC331	126	P1L	126	PS-1	121
NS382	108	OC43	126	OC340	102	P1L/4956	126	PT2A	126
NS404	129	OC44	100	OC341	102	P1N	106	PT2S	126
NS475	108	OC45	100	OC342	126	P1N-1	106	PT3	121
NS476	108	OC46	126	OC343	126	P1N-2	106	PT3A	121
NS477	108	OC47	102	OC350	102	P1N-3	106	PT3B	121
NS478	128	OC53	102	OC351	126	P1P	129	PT12	121
NS479	128	OC54	102	OC360	102	P1P-1	129	PT25	121
NS480	108	OC55	102	OC361	126	P1R	121	PT30	121
NS661	106	OC56	102	OC362	126	P1V	153	PT40	102
NS662	106	OC57	126	OC363	126	P1W	106	PT50	102
NS663	106	OC58	126	OC364	102	P1Y	127	PT150	104
NS664	106	OC59	126	OC390	126	P2A	106	PT155	121
NS665	106	OC60	126	OC410	100	P2D BRN	121	PT176	121
NS666	106	OC65	126	OC430	106	P2D RED	121	PT234	121
NS667	106	OC66	126	OC430K	106	P2D ORN	121	PT235	121
NS668	106	OC70	126	OC440	106	P2D GRN	121	PT235A	104
NS731	108	OC71	126	OC440K	106	P2K	153	PT236	104
NS731A	108	OC71A	102	OC443	106	P3139	130	PT236A	104
NS732	108	OC71N	102	OC443K	106	P5152	123	PT236B	121
NS732A	108	OC72	102	OC445	106	P5153	123	PT236C	121
NS733	108	OC73	102	OC449	106	P8890	121	PT242	121
NS733A	108	OC74	102	OC450	106	P8890A	121	PT250	105
NS734	108	OC75	102	OC460	106	P31898	121	PT255	121
NS734A	108	OC75N	102	OC460K	106	P75534	121	PT256	121
NS949	128	OC76	102	OC463	106	PA1000	106	PT285	121
NS1000	106	OC77	102	OC463K	106	PA1001	106	PT285A	121
NS1001	106	OC77M	102	OC465	106	PA10889-1	102	PT301	121
NS1356	108	OC79	102	OC465K	106	PA10889-2	102	PT301A	121
NS1500	107	OC80	102	OC466	106	PA10890	104	PT307	102
NS1510	107	OC81	102	OC466K	106	PA10890-1	121	PT307A	121
NS1672	129	OC81D	102	OC467	106	PADT20	126	PT501	105
NS1673	129	OC81DD	102	OC467K	106	PADT21	126	PT515	105
NS1674	129	OC83	126	OC468	106	PADT22	126	PT530	100
NS1861	129	OC84	126	OC468K	106	PADT23	126	PT530A	100
NS1862	129	OC122	102	OC469	106	PADT24	126	PT554	104
NS1863	129	OC123	126	OC469K	106	PADT25	126	PT555	121
NS1864	129	OC130	100	OC470	106	PADT26	126	PT612	128
NS1972	108	OC139	101	OC470K	106	PADT27	126	PT627	123
NS1973	108	OC140	101	OC502	102	PADT28	126	PT703	123
NS1974	108	OC141	101	OC602SQ	102	PADT30	126	PT720	121
NS1975	108	OC169	126	OC603	102	PADT31	126	PT850	128
NS2100	128	OC169R	126	OC604	102	PADT35	126	PT850A	128
NS2101	128	OC170	126	OC604SP	102	PADT40	126	PT851	123
NS3039	107	OC170R	126	OC612	126	PADT50	104	PT855	126
NS3040	107	OC170V	126	OC613	126	PADT51	126	PT856	126
NS3041	107	OC171	126	OC614	126	PAR12	121	PT886	123
NS3300	108	OC171R	126	OC615	126	PB110	121	PT887	128
NS6062	106	OC171V	126	OC700	106	PBE3014-1	102	PT888	128
NS6063	106	OC200	106	OC700A	106	PBE3014-2	102	PT896	128
NS6064	106	OC201	106	OC700B	106	PBE3020-1	102	PT897	128
NS6065	106	OC202	106	OC702	106	PBE3020-2	103	PT898	128
NS9400	128	OC203	106	OC702A	106	PBE3162	102	PT1558	128
NS9420	128	OC204	106	OC702B	106	PEP2	128	PT1559	128
NS9500	128	OC205	129	OC704	106	PEP-5	108	PT1610	128
NS9540	128	OC206	106	OC711	102	PEP-6	108	PT1835	128
NS9710	108	OC207	129	OC740	106	PEP-7	108	PT1836	128
NS9728	128	OC303	126	OC740G	129	PEP-8	108	PT1837	128
NS9729	128	OC304	102	OC740M	106	PEP9	128	PT1941	130
NS9730	128	OC304-1	126	OC740Q	106	PEP1001	128	PT2040A	123
NS9731	128	OC304-2	126	OC742	106	PEP2001	128	PT2760	123
OC16	104	OC304-3	126	OC742G	129	PET4001	128	PT3141	123
OC19	121	OC305	126	OC742M	106	PET9021	128	PT3141A	123
OC20	121	OC305-1	126	OC742O	106	PET9022	128	PT3501	123
OC22	104	OC305-2	126	OF129	102	PMT1767	108	PT3151A	108
OC23	104	OC306	126	ON174	126	QQ27	126	PT3151B	128
OC24	104	OC306-1	102	P1A	121	QQ28	102	PT3151C	128
OC25	104	OC306-2	126	P1B	102	QQ29	102	PT3500	128

## TRANSISTORS (cont'd)

Type To Be Replaced	Sylvania ECG Replacement	Type To Be Replaced	Sylvania ECG Replacement	Type To Be Replaced	Sylvania ECG Replacement	Type To Be Replaced	Sylvania ECG Replacement	Type To Be Replaced	Sylvania ECG Replacement
PT3502	128	R227	100	RS1547	101	RS3867	100	RS5552	102
PT4800	123	R242	102	RS1548	102	RS3868	126	RS5553	102
PT4816	107	R244	100	RS1549	103	RS3880	102	RS5554	102
PT4830	107	R255	102	RS1550	100	RS3892	100	RS5556	102
PTO-6	121	R258	100	RS1553	101	RS3897	102	RS5557	102
PTO139	102	R289	102	RS1554	100	RS3898	126	RS5558	102
PQ27	126	R290	102	RS1555	102	RS3900	126	RS5563	102
PQ28	102	R291	102	RS2350	102	RS3901	126	RS5564	102
PQ29	102	R324	102	RS2351	102	RS3902	126	RS5565	102
PQ30	126	R338	102	RS2352	102	RS3903	126	RS5566	102
PQ31	104	R339	102	RS2353	102	RS3904	102	RS5567	102
PXB103	102	R340	123	RS2354	102	RS3905	126	RS5568	102
PXB113	102	R341	102	RS2355	102	RS3906	126	RS5602	102
PXC101	102	R424	100	RS2356	101	RS3907	126	RS5603	102
PXC101A	102	R424-1	102	RS2359	101	RS3911	126	RS5605	102
PXC101AB	102	R425	100	RS2360	101	RS3912	126	RS5607	102
Q1-7C	102	R428	102	RS2364	101	RS3913	126	RS5608	102
Q2N406	102	R488	100	RS2365	101	RS3914	100	RS5610	102
Q2N1526	126	R497	126	RS2366	101	RS3915	100	RS5612	121
Q2N2613	102	R506	100	RS2367	102	RS3925	102	RS5613	121
Q34450	124	R515	126	RS2373	102	RS3926	102	RS5614	121
Q40359	126	R516	126	RS2374	102	RS3929	126	RS5616	121
QA-8	128	R530	100	RS2375	105	RS3931	103	RS5704	102
QA-11	129	R539	126	RS2675	102	RS3959-1	104	RS5704-2	102
QA-16	128	R558	100	RS2677	102	RS3986	126	RS5708	102
QG0074	104	R579	100	RS2679	126	RS3995	126	RS5708-2	102
QG0076	102	R592	101	RS2680	126	RS5008	102	RS5709	102
QG0254	123	R593	102	RS2683	100	RS5101	126	RS5711	102
QP-1	121	R608	102	RS2684	100	RS5102	102	RS5717	102
QP-1A	121	R608A	102	RS2685	100	RS5103	102	RS5717-1	102
QP-2	121	R684	126	RS2686	100	RS5104	100	RS5717-3	102
QP-6	121	R714	126	RS2687	100	RS5105	126	RS5717-6	102
QP-7	121	R715	126	RS2688	100	RS5106	100	RS5720	102
QP-8	130	R1273	102	RS2689	102	RS5107	126	RS5731	102
QR2378	102	R1274	102	RS2690	100	RS5108	126	RS5732	102
QSE1001	108	R1533	101	RS2691	100	RS5109	126	RS5733	102
QSE3001	108	R2444	124	RS2692	100	RS5201	126	RS5734	102
QSE5020	108	R2473	108	RS2694	100	RS5202	102	RS5735	102
QOV60526	103	R2476	108	RS2695	100	RS5203	102	RS5736	102
QOV60527	103	R2477	108	RS2696	100	RS5204	126	RS5737	102
QOV60528	102	R2749	102	RS2697	102	RS5205	126	RS5738	102
QOV60529	123	R2749M	102	RS3211	102	RS5206	126	RS5740-1	102
QOV60530	123	R2964	127	RS3275	102	RS5207	126	RS5742	102
QOV60537	103	R2982	130	RS3276	102	RS5208	126	RS5743	102
QOV60538	102	R3293	103	RS3277	100	RS5209	126	RS5743-1	102
R16	102	R4369	130	RS3278	100	RS5243-2	102	RS5743-2	102
R24-1001	102	RC1700	130	RS3279	100	RS5301	126	RS5743-3	102
R24-1002	102	RC2270	130	RS3280	102	RS5302	100	RS5744	102
R24-1003	102	RCA35953	102	RS3281	100	RS5303	100	RS5744-3	102
R24-1004	102	RCA35954	102	RS3282	102	RS5305	126	RS5745	102
R33	101	RCA40231	103	RS3283	126	RS5306	126	RS5746	102
R34	101	RR1120	123	RS3284	102	RS5311	126	RS5747	102
R35	102	RR7504	123	RS3285	102	RS5312	126	RS5748	102
R52	102	RS406	102	RS3286	102	RS5313	126	RS5749	102
R56	102	RS593	126	RS3287	100	RS5314	126	RS5750	102
R61	101	RS684	126	RS3288	100	RS5401	126	RS5751	102
R62	101	RS685	126	RS3289	102	RS5402	100	RS5753	126
R63	101	RS686	102	RS3293	102	RS5403	100	RS5753-2	126
R64	102	RS687	102	RS3299	102	RS5406	102	RS5754	126
R65	102	RS1049	123	RS3301	102	RS5502	102	RS5755	126
R66	102	RS1059	123	RS3306	101	RS5503	102	RS5756	126
R67	102	RS1192	102	RS3308	102	RS5504	100	RS5757	102
R79	101	RS1513	101	RS3309	100	RS5505	102	RS5758	126
R80	101	RS1524	103	RS3310	102	RS5506	102	RS5759	126
R83	102	RS1530	101	RS3316	102	RS5507	102	RS5760	126
R87	102	RS1531	101	RS3316-1	102	RS5511	100	RS5761	126
R98	102	RS1532	101	RS3316-2	102	RS5530	102	RS5762	126
R177	101	RS1533	103	RS3318	102	RS5531	102	RS5765	102
R119	100	RS1534	101	RS3322	126	RS5532	102	RS5766	102
R120	102	RS1536	101	RS3323	126	RS5533	102	RS5767	102
R125	101	RS1537	101	RS3324	126	RS5534	102	RS5768	102
R135	101	RS1538	101	RS3358-1	121	RS5535	102	RS5802	126
R136	101	RS1539	100	RS3717	102	RS5536	102	RS5818	126
R137	101	RS1540	102	RS3726	102	RS5540	100	RS5835	121
R152	102	RS1541	102	RS3857	102	RS5541	102	RS5851	123
R163	100	RS1542	102	RS3858-1	121	RS5542	102	RS5852	102
R164	102	RS1543	102	RS3862	126	RS5543	102	RS5853	123
R186	100	RS1544	102	RS3863	126	RS5544	102	RS5854	123
R202	101	RS1545	102	RS3864	126	RS5545	102	RS5855	121M P
R203	101	RS1546	102	RS3866	126	RS5551	102	RS5856	123

TRANSISTORS (cont'd)

Type To Be Replaced	Sylvania ECG Replacement	Type To Be Replaced	Sylvania ECG Replacement	Type To Be Replaced	Sylvania ECG Replacement	Type To Be Replaced	Sylvania ECG Replacement	Type To Be Replaced	Sylvania ECG Replacement
RS5857	123	RS7522	108	RT7515	123	S1674	108	SA411	106
RS6821	126	RS7523	108	RT7517	123	S1674A	108	SA412	106
RS6822	126	RS7525	123	RT7518	123	S1682	108	SA413	106
RS6824	100	RS7526	123	RT7528	123	S1835	123	SA414	106
RS6840	102	RS7527	123	RT7638	123	S1891	123	SA415	106
RS6846	123	RS7528	123	RT61014	100	S1891A	123	SA416	106
RS7101	108	RS7529	123	RT61015	102	S1891B	123	SA495	106
RS7102	108	RS7530	123	RT61016	102	S2020	108	SA495A	106
RS7103	123	RS7532	108	S-39T	121	S2059	124	SA496	106
RS7104	108	RS7533	108	S-40T	121	S2172	108	SA496A	106
RS7105	123	RS7542	123	S-40TB	121	S2590	123	SA496B	106
RS7106	108	RS7568	102	S-41T	121	S2617	108	SA537	106
RS7107	108	RS7606	123	S-42T	121	S3019	108	SA538	106
RS7108	108	RS7607	123	S-43T	121	S5327E	108	SA539	106
RS7109	108	RS7609	123	S-46T	121	S5328E	108	SA540	106
RS7110	108	RS7610	123	S-48T	121	S5670E	108	SAC40	106
RS7112	108	RS7611	123	S-49T	121	S15649	108	SAC40A	106
RS7113	108	RS7612	123	S-55TB	121	S15650	108	SAC40B	106
RS7114	108	RS7613	123	S-58TB	121	S15657	108	SAC42	106
RS7115	108	RS7614	123	S-70T	126	S15658	108	SAC42A	106
RS7116	123	RS7620	128	S-80T	126	S15659	108	SAC42B	106
RS7117	128	RS7622	123	S-87TB	126	S95101	126	SAC44	106
RS7118	108	RS7623	123	S-88TB	126	S95102	126	SB100	126
RS7119	108	RS7624	123	S133-1	123	S95103	126	SB168	102
RS7120	108	RS7625	123	S905	130	S95104	126	SB169	102
RS7122	108	RS7626	123	S305A	130	S95106	126	SB200	126
RS7123	108	RS7627	123	S-873TB	126	S95125	108	SB5122	126
RS7124	108	RS7628	123	S-874TB	126	S95125A	108	SC12	102
RS7125	108	RS7638	123	S1009	108	S95126	108	SC43	100
RS7126	108	RS7639	123	S1019	108	S95126A	108	SC44	100
RS7127	108	RS7665	129	S1037	108	S95201	102	SC45	102
RS7128	108	RS8406	102	S1041	108	S95202	123	SC46	100
RS7129	128	RS8407	103	S1044	108	S95203	102	SC56	103
RS7132	128	RS57433	102	S1058	108	S95204	102	SC63	102
RS7133	128	RS57042	102	S1059	108	S95206	102	SC65	123
RS7135	128	RS57062	102	S1060	108	S95207	102	SC66	102
RS7136	123	RT141	128	S1061	123	S95214	102	SC68	102
RS7138	108	RT154	128	S1062	108	S95253	121	SC69	102
RS7142	108	RT185	102	S1065	123	S95253-1	121	SC70	121
RS7144	123	RT188	128	S1066	123	S99101	126	SC71	126
RS7201	108	RT482	128	S1068	123	S99102	126	SC72	126
RS7202	108	RT483	128	S1069	123	S99103	126	SC73	102
RS7209	108	RT484	128	S1076	123	S99104	126	SC74	126
RS7210	108	RT929H	123	S1078	123	S99201	102	SC78	126
RS7212	108	RT930H	123	S1079	123	S99203	102	SC79	126
RS7215	108	RT2016	123	S1080	123	SA7	101	SC80	126
RS7217	108	RT2329	102	S1128	123	SA29	102	SC727	124
RS7218	108	RT2330	102	S1142	108	SA50	106	SC777	124
RS7219	108	RT2331	102	S1143	108	SA51	106	SC832	123
RS7220	108	RT2332	123	S1153	108	SA52	106	SC4004	124
RS7311	124	RT2709	102	S1221	123	SA52A	106	SC4044	123
RS7312	124	RT2914	123	S1221A	123	SA52B	106	SC4131	124
RS7315	124	RT2915	108	S1227	108	SA53	106	SC4131-1	124
RS7316	124	RT3063	128	S1245	123	SA54	106	SC4167	124
RS7317	124	RT3064	123	S1276	108	SA55	106	SC4244	124
RS7318	124	RT3065	128	S1286	108	SA56	106	SCR02C	122
RS7320	124	RT3069	108	S1296	108	SA70	106	SDD420	123
RS7321	124	RT3070	108	S1313	108	SA128	102	SDD421	128
RS7327	124	RT3071	129	S1316	108	SA197	102	SDD820	108
RS7328	124	RT3095	108	S1317	108	SA197-1	102	SDD821	108
RS7329	124	RT3096	103	S1318	108	SA197-2	102	SDD1220	128
RS7330	124	RT3097	102	S1331	123	SA197-3	102	SDD3000	102
RS7407	123	RT3098	102	S1331N	123	SA204	102	SDT9201	130
RS7408	123	RT3361	126	S1331W	123	SA205BRN	102	SE504	108
RS7410	123	RT3362	126	S1348	102	SA205RED	102	SE1001	108
RS7411	123	RT3363	102	S1349	102	SA205ORN	102	SE1002	123
RS7412	123	RT3364	102	S1360	108	SA205YEL	102	SE1010	123
RS7413	123	RT3365	102	S1361	108	SA205GRN	102	SE1019	108
RS7504	123	RT3565	123	S1362	108	SA205BLU	102	SE1044	108
RS7510	128	RT3566	102	S1363	123	SA205PUR	102	SE1331	123
RS7511	123	RT3567	123	S1364	123	SA205WHT	102	SE1419	108
RS7512	108	RT5151	128	S1369	123	SA240	102	SE2001	123
RS7513	123	RT5152	128	S1403	108	SA310	106	SE2002	128
RS7514	108	RT5230	129	S1408	108	SA311	106	SE3001	108
RS7515	108	RT5401	128	S1409	108	SA312	106	SE3002	108
RS7516	123	RT5402	128	S1559	123	SA313	106	SE3019	108
RS7517	108	RT5403	128	S1570	123	SA314	106	SE3030	130
RS7518	123	RT5404	128	S1629	123	SA315	106	SE3031	130
RS7519	128	RT7511	123	S1639	102	SA316	106	SE3032	130
RS7520	108	RT7514	123	S1640	126	SA410	106	SE3033	130

## TRANSISTORS (cont'd)

Type To Be Replaced	Sylvania ECG Replacement	Type To Be Replaced	Sylvania ECG Replacement	Type To Be Replaced	Sylvania ECG Replacement	Type To Be Replaced	Sylvania ECG Replacement	Type To Be Replaced	Sylvania ECG Replacement
SE3035	130	SFT268	126	SJE277	153	SP62	127	SPS43-1	128
SE3036	130	SFT288	126	SJE278	152	SP148-3	121	SPS1097	129
SE4001	123	SFT298	101	SJE279	153	SP334	121	SPS1523	106
SE4002	123	SFT306	126	SJE280	152	SP404T	121	SPS3003	108
SE4010	123	SFT307	126	SJE305	152	SP441	121	SPS3015	128
SE5001	108	SFT308	126	SJE340	152	SP441D	104	SPS3724	106
SE5002	108	SFT315	126	SJE408	153	SP441G	121	SPS3735	128
SE5003	108	SFT316	126	SJE721	152	SP441S	104	SPS3900	128
SE5004	108	SFT317	126	SJE736	153	SP485	121	SPS3907	128
SE5006	108	SFT318	126	SJE737	152	SP485B	121	SPS3908	128
SE5020	108	SFT319	126	SJE769	152	SP485W	104	SPS3909	128
SE5021	108	SFT320	126	SJE797	153	SP485BLK	121	SPS3923	128
SE5022	108	SFT321	100	SJE799	153	SP485BRN	121	SPS3924	129
SE5023	108	SFT322	102	SJE1518	153	SP485BLU	121	SPS3925	128
SE5024	108	SFT323	100	SJE1519	152	SP485WHT	121	SPS3926	128
SE5025	108	SFT327	102	SJE1520	152	SP486WHT	121	SPS3927	129
SE5050	108	SFT337	126	SK7	101	SP486	104	SPS3929	128
SE5051	128	SFT351	100	SK1856	106	SP486W	121	SPS3930	108
SE6001	123	SFT352	102	SK2604	106	SP634	121	SPS3931	106
SE6002	123	SFT353	102	SK3003	102	SP649	121	SPS3936	128
SE6006	128	SFT354	126	SK3004	102	SP649-1	121	SPS3937	128
SE7001	123	SFT357	126	SK3005	100	SP834	121	SPS3938	128
SE7002	128	SFT357P	100	SK3006	126	SP875	121	SPS3940	128
SE7005	128	SFT358	126	SK3007	126	SP880	104	SPS3948	128
SE7006	124	SFT377	101	SK3008	126	SP880-1	121	SPS3951	128
SE7020	124	SFT440	128	SK3009	121	SP880-3	121	SPS3952	128
SE7030	124	SFT443	128	SK3010	103	SP891	104	SPS3957C	128
SE8001	128	SFT443A	101	SK3011	101	SP891B	121	SPS3967	128
SE8002	128	SFT445	128	SK3012	105	SP891W	104	SPS3968	128
SE8010	128	SFT526	100	SK3013	104MP	SP891BLU	121	SPS3971	128
SE40022	121	SFT713	128	SK3014	121	SP891G	121	SPS3972	128
SE50399	127	SFT714	123	SK3015	121MP	SP891GRN	121	SPS3973	128
SEC1078	128	SJ130	124	SK3015	104	SP891WHT	121	SPS3987	129
SEC1079	128	SJ570	123	SK3018	108	SP1108	104	SPS3988	129
SEC1477	128	SJ619	130	SK3019	108	SP1137	104	SPS3990	129
SEC1479	128	SJ619-1	130	SK3020	123	SP1403	121	SPS3999	128
SF1713	103	SJ806	124	SK3021	124	SP1481-1	121	SPS4002	108
SF1714	103	SJ1165	124	SK3024	128	SP1481-2	121	SPS4003	128
SF1726	123	SJ1201	124	SK3025	129	SP1481-3	104	SPS4004	128
SFT124	102	SJ1286	124	SK3026	152	SP1481-4	121	SPS4005	128
SFT125	100	SJ1470	130	SK3027	130	SP1482-2	121	SPS4006	128
SFT125P	102	SJ3604	130	SK3028	152(2)	SP1482-3	121	SPS4007	129
SFT143	100	SJ8701	130	SK3029	130MP	SP1482-4	121	SPS4008	128
SFT144	102	SJ9110	130	SK3034	127	SP1482-5	104	SPS4009	128
SFT162	100	SJE100	152	SK3035	152	SP1482-6	121	SPS4013	106
SFT163	100	SJE106	152	SK3036	130	SP1482-7	121	SPS4014	129
SFT171	100	SJE108	153	SK3037	130MP	SP1483	121	SPS4016	128
SFT172	100	SJE111	153	SK3041	152	SP1483-1	121	SPS4017	128
SFT173	100	SJE112	153	SK3960	123	SP1483-2	121	SPS4018	129
SFT174	100	SJE113	152	SK5184A	124	SP1483-3	121	SPS4019	129
SFT184	103	SJE114	153	SK5915	123	SP1484	121	SPS4020	128
SFT186	128	SJE202	153	SK7181	123	SP1550-3	121	SPS4025	106
SFT191	121	SJE203	152	SKA4129	129	SP1556	121	SPS4026	129
SFT212	121	SJE210	153	SL100	108	SP1556-1	121	SPS4027	129
SFT213	121	SJE211	152	SL200	106	SP1556-2	121	SPS4028	129
SFT214	121	SJE221	153	SL201	106	SP1556-3	121	SPS4029	128
SFT221	126	SJE222	152	SL300	123	SP1556-4	121	SPS4030	108
SFT222	100	SJE227	103	SM217	100	SP1563-2	121	SPS4031	106
SFT223	126	SJE228	152	SM2700	123	SP1603	121	SPS4032	128
SFT226	126	SJE229	152	SM2701	123	SP1603-1	121	SPS4034	128
SFT227	126	SJE237	152	SM4508-B	123	SP1603-2	121	SPS4039	128
SFT228	128	SJE241	153	SM5564	123	SP1603-3	121	SPS4040	128
SFT229	126	SJE242	152	SM5643	123	SP1651	104	SPS4041	128
SFT237	126	SJE243	153	SM6251	128	SP1742	127	SPS4042	128
SFT238	121	SJE244	152	SM7815	123	SP1950	121	SPS4043	108
SFT239	121	SJE245	153	SM7836	123	SP2072	121	SPS4044	128
SFT240	121	SJE246	152	SM9135	123	SP2076	121	SPS4045	128
SFT241	100	SJE248	152	SN60	123	SP2158	124	SPS4049	128
SFT243	100	SJE253	152	SN80	108	SP2361	127	SPS4050	108
SFT245	121	SJE257	153	SN166	128	SP8400	128	SPS4051	108
SFT251	102	SJE261	152	SN167	128	SP8401	128	SPS4052	128
SFT252	100	SJE262	152	SN2204	106	SPC40	128	SPS4053	128
SFT253	102	SJE265	153	SO1	126	SPC42	128	SPS4054	106
SFT259	101	SJE267	153	SO2	126	SPC50	128	SPS4055	128
SFT260	101	SJE271	152	SO3	126	SPC51	128	SPS4056	129
SFT261	101	SJE272	152	SO25	102	SPC52	128	SPS4059	128
SFT264	105	SJE273	153	SO65	100	SPF024	133	SPS4060	128
SFT265	105	SJE274	152	SO65A	126	SPS4	128	SPS4061	128
SFT266	105	SJE275	153	SO88	102	SPS20	128	SPS4062	128
SFT267	105	SJE276	152	SP39	127	SPS38	128	SPS4063	128

TRANSISTORS (cont'd)

Type To Be Replaced	Sylvania ECC Replacement	Type To Be Replaced	Sylvania ECC Replacement	Type To Be Replaced	Sylvania ECC Replacement	Type To Be Replaced	Sylvania ECC Replacement	Type To Be Replaced	Sylvania ECC Replacement
SPS4064	129	ST29	108	ST905	108	SYL152	123	T76	123
SPS4066	128	ST30	108	ST910	108	SYL160	100	T77	102
SPS4067	128	ST31	108	ST1026	108	SYL792	100	T78	100
SPS4068	108	ST32	108	ST1050	108	SYL1182	103	T81	100
SPS4069	128	ST33	108	ST1051	108	SYL1279	101	T82	102
SPS4072	129	ST34	108	ST1242	123	SYL1297	103	T83	100
SPS4073	106	ST35	108	ST1243	123	SYL1310	101	T84	100
SPS4074	128	ST37C	100	ST1244	123	SYL1311	101	T87	100
SPS4075	128	ST37D	100	ST1290	123	SYL1312	101	T95	100
SPS4076	129	ST37E	100	ST1336	108	SYL1313	101	T99	126
SPS4077	128	ST40	108	ST1506	128	SYL1326	101	T100	126
SPS4078	129	ST41	108	ST1607	128	SYL1327	101	T101	100
SPS4079	128	ST42	108	ST1694	108	SYL1329	103	T102A	100
SPS4080	108	ST43	108	ST3030	108	SYL1380	101	T108	100
SPS4081	128	ST44	108	ST3031	108	SYL1396	103	T109	100
SPS4082	129	ST45	108	ST6110	123	SYL1454	101	T116	100
SPS4083	128	ST50	108	ST6120	108	SYL1524	103	T126	100
SPS4084	128	ST51	108	ST6573	123	SYL1536	103	T127	121
SPS4085	128	ST53	108	ST6574	123	SYL1537	101	T129	100
SPS4086	129	ST55	108	ST8014	106	SYL1538	103	T130	100
SPS4087	129	ST56	108	ST8033	106	SYL1539	103	T139	123
SPS4088	128	ST57	108	ST8034	106	SYL1547	103	T142	121
SPS4089	128	ST58	108	ST8035	106	SYL1583	102	T143	123
SPS4090	106	ST59	108	ST8036	106	SYL1588	100	T157	123
SPS4091	128	ST60	108	ST8065	106	SYL1591	101	T158	123
SPS4095	128	ST61	108	ST8190	106	SYL1608	100	T170	123
SPS4313	128	ST62	108	ST8500	106	SYL1617	101	T171	123
SPS4314	129	ST63	108	ST8509	106	SYL1665	102	T237	123
SPS4354	106	ST64	108	STC1080	130	SYL1668	102	T255	123
SPS4355	129	ST70	108	STC1081	130	SYL1690	100	T256	123
SPS4356	128	ST71	108	STC1082	130	SYL1697	100	T257	124
SPS4363	128	ST72	108	STC1083	130	SYL1717	100	T261	124
SPS4365	128	ST80	108	STC1084	130	SYL1750	101	T339	123
SPS4367	128	ST82	108	STC4252	130	SYL1987	101	T340	129
SPS4446	128	ST106	105	STC4253	130	SYL2120	100	T342	123
SPS4450	128	ST107	105	STC4254	130	SYL2130	101	T344	152
SPS4451	128	ST108	105	STC4255	130	SYL2131	101	T348	126
SPS4452	106	ST109	105	STC5610	129	SYL2132	101	T367	126
SPS4453	128	ST110	105	STC5611	129	SYL2134	103	T368	126
SPS4455	128	ST111	105	STC5612	129	SYL2135	103	T373	126
SPS4458	106	ST112	105	STX0011	129	SYL2136	103	T374	126
SPS4459	128	ST122	102	STX0014	130	SYL2189	126	T396	153
SPS4460	129	ST123	102	STX0015	124	SYL2245	101	T399	123
SPS4472	128	ST150	123	STX0027	130	SYL2246	101	T417	123
SPS4473	129	ST151	123	STX0028	128	SYL2247	100	T811	126
SPS4476	128	ST152	123	STX0032	130	SYL2248	102	T814	102
SPS4480	129	ST153	123	STX0033	126	SYL2249	100	T815	102
SPS4610	128	ST154	123	STX0034	126	SYL2250	100	T841	130
SPS5008	129	ST155	123	STX0036	100	SYL2300	102	T842	130
SPS6109	106	ST156	123	STX0085	100	SYL2650	103	T843	130
SPS7652	128	ST157	123	STX0087	100	SYL3613	102	T844	100
SQ-7	103	ST160	123	STX0089	100	SYL4131	108	T1000	102
SR-1	102	ST161	123	STX0090	100	SYL4315	103	T1001	102
SS155	126	ST162	123	STX0096	102	T0003	100	T1003	100
SS524	128	ST163	123	STX0099	102	T0004	100	T1004	102
SS2308	128	ST172	101	STX0104	102	T0005	100	T1005	102
SS2503	129	ST175	123	STX0105	102	T0012	100	T1006	102
SSA43	129	ST176	123	STX0110	102	T0014	102	T1007	102
SSA43A	129	ST177	123	STX0114	102	T0015	100	T1008	102
SSA46	129	ST178	123	STX0121	102	T0031	100	T1010	102
SSA48	129	ST180	123	STX0123	102	T0033	100	T1011	100
ST01	123	ST181	123	STX0224	102	T0038	100	T1012	100
ST02	123	ST182	123	STX0260	102	T0039	100	T1013	103
ST03	123	ST250	123	STX0263	102	T0040	100	T1023	102
ST04	123	ST251	123	STX0264	102	T0041	102	T1028	126
ST05	123	ST301	102	STX0265	102	T0051	100	T1032	126
ST06	123	ST302	102	STX0268	102	T23	100	T1033	126
ST9	108	ST303	102	STX0269	102	T-3321	126	T1034	126
ST10	108	ST304	102	SV31	102	T-3323	126	T1038	126
ST11	108	ST332	102	SX3711	123	T39	100	T1040	104
ST12	108	ST370	100	SX3826	128	T45	102	T1041	104
ST13	108	ST382	102	SYL101	101	T46	100	T1042	102
ST14	108	ST415	108	SYL102	101	T47	100	T1043	102
ST15	108	ST501	108	SYL103	103	T48	100	T1046	102
ST25A	123	ST502	108	SYL104	103	T50	102	T1047	102
ST25B	123	ST503	128	SYL105	100	T59	100	T1166	126
ST25C	123	ST504	128	SYL106	100	T60	100	T1167	121
ST28A	102	ST903	108	SYL107	102	T61	102	T1168	121
ST28B	102	ST904	108	SYL108	102	T72	102	T1202	100
ST28C	102	ST904A	108	SYL109	121	T74	102	T1203	100

## TRANSISTORS (cont'd)

Type To Be Replaced	Sylvania ECG Replacement	Type To Be Replaced	Sylvania ECG Replacement	Type To Be Replaced	Sylvania ECG Replacement	Type To Be Replaced	Sylvania ECG Replacement	Type To Be Replaced	Sylvania ECG Replacement
T1224	126	T1904	100	T0-014	100	TC2484	108	T1482	128
T1225	126	T1961	100	T0-015	100	TCR13	122	T1483	128
T1232	100	T2015	126	T0-033	102	TCR18	122	T1484	123
T1233	100	T2016	126	T0-038	102	TCR23	122	T1485	108
T1250	126	T2017	126	T0-039	102	TCR28	122	T1492	123
T1251	100	T2019	126	T0-040	102	TCR1005	122	T1493	123
T1275	129	T2020	126	T0-041	102	TCR1505	122	T1494	123
T1276	129	T2021	126	T0-101	100	TCR2005	122	T1495	123
T1289	100	T2022	126	T0-102	100	TF30	102	T1496	123
T1291	100	T2024	126	T0-103	102	TF49	102	T13010	126
T1298	100	T2025	126	T0-104	102	TF65	126	T13011	126
T1299	100	T2026	126	TA-1	105	TF65M	102	T13012	121
T1300	102	T2028	126	TA-2	121	TF65/30	126	T13015	128
T1305	100	T2029	126	TA-3	105	TF66	102	T13016	108
T1306	100	T2030	126	TA-4	102	TF66/30	102	T13027	121
T1310	102	T2038	100	TA-5	126	TF66/60	100	T13028	121
T1312	100	T2039	100	TA-6	123	TF70	101	T13029	121
T1314	126	T2040	100	TA-7	108	TF71	101	T164213	128
T1322	100	T2091	100	TA1575	102	TF72	101	TA1A01	102
T1326	100	T2122	100	TA1575B	100	TF75	102	TA1A03	100
T1327	100	T2159	100	TA1614	121	TF77	102	TA1A04	102
T1328	100	T2172	100	TA1620A	103	TF78	123	TA1A05	100
T1334	100	T2173	100	TA1620B	103	TF78/30	100	TA1A14	108
T1342	100	T2256	100	TA1628	126	TF78/30Z	121	TA1S03	104
T1346	100	T2257	100	TA1650A	126	TF78/60	100	TA1S04	105
T1352	102	T2258	100	TA1655B	100	TF80/30	121	TA1S14	133
T1363	126	T2259	100	TA1658	126	TF80/30Z	102	TA1S18	108
T1364	126	T2260	100	TA1659	126	TG48	121	TA1S22	128
T1366	104	T2261	100	TA1660	126	T-H2SC313	108	TA1S23	128
T1366A	104	T2322	126	TA1662	126	T-H2SC387	108	TA1S24	108
T1367	104	T2323	126	TA1682	121	T-H2SC536	123	TA1S34	132
T1367A	104	T2324	126	TA1682A	121	T-H2SC693	121	TA1S37	129
T1368	104	T2357	106	TA1697	102	T-H2SC715	123	TA1S38	128
T1368A	104	T2364	126	TA1704	100	T1338	126	TA1S44	129
T1369	104	T2379	126	TA1705	121	T1363	100	TA1S45	128
T1369A	104	T2384	126	TA1706	100	T1364	100	TA1S46	128
T1370	104	T2439	100	TA1730	102	T1365	100	TA1S47	128
T1370A	104	T2440	100	TA1731	126	T1366	104	TA1S48	128
T1387	126	T2441	100	TA1755	126	T1366A	104	TA1S49	128
T1388	126	T2446	123	TA1756	126	T1367	104	TA1S51	128
T1389	126	T2788	100	TA1757	126	T1367A	104	TA1S52	128
T1390	126	T2878	100	TA1759	101	T1368	104	TA1S53	129
T1391	126	T2896	126	TA1763	100	T1368A	104	TA1S54	129
T1400	126	T2945	126	TA1763A	100	T1369	104	TA1S55	128
T1401	126	T2946	102	TA1765	121	T1369A	104	TA1S56	128
T1403	126	T3005	100	TA1766	121	T1370	104	TA1S57	128
T1415	123	T3321	102	TA1767	101	T1370A	104	TA1S58	132
T1416	123	T3322	102	TA1771	101	T1387	126	TA1S59	129
T1417	123	T50818	126	TA1772	101	T1388	126	TA1S60	132
T1454	100	T6028	126	TA1773	121	T1389	126	TA1S61	123
T1459	100	T6029	126	TA1778	100	T1390	100	TA1S62	108
T1460	126	T6030	126	TA1782	100	T1391	126	TA1S63	108
T1474	100	T6031	126	TA1783	100	T1393	100	TA1S64	108
T1495	123	T6032	126	TA1794	121	T1395	100	TA1S71	128
T1510	100	T10010	102	TA1796	126	T1396	100	TA1S72	128
T1524BRN	126	T11618	100	TA1797	126	T1397	100	TA1S83	128
T1524BRN/RED	126	T13000	102	TA1798	126	T1398	100	TA1S84	108
T1546	102	T152148	126	TA1828	126	T1399	126	TA1S85	108
T1548	126	T50339A	102	TA1829	126	T1400	126	TA1X90	102
T1573	102	T50631	102	TA1830	126	T1401	126	TA1X91	102
T1574	102	T50944	100	TA1846	126	T1402	126	TA1X92	126
T1577	102	T52147	100	TA1847	126	T1403	126	TA1X316	126
T1583	102	T52147Z	100	TA1860	126	T1407	108	TA1X895	126
T1618	126	T52148Z	100	TA1861	126	T1408	108	TA1X3016	108
T1642B	123	T52149	100	TA1881	121	T1409	108	TA1X3016A	108
T1654	126	T52149Z	100	TA1890	121	T1410	108	TA1X3024	100
T1654BLU	126	T52150	102	TA1891	121	T1411	108	TA1X3032	100
T1657	126	T52150Z	102	TA1928A	127	T1415	123	TA1X401	100
T1690	126	T52151	102	TA2083	127	T1416	123	TA1X402	100
T1691	126	T52151Z	102	TA2188	127	T1417	108	TA1X403	100
T1692	126	T52159	102	TA2301	121	T1418	108	TA1X404	100
T1737	126	T59235A	123	TA2322	126	T1419	108	TA1X405	100
T1738	126	T59247	102	TA2503	108	T1420	128	TA1X401	126
T1740	102	T59249	102	TA2577A	130	T1422	128	TA1X402	126
T1788	126	T59276	123	TA6200	128	T1424	128	TA1X403	126
T1814	126	T59277	123	TAC047	123	T1430	128	TA1X404	126
T1831	126	T0-003	100	TC0914	108	T1431	108	TA1X405	126
T1877	100	T0-004	100	TC0918	108	T1432	128	TA1X406	126
T1902	100	T0-005	100	TC2369A	108	T1480	108	TA1X407	126
T1903	102	T0-012	100	TC2483	108	T1481	123	TA1X408	126

TRANSISTORS (cont'd)

Type To Be Replaced	Sylvania ECG Replacement	Type To Be Replaced	Sylvania ECG Replacement	Type To Be Replaced	Sylvania ECG Replacement	Type To Be Replaced	Sylvania ECG Replacement	Type To Be Replaced	Sylvania ECG Replacement
TIXM10	100	TNJ60283	102	TR06	126	TR722	102	TRC71	102
TIXM11	126	TNJ60362	126	TR-6R26	102	TR760	126	TRC72	102
TIXM13	100	TNJ60363	126	TR-6R35	129	TR761	126	TR-RR38	123
TIXM14	100	TNJ60364	126	TR07	126	TR762	126	TRS1005	124
TIXM15	100	TNJ60365	102	TR-7R35	123	TR763	102	TRS1005LP	124
TIXM16	100	TNJ60604	108	TR08	101	TR1009	130	TRS1205	124
TIXM17	100	TNJ60605	108	TR-8R35	123	TR1490	130	TR1405	124
TIXM18	100	TNJ60606	108	TR09	103	TR1491	130	TRS1405LP	124
TIXM19	100	TNJ60607	108	TR10	101	TR1492	130	TR1605	124
TIXM101	100	TNJ60608	100	TR11	126	TR1493	130	TR1805	124
TIXM103	100	TNJ60610	102	TR12	100	TR1512-80	100	TRS1805LP	124
TIXM104	100	TNJ60611	102	TR13	100	TR1605LP	124	TRS2005	124
TIXM105	100	TNJ60612	102	TR14	126	TR8001	126	TRS2005LP	124
TIXM106	100	TNJ60728	102	TR15	100	TR8002	126	TRS2255	124
TIXM107	100	TNT839	108	TR16	104	TR8003	126	TRS2255LP	124
TIXM108	100	TNT840	108	TR17	126	TR8004	108	TRS2505	124
TIXM201	126	TNT841	108	TR18	126	TR8005	124	TRS2505LP	124
TIXM202	126	TNT843	108	TR19	129	TR8006	126	TR32755	124
TIXM203	126	TO-003	126	TR20	129	TR8007	102	TRS2755LP	124
TIXM204	126	TO-004	126	TR21	128	TR310011	102	TRS3015LP	124
TIXM205	126	TO-005	102	TR22	128	TR310012	102	TRS3016LC	124
TIXM206	126	TO-012	121	TR23	124	TR310015	100	TS4016LC	124
TIXM207	126	TO-014	102	TR25	128	TR310017	102	TS5016LC	124
TIXS09	108	TO-015	121	TR26	130	TR310018	102	TR-TR38	123
TIXS10	108	TO-033	108	TR27	127	TR310019	126		
TIXS12	123	TO-038	108	TR28	129	TR310026	102	TS-1	102
TIXS13	123	TO-039	108	TR30	106	TR310065	126	TS-2	102
TIXS28	108	TO-040	108	TR34	102	TR310068	126	TS-3	102
TIXS29	108	TO-041	102	TR36	108	TR310069	126	TS-13	102
TIXS30	108	TO-101	102	TR38	108	TR310075	102	TS-14	102
TISX31	108	TO-102	102	TR43	102	TR310107	102	TS-15	102
TK23C	126	TO-103	102	TR44	102	TR310123	126	TS-162	102
TK33C	101	TO-104	102	TR45	102	TR310124	126	TS-163	102
TK40	102	TQ1	128	TR51	126	TR310125	102	TS-164	102
TK40C	102	TQ2	108	TR52	126	TR310136	102	TS-165	102
TK41	102	TQ3	108	TR53	100	TR310139	126	TS-166	102
TK41C	126	TQ4	123	TR54	102	TR310147	126	TS-173	121
TK42	102	TQ5	108	TR55	100	TR310150	126	TS-176	104
TK42C	126	TQ6	108	TR56	104	TR310153	102	TS-601	100
TK45C	126	TQ7	108	TR57	105	TR310155	126	TS-602	100
TK49C	103	TQ8	108	TR62	126	TR310156	126	TS-603	102
TMT696	108	TQ9	108	TR71	102	TR310157	126	TS-604	102
TMT697	108	TQ63	129	TR72	102	TR310158	126	TS-609	105
TMT839	108	TQ63A	129	TR81	102	TR310159	102	TS-610	104
TMT840	108	TQ64	129	TR167	101	TR310160	103	TS-612	104
TMT841	108	TQ64A	129	TR182	101	TR310161	100	TS-613	104
TMT842	108	TQ5020	100	TR183	101	TR310164	102	TS-614	104
TMT843	108	TQ5021	126	TR193	101	TR310230	108	TS-615	126
TMT1543	123	TQ5022	126	TR194	101	TR310231	108	TS-616	100
TMT2427	108	TQ5023	102	TR211	101	TR310232	126	TS-617	100
TN53	128	TQ5025	102	TR212	101	TR310235	102	TS-618	100
TN55	128	TQ5026	102	TR213	101	TR310236	103	TS-619	102
TN56	128	TQ5027	102	TR214	101	TRA-4	123	TS-620	126
TN59	128	TQ5028	121	TR216	101	TRA-4A	123	TS-621	126
TN60	128	TQ5031	101	TR262-2	124	TRA-4B	123	TS-627	102
TN61	128	TQ5032	101	TR266-2	124	TRA-7R	121	TS-627A	100
TN62	128	TQ5034	126	TR271TR26	130	TRA-7RM	121	TS-627B	100
TN63	128	TQ5035	126	TR320	102	TRA-8R	121	TS-629	102
TN64	128	TQ5036	121	TR320A	102	TRA-9R	123	TS-630	100
TN237	128	TQ5038	125	TR321	102	TRA-10R	126	TS-672A	100
TNJ60063	126	TQ5039	101	TR321 (HF6H1)	100	TRA-11R	126	TS-672B	100
TNJ60064	126	TQ5049	108	TR321A	102	TRA-12R	126	TS-673A	100
TNJ60065	126	TR01	121	TR323	126	TRA-22	126	TS-673B	102
TNJ60066	108	TR-1R26	126	TR323A	102	TRA-22A	126	TS-739	102
TNJ60067	126	TR-1R35	108	TR331	126	TRA-22B	126	TS-739B	102
TNJ60068	126	TR02	104	TR332	102	TRA-23	126	TS-740	102
TNJ60069	126	TR-2R26	126	TR333	121	TRA-23A	126	TS-765	102
TNJ60070	102	TR-2R35	108	TR334	105	TRA-23B	126	TS-1007	102
TNJ60071	126	TR03	105	TR335	101	TRA-24	126	TS-1266	102
TNJ60073	126	TR-3R26	126	TR336	101	TRA-24A	126	TS-1657	121
TNJ60074	102	TR-3R35	108	TR337	101	TRA-24B	126	TS1727	102
TNJ60075	127	TR-3R38	123	TR338	103	TRA32	102	TS1728	102
TNJ60076	123	TR04	102	TR383 (H6FH-2)	102	TRA33	102	TT204	108
TNJ60077	126	TR-4R26	126	TR482	100	TRA34	123	TT204A	108
TNJ60079	102	TR-4R35	108	TR482A	100	TRA36	123	TT204AB	108
TNJ60080	102	TR-4R38	129	TR508	102	TRC44	100	TT204B	108
TNJ60279	126	TR05	102	TR508A	102	TRC44A	100	TT204C	108
TNJ60280	126	TR-5R26	102	TR650	102	TRC45	102	TT1083	121
TNJ60281	126	TR-5R35	123	TR653	100	TRC50A	100	TT1097	123
TNJ60282	102	TR-5R38	123	TR721	102	TRC45A	102	TV25B126	127

## TRANSISTORS (cont'd)

Type To Be Replaced	Sylvania ECG Replacement	Type To Be Replaced	Sylvania ECG Replacement	Type To Be Replaced	Sylvania ECG Replacement	Type To Be Replaced	Sylvania ECG Replacement	Type To Be Replaced	Sylvania ECG Replacement	Type To Be Replaced	Sylvania ECG Replacement
TV2SB448	127	U2S93	126	VM30234	124	X137	105	ZT781	108	ZT3512	128
TV15	108	U2SB267	102	VM30241	123	X1005	121	ZT782	108	ZT3600	128
TV15A	108	U2T85	103	VM30242	123	XA101	126	ZT783	108	ZT3866	128
TV15B	108	U1177	133	VM30244	102	XA102	126	ZT784	108		
TV16	108	U1178	133	VM30245	124	XA103	100	ZT786	108		
TV17	108	U1180	133	VS-CS1255H	128	XA104	100	ZT787	108		
TV18	108	U1181	133	VS-CS1256HG	129	XA111	126	ZT788	108		
TV19	128	U1285	133	VS2SA71	126	XA112	126	ZT789	108		
TV20	108	U1322	133	VS2SA71B	126	XA121	126	ZT790	128		
TV44	100	U1323	133	VS2SA103	126	XA122	126	ZT793	128		
TV115	108	U1324	133	VS2SA378	126	XA123	126	ZT794	128		
TV116	108	U2848-1	123	VS2SA379	126	XA124	126	ZT110	108		
TV1000	108	U2091858-11	121	VS2SA385	126	XA126	126	ZT111	108		
TV2403	108	UBFY11	108	VS2SB126	127	XA131	126	ZT112	108		
TV2404	108	UC20	133	VS2SB126F	127	XA141	100	ZT113	108		
TV2455	126	UC100	133	VS2SB126V	127	XA142	100	ZT114	108		
TV2402	108	UC105	133	VS2SB128V	127	XA143	100	ZT116	108		
TV24137	126	UC110	133	VS2SB171	102	XB1	102	ZT117	108		
TV24142	127	UC115	133	VS2SB172	102	XB2	102	ZT118	108		
TV24143	103	UC120	133	VS2SB176	102	XB3	102	ZT119	108		
TV24148	108	UC125	133	VS2SB178	102	XB3B	102	ZT152	106		
TV24152	100	UC1100	106	VS2SB178A	102	XB3C	102	ZT153	106		
TV24154	102	UMT3202	124	VS2SB324	123	XB4	103	ZT154	106		
TV24156	102	UTRA-7RM	121	VS2SB448	127	XB5	104	ZT180	106		
TV24158	126	V6/2R	126	VS2SC206	108	XB7	104	ZT181	106		
TV24160	108	V6/2RC	100	VS2SC208	108	XB8	126	ZT182	106		
TV24161	108	V6/2RJ	126	VS2SC288A	108	XB9	100	ZT183	106		
TV24162	127	V6/4R	126	VS2SC324H	123	XB10	100	ZT184	106		
TV24163	127	V6/4RC	100	VS2SC385L	126	XB102	102	ZT187	106		
TV24166	126	V6/4RJ	126	VS2SC538	123	XB103	102	ZT190	128		
TV24172	126	V6/8R	126	VS2SC563	108	XB104	126	ZT191	128		
TV24189	102	V6/8RJ	102	VS2SC645	108	XB112	102	ZT192	128		
TV24194	102	V6/RC	100	VS2SC645A	108	XB113	102	ZT193	128		
TV24229	126	V10/1S	100	VS2SC684	108	XB114	102	ZT202	108		
TV24230	126	V10/1SJ	102	VS2SC762	108	XC101	102	ZT203	108		
TV24239	126	V10/2S	100	VSF2745	100	XC121	102	ZT204	108		
TV24363	129	V10/2SJ	100	WC19862	103	XC141	121	ZT210	128		
TV24372	108	V10/15A	102	WC19862A	102	XC142	121	ZT211	128		
TV24387	108	V10/30A	102	WC19863	102	XC155	104	ZT280	106		
TV24453	128	V10/50A	102	WC19864	102	XC156	104	ZT281	106		
TVS2SA71B	102	V13/11	100	WTV6-PWR	121	XJ13	102	ZT282	106		
TVS2SA103	126	V15/10DP	121	WTV12-PWR	121	XJ71	126	ZT286	129		
TVS2SA171	100	V15/20DP	121	WTV15MG	100	XJ72	126	ZT287	106		
TVS2SA385	126	V15/20R	126	WTV20VHG	102	XJ73	126	ZT402	108		
TVS2SA385A	126	V15/30DP	121	WTV20MG	102	KN12A	104	ZT403	108		
TVS2SB126	121	V30/10DP	121	WTV25-PWR	121	KN12B	104	ZT404	108		
TVS2SB171	102	V30/20DP	121	WTV30VHG	102	KN12C	104	ZT406	128		
TVS2SC208	108	V60/10P	121	WTV30VMG	102	KN12E	104	ZT696	128		
TV135	106	V60/20P	121	WTV40-PWR	121	XT15X3	108	ZT697	128		
TX100-1	123	V60/30P	121	WTV99-PWR	121	YV1	102	ZT706	108		
TX100-2	123	V120	126	WTV129-PWR	105	YV1A	102	ZT706A	108		
TX100-3	124	V120PH	108	WTV199-PWR	121	YV2	102	ZT708	108		
TX100-4	128	V120RH	128	WTV299-PWR	105	ZDT10	108	ZT709	108		
TX100-5	124	V205	106	WTVAT6	102	ZDT11	108	ZT917	108		
TX101-8	124	V220	123	WTVAT6A	100	ZDT20	108	ZT918	108		
TX101-9	128	V221	108	WTVB5	100	ZDT21	108	ZT1479	128		
TX101-11	124	V222	123	WTVB5A	102	ZDT30	108	ZT1481	128		
TX101-12	123	V297	128	WTVBA6	100	ZDT31	108	ZT1487	130		
TX102-1	123	V405	108	WTVBA6A	102	ZJ40	108	ZT1488	130		
TX102-2	123	V410	106	WTVBE6	100	ZJ72	126	ZT1489	130		
TX102-4	124	V435	108	WTVBE6A	102	ZJ73	126	ZT1490	130		
TX103-1	104	VB-11	102	WTV-BMC	100	ZT20	108	ZT1613	128		
TX104-3	102	VD-13	102	WTV-L6	101	ZT21	108	ZT1700	128		
TX106-1	102	VFG2745B	104	WTVSA7	101	ZT22	108	ZT1702	130		
TX107-1	123	VFG-274513	104	WTVSK7	101	ZT23	108	ZT1708	128		
TX107-3	123	VFL-2744K	101	WTVSQ7	101	ZT24	108	ZT1711	128		
TX107-4	123	VFP-2746C	104	WTV3MC	100	ZT40	108	ZT2205	108		
TX107-5	123	VFP-6537C	121	WTV6MC	100	ZT41	108	ZT2206	128		
TX107-6	123	VFQ-2745F	100	WTV12MC	100	ZT42	108	ZT2270	128		
TX107-10	123	VFSSK	126	WTV15VMG	102	ZT43	108	ZT2368	128		
TX107-12	123	VFS-2745	100	WTV20MC	100	ZT44	108	ZT2369	128		
TX107-13	124	VFS-2745J	100	WTV20VHG	102	ZT50	108	ZT2369A	128		
TX108-1	123	VFT-2745H	102	WTV20VMG	102	ZT60	108	ZT2475	128		
TX111-1	124	VFU-2746B	121	WTV30VHG	102	ZT61	108	ZT2476	128		
TX112-1	123	VFW-27450	126	WTV30VLG	102	ZT62	108	ZT2477	128		
TZ8	121	VFY-2745E	100	WTV30VMG	102	ZT63	108	ZT2708	108		
TZ10	102	VL/BRJ	126	X1C1644	102	ZT64	108	ZT2857	108		
U2N84	102	VM30203	121	X16N1485	123	ZT66	108	ZT2938	128		
U2N96	102	VM30209	123	X42	100	ZT68	128	ZT3053	128		
U2N474A	123	VM30233	124	X78	100	ZT80	108	ZT3269A	108		



# DIODES and RECTIFIERS

## replacement guide

Type To Be Replaced	Sylvania ECC Replacement	Type To Be Replaced	Sylvania ECC Replacement	Type To Be Replaced	Sylvania ECC Replacement	Type To Be Replaced	Sylvania ECC Replacement	Type To Be Replaced	Sylvania ECC Replacement	Type To Be Replaced	Sylvania ECC Replacement
0004-003500	116, 117	0402	116, 117	¼M5.6AZ	136	.25T7.5B	138	.75N62	149	1E4	116, 117
003-005400	109	04049B	116, 117	¼M5.6AZ5	136	.25Y9.1	139	.75N82	150	1E5	116, 117
003-006700	109	0410	116, 117	¼M5.6AZ10	136	.25Y9.1B	139	.75N110	151	1E6	116, 117
003-007500	109	0411	116, 117	¼M6.2AZ5	137	.25T10	140	1-016	109, 110	1E7	125
003-009900	109	0412	116, 117	¼M10Z	140	.25T10B	140	1-017	109	1E8	125
003-009100	145	0450	116, 117	¼M10Z10	140	.25T11.5	141	1-20-001-890	116, 117	1E10	125
003-009200	109	0460	116, 117	¼M14	144	.25T11.5B	141	1-530-012-11	116, 117	1E12Z	142
003-009600	109, 110	051-0003	116, 117	¼M14Z5	144	.25T12	142	1-531-105-11	116, 117	1E12Z5	142
003-009700	141	051-0006	116, 117	¼M14Z10	144	.25T12B	142	1-531-105-13	116, 117	1E12Z10	142
003-009900	116	051-0020	116, 117	¼M15Z	145	.25T12.8	143	1-531-106-17	116, 117	1E14Z	144
003-010000	142	051-0024	139	¼M15Z5	145	.25T12.8B	143	1-534-105-13	116, 117	1E14Z5	144
004-002000	116, 117	0552005	116, 117	¼M15Z10	145	.25T14	144	1AC12	142	1E14Z10	144
004-002700	116, 117	0575001	109	¼M27Z	146	.25T14B	144	1AC12A	142	1E15Z	145
004-002800	116, 117	0575005	109	¼M27Z5	146	.25T15	145	1AC12B	142	1E15Z5	145
004-002900	113	0575019	110	¼M27Z10	146	.25T15B	145	1AC15	145	1E15Z10	145
004-003000	116, 117	0575047	116, 117	¼M33Z	147	.25T27	146	1AC15A	145	1E27Z	146
004-003100	119	0727-50	116, 117	¼M33Z5	147	.25T27B	146	1AC15B	145	1E27Z5	146
004-003200	118	08-0040	116, 117	¼M33Z10	147	.25T33	147	1AC27	146	1E27Z10	146
004-003300	116, 117	08-0821	116, 117	¼M6Z2	149	.25T33B	147	1AC27A	146	1E33Z	147
004-003400	116, 117	080050	116, 117	¼M6Z25	149	.25T35	148	1AC27B	146	1E33Z5	147
004-003500	116, 117	085002	109	¼M6Z210	149	.25T55B	148	1AC33	147	1E33Z10	147
004-003600	116, 117	085003	109	¼M8Z2	150	.25T62	149	1AC33A	147	1E62Z	149
004-003700	120	085004	109	¼M8Z25	150	.25T62B	149	1AC33B	147	1E62Z5	149
004-003900	116, 117	085005	110	¼M8Z210	150	.25T82	150	1AC62	149	1E62Z10	149
004-004000	116, 117	085006	109	¼M110Z	151	.25T82B	150	1AC62A	149	1E82Z	150
004-004100	116, 117	085016	109	¼M110Z5	151	.25T110	151	1AC62B	149	1E82Z5	150
004-003100	119	085026	110	¼M110Z10	151	.25T110B	151	1AC82	150	1E82Z10	150
004-03200	118	¼A10	140	¼Z214D	144	.4T5.6	136	1AC82A	150	1E110Z	151
004-03300	116, 117	¼A10A	140	¼Z214D5	144	.4T5.6A	136	1AC82B	150	1E110Z5	151
004-03500	116, 117	¼A10B	140	¼Z214D10	144	.4T5.6B	136	1AC110	151	1E110Z10	151
004-03600	116, 117	¼A14	144	¼Z215D5	145	.4T6.2	137	1AC110A	151	1E702	116, 117
004-03700	116, 117	¼A14A	144	¼Z215D10	145	.4T6.2A	137	1AC110B	151	1E705	116, 117
013-339	116, 117	¼A14B	144	¼Z227D	146	.4T6.8	137	1B05J20	116, 117	1E71	116, 117
015-002	116, 117	¼A15	145	¼Z227D5	146	.4T7.5	138	1B05J40	116, 117	1E72	116, 117
015-006	116, 117	¼A15A	145	¼Z227D10	146	.4T7.5A	138	1B2	116, 117	1E73	116, 117
0100	116, 117	¼A15B	145	¼Z23D	147	.4T7.5B	138	1B8	125	1E74	116, 117
0102	116, 117	¼A27	146	¼Z23D5	147	.4T9.1	139	1B10J20	116, 117	1E75	116, 117
0110	116, 117	¼A27A	146	¼Z23D10	147	.4T9.1A	139	1C2	116, 117	1E76	116, 117
0111	116, 117	¼A27B	146	¼Z26D	149	.4T10	140	1C8	125	1E77	125
0112	116, 117	¼A33	147	¼Z26D5	149	.4T10A	140	1C12Z	142	1E78	125
019-001918	109	¼A33A	147	¼Z26D10	149	.4T11.5	141	1C12ZA	142	1E710	125
019-002718	109	¼A33B	147	¼Z28D	150	.4T11.5A	141	1C15Z	145	1E23.6	134
019-002935	116, 117	¼A62	149	¼Z28D5	150	.4T12	142	1C15ZA	145	1E25.1	135
019-003870-013	116, 117	¼A62A	149	¼Z28D10	150	.4T12A	142	1C27Z	146	1E25.6	136
019-003870-020	116, 117	¼A62B	149	¼Z110D	151	.4T12.8	143	1C27ZA	146	1E29.1	139
019-005043	109	¼A82	150	¼Z110D5	151	.4T12.8A	143	1C33Z	147	1E21Z	142
019-005045	116, 117	¼A82A	150	¼Z110D10	151	.4T14	144	1C33ZA	147	1E21Z5	145
022-3901-001	109	¼A82B	150	¼Z25.1T5	135	.4T14A	144	1C62Z	149	1E227	146
022-3905-001	116, 117	¼A110	151	¼Z25.6T5	136	.4T15	145	1C62ZA	149	1FZ	116, 117
027-000296	116, 117	¼A110A	151	¼Z26.2T5	137	.4T15A	145	1C82Z	150	1F8	125
027-000306	116, 117	¼A110B	151	¼Z212T5	142	.4T27	146	1C82ZA	150	1G02	109
027-000312	116, 117	¼A33.605	134	¼Z215T5	145	.4T27A	146	1C110Z	151	1G8	125
027-300226	113	¼AZ3.6 D10	134	¼Z227T5	146	.4T33	147	1C110ZA	151	1GA	116, 117
03-0018-0	116, 117	¼AZ5.1D	135	¼Z233T5	147	.4T33A	147	1D2	116, 117	1G02	109
03-0021-0	109	¼AZ5.1D5	135	¼Z26T5	149	.4T55	148	1D5.1A	135	1H4Y0	116, 117
0300	116, 117	¼AZ5.1D10	135	¼Z28T5	150	.4T55A	148	1D5.1B	135	1HY50	116, 117
0302	116, 117	¼AZ5.6D	136	¼Z212D5	142	.4T62	149	1D5.6	136	1HY80	125
0307	125	¼AZ5.6D5	136	¼Z212D10	142	.4T62A	149	1D5.6A	136	1HY100	125
0310	116, 117	¼AZ5.6D10	136	.25N14	144	.4T82	150	1D5.6B	136	1JL50	116, 117
0311	116, 117	¼AZ6.2D5	137	.25N15	145	.4T82A	150	1D6.2	137	1JL51	116, 117
0312	116, 117	¼LZ3.6D	102	.25N27	146	.4T110	151	1D6.2A	137	1JL52	116, 117
0314	116, 117	¼LZ3.6D5	102	.25N33	147	.4T110A	151	1D6.2B	137	1JL53	116, 117
0317	125	¼LZ5.6D	136	.25N62	149	.75N5	145	1D6.2SA	137	1JL56	116, 117
0320	116, 117	¼LZ5.6D5	136	.25N82	150	.75N5.1	135	1D6.2SB	137	1JL57	116, 117
0321	116, 117	¼LZ5.6D10	136	.25N110	151	.75N5.6	136	1D8	125	1JL58	125
0322	116, 117	¼LZ6.2D	137	.25T5.6	136	.75N6.2	137	1D10	125	1JL59	125
0324	116, 117	¼LZ6.2D5	137	.25T5.6B	136	.75N7.5	138	1E05	116, 117	1JL63	125
0327	125	¼M3.6AZ5	134	.25T6.2	137	.75N12	142	1E1	116, 117	1JL64	125
0400	116, 117	¼M3.6AZ10	134	.25T6.2B	137	.75N27	146	1E2	116, 117	1M12Z	142
0401	116, 117	¼M5.1AZ5	135	.25T7.5	138	.75N33	147	1E3	116, 117	1M12Z5	142

NOTE — Numbers in ( ) indicates the number of replacement devices required to replace original type.

## DIODES and RECTIFIERS (cont'd)

Type To Be Replaced	Sylvania ECG Replacement	Type To Be Replaced	Sylvania ECG Replacement	Type To Be Replaced	Sylvania ECG Replacement	Type To Be Replaced	Sylvania ECG Replacement	Type To Be Replaced	Sylvania ECG Replacement
1M12Z10	142	1N86	109	1N292	109	1N368	116, 117	1N493B	141
1M14Z	144	1N87	109	1N294	109	1N376	117, 135	1N497	109
1M14Z5	144	1N87A	109	1N295A	109	1N400	117, 116	1N498	109
1M14Z10	144	1N87G	109	1N295X	109	1N400B	117, 116	1N500	109
1M15Z	145	1N87GA	109	1N295	109	1N417	109	1N503	116, 117
1M15Z5	145	1N87S	109	1N296	109	1N418	109	1N504	116, 117
1M15Z10	145	1N87T	109	1N298	111, 112	1N419	109	1N505	116, 117
1M27Z	146	1N90	109	1N298A	109	1N429	137	1N506	116, 117
1M27Z5	146	1N90G	109	1N304	109	1N435	109	1N507	116, 117
1M27Z10	146	1N90GA	109	1N305	109	1N440	117, 116	1N508	116, 117
1M33Z	147	1N91	116, 117	1N306	109	1N440B	117, 116	1N509	125
1M33Z5	147	1N92	116, 117	1N308	109	1N441	117, 116	1N510	125
1M33Z10	147	1N93	116, 117	1N309	109	1N441B	117, 116	1N511	116, 117
1M62Z	149	1N93A	116, 117	1N312	109	1N442	117, 116	1N512	116, 117
1M62Z5	149	1N95	109	1N315	116, 117	1N442B	116, 117	1N513	116, 117
1M62Z10	149	1N96A	109	1N315A	116, 117	1N443	117, 116	1N514	116, 117
1M82Z	150	1N103	109	1N316	117, 116	1N443B	117, 116	1N515	116, 117
1M82Z5	150	1N104	109	1N316A	117, 116	1N444	117, 116	1N516	116, 117
1M82Z10	150	1N105	109	1N317	117, 116	1N444B	117, 116	1N517	125
1M110Z	151	1N107	109	1N317A	117, 116	1N445	116, 117	1N518	125
1M110Z5	151	1N108	109	1N318	117, 116	1N445B	116, 117	1N519	116, 117
1M110Z10	151	1N109	109	1N318A	117, 116	1N447	109	1N520	116, 117
1MJ3J.6	134	1N110	111, 112	1N319	117, 116	1N448	117, 116	1N521	116, 117
1MJ3J.6A	134	1N111	109	1N319A	117, 116	1N449	117, 116	1N522	116, 117
1MJ3J6.2	137	1N112	109	1N320	117, 116	1N451	117, 116	1N523	116, 117
1MJ3J6.2A	137	1N113	109	1N320A	116, 117	1N452	117, 116	1N524	116, 117
1MJ9J.1	139	1N114	109	1N321	116, 117	1N453	117, 116	1N525	125
1MJ9J.1A	139	1N115	109	1N321A	125	1N454	117, 116	1N526	125
1MJ11Z	142	1N116	109	1N322	125	1N455	117, 116	1N527	109
1MJ11Z.A	142	1N116A	109	1N322A	125	1N456	117, 116	1N530	117, 116
1N4A	109	1N117	109	1N323	117, 116	1N456A	117, 116	1N531	117, 116
1N4A.G	109	1N117A	109	1N323A	117, 116	1N457	117, 116	1N532	117, 116
1N34	109	1N118	109	1N324	117, 116	1N457A	117, 116	1N533	117, 116
1N34A	109	1N118A	109	1N324A	117, 116	1N458	117, 116	1N534	117, 116
1N34AS	109	1N119	109	1N325	117, 116	1N458A	117, 116	1N535	117, 116
1N34G	109	1N119A	109	1N325A	117, 116	1N459	117, 116	1N536	117, 116
1N34GA	109	1N120	109	1N326	117, 116	1N459A	117, 116	1N537	117, 116
1N35	109	1N120A	109	1N326A	117, 116	1N460	117, 116	1N538	117, 116
1N36	109	1N124	111, 112	1N327	117, 116	1N460A	117, 116	1N539	117, 116
1N40	109	1N124A	111, 112	1N327A	117, 116	1N461	116, 117	1N540	117, 116
1N41	109	1N125	109	1N328	117, 116	1N461A	116, 117	1N541	110
1N43	109	1N126	109	1N328A	125	1N462	117, 116	1N542	109, 110
1N45	109	1N126A	109	1N329	125	1N462A	117, 116	1N547	116, 117
1N46	109	1N128	109	1N329A	125	1N463	117, 116	1N548	125
1N49	109	1N132	109	1N332	116, 117	1N463A	117, 116	1N550	116, 117
1N51	109	1N133	111, 112	1N333	117, 116	1N464	117, 116	1N551	116, 117
1N50	109	1N134	109	1N335	117, 116	1N464A	117, 116	1N552	116, 117
1N54	109	1N135	109	1N337	117, 116	1N468	135	1N553	116, 117
1N54A	109	1N139	109	1N338	116, 117	1N468A	135	1N554	116, 117
1N54G	109	1N144	109	1N339	116, 117	1N468B	135	1N555	116, 117
1N54GA	109	1N145	109	1N340	117, 116	1N471	134	1N560	125
1N56	109	1N147	111, 112	1N341	116, 117	1N473	135	1N561	125
1N56A	109	1N147A	111, 112	1N342	116, 117	1N473A	135	1N562	125
1N60	109	1N148	109	1N343	116, 117	1N473B	135	1N563	125
1N60A	109	1N151	116, 117	1N344	116, 117	1N476	116, 117	1N568	109
1N60F	109	1N152	116, 117	1N345	116, 117	1N480	109	1N569	109
1N60G	109	1N153	116, 117	1N346	116, 117	1N486B	116, 117	1N571	109
1N60GA	109	1N158	116, 117	1N347	116, 117	1N487	117, 116	1N596	116, 117
1N60P	109	1N172	111, 112	1N348	116, 117	1N482A	117, 116	1N597	125
1N60S	109	1N192	109	1N349	116, 117	1N482B	117, 116	1N598	125
1N64	109	1N195	109	1N350	117, 116	1N483	117, 116	1N599	117, 116
1N64A	109	1N227	143	1N351	117, 116	1N483A	117, 116	1N599A	117, 116
1N64B	109	1N27A	143	1N352	117, 116	1N483B	117, 116	1N600	116, 117
1N64G	109	1N253	116, 117	1N353	117, 116	1N484	117, 116	1N600A	116, 117
1N64GA	109	1N254	116, 117	1N354	117, 116	1N484A	117, 116	1N601	116, 117
1N65	109	1N255	117, 116	1N359	117, 116	1N484B	117, 116	1N601A	116, 117
1N66	109	1N256	117, 116	1N359A	117, 116	1N485	117, 116	1N602	116, 117
1N69	109	1N266	116, 117	1N360	117, 116	1N485A	117, 116	1N602A	116, 117
1N69A	109	1N267	109	1N360A	117, 116	1N485B	117, 116	1N603	116, 117
1N71	109	1N268	109	1N361	117, 116	1N486	117, 116	1N603A	116, 117
1N72	111, 112	1N270	109	1N361A	117, 116	1N486A	117, 116	1N604	116, 117
1N73	109	1N273	109	1N362	117, 116	1N487	116, 117	1N604A	116, 117
1N74	109	1N276	109	1N362A	117, 116	1N487A	116, 117	1N605	116, 117
1N81	109	1N278	109	1N363	117, 116	1N488	117, 116	1N605A	116, 117
1N81A	109	1N279	109	1N363A	117, 116	1N488A	117, 116	1N606	117, 116
1N76G	109	1N281	109	1N364	125	1N492	141	1N606A	117, 116
1N82	111, 112	1N283	109	1N364A	125	1N492A	141	1N607	116, 117
1N82A	111, 112	1N287	109	1N365	125	1N492B	141	1N607A	116, 117
1N82AG	111, 112	1N288	109	1N365A	125	1N493	141	1N608	116, 117
1N84	109	1N289	109	1N367	109	1N493A	141	1N608A	116, 117

DIODES and RECTIFIERS (cont'd)

Type To Be Replaced	Sylvania ECG Replacement	Type To Be Replaced	Sylvania ECG Replacement	Type To Be Replaced	Sylvania ECG Replacement	Type To Be Replaced	Sylvania ECG Replacement	Type To Be Replaced	Sylvania ECG Replacement
1N609	116, 117	1N760	109	1N911	109	1N1217B	116, 117	1N1528	146
1N609A	116, 117	1N761	135	1N941	141	1N1218	116, 117	1N1528A	146
1N610	116, 117	1N761A	135	1N941A	141	1N1220A	116, 117	1N1539	116, 117
1N610A	116, 117	1N761-2	135	1N941B	141	1N1218B	116, 117	1N1540	116, 117
1N611	116, 117	1N765	142	1N942	141	1N1219	116, 117	1N1541	116, 117
1N611A	116, 117	1N765-1	100	1N945	141	1N1219A	116, 117	1N1542	116, 117
1N612	116, 117	1N766	143	1N945A	141	1N1219B	116, 117	1N1543	116, 117
1N612A	116, 117	1N766A	143	1N945B	141	1N12120	116, 117	1N1544	116, 117
1N613	116, 117	1N766-3	144	1N946	141	1N1220A	116, 117	1N1556	116, 117
1N613A	116, 117	1N767-1	145	1N946A	141	1N1220B	116, 117	1N1557	116, 117
1N614	116, 117	1N770	109	1N946B	141	1N1221	117, 116	1N1558	116, 117
1N614A	116, 117	1N772A	109	1N947	117, 116	1N1221A	117, 116	1N1559	116, 117
1N616	109	1N773	109	1N949	109	1N1221B	117, 116	1N1560	116, 117
1N631	109	1N773A	109	1N960	139	1N1222	117, 116	1N1561	116, 117
1N632	109	1N774	109	1N960A	139	1N1222A	117, 116	1N1562	109
1N636	109	1N774A	109	1N960B	139	1N1222B	117, 116	1N1563	116, 117
1N643A	116, 117	1N775	109	1N961	140	1N1223	116, 117	1N1563A	116, 117
1N645	116, 117	1N776	109	1N961A	140	1N1223A	116, 117	1N1564	116, 117
1N645A	116, 117	1N777	109	1N961B	140	1N1223B	116, 117	1N1564A	116, 117
1N645B	116, 117	1N781	109	1N963	142	1N1224	116, 117	1N1565	116, 117
1N646	116, 117	1N788	109	1N963A	142	1N1224A	125	1N1565A	116, 117
1N647	116, 117	1N805	109	1N963B	142	1N1224B	125	1N1566	116, 117
1N648	116, 117	1N819	116, 117	1N965	145	1N1225	125	1N1566A	116, 117
1N649	116, 117	1N821	137	1N965A	145	1N1225A	125	1N1567	116, 117
1N658	116, 117	1N821A	137	1N965B	145	1N1225B	125	1N1567A	116, 117
1N662	116, 117	1N822	137	1N971	146	1N1226	125	1N1568	117, 116
1N663	116, 117	1N823	137	1N971A	146	1N1226A	125	1N1568A	117, 116
1N665	142	1N823A	142	1N971B	146	1N1226B	125	1N1617	116, 117
1N666	145	1N824	137	1N973	147	1N1251	116, 117	1N1618	116, 117
1N669	146	1N825	137	1N973A	147	1N1252	116, 117	1N1619	116, 117
1N673	116, 117	1N827	137	1N973B	147	1N1253	116, 117	1N1620	116, 117
1N675	137	1N827A	137	1N980	149	1N1254	116, 117	1N1644	116, 117
1N676	116, 117	1N829	137	1N980A	149	1N1255	116, 117	1N1645	116, 117
1N677	116, 117	1N829A	137	1N980B	149	1N1255A	116, 117	1N1646	116, 117
1N678	116, 117	1N846	116, 117	1N983	150	1N1256	116, 117	1N1647	116, 117
1N679	116, 117	1N847	116, 117	1N983A	150	1N1257	117, 116	1N1648	116, 117
1N681	116, 117	1N848	116, 117	1N983B	150	1N1258	125	1N1649	116, 117
1N682	116, 117	1N849	116, 117	1N986	151	1N1259	125	1N1650	116, 117
1N683	116, 117	1N850	116, 117	1N986A	151	1N1260	125	1N1651	116, 117
1N684	116, 117	1N851	116, 117	1N986B	151	1N1261	125	1N1652	116, 117
1N685	116, 117	1N852	117, 116	1N994	109	1N1313A	139	1N1653	117, 116
1N686	116, 117	1N853	125	1N995	109	1N1314	140	1N1692	116, 117
1N687	116, 117	1N854	125	1N996	109	1N1314A	140	1N1693	116, 117
1N689	116, 117	1N855	125	1N1008	116, 117	1N1315	142	1N1694	116, 117
1N695	109	1N856	125	1N1028	116, 117	1N1315A	142	1N1695	116, 117
1N695A	109	1N857	116, 117	1N1029	116, 117	1N1337-5	116, 117	1N1696	116, 117
1N706	109	1N858	116, 117	1N1030	116, 117	1N1406	117, 116	1N1697	116, 117
1N701	140	1N859	116, 117	1N1031	116, 117	1N1407	125	1N1701	116, 117
1N708	136	1N860	116, 117	1N1032	116, 117	1N1408	125	1N1702	116, 117
1N708A	136	1N861	116, 117	1N1033	116, 117	1N1415	116, 117	1N1703	116, 117
1N709A	137	1N862	116, 117	1N1035	116, 117	1N1426	142	1N1704	116, 117
1N713	139	1N863	117, 116	1N1036	116, 117	1N1427	145	1N1705	116, 117
1N714	140	1N864	125	1N1037	116, 117	1N1430	146	1N1706	116, 117
1N714A	140	1N865	125	1N1038	116, 117	1N1439	116, 117	1N1707	116, 117
1N716	142	1N866	125	1N1039	116, 117	1N1440	116, 117	1N1708	116, 117
1N716A	142	1N867	125	1N1052	116, 117	1N1441	116, 117	1N1709	116, 117
1N718	145	1N868	116, 117	1N1053	116, 117	1N1442	116, 117	1N1710	116, 117
1N718A	145	1N869	116, 117	1N1054	116, 117	1N1443	125	1N1711	116, 117
1N724	146	1N870	116, 117	1N1055	116, 117	1N1443A	125	1N1712	116, 117
1N724A	146	1N871	116, 117	1N1056	116, 117	1N1485	137	1N1730	125
1N726	147	1N872	116, 117	1N1057	116, 117	1N1486	116, 117	1N1730A	125
1N726A	147	1N873	116, 117	1N1081	116, 117	1N1487	116, 117	1N1735	137
1N733	149	1N874	117, 116	1N1082	116, 117	1N1488	116, 117	1N1763	116, 117
1N733A	149	1N875	125	1N1083	116, 117	1N1489	116, 117	1N1763A	116, 117
1N736	150	1N876	125	1N1084	116, 117	1N1490	116, 117	1N1764	116, 117
1N736A	150	1N877	125	1N1093	109	1N1491	116, 117	1N1764A	116, 117
1N739	151	1N878	125	1N1095	125	1N1492	117, 116	1N1765	136
1N739A	151	1N879	116, 117	1N1096	125	1N1509	136	1N1765A	136
1N747	134	1N880	116, 117	1N1100	116, 117	1N1509A	136	1N1766	137
1N747A	134	1N881	116, 117	1N1101	116, 117	1N1513	142	1N1766A	137
1N752	136	1N882	116, 117	1N1102	116, 117	1N1513A	142	1N1770	139
1N752A	136	1N883	116, 117	1N1103	116, 117	1N1514	145	1N1770A	139
1N753	137	1N884	116, 117	1N1104	116, 117	1N1514A	145	1N1773	142
1N753A	137	1N885	116, 117	1N1105	117, 116	1N1517	146	1N1773A	142
1N757	139	1N886	125	1N1119	116, 117	1N1517A	146	1N1775	145
1N757A	139	1N887	125	1N1122A	116, 117	1N1520A	136	1N1775A	145
1N758	140	1N888	125	1N1169	116, 117	1N1524	142	1N1781	146
1N758A	140	1N889	125	1N1169A	116, 117	1N1524A	142	1N1781A	146
1N759	142	1N909	109	1N1217	116, 117	1N1525	145	1N1783	147
1N759A	142	1N910	109	1N1217A	116, 117	1N1525A	145	1N1783A	147

## DIODES and RECTIFIERS (cont'd)

Type To Be Replaced	Sylvania ECG Replacement	Type To Be Replaced	Sylvania ECG Replacement	Type To Be Replaced	Sylvania ECG Replacement	Type To Be Replaced	Sylvania ECG Replacement	Type To Be Replaced	Sylvania ECG Replacement
1N1793	150	1N2038-1	145	1N2861A	116, 117	1N3238	116, 117	1N3639	116, 117
1N1793A	150	1N2041	135	1N2862	116, 117	1N3239	116, 117	1N3640	116, 117
1N1796	151	1N2041-2	135	1N2862A	116, 117	1N3240	116, 117	1N3641	116, 117
1N1796A	151	1N2046	143	1N2863	116, 117	1N3241	117, 116	1N3642	116, 117
1N1820	136	1N2069	116, 117	1N2863A	116, 117	1N3242	125	1N3656	116, 117
1N1877	142	1N2069A	116, 117	1N2864	117, 116	1N3243	125	1N3657	116, 117
1N1877A	142	1N2070	116, 117	1N2864A	116, 117	1N3246	116, 117	1N3658	116, 117
1N1878	145	1N2070A	116, 117	1N2865	125	1N3247	116, 117	1N3669	116, 117
1N1878A	145	1N2071	116, 117	1N2866	125	1N3248	116, 117	1N3678	139
1N1881	146	1N2071A	116, 117	1N2867	125	1N3249	116, 117	1N3681	142
1N1881A	146	1N2072	116, 117	1N2868	125	1N3250	117, 116	1N3681A	142
1N1882	147	1N2073	116, 117	1N2878	125	1N3251	125	1N3681B	142
1N1882A	147	1N2074	116, 117	1N2879	125	1N3252	125	1N3683	145
1N1887	150	1N2075	116, 117	1N2880	125	1N3253	116, 117	1N3683A	145
1N1887A	150	1N2076	116, 117	1N2881	125	1N3254	116, 117	1N3683B	145
1N1907	116, 117	1N2077	116, 117	1N2882	125	1N3255	117, 116	1N3689	146
1N1908	116, 117	1N2078	116, 117	1N2883	125	1N3256	125	1N3689A	146
1N1909	116, 117	1N2079	116, 117	1N3019	139	1N3257	116, 117	1N3689B	146
1N1910	116, 117	1N2080	116, 117	1N3019A	139	1N3258	116, 117	1N3691	147
1N1911	116, 117	1N2081	116, 117	1N3019B	139	1N3277	117, 116	1N3691A	147
1N1912	116, 117	1N2082	116, 117	1N3022	142	1N3278	116, 117	1N3691B	147
1N1913	116, 117	1N2083	116, 117	1N3022A	142	1N3279	116, 117	1N3698	149
1N1914	125	1N2084	116, 117	1N3022B	142	1N3280	125	1N3698A	149
1N1915	125	1N2085	116, 117	1N3024	145	1N3281	125	1N3698B	149
1N1916	125	1N2086	116, 117	1N3024A	145	1N3282	125	1N3701	150
1N1929	136	1N2088	116, 117	1N3024B	145	1N3287	109	1N3701A	150
1N1929A	136	1N2089	116, 117	1N3030	146	1N3287W	109	1N3701B	150
1N1929B	136	1N2090	116, 117	1N3030A	146	1N3298	116, 117	1N3704	151
1N1932	140	1N2091	116, 117	1N3030B	146	1N3403	142	1N3704A	151
1N1932A	140	1N2092	116, 117	1N3032	147	1N3416	142	1N3704B	151
1N1932B	140	1N2093	116, 117	1N3032A	147	1N3465	109	1N3723	125
1N1934	145	1N2094	116, 117	1N3032B	147	1N3466	109	1N3732	135
1N1934A	145	1N2095	116, 117	1N3039	149	1N3467	109	1N3748	116, 117
1N1934B	145	1N2096	117, 116	1N3039A	149	1N3468	109	1N3749	116, 117
1N1937	146	1N2103	116, 117	1N3039B	149	1N3469	109	1N3750	116, 117
1N1937A	146	1N2104	116, 117	1N3042	150	1N3470	109	1N3751	125
1N1937B	146	1N2105	116, 117	1N3042A	150	1N3484	109	1N3752	125
1N1938	147	1N2106	116, 117	1N3042B	150	1N3486	125	1N3753	109
1N1938A	147	1N2107	116, 117	1N3045	151	1N3493	116, 117	1N3754	116, 117
1N1938B	147	1N2108	116, 117	1N3045A	151	1N3496	137	1N3755	116, 117
1N1943	150	1N2115	116, 117	1N3045B	151	1N3497	137	1N3756	116, 117
1N1943A	150	1N2116	116, 117	1N3062	116, 117	1N3498	137	1N3757	116, 117
1N1943B	150	1N2117	116, 117	1N3063	116, 117	1N3499	137	1N3758	116, 117
1N1960	142	1N2373	116, 117	1N3072	116, 117	1N3500	137	1N3759	116, 117
1N1960A	142	1N2372	116, 125	1N3073	116, 117	1N3507	134	1N3760	125
1N1960B	142	1N2374	125	1N3074	116, 117	1N3511	135	1N3761	125
1N1964	146	1N2482	116, 117	1N3075	116, 117	1N3512	136	1N3773	109
1N1964A	146	1N2483	116, 117	1N3076	116, 117	1N3513	137	1N3822	134
1N1964B	146	1N2484	117, 116	1N3077	116, 117	1N3518	140	1N3826	135
1N1965	147	1N2485	116, 117	1N3078	116, 117	1N3520	142	1N3826A	135
1N1965A	147	1N2486	116, 117	1N3079	116, 117	1N3522	145	1N3827	136
1N1965B	147	1N2487	116, 117	1N3080	116, 117	1N3528	146	1N3827A	136
1N1983	136	1N2488	116, 117	1N3081	117, 116	1N3530	147	1N3866	116, 117
1N1983A	136	1N2489	116, 117	1N3082	116, 117	1N3537	142	1N3867	116, 117
1N1983B	136	1N2501	125	1N3083	116, 117	1N3544	116, 117	1N3868	117, 116
1N1986	140	1N2502	125	1N3084	116, 117	1N3545	116, 117	1N3869	125
1N1986A	140	1N2505	125	1N3106	117, 116	1N3546	116, 117	1N3895	116, 117
1N1986B	140	1N2506	125	1N3107	125	1N3547	116, 117	1N3929	125
1N1988	145	1N2609	116, 117	1N3110	109	1N3548	116, 117	1N3938	116, 117
1N1988A	145	1N2610	116, 117	1N3121	109	1N3549	116, 117	1N3939	116, 117
1N1988B	145	1N2611	116, 117	1N3122	109	1N3563	125	1N3940	116, 117
1N1991	146	1N2612	116, 117	1N3125	109	1N3564	109	1N3952	116, 117
1N1991A	146	1N2613	116, 117	1N3146	109	1N3580	141	1N3957	125
1N1991B	146	1N2614	116, 117	1N3160	116, 117	1N3580A	141	1N3991	109
1N1992	147	1N2615	117, 116	1N3189	116, 117	1N3580B	141	1N4001	116, 117
1N1992A	147	1N2616	125	1N3190	116, 117	1N3581	141	1N4002	116, 117
1N1992B	147	1N2617	125	1N3191	117, 116	1N3581A	141	1N4003	116, 117
1N2013	116, 117	1N2772	125	1N3193	116, 117	1N3581B	141	1N4004	116, 117
1N2014	116, 117	1N2773	125	1N3194	116, 117	1N3582	141	1N4005	116, 117
1N2015	116, 117	1N2774	125	1N3195	117, 116	1N3582A	141	1N4006	125
1N2016	116, 117	1N2775	125	1N3196	125	1N3582B	141	1N4007	125
1N2017	116, 117	1N2850	116, 117	1N3203	116, 117	1N3584	141	1N4011	125
1N2018	116, 117	1N2852	125	1N3204	109	1N3584A	141	1N4043	116, 117
1N2019	116, 117	1N2858	116, 117	1N3227	116, 117	1N3584B	141	1N4044	147
1N2020	116, 117	1N2858A	116, 117	1N3228	116, 117	1N3592	109	1N4088	109
1N2032	135	1N2859	116, 117	1N3229	116, 117	1N3611	116, 117	1N4089	116, 117
1N2036	116, 117	1N2859A	116, 117	1N3230	116, 117	1N3612	116, 117	1N4095	135
1N2037	143	1N2860	116, 117	1N3231	125	1N3613	116, 117	1N4104	140
1N2037-1	142	1N2860A	116, 117	1N3232	125	1N3614	116, 117	1N4108	144
1N2037-3	144	1N2861	116, 117	1N3237	116, 117	1N3615	116, 117	1N4109	145

DIODES and RECTIFIERS (cont'd)

Type To Be Replaced	Sylvania ECC Replacement	Type To Be Replaced	Sylvania ECC Replacement	Type To Be Replaced	Sylvania ECC Replacement	Type To Be Replaced	Sylvania ECC Replacement	Type To Be Replaced	Sylvania ECC Replacement
1N4118	146	1N4369	117, 116	1N4822	116, 117	1N5242A	142	1S80	109
1N4121	147	1N4383	116, 117	1N4842	146	1N5242B	142	1S81	116, 117
1N4129	149	1N4384	116, 117	1N4842A	146	1N5244	144	1S82	109
1N4132	150	1N4385	116, 117	1N4842B	146	1N5244A	144	1S85V	116, 117
1N4161	139	1N4403	139	1N4844	147	1N5244B	144	1S90	116, 117
1N4161A	139	1N4403A	139	1N4844A	147	1N5245	145	1S91	116, 117
1N4161B	139	1N4403B	139	1N4844B	147	1N5245A	145	1S92	116, 117
1N4164	142	1N4406	142	1N4854	150	1N5245B	145	1S93	116, 117
1N4164A	142	1N4406A	142	1N4854A	150	1N5254	146	1S93/SGJ	116, 117
1N4164B	142	1N4406B	142	1N4854B	150	1N5254A	146	1S94	116, 117
1N4166	145	1N4408	145	1N4857	151	1N5254B	146	1S95	117, 116
1N4166A	145	1N4408A	145	1N4857A	151	1N5257	147	1S96	125
1N4166B	145	1N4408B	145	1N4857B	151	1N5257A	147	1S97	125
1N4172	146	1N4414	146	1N4896	143	1N5257B	147	1S98	125
1N4172A	146	1N4414A	146	1N4896A	143	1N5265	149	1S99	125
1N4172B	146	1N4414B	146	1N4897	143	1N5265A	149	1S100	116, 117
1N4174	147	1N4416	147	1N4897A	143	1N5265B	149	1S101	116, 117
1N4174A	147	1N4416A	147	1N4898	143	1N5268	149	1S102	116, 117
1N4174B	147	1N4416B	147	1N4898A	143	1N5268A	150	1S103	116, 117
1N4181	149	1N4423	149	1N4899	143	1N5268B	150	1S104	116, 117
1N4181A	149	1N4423A	149	1N4899A	143	1N5272	151	1S105	116, 117
1N4181B	149	1N4423B	149	1N4900	143	1N5272A	151	1S106	116, 117
1N4184	150	1N4426	150	1N4900A	143	1N5272B	151	1S106A	116, 117
1N4184A	150	1N4426A	150	1N4901	143	1N5277	125	1S107	125
1N4184B	150	1N4426B	150	1N4901A	143	1P541	109	1S108	125
1N4187	151	1N4429	151	1N4902	143	1P542	109	1S109	125
1N4187A	151	1N4429A	151	1N4902A	143	1R9.1	139	1S110	116, 117
1N4187B	151	1N4429B	151	1N4903	143	1R9.1A	139	1S110A	116, 117
1N4240	135	1N4495	137	1N4903A	143	1R9.1B	139	1S111	116, 117
1N4245	116, 117	1N4514	125	1N4904	143	1R12	142	1S112	116, 117
1N4246	116, 117	1N4523	109	1N4904A	143	1R12A	142	1S113	116, 117
1N4247	116, 117	1N4583	141	1N4905	143	1R12B	142	1S113A	116, 117
1N4248	125	1N4583A	141	1N4905A	143	1R15	145	1S114	116, 117
1N4249	125	1N4583B	141	1N4906	143	1R15A	145	1S115	117, 116
1N4250	125	1N4585	125	1N4906A	143	1R15B	145	1S116	117, 116
1N4251	125	1N4586	125	1N4907	143	1R27	146	1S117	125
1N4295	140	1N4625	135	1N4907A	143	1R27A	146	1S119	116, 117
1N4295A	140	1N4626	136	1N4908	143	1R27B	146	1S120	116, 117
1N4299	141	1N4634	142	1N4908A	143	1R33	147	1S121	116, 117
1N4299A	141	1N4636	145	1N4909	143	1R33A	147	1S122	116, 117
1N4299B	141	1N4642	146	1N4909A	143	1R33B	147	1S123	116, 117
1N4300	141	1N4650	134	1N4910	143	1R62	149	1S124	116, 117
1N4300A	141	1N4654	135	1N4910A	143	1R62A	149	1S125	116, 117
1N4300B	141	1N4655	136	1N4911	143	1R62B	149	1S126	116, 117
1N4303	141	1N4656	137	1N4911A	143	1R82	150	1S127	109
1N4303A	141	1N4660	139	1N4912	143	1R82A	150	1S135	141
1N4303B	141	1N4663	142	1N4912A	143	1R82B	150	1S136	137
1N4304	141	1N4665	145	1N4913	143	1R110	151	1S137	145
1N4304A	141	1N4671	146	1N4913A	143	1R110A	151	1S146	116, 117
1N4304B	141	1N4673	147	1N4914	143	1R110B	151	1S147	116, 117
1N4326	139	1N4689	135	1N4914A	143	1R1600	122	1S148	116, 117
1N4326A	139	1N4690	136	1N4915	143	1R1601	122	1S149	116, 117
1N4326B	139	1N4701	144	1N4915A	143	1R1602	122	1S150	116, 117
1N4329	142	1N4702	145	1N5004	116, 117	1R1771	122	1S180	116, 117
1N4329A	142	1N4711	146	1N5005	116, 117	1R1772	122	1S180/5GB	116, 117
1N4329B	142	1N4714	147	1N5006	116, 117	1R1774	122	1S181	116, 117
1N4331	145	1N4729	134	1N5007	116, 117	1S005	117, 116	1S186	109
1N4331A	145	1N4733	135	1N5052	125	1S021	116, 117	1S188	109
1N4331B	145	1N4733A	135	1N5053	125	1S032	116, 117	1S189	109
1N4337	146	1N4734	136	1N5054	125	1S13	109	1S190	135
1N4337A	146	1N4734A	136	1N5055	116, 117	1S15	109	1S195	140
1N4337B	146	1N4735	137	1N5056	116, 117	1S20	109	1S197	142
1N4339	147	1N4735A	137	1N5057	116, 117	1S33	109	1S204	116, 117
1N4339A	147	1N4739	139	1N5058	116, 117	1S34	109	1S205	116, 117
1N4339B	147	1N4739A	139	1N5060	116, 117	1S35	109	1S206	116, 117
1N4346	149	1N4742	142	1N5061	116, 117	1S40	116, 117	1S207	116, 117
1N4346A	149	1N4742A	142	1N5062	125	1S41	116, 117	1S208	116, 117
1N4346B	149	1N4744	145	1N5227	134	1S42	116, 117	1S209	116, 117
1N4349	150	1N4744A	145	1N5227A	134	1S43	116, 117	1S211	125
1N4349A	150	1N4750	146	1N5227B	134	1S44	116, 117	1S239	146
1N4349B	150	1N4750A	146	1N5231	135	1S45	117, 116	1S257	151
1N4352	151	1N4752	147	1N5231A	135	1S46	125	1S309	116, 117
1N4352A	151	1N4752A	147	1N5231B	135	1S47	125	1S310	116, 117
1N4352B	151	1N4759	149	1N5232	136	1S50	109, 110	1S312	116, 117
1N4361	125	1N4759A	149	1N5232A	136	1S58	109	1S313	116, 117
1N4364	116, 117	1N4762	150	1N5232B	136	1S71	116, 117	1S314	116, 117
1N4365	116, 117	1N4762A	150	1N5239	139	1S72	109	1S315	116, 117
1N4366	116, 117	1N4819	116, 117	1N5239A	139	1S73	109	1S318	109
1N4367	116, 117	1N4820	116, 117	1N5239B	139	1S75	109	1S330	125
1N4368	116, 117	1N4821	116, 117	1N5242	142	1S76	109	1S332	116, 117

## DIODES and RECTIFIERS (cont'd)

Type To Be Replaced	Sylvania ECG Replacement	Type To Be Replaced	Sylvania ECG Replacement	Type To Be Replaced	Sylvania ECG Replacement	Type To Be Replaced	Sylvania ECG Replacement	Type To Be Replaced	Sylvania ECG Replacement
1S333	139	1S1624	116, 117	1T55	148	1Z15D5	145	1ZF33T5	147
1S335	140	1S1625	116, 117	1T55B	148	1Z15D10	145	1ZF33T10	147
1S357	109	1S1691	116, 117	1T62	149	1Z15T20	145	1ZF33T20	147
1S358	116, 117	1S1697	116, 117	1T62B	149	1Z27	146	1ZM3.6T5	134
1S358S	116, 117	1S1850	116(2)	1T82	150	1Z27A	146	1ZM3.6T10	134
1S395	116, 117	1S1850R	116(2)	1T82B	150	1Z27B	146	1ZM3.6T20	134
1S396	116, 117	1S2036	134	1T110	151	1Z27C	146	1ZM5.1T5	135
1S397	125	1S2036A	134	1T110B	151	1Z27D	146	1ZM5.1T10	135
1S398	125	1S2051	135	1T231	109	1Z27D5	146	1ZM5.1T20	135
1S399	116, 117	1S2051A	135	1T236	109	1Z27D10	146	1ZM5.6T5	136
1S400	116, 117	1S2051B	135	1T261	109	1Z33	147	1ZM5.6T10	136
1S401	125	1S2056	136	1T501	116, 117	1Z33A	147	1ZM5.6T20	136
1S402	125	1S2056A	136	1T502	116, 117	1Z33B	147	1ZM6.2	137
1S426	109	1S2100	140	1T503	116, 117	1Z33C	147	1ZM6.2T5	137
1S426G	109	1S2100A	140	1T504	116, 117	1Z33D	147	1ZM6.2T10	137
1S441	109	1S2120	142	1T505	116, 117	1Z33D5	147	1ZM6.2T20	137
1S442	109	1S2120A	142	1T506	116, 117	1Z33D10	147	1ZM7.5T5	138
1S446	109	1S2150	145	1T507	125	1Z55	148	1ZM7.5T10	138
1S447	109	1S2150A	145	1T508	125	1Z55A	148	1ZM7.5T20	138
1S451	109	1S2454	109	1T509	125	1Z55B	148	1ZM9.1T5	139
1S456	116, 117	1S7036	134	1T510	125	1Z62	149	1ZM9.1T10	139
1S457	116, 117	1S7036A	134	1T2011	116, 117	1Z62A	149	1ZM9.1T20	139
1S458	116, 117	1S7036B	134	1T2012	116, 117	1Z62B	149	1ZM10T5	140
1S459	116, 117	1S7051A	135	1T2013	116, 117	1Z62C	149	1ZM10T10	140
1S466	109	1S7056	136	1T2014	116, 117	1Z62D	149	1ZM10T20	140
1S474	144	1S7056A	136	1T2015	116, 117	1Z62D5	149	1ZM12T5	142
1S543	111, 112	1S7056B	136	1T2016	116, 117	1Z62D10	149	1ZM12T10	142
1S557	125	1S7100	140	1TA5.6	136	1Z82	150	1ZM12T20	142
1S558	116, 117	1S7100A	140	1TA5.6A	136	1Z82A	150	1ZM15T5	145
1S559	116, 117	1S7100B	140	1TA6.2	137	1Z82B	150	1ZM15T10	145
1S588	116, 117	1S7120	142	1TA6.2A	137	1Z82C	150	1ZM15T20	145
1S685	116, 117	1S7120A	142	1TA7.5	138	1Z82D	150	1ZT12	142
1S686	125	1S7120B	142	1TA7.5A	138	1Z82D5	150	1ZT12B	142
1S687	125	1S7150	145	1TA9.1	139	1Z82D10	150	1ZT15	145
1S689	116, 117	1S7150A	145	1TA9.1A	139	1Z110	151	1ZT15B	145
1S692	136	1S7150B	145	1TA10	140	1Z110A	151	1ZT27	146
1S696	142	1SD7	116, 117	1TA10A	140	1Z110B	151	1ZT27B	146
1S697	145	1SO30	116, 117	1TA11.5	141	1Z110C	151	1ZT33	147
1S700	146	1SO31	116, 117	1TA11.5A	141	1Z110D	151	1ZT33B	147
1S750	112	1SO32	116, 117	1TA12	142	1Z110D5	151	1ZT82	150
1S755	135	1SO34	116, 117	1TA12A	142	1Z110D10	151	1ZT82B	150
1S757	138	1SO36	116, 117	1TA12.8	143	1ZB12	142	2AA113	109
1S760	143	1SO38	125	1TA12.8A	143	1ZB12B	142	2E4	116, 117
1S844	116, 117	1S054	116, 117	1TA14	144	1ZB15	145	2E5	116, 117
1S846	116, 117	1S058	125	1TA14A	144	1ZB15B	145	2E8	125
1S848	125	1T5.6	136	1TA15	145	1ZB27	146	2F4	116, 117
1S850	125	1T5.6B	136	1TA15A	145	1ZB27B	146	2GA	116, 117
1S940	116, 117	1T6.2	137	1TA27	146	1ZB33	147	2G8	116, 117
1S941	116, 117	1T6.2B	137	1TA27A	146	1ZB33B	147	2G13	116, 117
1S942	116, 117	1T7.5	138	1TA33	147	1ZB82	150	2G805	116, 117
1S990	109	1T7.5B	138	1TA33A	147	1ZB82B	150	2HR3J	125
1S1007	109	1T9.1	139	1TA35	148	1ZC3.6	134	2HR3M	125
1S1061	116, 117	1T9.1B	139	1TA55A	148	1ZC5.1	135	2K02	125
1S1062	116, 117	1T10	140	1TA62	149	1ZC5.6	136	2N1600	122
1S1063	116, 117	1T10B	140	1TA62A	149	1ZC6.2	137	2N1601	122
1S1064	116, 117	1T11.5	141	1TA82	150	1ZC9.1	139	2N1602	122
1S1065	125	1T11.5B	141	1TA82A	150	1ZC12	142	2SB-C731	116, 117(4)
1S1066	125	1T12	142	1T110	151	1ZC15	145	2SB-S861	116, 117(4)
1S1096	116, 117	1T12B	142	1TA110A	151	1ZC27	146	2SJ2A	116, 117
1S1211	116, 117	1T12.8	143	1T806	116, 117	1ZF5.1T5	135	2SJ4A	116, 117
1S1212	109	1T12.8B	143	1TS05	116, 117	1ZF5.1T10	135	2SJ8A	125
1S1224	116, 117	1T13	112	1WM6	116, 117	1ZF5.1T20	135	2SJ60A	116, 117
1S1237	116, 117	1T14	144	1Z5.1T10	135	1ZF5.6T5	136	2T501	116, 117
1S1238	116, 117	1T14B	144	1Z6.2T10	137	1ZF5.6T10	136	2T502	116, 117
1S1341	116, 117	1T15	145	1Z9.1	139	1ZF5.6T20	136	2T503	116, 117
1S1342	116, 117	1T15B	145	1Z9.1A	139	1ZF9.1T5	139	2T504	116, 117
1S1343	116, 117	1T22	116, 117	1Z9.1B	139	1ZF9.1T10	139	2T505	116, 117
1S1344	116, 117	1T22A	109	1Z9.1C	139	1ZF9.1T20	139	2T506	116, 117
1S1345	116, 117	1T22B	109	1Z9.1D5	139	1ZF12T5	142	2T507	125
1S1346	116, 117	1T22G	109	1Z9.1D10	139	1ZF12T10	142	2T509	125
1S1347	125	1T23	109	1Z9.1T5	139	1ZF12T20	142	2T510	125
1S1348	125	1T23A	109	1Z12	142	1ZF14T5	144	2W3A	116, 117
1S1472	116, 117	1T23G	109	1Z12A	142	1ZF14T10	144	2W4A	116, 117
1S1514	116, 117	1T23J	109	1Z12B	142	1ZF14T20	144	2W5A	116, 117
1S1515	116, 117	1T23M	109	1Z12C	142	1ZF15T5	145	2W6A	125
1S1516	116, 117	1T26	109	1Z15	145	1ZF15T10	145	2W7A	125
1S1579	113	1T27	146	1Z15A	145	1ZF15T20	145	2W9A	125
1S1621	110	1T27B	146	1Z15B	146	1ZF2T5	146	2XAA111	109
1S1622	116, 117	1T33	147	1Z15C	145	1ZF2T7T10	146	2XAA112	109
1S1623	116, 117	1T33B	147	1Z15D	145	1ZF2T7T20	146	2XAA113	109

**DIODES and RECTIFIERS (cont'd)**

Type To Be Replaced	Sylvania ECG Replacement	Type To Be Replaced	Sylvania ECG Replacement	Type To Be Replaced	Sylvania ECG Replacement	Type To Be Replaced	Sylvania ECG Replacement	Type To Be Replaced	Sylvania ECG Replacement
2X9A116	116, 117	4T504	116, 117	6RW62HY	116, 117	10N1	116, 117	15-108009	113
3A152	116, 117	4T505	116, 117	7D	116, 117	10R1B	116, 117	15-108010	116, 117
3A154	116, 117	4T506	116, 117	7D210	125	10R2B	116, 117	15-108011	116, 117
3A156	116, 117	4T507	125	7D210A	125	10R3B	116, 117	15-108012	118
3A158	125	4T508	125	7MA60	116, 117	10R4B	116, 117	15-108013	119
3A200	116, 117	4T509	125	8-22	116, 117	10R5B	116, 117	15-108014	120
3A252	116, 117	4T510	125	8-25	116, 117	10R6B	116, 117	15J2	116, 117
3A254	116, 117	5A-D	116, 117	8-38	116, 117	10R7B	125	15J2F	116, 117
3A256	116, 117	5A1	116, 117	8-710-222-21	116, 117	10R8B	125	15N1	116, 117
3A258	125	5A2	116, 117	8-719-205-10	116, 117	10R9B	125	15P2	116, 117
3A1510	125	5A3	116, 117	8A01	109	10R10B	125	16-2	116, 117
3A2510	125	5A4	116, 117	8CG15	116, 117	11-085001	109	16C4	116, 117
3AS1	116, 117	5A4D	116, 117	8CG15RE	116, 117	11-085003	116, 117	16J2	116, 117
3AS2	116, 117	5A4D-C	116, 117	8D4	116, 117	11-085004	109	16J2F	116, 117
3BS1	116, 117	5A5	116, 117	8D6	116, 117	11-108002	116, 117(4)	16P2	116, 117
3BS2	116, 117	5A5D	116, 117	8D8	125	11J2	116, 117	16Z4	142
3CS1	116, 117	5A6	116, 117	8D10	125	11J2F	116, 117	16Z6	135
3CS2	116, 117	5A6D-C	116, 117	8GA	125	12-100001	116, 117(4)	16Z6A	135
3DS1	116, 117	5A8	125	8G7	125	12C2P-114	116, 117	17P2	116, 117
3DS2	116, 117	5A8D	125	9LR2	113	12C2P-114	116, 117(4)	17Z6	136
3ES1	116, 117	5A8DC	125	9LR2-1	113	12C2	116, 117	17Z6A	136
3ES2	116, 117	5A10	125	9LR2-2	114	12J2	116, 117	17-10	116, 117
3FS1	116, 117	5A10C	125	9LR2-3	113	12J2F	116, 117	18J2	125
3FS2	116, 117	5A10D	125	9LR2-4	115	12P2	116, 117	18J2F	125
3G8	116, 117	5A10D-C	125	9LR2-S	113	13-0003	116, 117	18P2	116, 117
3G152	116, 117	5B-2-H5W	116, 117	9LR2-S1	113	13-0004	109	18Z6	137
3G154	116, 117	5B3	116, 117	9LR21	113	13-0015	116, 117	18Z6A	137
3G156	116, 117	5B-15H	116, 117	10-7	116, 117	13-10102-1	116, 117	19-040-002	116, 117
3G158	125	5E1	116, 117	10-12	116, 117	13-10321-3	116, 117	19-040-004	116, 117
3G252	116, 117	5E2	116, 117	10-42	116, 117	13-14627-1	116, 117	19-080-002	116, 117
3G254	116, 117	5E4	116, 117	10AG2	116, 117	13-14627-4	116, 117	19AR4-1	114
3G256	116, 117	5GA	116, 117	10AG4	116, 117	13-14879-1	145	19P2	116, 117
3G258	125	5GD	116, 117	10AG6	116, 117	13-14879-2	142	20AS	116, 117
3G1510	125	5GFH	116, 117	10AG8	125	13-14879-3	145	20A1	116, 117
3G2510	125	5GJ/FR1N	116, 117	10AG10	125	13-14879-4	138	20A2	116, 117
3GA	116, 117	5H	116, 117	10AL2	116, 117	13-16104-8	116, 117	20A3	116, 117
3GS1	116, 117	5H4D1	116, 117	10AL6	116, 117	13-16104-9	116, 117	20A4	116, 117
3GS2	116, 117	5H750M	116, 117	10AS	116, 117	13-16105-3	119	20A5	116, 117
3HS1	116, 117	5H-F1	116, 117	10AT2	116, 117	13-16106-1	118	20A6	116, 117
3HS2	116, 117	5MA2	116, 117	10AT4	116, 117	13-16219-7	113	20A8	125
3MS5	116, 117	5MA4	116, 117	10AT6	116, 117	13-16235-8	109	20A10	125
3MS10	116, 117	5MA5	116, 117	10AT8	125	13-16247-3	116, 117	20A90	109
3MS20	116, 117	5MA6	116, 117	10AT10	125	13-17174-1	116, 117	20BS	116, 117
3MS30	116, 117	5MA8	125	10B1	116, 117	13-17174-2	116, 117	20C	116, 117
3MS40	116, 117	5MA10	125	10B2	116, 117	13-17204-1	109	20H	116, 117
3MS50	116, 117	5MF1	116, 117	10B2-B1W	116, 117(4)	13-17557-1	116, 117	20K	116, 117
3RC5A	122	5RC5A	122	10B4	116, 117	13-17569-1	116, 117(4)	20M	116, 117
3RC10A	122	5RC10A	122	10B5	116, 117	13-17569-2	109	20N1	116, 117
3RC20A	122	5RC20A	122	10B6	116, 117	13-17596-4	110	21A001-000	116(3)
3SB-B/32	116, 117(4)	5MS5	116, 117	10B8	125	13-17596-5	109	21A002-000	113
3SB629	116, 117	5MS10	116, 117	10B10	125	13-17825-1	116, 117	21A004-000	119
3T501	116, 117	5MS20	116, 117	10C	116, 117	13-18458-1	116, 117	21A007-000	116, 117
3T502	116, 117	5MS30	116, 117	10C05	116, 117	13-18481-1	116, 117	21A008-000	116, 117
3T503	116, 117	5MS40	116, 117	10C1	116, 117	13-26614-1	116, 117	21A008-001	116, 117
3T504	116, 117	5MS50	116, 117	10C2	116, 117	13-85943-1	113	21A008-002	116, 117
3T505	116, 117	5N1	116, 117	10C3	116, 117	13-85943-2	113	21A008-003	116, 117
3T506	116, 117	6-59010	116, 117	10C4	116, 117	13-85943-3	113	21A009-002	110, 109
3T507	125	6D67800A03	118	10C4D	116, 117	13J2	116, 117	21A020-006	116, 117
3T508	125	6GX1BY1	113	10C5	116, 117	13P1	116, 117	21A037-008	142
3T509	125	6GA175D	116, 117	10C6	116, 117	14J2	116, 117	21A005-000	120
3T510	125	6G4	113	10C8	125	14-501-01	113	21A006-000	120
4AJ4DX52D	116, 117	6G8	116, 117	10C10	125	14-503-02	114	21A008-016	120
4D4	116, 117	6GA1750	116, 117	10D1	116, 117	14-511-01	109	21A009-000	109
4D6	116, 117	6GC1	113	10D2	116, 117	14-514-10	116, 117	21A079-000	116, 117
4D8	116, 117	6GD1	114	10D3	116, 117	14-514-12	114	21A2	113
4GA	116, 117	6GX1	115	10D4	116, 117	14-514-14	114	21A3	118
4JA2FX355	116, 117	6M4	116, 117	10D5	116, 117	14-514-16	110	21A4	119
4JA2X355	116, 117	6RS6PH13BCJ1	119	10D6	116, 117	14-514-17	116, 117	21A6	116, 117
4JAADR700	116, 117	6RS6PH13BKJ1	119	10D7	125	14-515-07	144	21A7	116, 117
4JA4DX250	116, 117	6RS6PH13BMJ1	119	10D8	125	14J2F	116, 117	21-810	116, 117
4JA6MR700	116, 117	6RS7PH30CB1	118	10D10	125	14P2	116, 117	21-810-2	116, 117
4JA10DX3	116, 117	6RS18PH110EB1	118	10DE	116, 117(4)	15-085002	109	21B-14	116, 117
4JA10DX32	116, 117	6RS18PH110BH1	118	10D9	116, 117(4)	15-085002	116, 117	21B-17	116, 117
4JA10E3X	116, 117	6RS18PH110BMB1	118	10G4	125	15-100003	113	23BSC101	116, 117
4JA16MR700M	116, 117	6RS18PH110BN1	118	10GA	125	15-108002	113	21C2	116, 117
4JB2C6	111, 112	6RS36PH13BJJ1	119	10H	116, 117	15-108003	116, 117	24J2	116, 117
4JBC12	111, 112	6RS36PH13BKJ1	119	10J2	116, 117	15-108005	116, 117	24-P8	116, 117
4T501	116, 117	6RS36PH13BLJ1	119	10J2F	116, 117	15-108006	116, 117	24-191	116, 117
4T502	116, 117	6RS51GX12	120	10K	116, 117	15-108007	120	24MW82	109
4T503	116, 117	6RS36PH13BKJ1	119	10M	116, 117	15-108008	116, 117	24MW117	119

## DIODES and RECTIFIERS (cont'd)

Type To Be Replaced	Sylvania ECG Replacement	Type To Be Replaced	Sylvania ECG Replacement	Type To Be Replaced	Sylvania ECG Replacement	Type To Be Replaced	Sylvania ECG Replacement	Type To Be Replaced	Sylvania ECG Replacement	Type To Be Replaced	Sylvania ECG Replacement
24MW192	116, 117(4)	34-8054-5	116, 117	46AR7	116, 117	47-2	112	48K741255		113	
24MW197	116, 117	34-8054-6	116, 117	46AR8	116, 117	48-1005	112	48K741752		114	
24MW199	109	34-8054-7	116, 117	46AR9	116, 117	48-1007	116, 117	48K742698		114	
24MW207	138	34-8054-9	116, 117	46AR10	116, 117	48-8619-3	109	48K746831		116, 117	
24MW208	116, 117(2)	34-8054-10	116, 117	46AR11	116, 117	48-134552	144	48K751724		115	
24MW241	116, 117(2)	34-8054-11	116, 117	46AR12	116, 117	48-134588	109	48K752497		116, 117	
24MW243	109	34-8055-2	116, 117	46AR13	125	48-134653	139	48K754153		114	
24MW244	110	34-8055-3	116, 117	46AR15	125	48-134659	144	48P60022A97		109, 110	
25J2	116, 117	34-8056-1	119	46AR16	125	48-134663	147	48P63075A78		109, 110	
25P1	109	34-8057-3	110	46AR18	125	48-134698	135	48P65112A73		112	
25Z6	142	34-8057-6	109	46AR21	116, 117	48-134699	150	48R66037A05		116, 117	
25Z6A	142	34-8057-8	116, 117	46AR27	116, 117	48-134704	150	48R10001-A01		116, 117	
25J2	116, 117	34-8057-9	116, 117	46AR28	116, 117	48-134728	151	48R10001-A03		116, 117	
27J2	116, 117	34-8057-12	145	46AR29	116, 117	48-134769	116, 117	48R10001-A030-1		116, 117	
27P1	109	34-8057-13	109	46AR35	116, 117	48-134850	141	48R10062A02		116, 117	
27Z6	144	34-8057-16	116, 117	46AR50	125	48-134851	141	48R10062A04		116, 117	
27Z6A	144	34-8058-1	120	46AR52	125	48-134858	147	48R10062A05		116, 117	
27-226	113	34-8058-2	120	46AR59	125	48-134916	113	48R13471		116, 117	
27-C226	113	34-9037-1	113	46AX1	116, 117	48-134917	113	48R134587		109	
28-6-01	116, 117	34M14Z	144	46AX2	116, 117	48-134921	125	48S191A02		116, 117	
28-21-01	116, 117	34M14Z25	144	46AX3	116, 117	48-134955	149	48S191A05		116, 117	
28-22-01	116, 117	34M14Z10	144	46AX4	116, 117	48-134957	139	48S191A06		116, 117	
28-22-04	116, 117	34Z14D5	144	46AX5	116, 117	48-134959	116, 117	48S191A07		116, 117	
28-22-07	116, 117	34Z14D10	144	46AX7	116, 117	48-134971	148	48S10062A01		116, 117	
28-22-10	116, 117	34Z14D	144	46AX8	116, 117	48-134978	125	48S10062A05		116, 117	
28-22-11	116, 117	35-1003	125	46AX9	116, 117	48-134990	116, 117	48S10062A05A		116, 117	
28-22-15	116, 117	35-1004	116, 117	46AX27	116, 117	48-134991	135	48S134736		116, 117	
28-22-19	119	35-1005	116, 117	46AX11	116, 117	48-134993	136	48S134769		116, 117	
28-23-01	118	36Z6	135	46AX12	125	48-137017	144	48S134781		109	
28-25-01	116, 117	36Z6A	135	46AX13	125	48-137029	116, 117	48S134790		116, 117	
28-26-01	120	37Z6	136	46AX14	125	48-137030	141	48S134816		111, 112	
28-25-566-1	116, 117	37Z6A	136	46AX16	116, 117	48-137034	146	48S134851		141	
28J2	116, 117	38Z6	137	46AX17	116, 117	48-137048	144	48S134916		116, 117	
28P1	109	38Z6A	137	46AX19	116, 117	48-66629A02	116, 117	48S134917		113	
28Z6	145	40AS	116, 117	46AX21	116, 117	48-66629A06	116, 117	48S134921		116, 117	
28Z6A	145	40B5	116, 117	46AX30	116, 117	48-741255	113	48S134954		110	
29P1	134	40C	116, 117	46AX34	116, 117	48-741724	115	48S134978		116, 117	
30AS	116, 117	40D6665A03	116, 117	46AX52	116, 117	48-751656	113	48S90158A01		116, 117	
30BS	116, 117	40H	116, 117	46AX54	116, 117	48-01	116, 117	48-110		113	
30B5	116, 117	40J2	116, 117	46AX55	125	48A41508A01	116, 117	49-1042		116, 117	
30C	116, 117	40K	116, 117	46AX56	125	48B62334A01	109, 110	49-3112		116, 117	
30H	116, 117	40JZ	116, 117	46AX59	125	48B62334A02	109	50A		116, 117	
30K	116, 117	40KR	116, 117	46AX70	125	48B66629A03	116, 117	50AS		116, 117	
30M	116, 117	40M	116, 117	46AX82	125	48C134587	109	50B5		116, 117	
30P1	109	40N1	116, 117	46AX85	125	48C191A05	116, 117	50C		116, 117	
30-8057-13	109	40NJ	116, 117	46BD1	116, 117	48C65831A02	115	50D2		116, 117	
32-0000	109	40YP3	116, 117	46BD2	116, 117	48C65837A02	109	50D4		116, 117	
32-0001	109	41-001	120	46BD5	116, 117	48C66037A03	116, 117	50D8		125	
32-0007	110	41-J2	116, 117	46BD8	116, 117	48C66037A04	116, 117	50D10		125	
32-0008	109	42-14027	116, 117	46BD9	116, 117	48C66037A05	116, 117	50E05		116, 117	
32-0039	109, 110	42-17443	116, 117	46BD11	116, 117	48C66037A10	116, 117	50E1		116, 117	
32-0045	116, 117	42-19681	110	46BD12	116, 117	48C66037A12	116, 117	50E2		116, 117	
32-0059	116, 117	42-19865	116, 117	46BD14	116, 117	48C6655A02	120	50E3		116, 117	
32-0060	116, 117	42-19917	143	46BD19	116, 117	48C67926A01	116, 117	50E4		116, 117	
32-0061	116, 117	42-21362	116, 117	46BD25	116, 117	48C742970	112	50E5		116, 117	
32-0062	113	42-21400	110	46BD27	125	48C751656	113	50E6		116, 117	
32-0063	109	42-21408	116, 117	46BD30	125	48D060154A01	110	50E7		125	
32-18537	109	42-21866	116, 117	46BD32	125	48D63590A01	109	50E8		125	
32-18539	110	42A11	116, 117	46BD33	125	48D66037A03	116, 117	50E10		125	
32Z6	134	42A23	116, 117	46BD34	125	48D66037A04	116, 117	50M		117, 118	
32Z6A	134	42B2	116, 117	46BD38	125	48D66037A05	116, 117	50Z12		142	
33-0006	116, 117	42B16	116, 117	46BD39	125	48D66037A08	116, 117	50Z12A		142	
33-0023	116, 117	42J2	116, 117	46BD52	125	48D66653A02	120	50Z12B		142	
33-0025	138	42K25	116, 117	46BD101	125	48D66653APPT01	120	50Z14		144	
33-0026	116, 117(4)	42K32	116, 117	46BR5	116, 117	48D66653APPT03	118	50Z14A		144	
33-0030	116	42X244	116, 117	46BR7	116, 117	48D66653APPT015	118	50Z14B		144	
33-0031	116(3)	42X244B	116, 117	46BR9	116, 117	48D66654A02	116, 117	50Z15		145	
34-8022-6	109	42X245	116, 117	46BR10	116, 117	48D67120A01	116, 117	50Z15A		145	
34-8022-7	109	42X245B	116, 117	46BR11	116, 117	48D67120A02	116, 117	50Z15B		145	
34-8034-7	113	43Z6	140	46BR15	116, 117	48D67120A06	116, 117	50Z15C		145	
34-8037	113	43Z6A	140	46BR17	116, 117	48D67120A07	116, 117	50Z27		146	
34-8037-1	113	45Z2FX365	116, 117	46BR18	125	48D67120A08	119	50Z27A		146	
34-8037-2	113	46-9613	112	46BR21	125	48D90066A01	113	50Z27B		146	
34-8037-3	113	46-8625	112	46BR27	125	48D90066A01	120	50Z27C		146	
34-8048-2	116, 117	46AR1	116, 117	46BR62	125	48D90210A01	109	50Z33		147	
34-8053-2	118	46AR2	116, 117	46BR63	125	48K64169	116, 117	50Z33A		147	
34-8053-3	118	46AR3	116, 117	46BR64	125	48K134587	109	50Z33B		147	
34-8053-4	118	46AR4	116, 117	46BR68	125	48K644681	109	50Z33C		147	
34-8054-1	116, 117	46AR5	116, 117	46BX2	116, 117	48K646954	116, 117	50Z62		149	
34-8054-2	116, 117	46AR6	116, 117	46BX3	116, 117	48K647829	116, 117	50Z62A		149	



DIODES and RECTIFIERS (cont'd)

Type To Be Replaced	Sylvania ECC Replacement	Type To Be Replaced	Sylvania ECC Replacement	Type To Be Replaced	Sylvania ECC Replacement	Type To Be Replaced	Sylvania ECC Replacement	Type To Be Replaced	Sylvania ECC Replacement
50Z62B	149	66X0023-008	116, 117	75Z110A	151	93B5-3-9	113	103-32	113
50Z62C	149	66X0025-000-001	113	75Z110B	151	93B5-4	113	103-34	109
50Z82	150	66X0033-000	116, 117	75Z110C	151	93B5-5	113	103-44	109
50Z82A	150	66X0033-001	116, 117	76-13570-65	112	93B5-6	113	103-47	116, 117
50Z82B	150	66X0035-001	118	78-254566-1	116, 117	93B5-8	113	103-51	109
50Z82C	150	66X0036-001	119	78-254566-4	116, 117	93B5-9	113	103-61	111, 112
50Z110	151	66X0037-001	116, 117	78-271143-1	116, 117	93B12-1	116, 117	103-74	109
50Z110A	151	66X0038-001	116, 117	80AS	125	93B12-2	116, 117	103-79	116, 117
50Z110B	151	66X0039-001	109, 110	80H	125	93B12-3	116, 117	103-82	117, 118
50Z110C	151	66X0040-003	137	83-43-3	116, 117	93B19-1	120	103-90	109
51GX3	120	66X0041-001	116, 117	84-44-3	118	93B24-2	116, 117	103-96	142
51GX14	120	66X0043-001	109	85-5	116, 117	93B24-3	116, 117	103-101	113
53-0051-2	116, 117	66X041-001	116, 117	86-0016-01	116, 117	93B25-3	109	103-102	110
53A002-1	116, 117	66X21	113	86-1-3	116, 117	93B27-1	109	103-105	146
53B001-1	109	66X23	116, 117	86-3-1	114	93B27-2	116, 117	103-114	109
53B003-1	116, 117	66X25	113	86-4-1	116, 117	93B27-3	110	103-131	110
53B004-1	109	66X26	116, 117	86-7-1	116, 117	93B30-1	116, 117	102-142	109
53B010-2	113	66X218	113	86-9-1	113	93B30-3	116, 117	103-145	116, 117
53B010-3	116, 117	67-1000-00	116, 117(2)	86-9-3	116, 117	93B38-1	109	103B86	116, 117
53B010-4	116, 117	67-1003-00	116, 117	86-10-1	109	93B39-6	140	103G3125	116, 117
53B010-5	116, 117	67J2	125	86-15-1	110	93B41-2	109, 110	103G3125A	116, 117
53B010-6	109	67J2A	125	86-18-1	113	93B41-4	116, 117	104B6	116, 117
53B010-7	110	70F40	116, 117	86-20-1	109	93B42-2	116, 117	105-02	109
53B010-8	116, 117	70S40	116, 117	86-21-1	116, 117	93B42-7	116, 117	105-03	109
53B010-9	116, 117	70T40	116, 117	86-22-1	109	93B45-1	116, 117	105B6	116, 117
53B011-1	116(3)	72Z	116, 117	86-22-3	116, 117	93B47-1	116, 117	106B6	116, 117
53B011-2	116(3)	75	116, 117	86-23-3	116, 117	93B48-2	116, 117	107B6	116, 117
53B011-3	118	75D1	116, 117	86-26-1	116, 117	93B51-3	116, 117	108	116, 117
53C001-1	109	75D2	116, 117	86-28-3	116, 117	93B52-1	116, 117	108A4	116, 117
53C002-1	116, 117	75D8	125	86-30-3	116, 117	93B53-1	120	108B6	116, 117
53F001-1	116, 117	75D10	125	86-32-1	116, 117	93B53-2	120	109B6	116, 117
53F002-1	116, 117	75E05	116, 117	86-34-3	116, 117	93B58-1	116, 117	110B6	125
53J001-1	116, 117	75E1	116, 117	86-35-1	139	93B60-3	116, 117	110-629	116, 117
53J002-1	116, 117	75E2	116, 117	86-35-3	116, 117	93C1-20	116, 117	110-635	116, 117
56-5	116, 117	75E3	116, 117	86-37-1	139	93C1-21	116, 117	110-636	116, 117
57-0006	116, 117	75E4	116, 117	86-37-3	120	93C8-1	109	110-672	116, 117
57-23	116, 117	75E5	116, 117	86-40-3	116, 117	93C16-2	116, 117	110-684	116, 117
57-27	116, 117	75E6	116, 117	86-42-3	116, 117	93C19-1	116, 117	111Z4	141
57-36	118	75E7	125	86-44-3	118	93C24-2	116, 117	112-500-0-501	116, 117
57-42	116, 117	75E8	125	86-45-1	109	93C25-2	110	112-601-0-102	116, 117
60AS	116, 117	75E10	125	86-45-3	119	93C26-7	113	113A7739	116, 117
60C	116, 117	75R1B	116, 117	86-46-3	116, 117	93C26-9	113	115Z4	145
60D	117, 116	75R2B	116, 117	86-47-3	116, 117	93C27-1	109	120-001-300	116, 117
60DE10	125	75R3B	116, 117	86-48-1	110	93C27-2	109	120-001-301	116, 117
60H	117, 116	75R4B	116, 117	86-49-3	116, 117	93C30-1	116, 117	124J490	116, 117
60J2	116, 117	75R5B	116, 117	86-50-3	116, 117	93C30-3	116, 117	126-4	116, 117
60M	117, 116	75R6B	116, 117	86-51-3	116, 117	93C39-13	142	142-006	116, 117
61-7728	116, 117	75R7B	125	86-52-1	116, 117	93C40	119	145A9254	116, 117
61-8968	119	75R8B	125	86-54-3	116, 117	93C42-2	116, 117	145A9786	116, 117
61-8969	118	75R9B	125	86-55-3	120	93C52-1	116, 117	150	116, 117
61J2	116, 117	75R10B	125	86-56-3	120	93C64-1	109, 110	154A3992	116, 117
62J2	116, 117	75Z12	142	86-57-3	116, 117	93K2-1	113	162J2	116, 117
63J2	116, 117	75Z12A	142	86-58-3	116, 117	94-1066-1	116, 117	163J2	116, 117
63-50128-2	112	75Z12B	142	86-59-3	116, 117	96-5022-01	116, 117	164J2	116, 117
64J2	116, 117	75Z12C	142	86-62-3	116, 117	96-5022-1	116, 117	165	113
65	116, 117	75Z14	144	86-63-3	116, 117	96-5023-01	116, 117	165J2	116, 117
65A	116, 117	75Z14A	144	86-68-3	116, 117(4)	98-302	116, 117	166	115
65J2	116, 117	75Z14B	144	86-68-3A	116, 117(4)	100A	116, 117	166J2	116, 117
65P117	116, 117	75Z14C	144	86-5009-3	116, 117	100D10	125	167J2	125
65P124	116, 117	75Z15	145	86-5024-3	116, 117	100R1B	116, 117	173A3981	116, 117
65P124-1	116, 117	75Z15A	145	87-56-3	120	100R2B	116, 117	173A3981-1	116, 117
65P124-2	116, 117	75Z15B	145	88-125	116, 117	100R3B	116, 117	173A4393	116, 117
65P153	116, 117	75Z15C	145	88-831	116, 117	100R4B	116, 117	186-654	116, 117
65P155	116, 117	75Z27	146	88-832	116, 117	100R5B	116, 117	200	116, 117
65P206	116, 117	75Z27A	146	88-833	116, 117	100R6B	116, 117	211Z4	141
65P284	116, 117	75Z27B	146	91A06	116, 117	100R7B	125	212-18	116, 117
65P297	116, 117	75Z27C	146	92B12-2	116, 117	100R8B	125	212-23	116, 117
66-6030-00	116, 117	75Z33	147	93A5-2	113	100R9B	125	212-25	116, 117
66-6031-00	116, 117	75Z33A	147	93A12-1	116, 117	100R10B	125	212-27	116, 117
66J2	116, 117	75Z33B	147	93A38-1	109	101B6	116, 117	212-33	116, 117
66X0020-000	109	75Z33C	147	93A41-2	109	102-02	109	212-35	116, 117
66X0020-001	109	75Z62	149	93A59-1	112	102-207	109	212-36	116, 117
66X0023-1	116, 117	75Z62A	149	93B1-6	116, 117	102B6	116, 117	212-37	116, 117
66X0023-001	116, 117	75Z62B	149	93B1-18	116, 117	102D	116, 117	212-39	116, 117
66X0023-002	116, 117	75Z62C	149	93B1-20	116, 117	103-19	109	212-40	116, 117
66X0023-003	116, 117	75Z82	150	93B1-21	116, 117	103-20	113	212-41	116, 117
66X0023-004	116, 117	75Z82A	150	93B5-1	113	103-22	109	212-42	116, 117
66X0023-005	116, 117	75Z82B	150	93B5-3	113	103-23	109, 110	212-46	120
66X0023-006	116, 117	75Z82C	150	93B5-3-6	113	103-29	116, 117	212-47	116, 117
66X0023-007	116, 117	75Z110	151	93B5-3-8	113	103-31	109	212-48	118

## DIODES and RECTIFIERS (cont'd)

Type To Be Replaced	Sylvania ECG Replacement	Type To Be Replaced	Sylvania ECG Replacement	Type To Be Replaced	Sylvania ECG Replacement	Type To Be Replaced	Sylvania ECG Replacement	Type To Be Replaced	Sylvania ECG Replacement
212-49	116, 117	324-0135	116, 117	400A	109	690V068H32	109	2093B41-11	109
212-50	116, 117	324-0147	116, 117	400D	109	690V069H39	116, 117	2093B41-12	116, 117
212-51	116, 117	324-0160	109	403-1	109	690V073H60	109	2093B41-18	116, 117
212-58	116, 117	324-0162	116, 117	412Z4	141	690V080H50	125	2093B41-20	116, 117
212-61	116, 117	325-0025-327	109	429-0910-53	110	690V080H51	116, 117	2093B41-21	116, 117
212-62	116, 117	325-0031-335	109	429-0910-54	109	690V080H54	116, 117(74)	2102	116, 117
212-63	120	325-0042-311	116, 117	429-0925-56	109	690V080H91	116, 117	2102-010	109
212-64	116, 117	325-0054-312	116, 117(74)	454-A2534-1	116, 117	690V082H40	116(4)	2102-014	116, 117
212-65	116, 117	325-0076-315	116, 117	454-A2534-10	116, 117	690V083H89	109	2102-017	116, 117
212-68	119	325-0135-B	116, 117	471-010	116, 117	690V086H91	116, 117	2102-025	109
212-70	116, 117	325-0141-23	116, 117	474-004	116, 117	690V086H92	116, 117	2102-028	109
212-71	116, 117	325-1376-60	109	474-025	116, 117	702-810	113	2102-074	116, 117
212-72	116, 117	325-1441-10	116, 117	517-0021	116, 117	710	116, 117	2152	116, 117
212-76	116, 117(74)	325-1441-11	116, 117	517-0025	116, 117	742	109	2206	116, 117
212-77	116, 117	325-1446-29	116, 117	517-0031	116, 117	756	116, 117	2252	116, 117
212-79	116, 117	354-9101-002	116, 117	517-0033	116, 117	750C838-11	116, 117	2302	116, 117
212-85	118	354-9102-001	116, 117	523-0001-002	116, 117(74)	792-238	116, 117(74)	2400-23	116, 117
215-51	116, 117	359A	116, 117	523-0006-002	109	792-292	109	2400-27	116, 117
215-58	116, 117	359B	116, 117	523-1000-067	109	800-002-00	109	2402	116, 117
215Z4	145	359C	116, 117	573-1000-295	109	800-003-00	109	2762	116, 117
227-200001	113	359D	116, 117	523-1000-881	116, 117	800-004-00	142	2766	116, 117
229-1054-5	116	359F	116, 117	523-1002-326	109	800-006-00	116, 117	2777	116, 117
229-1054-82	117, 116	359H	116, 117	523-2001-100	143	800-013-00	116, 117	2779	116, 117
264P00501	113	359K	116, 117	523-2003-100	140	800-014-00	116, 117	2784	116, 117
264P00601	116, 117	359M	116, 117	523-2004-100	140	800-021-00	109	2786	116, 117
264P01305	109	359P	125	530-111-1	116, 117	800-024-00	116, 117	2794	116, 117
291-04	116, 117	359S	125	532-341	116, 117	805-1060	109	2795A	139
295V006H03	116, 117	359V	125	532-341A	116, 117	808-206	116, 117	2796	110
295V006H05	116, 117	359Z	125	536J2F	116, 117	808-312	109	2802	125
295V006H07	116, 117	366B	116, 117	537J2F	116, 117	822-1	116, 117	3001A	116, 117
295V014H04	116, 117	369-2	116, 117	538J2F	116, 117	822-2	116, 117	3700-153	116, 117
295V017H01	116, 117	369-3	116, 117	539J2F	116, 117	822-3	116, 117	4552	144
295V020G01	116, 117	380H61	116, 117	540J2F	116, 117	822-4	116, 117	4653	139
295V020H01	116, 117	380K52	116, 117	547J2F	125	822-5	116, 117	4663	147
295V023H01	116, 117	380M63	116, 117	600	116, 117	880-207-000	116, 117	4699	150
295V027C01	116, 117	384A	116, 117	601	116, 117	936-10	116, 117	4704	150
295V028C02	116, 117	384B	116, 117	604B	116, 117	964-17443	116, 117	4728	151
295V028C03	116, 117	384C	116, 117	608	116, 117	964-19865	116, 117	4850	141
295V028C04	125	384D	116, 117	610	116, 117	1005	136	4851	141
295V029C01	116, 117	384F	116, 117	610C	116, 117	1010	140	4858	147
295V031B	119	384H	116, 117	612	116, 117	1014	116, 117	5122	142
295V031C02	120	384K	125	614	116, 117	1015	145	5124	145
295V034C01	119	384M	125	618	116, 117	1020	116, 117	5130	146
206V002H07	109	384P	125	620	116, 117	1024	116, 117	5132	147
296V002H08	116, 117	384S	125	622	116, 117	1027	146	5139	149
296V004H01	113	384V	125	624	116, 117	1030	116, 117	5142	150
296V006H02	109	384Z	125	624-0005	113	1033-8	116, 117	5145	151
296V006H03	116, 117	385A	116, 117	624-0006	113	1034	116, 117	5222	142
296V020B01	116, 117	385B	116, 117	624-0007	113	1040	116, 117	5224	145
296V024B01	109	385C	116, 117	624-0009	116, 117	1044	116, 117	5230	146
301-1	120	385D	116, 117	624-0010	116, 117	1050	116, 117	5239	149
304B	116, 117	385F	116, 117	629A02	116, 117	1060	116, 117	5242	151
307A	116, 117	385H	116, 117	630-002	109	1070	125	5245	151
307B	116, 117	385K	116, 117	630-052	116, 117	1080	125	5416	116, 117
307C	116, 117	385KW	116, 117	630-077	140	1084	125	6629A05	116, 117
307D	116, 117	385M	116, 117	630-079	109	1090	125	7209A	120
307F	116, 117	385P	125	630-086	148	1095J2F	116, 117	7213	116, 117
307H	116, 117	385S	125	650	109	1096J2F	116, 117	7510	125
307K	116, 117	385Z	125	650-110	116	1104	125	7702-1A	125
307M	116, 117	386-IAY	116, 117	651	135	1105	136	7704-1	125
310	116, 117	386-1CY	116, 117	651C4	135	1110	140	7706-1	125
310-4	116, 117	386-1FY	116, 117	651C5	135	1115	145	7708-1	125
311Z4	141	386AK	116, 117	651C6	135	1127	146	7710-1	125
320A	116, 117	386AW	116, 117	652C1	136	1133	147	7711-1	125
320B	116, 117	386AX	116, 117	652C7	137	1138	116, 117	7712-1	125
320C	116, 117	386AY	116, 117	655C9	140	1263A	116, 117	7713-1	125
320D	116, 117	386BW	116, 117	684-652423-1	116, 117	1550	109	9348-3	116, 117
320F	116, 117	386BY	116, 117	690V031H33	116, 117	1616C	113	9650-001	116, 117
320H	116, 117	386CW	116, 117	690V034H32	109	1616C	114	10031	113
320K	116, 117	386CX	116, 117	690V037H92	120	1617C	115	10100	125
320M	116, 117	386CY	116, 117	690V038H22	116, 117	1778-17	109	11746	116, 117
320P	125	386DW	116, 117	690V038H23	113	1884A	139	12602	116, 117
320S	113	386FW	116, 117	690V039H17	119	2052	116, 117	12720	116, 117
324-0011	113	386FX	116, 117	690V039H18	118	2060-024	116, 117	12736	116, 117
324-0015	120	386FY	116, 117	690V039H52	116, 117	2093B4-6	116, 117	12746	116, 117
324-0107	110	386K	116, 117	690V039H54	120	2093B38-14	116, 117	12768	116, 117
324-0117	116, 117	386KX	116, 117	690V041H08	116, 117	2093B41-6	116, 117	12786	116, 117
324-0119	116, 117	386KY	116, 117	690V052H50	109	2093B41-8	116, 117	12788	116, 117
324-0120	116, 117	386MW	116, 117	690V052H68	109	2093B41-9	116, 117	12803	116, 117
324-0093	109	386MY	116, 117	690V066H48	109	2093B41-10	116, 117	12808	109

DIODES and RECTIFIERS (cont'd)

Type To Be Replaced	Sylvania ECC Replacement	Type To Be Replaced	Sylvania ECC Replacement	Type To Be Replaced	Sylvania ECC Replacement	Type To Be Replaced	Sylvania ECC Replacement	Type To Be Replaced	Sylvania ECC Replacement
12837	116, 117	72128	110	118825	116, 117	530065-1	109	575050	116, 117
12850	109	72129	109	118873	116, 117	530065-2	109	575051	116, 117
13782	116, 117	72130	117, 116	119594	140	530065-3	109	575995	120
14027	116, 117	72130-1	117, 116	119596	109, 110	530071-1	116, 117	576063	109
17002	116, 117	72135	138	119597	116	530071-2	116, 117	580029	116, 117
17443	116, 117	72137	116, 117	119662	112	530071-3	116, 117	606113	116, 117
25202-002	109	72145	116(5)	119919	109	530072-6	109	607101	113
34174	116, 117	72145A	116(5)	120231	116, 117(4)	530073-7	109	607113	116, 117
34394	116, 117	83008	116, 117	120544	116, 117	530072-8	116, 117	608030	116, 117
35287	116, 117	91001	116, 117	121468	116, 117	530072-9	116, 117	608101	116, 117
35287A	116, 117	93005	116, 117	122129	116, 117	530072-11	116, 117	608113	116, 117
35289	116, 117	93006	116, 117	122166	109	530072-14	116, 117	609030	116, 117
35306	116, 117	93007	116, 117	122520	109	530072-15	109	609113	116, 117
35500	116, 117	93011	116, 117	123702	116, 117(4)	530073-12	145	610030	109, 110
36201	116, 117	93012	116, 117	123804	116, 117	530073-13	143	610112	116, 117
36508	109	93022	116, 117	124098	116, 117	530073-17	145	612112	116, 117
36535	116, 117	93022A	116, 117	124812	116, 117	530073-18	146	613020	116, 117
36537	116, 117	93023	116, 117	125105	116, 117	530082-1	116, 117	613130	116, 117
36539	142	93030	140	125261	112	530082-2	116, 117	614010	116, 117
36549	116, 117	95002	109	125258	116	530082-3	116, 117	614020	109, 110
36554	116, 117	95014	109	125471	116, 117	530082-1003	116, 117	616010	113
36555	116, 117	95015	116, 117	125529	116	530082-1	116, 117	632977	114
36564	116, 117	98613-43	109	125748	116, 117(2)	530082-2	120	661010	116, 117(2)
37126-1	116, 117	100471	113	125844	116	530088-1	125	699739	116, 117(2)
37680	116, 117	100520	116, 117	126131	116, 117	530088-2	125	700021-00	118
37987	116, 117	100624	116, 117	126177	109	530092-1	109	700043-00	116, 117
38174	116, 117	101403	116, 117	126320	116, 117	530092-1001	109	700055-00	113
40024	116, 117	103318	116, 117	126321	116, 117	530092-2	109	700063-00	116, 117
40265	116, 117	103872	113	126413	116, 117(4)	530093-1	113	700190-00	109, 110
40383	116, 117	104081	116, 117	126849	116(4)	530093-2	114	700647	116, 117
44465-3	116, 117	104152	109	126852	145	530093-3	114	700663	116, 117
44465-4	116, 117	104213	116, 117	126856	116, 117	530094-1	116, 117	700664	116, 117
44465-5	116, 117	105064	120	126861	118	530095-1	116, 117	701662-00	116, 117
44465-6	116, 117	106379	116, 117	126862	119	530096	118	742008	116, 117
46140-2	116, 117	107268	115	127176	116, 117	530096-1	119	742009	116, 117
47126	116, 117	107628	115	127396	116, 117	530096-2	120	744002	113
47126-1	116, 117	109328	113	161001	109, 110	530096-3	119	744006	113
47126-1A	116, 117	109474	113	161006	109	530097-2	120	752309	116, 117
47126-2	116, 117	110388	116, 117	161015	109	530097-3	119	815138	116, 117
47126-3	116, 117	110496	116, 117	161016	109	530098-1	116, 117	815142	116, 117
47126-3A	116, 117	110610	109	161021	116, 117	530099-1	116, 117	817062	114
47126-4	116, 117	110629	116, 117	161027	112	530099-3	116, 117	817068	116, 117
47126-4A	116, 117	110636	116, 117	161029	116, 117	530099-4	116, 117	817074	113
47126-6	116, 117	110873	116, 117	161030	116, 117	53105-1	109	817077	109
47126-7	116, 117	111086	116, 117	161031	116, 117	53106-1	116, 117	817104	116, 117
48287	109	111516	116, 117	161032	116, 117	53109-1	116, 117	817109	116, 117
50501-01	109	111642	116, 117	161033	116, 117	531011-1	116, 117	817111	116, 117
50745-01	116, 117	111776	116, 117	161034	112	531013-1	116, 117	817112	116, 117
50745-02	116, 117(4)	111820	116, 117	161037	117	530113-2	125	817114	116, 117
50745-06	116, 117	112017	116, 117	161038	109	530116-1	110	817117	116, 117
50745-07	116, 117	112018	116, 117	162002-039	109	530118-2	142	817121	116, 117
50745-08	116, 117	112329	116	170733-1	110	530120-1	116, 117	817122	116, 117
53092-1	109	112330	109	190404	140	530122-1	116(3)	817123	118
53099-1	116, 117	112524	109, 110	190716	109	530123-1	109, 110	817124	119
53099-3	116, 117	112528	109	199919	116, 117	530123-3	125	817125	109
66682-42	116, 117	112529	109	199985	116(3)	530123-4	116, 117	817126	113
68177	116, 117	112530	139	202315	109	530123-5	116, 117	817127	113
68177A	116, 117	112531	116	202463	116, 117	530123-7	116, 117	817128	116, 117
68504-76	109, 110	112826	116, 117	223216	116, 117	530124-1	116, 117	817130	116, 117
68504-77	109	113039	116, 117	226182	116, 117	530124-3	116, 117(4)	817133	116, 117
68504-78	116, 117	113321	116, 117	282601	120	530126-1	116, 117	817134	116, 117
69213-78	116, 117	113391	119	330003	116, 117	530127-1	109	817135	116, 117
72036	115	113392	119	330018	116, 117	530127-4	117, 116	817138	116, 117
72041	116, 117	113397	118	330019	116, 117	530127-5	113	817140	116, 117
72053	113	113398	116, 117	348048-2	116, 117	530127-6	117, 116	817141	116, 117
72058	116, 117	113998	116, 117	464010	116, 117	530132-1	118	817143	116, 117
72058A	116, 117	114013	116, 117	464070	116, 117	551026	116, 117	817148	116, 117
72060	109	115039	116, 117	500001	109, 110	552005	125	817149	120
72060	109	115101	109	530045-1	114	552006	116, 117	817155	142
72097	116, 117	115123	138	530045-2	114	552007	116, 117	817156	116, 117
72101	116, 117	115559A	116, 117	530045-3	114	552010	116, 117	817157	117, 116
72103	116, 117	115599	116, 117	530045-4	114	575001	109	817158	109
72109	116, 117	115867	116, 117	530057-1	116, 117	575002	109	817159	109
72110	118	116052	116, 117	530063-1	109, 110	575005	109	817160	110
72111	119	116314	111, 112	530063-4	109	575019	109	817161	116, 117
72113	116, 117	117145	116, 117	530063-6	116, 117	575028	116, 117	817166	116, 117
72113A	116, 117	117145A	116, 117	530063-7	116, 117	817962	116, 117	817962	114
72119	116, 117	117659	109	530063-11	116, 117	575047	116, 117	927571-2	118
72123	116, 117	117730	109	530063-12	116, 117	575048	116, 117	927571-3	119
72123A	116, 117	118244	116, 117	530063-14	110	575049	116, 117	927571-4	116, 117

## DIODES and RECTIFIERS (cont'd)

Type To Be Replaced	Sylvania ECG Replacement	Type To Be Replaced	Sylvania ECG Replacement	Type To Be Replaced	Sylvania ECG Replacement	Type To Be Replaced	Sylvania ECG Replacement	Type To Be Replaced	Sylvania ECG Replacement
973936-8	116, 117	7570014-02	116, 117	A2B4	116, 117	A4C1	116, 117	A13M2	125
973962-1	116, 117	7570016-02	109	A2B5	116, 117	A4C5	116, 117	A14C	116, 117
980143	116, 117	7570215-21	116, 117	A2B9	116, 117	A4C9	116, 117	A14E	116, 117
980164	116, 117	7570215-24	116, 117	A2D1	116, 117	A4D1	116, 117	A23	116, 117
980514	109	7570215-34	116, 117	A2C4	116, 117	A4D5	116, 117	A25-1007	109
980964	116, 117	8051060	109	A2C5	116, 117	A4D9	116, 117	A25-1008	116, 117
981150	109	8521587-1	116, 117	A2C9	116, 117	A4E1	116, 117	A30	109
981153	109	9246053	116, 117	A2D1	116, 117	A4E5	116, 117	A50	116, 117
981207	109	9246055	116, 117	A2D4	116, 117	A4E9	116, 117	A86-3-1	115
981522	109	9248015	116, 117	A2D5	116, 117	A4F1	116, 117	A86-4-1	114
981676	109	9248055	116, 117	A2D9	116, 117	A4F5	116, 117	A86-9-1	113
981739	116, 117	9248058	116, 117	A2E1	116, 117	A4F9	116, 117	A95-5280	113
982214	116, 117	13033801	116, 117	A2E4	116, 117	A4G1	116, 117	A95-5281	116, 117
982253	116, 117	13038900	116, 117	A2E5	116, 117	A4G5	116, 117	A95-5289	116, 117
982254	139	27123050	116, 117	A2E9	116, 117	A4G9	116, 117	A95-5296	119
982270	109, 110	27123070	116, 117	A2F1	116, 117	A4H1	125	A95-5296	118
982271	109, 110	27123100	116, 117	A2F4	116, 117	A4H5	125	A95-5297	113
982337	116, 117	27123100A	116, 117	A2F5	116, 117	A4H9	125	A100	116, 117
982526	116, 117	27123120	116, 117	A2F9	116, 117	A4K1	125	A101-A	116, 117
983413	116, 117	43540012	116, 117	A2G1	116, 117	A4K5	125	A108	116, 117
984182	116, 117	A04049B	116, 117	A2G4	116, 117	A4K9	125	A123-7	116, 117
984183	116, 117	A04091A	116, 117	A2G5	116, 117	A4M1	125	A132	116, 117
984189	116, 117	A04092	116, 117	A2G9	116, 117	A4M5	125	A200	117, 116
984200	109	A04092A	116, 117	A2H1	125	A4M9	125	A300	116, 117
984226	109	A04092B	116, 117	A2H4	125	A5A2	116, 117	A400	116, 117
984252	138	A04093	116, 117	A2H5	125	A5A5	116, 117	A500	116, 117
984254	116, 117	A04093A	116, 117	A2H9	125	A5A9	116, 117	A600	116, 117
1107832-6	115	A04901A	116, 117	A2K1	125	A5B1	116, 117	A615-1012	109
1107832-7	113	A059-114	116, 117(4)	A2K4	125	A5B2	116, 117	A725EH2AB1	116, 117
1107832-9	113	A059-117	138	A2K5	125	A5B5	116, 117	A800	125
1107832-10	113	A059-118	137	A2K9	125	A5C1	116, 117	A1000	125
1107832-11	113	A04093-X	116, 117	A2M1	125	A5C2	116, 117	A1946	116, 117
1440977	118	A04210-A	116, 117	A2M4	125	A5C5	116, 117	A10105	116, 117
1440977-1	118	A04212-B	116, 117	A2M5	125	A5C9	116, 117	A10113	116, 117
1470990	120	A04226	116(3)	A2M9	125	A5D1	116, 117	A10118	116, 117
1470990-1	120	A04230-A	116, 117	A3A1	116, 117	A5D2	116, 117	A10142	116, 117
1955486	116, 117	A04231-A	116, 117	A3A3	116, 117	A5D5	116, 117	A10164	116, 117
1951843	116, 117	A04233	116, 117	A3A5	116, 117	A5D9	116, 117	A10165	116, 117
1962594	116, 117	A04234-2	138	A3A9	116, 117	A5E1	116, 117	A10169	116, 117
2000625-36	116, 117	A04284-A	116, 117(4)	A3B1	116, 117	A5E2	116, 117	A21268	138
2000626-32	116, 117	A04294	116, 117	A3B3	116, 117	A5E5	116, 117	A36508	109
2000646-115	116, 117	A04294-1	116, 117	A3B5	116, 117	A5E9	116, 117	A36539	142
2000646-119	116, 117	A07	109	A3B9	116, 117	A5F1	116, 117	A42946	113
2000646-120	116, 117	A1A1	116, 117	A3C1	116, 117	A5F2	116, 117	AA50	116, 117
2000648-26	109, 110	A1A5	116, 117	A3C3	116, 117	A5F9	116, 117	AA100	116, 117
2000757	113	A1A9	116, 117	A3C5	116, 117	A5G1	116, 117	AA111	109
2000757-18	109	A1B	116, 117	A3C9	116, 117	A5G2	116, 117	AA112	109
2000757-79	113	A1B1	116, 117	A3D1	116, 117	A5G5	116, 117	AA113	109
20001786-134	109	A1B5	116, 117	A3D3	116, 117	A5G9	116, 117	AA116	109
20001786-139	114	A1B9	116, 117	A3D9	116, 117	A5H1	125	AA119	109
20001786-141	116, 117	A1C1	116, 117	A3E1	116, 117	A5H2	125	AA120	109
20001786-142	116, 117	A1C5	116, 117	A3E3	116, 117	A5H5	125	AA130	109
2001786-207	116(3)	A1C9	116, 117	A3E5	116, 117	A5H9	125	AA131	109
2002209-1	139	A1D1	116, 117	A3E9	116, 117	A5K1	125	AA134	109
2002331-46	143	A1D5	116, 117	A3F1	116, 117	A5K2	125	AA135	109
2002332-57	116, 117	A1D9	116, 117	A3F3	116, 117	A5K5	125	AA136	109
2002332-58	116, 117(4)	A1E1	116, 117	A3F5	116, 117	A5K9	125	AA137	109
2003073-68	116, 117	A1E5	116, 117	A3F9	116, 117	A5M1	125	AA149	109
2004107-40	113	A1E9	116, 117	A3G1	116, 117	A5M2	125	AA142	109
2004358-142	116, 117	A1F1	116, 117	A3G3	116, 117	A5M5	125	AA1Y5	109
2005779-26	138	A1F5	116, 117	A3G5	116, 117	A5M9	125	AA1Y8	109
2060041	116, 117	A1F9	116, 117	A3G9	116, 117	A7B	116, 117	AA1Y-22	116, 117
2092095-0001	109	A1G1	116, 117	A3H1	125	A7C	116, 117	AA1Y7	109
2092095-0007	109	A1G5	116, 117	A3H3	125	A7D	116, 117	AA1Y30	109
2092095-0708	112	A1G9	116, 117	A3H5	125	A7E	116, 117	AA1Y33	109
2495014	109	A1H	116, 117	A3H9	125	A7G	116, 117	AA1Y46	109
2495083	110	A1H1	116, 117	A3K1	125	A10B	116, 117	AA1Y139	109
2495084	109	A1H5	116, 117	A3K3	125	A10C	116, 117	AA218	116, 117
2495380	109	A1H9	116, 117	A3K5	125	A10D	116, 117	AC30	116, 117
4101685	116, 117	A1K1	125	A3K9	125	A10E	116, 117	AC50	116, 117
5300113-1	116, 117	A1K5	125	A3M1	125	A10M	116, 117	AC150	116, 117
5955749	116, 117	A1K9	125	A3M3	125	A10N	125	AD10	116, 117
6846503	116, 117	A1M1	125	A3M5	125	A10P	125	AD50	116, 117
7027005	116, 117	A1M5	125	A3M9	125	A13A2	116, 117	AD100	116, 117
7027023	116, 117	A1M9	125	A4A1	116, 117	A13A2	116, 117	AD150	116, 117
7043216	116, 117	A2A1	116, 117	A4A5	116, 117	A13B2	116, 117	AD200	116, 117
7043261	116, 117	A2A4	116, 117	A4A9	116, 117	A13C2	116, 117	AE10	116, 117
71773660	110	A2A5	116, 117	A4B1	116, 117	A13D2	116, 117	AE30	116, 117
7100628	116, 117	A2A9	116, 117	A4B5	116, 117	A13E2	116, 117	AE50	116, 117
7100630	116, 117	A2B1	116, 117	A4B9	116, 117	A13F2	116, 117	AE100	116, 117

DIODES and RECTIFIERS (cont'd)

Type To Be Replaced	Sylvania ECG Replacement	Type To Be Replaced	Sylvania ECG Replacement	Type To Be Replaced	Sylvania ECG Replacement	Type To Be Replaced	Sylvania ECG Replacement	Type To Be Replaced	Sylvania ECG Replacement
AE150	116, 117	AR19	116, 117	B2F1	116, 117	B5C9	116, 117	BD117	116, 117
AE200	116, 117	AR20	116, 117	B2F5	116, 117	B5D1	116, 117	BD127	116, 117
AFS-160-1017	109	AR21	116, 117	B2F9	116, 117	B5D5	116, 117	BE107	116, 117
AFS-160-1020	110	AR22	116, 117	B2G1	116, 117	B5D9	116, 117	BE117	116, 117
AFS-160-1021	116, 117(4)	AR23	125	B2G5	116, 117	B5E1	116, 117	BE127	116, 117
AG100D	116, 117	AR24	125	B2G9	116, 117	B5E5	116, 117	BR42	116, 117
AG100G	116, 117	AS-2	116, 117	B2H1	125	B5E9	116, 117	BR44	116, 117
AG100J	116, 117	AS-3	116, 117	B2H5	125	B5F1	116, 117	BR46	116, 117
AH805	125	AS-4	116, 117	B2H9	125	B5F5	116, 117	BR52	116, 117
AH810	125	AS-5	116, 117	B2K5	125	B5F9	116, 117	BY100	125
AH814	125	AS6	116, 117	B2K9	125	B5G1	116, 117	BY100S	125
AH815	125	AS11	116, 117	B2M1	125	B5G5	116, 117	BY101	116, 117
AH1005	125	AS-14	116, 117	B2M5	125	B5G9	116, 117	BY102	116, 117
AH1010	125	AS-15	116, 117	B2M9	125	B5H1	116, 117	BY103	125
AH1015	125	AV5	142	B3A1	116, 117	B5H5	125	BY104	125
AJ5	116, 117	AV10	147	B3A5	116, 117	B5H9	125	BY105	125
AJ10	116, 117	AV2012	142	B3A9	116, 117	B5K1	125	BY106	116, 117
AJ15	116, 117	AV2015	145	B3B1	116, 117	B5K5	125	BY107	116, 117
AJ20	116, 117	AV2027	146	B3B5	116, 117	B5K9	125	BY108	125
AJ25	116, 117	AV2033	147	B3B9	116, 117	B5M1	125	BY109	125
AJ30	116, 117	AV2055	148	B3C1	116, 117	B5M5	125	BY111	116, 117
AJ35	116, 117	AV2062	149	B3C5	116, 117	B5M9	125	BY112	116, 117
AJ40	116, 117	AV2082	150	B3C9	116, 117	B30	109	BY113	116, 117
AJ50	116, 117	AV2130	151	B3D1	116, 117	B30C250	116, 117	BY114	116, 117
AJ60	116, 117	AZ3.6	134	B3D5	116, 117	B30C250-1	116, 117	BY115	116, 117
AM005	116, 117	AZ5.1	135	B3D9	116, 117	B30C600	116, 117	BY116	116, 117
AM-010	116, 117	AZ5.6	136	B3E1	116, 117	B30C600CB	116, 117	BY117	116, 117
AM015	116, 117	AZ6.2	137	B3E5	116, 117	B30C1000	116, 117	BY118	125
AM-020	116, 117	AZ7	144	B3E9	116, 117	B31	116, 117	BY119	125
AM-025	116, 117	AZ10	140	B3F1	116, 117	B35C600	116, 117	BY121	116, 117
AM-030	116, 117	AZ15	145	B3F5	116, 117	B46-110	113	BY122	116, 117(4)
AM-035	116, 117	AZ27	146	B3F9	116, 117	B50C300	116, 117(4)	BY123	116, 117
AM040	116, 117	B1A1	116, 117	B3G1	116, 117	B66X0035-001	118	BY124	116, 117
AM050	116, 117	B1A5	116, 117	B3G5	116, 117	B66X0036-001	119	BY125	116, 117
AM-060	116, 117	B1A9	116, 117	B3G9	116, 117	B66X0041-001	120	BY126	116, 117
AM-3	116, 117	B1B	116, 117	B3H1	125	B200C40	116, 117	BY127	116, 117
AM13	116, 117	B1B1	116, 117	B3H5	125	B250C7K4S	116, 117	BY128	125
AM21	116, 117	B1B5	116, 117	B3H9	125	B250C75	116, 117	BY129	125
AM22	116, 117	B1B9	116, 117	B3K5	125	B250C75K4	116, 117	BY130	116, 117
AM23	116, 117	B1C1	116, 117	B3K9	125	B250C75K41	116, 117	BY141	116, 117
AM24	116, 117	B1C5	116, 117	B3M1	125	B250C75K45	116, 117	BY153	116, 117
AM32	116, 117	B1C9	116, 117	B3M5	125	B250C100	116, 117	BY1001	125
AM33	116, 117	B1D1	116, 117	B3M9	125	B250C100TD	116, 117	BY1002	125
AM42	116, 117	B1D5	116, 117	B4A1	116, 117	B250C125	116, 117	BY1101	125
AM43	116, 117	B1D9	116, 117	B4A5	116, 117	B250C125K4	116, 117	BY1102	125
AM53	116, 117	B1E1	116, 117	B4A9	116, 117	B250C125N2	116, 117	BY1201	125
AM62	116, 117	B1E5	116, 117	B4B1	116, 117	B250C125X4	116, 117	BY1202	125
AM63	116, 117	B1E9	116, 117	B4B5	116, 117	B250C150	116, 117	BYX10	125
AM65	116, 117	B1F1	116, 117	B4B9	116, 117	B250C150K4	116, 117	BYX22/200	116, 117
AM66	116, 117	B1F5	116, 117	B4C1	116, 117	B294	116, 117	BYX22/400	116, 117
AM300	116, 117	B1F9	116, 117	B4C5	116, 117	B601-1011	109	BYX22/600	116, 117
AM300A	116, 117	B1G1	116, 117	B4C9	116, 117	B601-1012	116, 117	BYX22/800	125
AM301	116, 117	B1G5	116, 117	B4D1	116, 117	B36564	116, 117	BYY31	116, 117
AM301A	116, 117	B1G9	116, 117	B4D5	116, 117	BA100	116, 117	BYY32	116, 117
AM302A	116, 117	B1H	116, 117	B4D9	116, 117	BA104	116, 117	BYY33	116, 117
AM303	116, 117	B1H1	125	B4E1	116, 117	BA105	116, 117	BYY34	116, 117
AM303A	116, 117	B1H5	125	B4E5	116, 117	BA108	116, 117	BYY35	116, 117
AM304	116, 117	B1H9	125	B4E9	116, 117	BA114	116, 117	BYY36	116, 117
AM304A	116, 117	B1K1	125	B4F1	116, 117	BA119	116, 117	BYY37	125
AM305A	116, 117	B1K5	125	B4F5	116, 117	BA120	116, 117	BYY89	116, 117
AM306	116, 117	B1K9	125	B4F9	116, 117	BA128	116, 117	BYY91	125
AM306A	116, 117	B1M1	125	B4G1	116, 117	BA129	116, 117	BZ3.6	134
AM307	116, 117	B1M5	125	B4G5	116, 117	BA130	116, 117	BZ5.1	135
AM307A	116, 117	B1M9	125	B4G9	116, 117	BA153	116, 117	BZ5.6	136
AM308A	116, 117	B28	109	B4H1	125	BAY15	125	BZ6.2	137
AM405	116, 117	B2A1	116, 117	B4H5	125	BAY16	125	BZ100	135
AM410	116, 117	B2A5	116, 117	B4H9	125	BAY17	116, 117	BZ101	137
AM415	116, 117	B2A9	116, 117	B4K1	125	BAY23	125	BZ102	139
AM420	116, 117	B2B1	116, 117	B4K5	125	BAY44	116, 117	BZ103	142
AM425	116, 117	B2B5	116, 117	B4K9	125	BAY64	116, 117	BZ104	145
AM430	116, 117	B2B9	116, 117	B4M1	125	BAY86	116, 117	BZ105	146
AM435	116, 117	B2C1	116, 117	B4M5	125	BAY87	116, 117	BZ106	147
AM440	116, 117	B2C5	116, 117	B4M9	125	BAY90	125	BZ107	135
AM445	116, 117	B2C9	116, 117	B5A1	116, 117	BB1A	116, 117	BZ108	136
AM450	116, 117	B2D1	116, 117	B5A5	116, 117	BB107	116, 117	BZ109	146
AM460	116, 117	B2D5	116, 117	B5A9	116, 117	BB117	116, 117	BZ110	149
AR7C	116, 117	B2D9	116, 117	B5B1	116, 117	BB127	116, 117	BZ111	150
AR16	116, 117	B2E1	116, 117	B5B5	116, 117	BC207	116, 117	BZ112	142
AR17	116, 117	B2E5	116, 117	B5C1	116, 117	BC307	116, 117	BZ113	145
AR18	116, 117	B2E9	116, 117	B5C5	116, 117	BD107	116, 117	BZ114	147

## DIODES and RECTIFIERS (cont'd)

Type To Be Replaced	Sylvania ECG Replacement	Type To Be Replaced	Sylvania ECG Replacement	Type To Be Replaced	Sylvania ECG Replacement	Type To Be Replaced	Sylvania ECG Replacement	Type To Be Replaced	Sylvania ECG Replacement
BZY57	135	CD31-00007	136	CER72D	125	CL7	125	C11A	122
BZY58	136	CD31-00008	137	CER72F	125	CL8	125	C11A-U	122
BZY65	135	CD31-00012	139	CER73	125	CM	113	C11B	122
BZY69	142	CD31-00015	142	CER73A	125	COD1531	116, 117	C15A-U	122
BZY83/C5V1	135	CD31-00017	145	CER73B	125	COD1532	116, 117	C20A-U	122
BZY83/C5V6	136	CD31-00023	146	CER73C	125	COD1533	116, 117	C1083B	113
BZY83/C10	140	CD31-10361	146	CER73F	125	COD1534	116, 117	C10159	116, 117
BZY83/D5V6	136	CD31-10365	145	CER73F	125	COD1535	116, 117	C21383	140
BZY83/D10	140	CD31-12019	139	CER500	116, 117	COD1536	116, 117	C23680	116, 117
BZY83/D15	145	CD31-12022	142	CER500B	116, 117	COD1537	125	D01-100	116, 117
BZY85/C3V6	134	CD31-12024	145	CER500C	116, 117	COD1538	125	D1-52S	116, 117
BZY85/C5V1	135	CD31-12030	146	CER670	116, 117	COD1551	116, 117	D1F	149
BZY85/C5V6	136	CD31-12032	147	CER670A	116, 117	COD1552	116, 117	D1G	139
BZY85/C10	140	CD1111	116, 117	CER670B	116, 117	COD1553	116, 117	D1H	117, 117
BZY85/C15	145	CD1112	116, 117	CER670C	116, 117	COD1554	116, 117	D1R35	109, 110
BZY85/C27	146	CD1113	116, 117	CER680	116, 117	COD1555	116, 117	D1R39	109, 110
BZY85/C33	147	CD1114	116, 117	CER680A	116, 117	COD1556	116, 117	D1T	144
BZY85/D5V6	136	CD1115	116, 117	CER680B	116, 117	COD1611	116, 117	D1W	146
BZY85/D10	140	CD1116	116, 117	CER680C	116, 117	COD1612	116, 117	D1Z RED	144
BZY85/D15	145	CD1122	116, 117	CER690	116, 117	COD1613	116, 117	D1Z YEL	145
BZY88/C5V1	135	CD1123	116, 117	CER690	116, 117	COD1614	116, 117	D1Z BLU	145
BZY88/C5V6	136	CD1124	116, 117	CER690B	116, 117	COD1615	116, 117	D1Z PUR	143
BZY88/C6V2	137	CD1125	116, 117	CER700	116, 117	COD1616	116, 117	D2G	141
BZY92/C5V1	135	CD1126	116, 117	CER700A	116, 117	COD1617	116, 117	D2H	116, 117
BZY92/C5V6	136	CD1127	116, 117	CER700B	116, 117	COD1618	125	D3R38	116, 117
BZY92/C15	145	CD1141	116, 117	CER700C	116, 117	COD1-537	125	D3R39	116, 117
BZY92/C27	146	CD1142	116, 117	CER710	116, 117	COD1-538	125	D4R39	116, 117
BZY92/C33	147	CD1143	116, 117	CER710A	116, 117	COD1-517	125	D4R39	116, 117
BZY94/C12	142	CD1147	116, 117	CER710B	116, 117	COD1-618	125	D4	113
BZY94/C15	145	CD1148	116, 117	CER710C	116, 117	COD1-6045	116, 117	D5R35	116, 117
BZY94/C27	146	CD1149	116, 117	CER720	125	COD1-6046	116, 117	D5R39	116, 117
BZY94/C33	147	CD1151	116, 117	CER720A	125	COD1-6047	116, 117	D6HZ	116, 117
BZY94/C62	149	CD3122	135	CER720B	125	COD1-6048	116, 117	D5	114
C1B	116, 117	CD3171	149	CER720C	125	COD15556	116, 117	D6	115
C1H	116, 117	CD3174	150	CER730	125	COD15524	116, 117	D7	115
C11A	122	CD4116	142	CER730A	125	COD15544	116, 117	D8HZ	125
C11B	122	CD4117	142	CER730B	125	COD15564	116, 117	D15A	116, 117
C11F	122	CD4118	142	CER730C	125	COD15564	116, 117	D15C	116, 117
C60	109	CD4121	142	CF102DA	116, 117	CP102	125	D16U3	113
CA1010	116, 117	CD4122	142	CF102PA	125	CP102BA	116, 117	D16U4	113
C11SIC1E1C	116, 117	CD13332	116, 117	CF102RA	125	CP102DA	116, 117	D18	116, 117
CA10	116, 117	CD13333	116, 117	CG12E	109	CP102FA	116, 117	D25	116, 117
CA20	116, 117	CD13334	116, 117	CG64H	109	CP102HA	116, 117	D25A	116, 117
CA50	116, 117	CD13335	116, 117	CG65H	109	CP102KA	116, 117	D25B	116, 117
CA100	116, 117	CD13336	116, 117	CG66H	109	CP102MA	116, 117	D25C	116, 117
CA102BA	116, 117	CD13337	116, 117	CG67H	109	CP102PA	125	D28	116, 117
CA102DA	116, 117	CD13338	116, 117	CG74H	109	CP102RA	125	D30	116, 117
CA102FA	116, 117	CD13339	116, 117	CG86H	109	CP102VA	125	D45C	116, 117
CA102HA	116, 117	CE502	116, 117	CGD462	109	CP103	125	D45CZ	116, 117
CA102KA	116, 117	CE504	116, 117	CGD685	109	CP152VA	125	D48	116, 117
CA102MA	116, 117	CE506	116, 117	CGD1029	109	CR1034	116, 117	D50	116, 117
CA102PA	125	CE508	125	CH4A423.6	134	CS131D	116, 117	D51	113
CA102RA	125	CE510	125	CH4A425.6	135	CT16XT	113	D65C	116, 117
CA102VA	125	CE6050	116, 117	CH4A425.6	136	CT100	116, 117	D68	116, 117
CA150	116, 117	CER6B	116, 117	CHAZ6.2	137	CT200	116, 117	D85C	125
CA152VA	125	CER67	116, 117	CHAZ6.2A	137	CT300	116, 117	D88	116, 117
CA200	116, 117	CER67A	116, 117	CHZ10	140	CT461	109	D100	116, 117
CA250	116, 117	CER67B	116, 117	CHZ12	130	CT600	116, 117	D105C	116, 117
CA1020A	116, 117	CER67C	116, 117	CHZ10A	140	CTN200	116, 117	D108	125
CB10	116, 117	CER68	116, 117	CHZ3.6	134	CTP461	109	D124	116, 117(4)
CB20	116, 117	CER68A	116, 117	CHMZ5.1	135	CTP573	109	D145S	116, 117
CB50	116, 117	CER68B	116, 117	CHMZ5.6	136	CV425	109	D145S	116, 117
CB100	116, 117	CER68C	116, 117	CH1190	116, 117	CV442	109	D200	116, 117
CB150	116, 117	CER69	116, 117	CK705	109	CX-0036	109	D300	116, 117
CB163	109	CER69A	116, 117	CK706	109	CX-0037	116, 117	D400	116, 117
CB200	116, 117	CER69B	116, 117	CK706A	109	CX-0039	116, 117	D500	116, 117
CB250	116, 117	CER69C	116, 117	CK706P	109	CX-0040	116, 117	D600	116, 117
CC102DA	116, 117	CER70	116, 117	CK710	111, 112	CX9001	116, 117	D800	125
CC102FA	116, 117	CER70A	116, 117	CK715	109	CY40	116, 117	D1000	125
CC102HA	116, 117	CER70B	116, 117	CK731	111, 112	CY50	116, 117	D1172S	116, 117
CC102KA	116, 117	CER70C	116, 117	CL010	116, 117	CY80	125	D3530	112
CC102MA	116, 117	CER71	116, 117	CL025	116, 117	CY100	125	D6462	109
CC102PA	125	CER71A	116, 117	CL05	116, 117	CZD010	140	D6623	116, 117
CC102RA	125	CER71B	116, 117	CL1	116, 117	CZD012-5	142	D6623A	116, 117
CC102VA	125	CER71C	116, 117	CL1.5	116, 117	CZD014	144	D6624	116, 117
CC152VA	125	CER72	125	CL2	116, 117	CZD014-5	144	D6624A	116, 117
CD0014	109	CER72A	125	CL3	116, 117	CZD015	145	D6625	116, 117
CD31-00002	134	CER72B	125	CL4	116, 117	CZD015-5	145	D6625A	116, 117
CD31-00006	135	CER72C	125	CL5	116, 117	CZD0105	140	D6726	109
				CL6	116, 117	C1.0E2	125	D10167	116, 117

DIODES and RECTIFIERS (cont'd)

Type To Be Replaced	Sylvania ECG Replacement	Type To Be Replaced	Sylvania ECG Replacement	Type To Be Replaced	Sylvania ECG Replacement	Type To Be Replaced	Sylvania ECG Replacement	Type To Be Replaced	Sylvania ECG Replacement
D10168	116, 117	DR351	109	E1018N	116, 117	ED3000A	116, 117	ER101	116, 117
DA000	116, 117	DR352	109	E1410	116, 117	ED3000B	116, 117	ER102	117
DA001	116, 117	DR365	109	E1411	116, 117	ED3001	116, 117	ER102D	116, 117
DA002	116, 117	DR385	109	E1412	116, 117	ED3001A	116, 117	ER103D	116, 117
DA058	125	DR400	116, 117	E1413	116, 117	ED3001B	116, 117	ER103E	116, 117
DA90	109	DR426	109	E1415	116, 117	ED3002	116, 117	ER104D	116, 117
DA2068	125	DR427	116, 117	E1440	116, 117	ED3002A	116, 117	ER105D	116, 117
DC6V	127	DR434	109	E2484	110	ED3002B	116, 117	ER106D	116, 117
DD-000	116, 117	DR435	116, 117	E2486	137	ED3003	116, 117	ER107D	125
DD-003	116, 117	DR449	109	E3006	116, 117	ED3003A	116, 117	ER108D	125
DD-006	116, 117	DR464	109	E10116	116, 117	ED3003B	116, 117	ER181	116, 117
DD-007	116, 117	DR500	116, 117	E10157	116, 117	ED3003S	116, 117	ER182	116, 117
DD-04	113	DR600	116, 117	EA005	116, 117	ED3004	116, 117	ER183	116, 117
DD-05	114	DR668	116, 117	EA-0015	116, 117	ED3004A	116, 117	ER184	116, 117
DD-06	115	DR669	116, 117	EA-0016	116, 117	ED3004B	116, 117	ER185	116, 117
DD-055	116, 117	DR670	116, 117	EA-0031	116, 117	ED3005	116, 117	ER186	125
DD175C	116, 117	DR671	116, 117	EA-010	116, 117	ED3005A	116, 117	ER187	125
DD176C	116, 117	DR695	116, 117	EA-020	116, 117	ED3005B	116, 117	ER201	116, 117
DD177C	116, 117	DR698	116, 117	EA-030	116, 117	ED3006	116, 117	ER301	116, 117
DD236	116, 117	DR699	116, 117	EA040	116, 117	ED3006A	116, 117	ER401	116, 117
DD268	116, 117	DR700	125	EA050	116, 117	ED3006B	116, 117	ER501	116, 117
DD268	125	DR800	125	EA060	116, 117	ED3007	125	ERD300	116, 117
DD2066	116, 117	DR826	116, 117	EA080	116, 117	ED3007A	125	ER308	125
DD2068	125	DR848	116, 117	EA16X1	109	ED3007B	125	ER310	125
DDMV-1	109	DR863	116, 117	EA16X4	141	ED3008	125	ER381	116, 117
DDMV-2	109	DR900	125	EA16X5	109	ED3008A	125	ERD400	116, 117
DE14	116, 117	DR1000	125	EA16X8	116, 117	ED3008B	125	ER601	116, 117
DE14A	116, 117	DR5101	116, 117	EA16X9	109	ED3009	125	ER801	125
DE16	116, 117	DR5102	116, 117	EA16X21	116, 117	ED3009A	125	ER1001	125
DE16A	116, 117	DR5102	116, 117	EA57X1	116, 117	ED3009B	125	ERD700	125
DER1	125	DRS104	116, 117	EA57X3	116, 117	ED3010	125	ERD800	125
DGINR	116, 117	DRS106	116, 117	EA57X8	116, 117	ED3010A	125	ERD900	125
DH4R2	116, 117	DRS107	125	EA57X10	116, 117	ED3010B	125	ERD1000	125
DH14	116, 117	DS1K-7D	116, 117	EA57X11	116, 117	EER600-2	117, 116	ES16X2	109
DH14A	116, 117	DS1P	116, 117	EA75X1	116, 117	EF100	125	ES16X21	110
DH16	116, 117	DS2N	116, 117	EA100	125	EG100	125	ES57X1	116, 117
DH16A	116, 117	DS13	116, 117	EA1072	116, 117	EH42C11	116(3)	ES57X2	116, 117
DHD0805	116, 117	DS14	116, 117	EA1123	109	EM1J2	116, 117	ESKE40C500	116, 117
DHD0806	109	DS16E	116, 117	EA1318	142	EM401	116, 117	ESKE125C500	125
DI-7	116, 117	DS17	116, 117(2)	EA1448	116, 117	EM402	116, 117	ET16X1	109
DI-42S	116, 117	DS31	110	EA5711	116, 117	EM403	116, 117	ET16X7	113
DI-46	116, 117	DS39	110	EC100	125	EM404	116, 117	ET16X10	113
DI-52S	116, 117	DS49	139	EC401	116, 117	EM405	116, 117	ET16X11	113
DI55	116, 117	DS-0065	116, 117	EC402	116, 117	EM406	116, 117	ET16X14	112
DI-56	116, 117	DS-1K	116, 117	ECR-600-2	116, 117	EM407	116, 117	ET55-25	116, 117
DI71	116, 117	DS-1M	116, 117	ED-4	116, 117	EM408	116, 117	ET55X25	116, 117
DI-72S	116, 117	DS-13	116, 117	ED-5	116, 117	EM410	116, 117	ET57X25	116, 117
DI-645	116, 117	DS-27	109	ED-6	116, 117	EM501	116, 117	ET57X29	116, 117
DI-646	116, 117	DU400	116, 117	ED-7	116, 117	EM502	116, 117	ET57X30	116, 117
D1647	116, 117	DU600	116, 117	ED1804	116, 117	EM503	116, 117	ET57X31	119
D1648	116, 117	DU800	125	ED1892	116, 117	EM504	116, 117	ET57X32	118
D1649	116, 117	DU1000	125	ED2106	116, 117	EM507	125	ET57X33	116, 117
D1650	125	DZ12A	142	ED2107	116, 117	EM508	125	ET57X35	116, 117
D1705	116, 117	DZ15A	145	ED2108	116, 117	EM510	125	ET57X39	116, 117
DI-1649	116, 117	DZ27A	146	ED2109	116, 117	EO-704	116, 117	ET57X40	116, 117
DIB	113	DZ33A	147	ED2110	116, 117	EP16X20	109	ET200	116, 117
DIC	113	DZ32A	150	ED2842	116, 117	EP16X21	116, 117	ET400	116, 117
DICR1	125	DXS20	116, 117	ED2843	116, 117	EP57X1	116, 117	ET600	116, 117
DID	125	E-075L	116, 117	ED2844	116, 117	EP200	116, 117	ETD-1N60	109
DIE	116, 117	E1	116, 117	ED2845	116, 117	EP400	116, 117	ETD-10D1	116, 117
DIJ	116, 117	E1M3	125	ED2846	116, 117	EP600	116, 117	ETD-10D2	116, 117
DIK	125	E1N3	125	ED2847	125	EP800	125	ETD-SD46	109
DIL	116, 117	E14C350	116, 117	ED2848	125	EP1000	125	EU16X1	109, 110
DIRM	136	E2	116, 117	ED2849	125	EP-1259	116, 117	EU16X4	112
DIS	143	E25C5	116, 117	ED2910	125	ER1	116, 117	EU16X19	110
DIS-1S	116, 117	E125C200	116, 117	ED2911	125	ER2	116, 117	EU57X31	119
DIT	144	E3	116, 117	ED2912	125	ER-11	116, 117	EU57X32	118
DK19	109	E5	116, 117	ED2913	125	ER12	116, 117	EU57X38	120
DK20	109	E6	116, 117	ED2914	116, 117	ER21	116, 117	EU57X40	116, 117
DK21	109	E8	125	ED2915	116, 117	ER22	116, 117	EVRA	136
DF100	125	E9	125	ED2916	116, 117	ER-31	116, 117	EVRA4	136
DR1	116, 117	E10	125	ED2917	116, 117	ER-41	116, 117	EVRA8	136
DR2	116, 117	E84	140	ED2918	116, 117	ER42	116, 117	EVR5	137
DR3	116, 117	E135	116, 117	ED2919	116, 117	ER51	116, 117	EVR5A	137
DR4	116, 117	E143	116, 117	ED2920	116, 117	ER57X2	116, 117	EVR5B	137
DR5	116, 117	E146	116, 117	ED2921	116, 117	ER57X3	116, 117	EVR9	139
DR100	116, 117	E150L	116, 117	ED2922	125	ER57X4	116, 117	EVR9A	139
DR200	116, 117	E262	142	ED2923	125	ER61	116, 117	EVR9B	139
DR291	109	E300L	116, 117	ED2924	125	ER62	116, 117	EVR12	142
DR300	116, 117	E650L	116, 117	ED3000	116, 117	ER81	125	EVR12A	142

## DIODES and RECTIFIERS (cont'd)

Type To Be Replaced	Sylvania ECG Replacement	Type To Be Replaced	Sylvania ECG Replacement	Type To Be Replaced	Sylvania ECG Replacement	Type To Be Replaced	Sylvania ECG Replacement	Type To Be Replaced	Sylvania ECG Replacement
EVR12B	142	FW200	116, 117	G222	116, 117	GSM54	116, 117	HG5006	109
EVR15	145	FW400	116, 117	G296	116, 117	GSM482	116, 117	HG5007	109
EVR15A	145	FW500	116, 117	G409	109	GSM483	116, 117	HG5008	109
EVR15B	145	FW600	116, 117	G498	109	GSR1	125	HG5009	109
EVR27	146	FW600A	116, 117	G580	109	GZ5.1	135	HG5078	109
EVR27A	146	FWL100	116, 117	G657	116, 117	GZ6.2	137	HG5079	109
EVR27B	146	FWL200	116, 117	G659	116, 117	GZ9.1	139	HG5085	109
EVR82	150	FW3300	116, 117	G700	116, 117	GZ27	146	HG5808	109
EVR82A	150	FZ3.6T5	134	G701	116, 117	H50	116, 117	HGR1	116, 117
EVR82B	150	FZ3.6T10	134	G702	116, 117	H100	116, 117	HGR2	116, 117
EVR110	151	FZ5.1T5	135	G766	109	H200	116, 117	HGR3	116, 117
EVR110A	151	FZ5.1T10	135	G788	109	H300	116, 117	HGR4	116, 117
EVR110B	151	FZ5.6T5	136	G789	109	H400	116, 117	HR5ABE	116, 117
F-05	116, 117	FZ5.6T10	136	G790	109	H500	116, 117	HR10	116, 117
F1	116, 117	FZ6.2T10	137	G814	109	H600	116, 117	HR11	116, 117
F2	116, 117	FZ12A	142	G815	109	H800	125	HR13	116, 117
F3	116, 117	FZ12T5	142	G816	109	H-881	125	HS-7/1	118
F4	116, 117	FZ12T10	142	G820	109	H1000	125	HS-7/17N	118
F5	116, 117	FZ14T5	144	G821	109	H8287	109, 110	HS-8/1	118
F6	116, 117	FZ14T10	144	G822	109	H8287-4	109, 110	HS133	111, 112
F8	125	FZ15A	145	G823	109	HA50	116, 117	HS1001	116, 117
F10	125	FZ15T5	145	G824	109	HA100	116, 117	HS1002	116, 117
F16	137	FZ15T10	145	G825	109	HA200	116, 117	HS1003	116, 117
F20-1010	109	FZ27A	146	G844	109	HA300	116, 117	HS1007	116, 117
F20-1012	109	FZ27T5	146	G845	109	HA400	116, 117	HS1008	116, 117
F20-1013	109	FZ27T10	146	G846	109	HA500	116, 117	HS1009	116, 117
F20-1014	109	FZ33A	147	G847	109	HA600	116, 117	HS1010	116, 117
F20-1015	116, 117	FZ82A	150	G868	109	HA800	125	HS1011	116, 117
F20-1016	116, 117	G01	116, 117	G869	109	HA1000	125	HS1012	116, 117
F136	109	G01A	111, 112	G10119	116, 117	HA1010	116, 117	HS1020	116, 117
F215-1010	109	G02	116, 117	GD1E	109	HAR15	116, 117	HS2036	134
F215-1012	109	G1	116, 117	GD1P	109	HAR20	116, 117	HS2051	135
F215-1013	109	G1HA	109	GD1Q	109	H82	116, 117	HS2056	136
F215-1014	109	G2	116, 117	GD4E	109	H83	116, 117	HS2062	137
F215-1016	116, 117	G3	116, 117	GD5E	109	HC30	116, 117	HS2100	140
F215-1017	116, 117	G4	116, 117	GD6E	109	HC67	116, 117	HS2120	142
F10124	116, 117	G5	116, 117	GD8E	109	HC68	116, 117	HS2150	145
F10148	116, 117	G5C	109	GD11E	116, 117	HC69	116, 117	HS2270	146
F20303	109	G5F	109	GD12	116, 117	HC71	116, 117	HS2330	146
FA4	116, 117	G5K	109	GD12E	116, 117	HC72	125	HS3103	116, 117
FA6	116, 117	G5.1T5	135	GD13E	109	HC73	125	HS3104	116, 117
FA8	125	G5.1T10	135	GD72E/3	116, 117	HC80	116, 117	HS3108	125
FA8005	141	G5.1T20	135	GD72E/4	116, 117	HC500	116, 117	HS3110	125
FA8006	141	G5.6T5	136	GD72E/5	116, 117	HC670	116, 117	HS7036	134
FA8007	141	G5.6T10	136	GD73E/3	109	HC680	116, 117	HS7051	135
FA8008	141	G5.6T20	136	GD73E/4	109	HC700	116, 117	HS7056	136
FA8009	145	G6	116, 117	GD73E/5	109	HC710	116, 117	HS7062	137
FA8010	145	G7	111, 112	GD74E/4	109	HC720	125	HS7100	140
FA8011	145	G7A	111, 112	GD74E/5	109	HC730	125	HS7120	142
FA8012	145	G7D	109	GD400	109	HCV	116, 117	HS7150	145
FD3	116, 117	G7E	109	GD401	109	HD6865	116, 117	HS7270	146
FD6	116, 117	G7F	109	GD402	109	HD1000303	109, 110	HS7300	147
FD222	116, 117	G7G	109	GD403	109	HD1000309	138	HV15	109
FD333	116, 117	G8	125	GD404	109	HD2000110	116, 117	HW8.2A	139
FD1599	116, 117	G9.1T5	139	GD405	109	HE-1N34A	109	HW9.1	139
FD1708	114	G9.1T10	139	GD406	109	HE-1N60	109	HW9.1A	139
FD3389	116, 117	G9.1T20	139	GD409	109	HE-1S188	109	HW9.1B	139
FD6451	109	G10	125	GD663	109	HE-1S426	109	HW12	142
FDH600	116, 117	G12T5	142	GE42-7	116, 117	HE-1S446	109	HW12A	142
FM1J2	125	G12T10	142	GE-CR1	118	HE-SD1	116, 117	HW12B	142
FR-1	116, 117	G12T20	142	GE-CR2	119	HEP154	116, 117	HW15	145
FR-1M	116, 117	G15T10	145	GE-CR3	120	HEP156	116, 117	HW15A	145
FR-1P	116, 117	G15T20	145	GE-504	116, 117	HEP157	116, 117	HW15B	145
FR-10	125	G27T5	146	GE-504A	116, 117	HEP158	116, 117	HW27	146
FR-1033	118	G27T10	146	GE505	116, 117	HEP159	125	HW27A	146
FSA1169	115	G27T20	146	GE509A	125	HEP160	125	HW27B	146
FSA1177	113	G100B	116, 117	GE-X1	122	HEP165	113	HW33	147
FSA1178	113	G100D	116, 117	GE-X11	140	HEP166	115	HW33A	147
FSA1202	115	G100G	116, 117	GE-X36	116, 117	HEP300	122	HW33B	147
FSP288-1	116, 117	G100J	116, 117	GEX-66	116, 117	HEP302	122	HW62	149
FST2	116, 117	G100K	125	GJ4M	116, 117	HF-0SW05	116, 117	HW62A	149
FST3	116, 117	G100M	125	GMIJ2	125	HFSD1	116, 117	HW62B	149
FT-1	116, 117	G130	116, 117	GP230	116, 117	HF-SD-1A	116, 117	HW82	150
FT1N	116, 117	G156	109	GP250	116, 117	HFSD1B	116, 117	HW82A	150
FT10	125	G157	109	GPM1NA	109	HFSD1Z	116, 117	HW82B	150
FU1K	116, 117	G158	109	GPM1NB	109	HF-SG005	116, 117	IR1601	122
FU10	116, 117	G159	109	GPM2NA	109	HFOW05	116, 117	IR1602	122
FV21	138	G198	109	GSM51	116, 117	HG1090	109	IR1772	122
FV22	137	G199	109	GSM52	116, 117	HG5002	109	IR1774	122
FW100	116, 117	G200	109	GSM53	116, 117	HG5004	109	IRFE100	133



DIODES and RECTIFIERS (cont'd)

Type To Be Replaced	Sylvania ECC Replacement	Type To Be Replaced	Sylvania ECC Replacement	Type To Be Replaced	Sylvania ECC Replacement	Type To Be Replaced	Sylvania ECC Replacement	Type To Be Replaced	Sylvania ECC Replacement
IT23	109	K5E5	116, 117	LPM33A	147	M500	116, 117	MC930A	116, 117
IT23G	109	K5F5	116, 117	LPM62	149	M500A	116, 117	MC930B	116, 117
J24567	110	K5G5	116, 117	LPM62A	149	M500B	116, 117	MC935	116, 117
J24570	116, 117	K5H5	125	LPM82	150	M500C	116, 117	MC940	116, 117
JAM702C	116, 117	K5K5	125	LPM82A	150	M500D	116, 117	MC940A	116, 117
JB-BB1A	116, 117(4)	K5M5	125	LPM110	151	M670	116, 117	MC970	125
JB16C4	116, 117(4)	K6	109	LPM110A	151	M670A	116, 117	MC970A	125
JCK505	116, 117	K34S747	111, 112	LPZT12	142	M670B	116, 117	MC980	125
JCN1	116, 117	K60	109	LPZT15	145	M670C	116, 117	MC980A	125
JCN2	116, 117	K112C	113	LPZT27	146	M680	116, 117	MC990	125
JCN-3	116, 117	K115J510-1	113	LPZT33	147	M680A	116, 117	MC990A	125
JCN-4	116, 117	K115J510-2(WT16X7)	113	LR51CH	135	M680B	116, 117	MC19	116, 117
JCN5	116, 117	K115J511-2	109	LR56CH	135	M680C	116, 117	MC100	125
JCN7	125	K117J460-1	113	LR150CH	145	M690	116, 117	MC100A	125
JCV-2	116, 117	K117J460-2	113	LZ5.6	136	M690A	116, 117	MC170	116, 117
JCV-3	116, 117	K118J966-1(WT16X9)	114	LZ10	140	M690B	116, 117	MC456	116, 117
JCV7	125	K118J966-2	115	LRR-50	116, 117	M690C	116, 117	MC1520	116, 117
JD-BB1A	116, 117	K118J966-3(WT16X8)	115	LRR-100	116, 117	M700	116, 117	MC1521	116, 117
JDS01D	116, 117	K118J966-4	115	LRR-200	116, 117	M700A	116, 117	MC1522	116, 117
JP575005	110	K122	113	LRR-300	116, 117	M700B	116, 117	MC1523	116, 117
JP575995	110	K122J176-1	118	LRR-400	116, 117	M700C	116, 117	MC1524	116, 117
J241	109	K122J176-2	118	LRR-500	116, 117	M701B	116, 117	MC1527	125
J242	109	K122J177-P1	119	M-0027	116, 117	M702C	116, 117	MC1528	125
J243	109	K882	109	M1H	116, 117	M710	116, 117	MC1529	125
J2441	109	K1615	113	M4HZ	116, 117	M710A	116, 117	MC6007	136
KC06E11/8	116, 117	K1616	114	M4Z12	142	M710B	116, 117	MC6007A	136
KC08C11/8	116, 117	K17	115	M4Z12A	142	M710C	116, 117	MC6008	137
KC08C11/10	116, 117	KC0-8C22/1	116, 117(4)	M4Z15	145	M720	125	MC6008A	137
KC08C21/5	116, 117	KC0-6911/8	116, 117	M4Z27	146	M720A	125	MC6014	140
KC0911/8	116, 117	KC2D22/1	116, 117	M4Z33	147	M720B	125	MC6014A	140
KC1322/1	116, 117	KC24P11/1412/1	116(3)	M4Z62	149	M720C	125	MC6016	142
KD2100	122	KC24P12/1	116, 117(2)	M4Z62A	149	M730	125	MC6016A	142
KD2103	116, 117	KC13C22/1	116, 117	M4Z82	150	M730A	125	MC6018	145
KSKE40C200	116, 117	KD27	109	M4Z110	151	M730B	125	MC6018A	145
KSKE40C500	116, 117	KD2104	116, 117	M6HZ	116, 117	M730C	125	MC6024	146
K1A5	116, 117	KD2501	140	M8HZ	125	M4552	144	MC6024A	146
K1B5	116, 117	KD2503	137	M12	116, 117	M4659	144	MC6026	147
K1C5	116, 117	KD2504	139	M14	116, 117	M4663	147	MC6026A	147
K1D5	116, 117	KD2505	142	M22	116, 117	M4728	151	MC6107	136
K1E5	116, 117	KS31A	134	M34A	109	M4736	116, 117	MC6107A	136
K1E5	116, 117	KS35A	135	M42	116, 117	M4850	141	MC6108	137
K1G5	116, 117	KS35AF	135	M51	109	M4851	141	MC6108A	141
K1.3G22-1A	116, 117	KS37A	137	M60	109	M4858	147	MC6116	142
K1H5	125	KS42A	140	M62	116, 117	M8222	116, 117	MC6116A	142
K1K5	125	KS42B	140	M67	116, 117	M8482	116, 112	MC6118	145
K1M5	125	KS44A	142	M67A	116, 117	M8513	109	MC6118A	145
K2A5	116, 117	KS44B	142	M67B	116, 117	M9206	116, 117	MC6124	146
K2B5	116, 117	KS46	145	M67C	116, 117	M9312	116, 117	MC6124A	146
K2C5	116, 117	KS100A	145	M69	116, 117	M9314	116, 117	MC6126	147
K2D5	116, 117	KS120A	142	M68A	116, 117	M9317	116, 117	MC6126A	147
K2E5	116, 117	KS120B	142	M68B	116, 117	M9319	116, 117	MCR2305-4	122
K2F5	116, 117	KS150A	145	M68C	116, 117	M105064	120	MCV	116, 117
K2G5	116, 117	KS150B	145	M69	116, 117	M109474	113	MD04	116, 117
K2H5	125	KS051A	135	M69A	116, 117	M41223-2	116, 117	MD46	109
K2K5	125	KS056A	136	M69B	116, 117	MA2	116, 117	MD60	109
K2M5	125	KS056B	136	M69C	116, 117	MA-8	109	MD60A	109
K3	111, 112	KS062A	137	M70	116, 117	MA-23B	109	MD134	116, 117
K3B5	116, 117	KSKE12C500	125	M70A	116, 117	MA26	116, 117	MD135	116, 117
K3C5	116, 117	KSKE40C200	116, 117	M70B	116, 117	MA51A	109	MD136	116, 117
K3D5	116, 117	KSKE40C500	116, 117	M70C	116, 117	MA101	116, 117	MD137	116, 117
K3E	111, 112	KSKE125C200	125	M71	116, 117	MA102	116, 117	MD138	116, 117
K3F5	116, 117	KVR10	140	M71A	116, 117	MA110	116, 117	MD752	136
K3G5	116, 117	L3/2H	116, 117	M71B	116, 117	MA203	116, 117	MD752A	136
K3H5	125	L6/2H	116, 117	M71C	116, 117	MA211	116, 117	MD753	137
K3K5	116, 117	L8/2H	116, 117	M72	125	MA215	116, 117	MD753A	137
K3M5	125	LC0.09M11/3	116, 117	M72A	125	MA350	116, 117	MD757	139
K4A5	116, 117	LL-2	116, 117	M72B	125	MA351	116, 117	MD757A	139
K4B5	116, 117	LP4H	116, 117	M72C	125	MA900	109	MD759	142
K4C5	116, 117	LP2H	116, 117	M72D	125	MB01	116, 117	MD759A	142
K4D5	116, 117	LP3H	116, 117	M73	125	MC010	116, 117	MEZ5.6T5	136
K4E5	116, 117	LP4H	116, 117	M73A	125	MC015	116, 117	MEZ5.6T10	136
K4F5	116, 117	LPM9.1	139	M73B	125	MC020	116, 117	MEZ12T5	142
K4G5	116, 117	LPM9.1A	139	M73C	125	MC021	116, 117	MEZ12T10	142
K4H5	125	LPM12	142	M82	125	MC021A	116, 117	MEZ15T5	145
K4K5	125	LPM12A	142	M95	109	MC022	116, 117	MEZ15T10	145
K4M5	125	LPM15	145	M102	125	MC022A	116, 117	MEZ27T5	146
K5A5	116, 117	LPM15A	145	M124/779-1	116, 117	MC023	116, 117	MEZ27T10	146
K5B5	116, 117	LPM27	146	M135	138	MC023A	116, 117	MH67	116, 117
K5C5	116, 117	LPM27A	146	M150	116, 117	MC025	116, 117	MH68	116, 117
K5D5	116, 117	LPM33	147	M204B	116, 117(4)	MC030	116, 117	MH70	116, 117

## DIODES and RECTIFIERS (cont'd)

Type To Be Replaced	Sylvania ECG Replacement	Type To Be Replaced	Sylvania ECG Replacement	Type To Be Replaced	Sylvania ECG Replacement	Type To Be Replaced	Sylvania ECG Replacement	Type To Be Replaced	Sylvania ECG Replacement
MH71	116, 117	MZ12	142	OA73C	109	PA305	116, 117	PE405	116, 117
MH72	125	MZ12A	142	OA79	109	PA305A	116, 117	PE406	116, 117
MH500	116, 117	MZ18	142	OA81	109	PA310	116, 117	PE408	125
MH570	116, 117	MZ15A	145	OA80	109	PA310A	116, 117	PE410	125
MH680	116, 117	MZ15T20	145	OA91	109	PA315	116, 117	PE502	116, 117
MH700	116, 117	MZ27A	146	OA126/5	135	PA315A	116, 117	PE504	116, 117
MH710	116, 117	MZ33A	147	OA126/10	140	PA320	116, 117	PE506	116, 117
MH720	125	MZ82A	150	OA126/12	142	PA320A	116, 117	PE508	125
MH730	125	MZ500-5	134	OA126/14	144	PA320B	116, 117	PE510	125
MM0	116, 117	MZ500-9	135	OA127	116, 117	PA325	116, 117	PH9d522/1	116, 117(4)
MM2	116, 117	MZ500-10	136	OA128	116, 117	PA325A	116, 117	PH25C22/1	116, 117
MM3	116, 117	MZ390-15	139	OA129	116, 117	PA325B	116, 117	PH108	116, 117
MM4	116, 117	MZ500-16	140	OA130	116, 117	PA330	116, 117	PH109	125
MM5	116, 117	MZ500-18	142	OA131	116, 117	PA330A	116, 117	PH1021	116, 117
MM6	116, 117	MZ500-20	145	OA132	116, 117	PA330B	116, 117	PR515	135
MM7	125	MZ500-26	146	OA134Q	109	PA340	116, 117	PR605	135
MM8	125	MZ500-28	147	OA150	116, 117	PA340A	116, 117	PR617	142
MM9	125	MZ500-35	149	OA160	116, 117	PA340B	116, 117	PR620	145
MM10	125	MZ500-38	150	OA172	109	PA350	116, 117	PR804	135
MN34A	109	MZ605	137	OA174	109	PA350A	116, 117	PRC10A	122
MN51	109	MZ610	137	OA180	109	PA360	117, 116	PRC15A	122
MN60	109	MZ620	137	OA200	116, 117	PA360A	116, 117	PRC20A	122
MP-01	116, 117	MZ640	137	OA202	116, 117	PA380	125	PR53017	135
MP100	116, 117	MZ1005	135	OA210	116, 117	PA400	116, 117	PS005	116, 117
MP225	116, 117	MZ1010	140	OA211	116, 117	PA600	116, 117	PS010	116, 117
MP300	116, 117	MZ1014	144	OA214	116, 117	PA10556	116, 117	PS015	116, 117
MP400	116, 117	N2A	109	OAZ201	135	PBE3322	109	PS020	116, 117
MP500	116, 117	N48	109	OAZ202	136	PC0211/2	116, 117	PS025	116, 117
MP600	116, 117	NA13	116, 117	OAZ209	135	PD101	116, 117	PS030	116, 117
MPX-25	116, 117	NA21	116, 117	OAZ213	142	PD102	116, 117	PS035	116, 117
MPX215	116, 117	NA22	116, 117	OAZ242	136	PD103	116, 117	PS040	116, 117
MQ3/2	116, 117	NA25	116, 117	OAZ269	135	PD104	116, 117	PS050	116, 117
MQ6/2	116, 117	NA32	116, 117	OSS16308	116, 117	PD105	116, 117	PS060	117, 116
MQ8/2	116, 117	NA33	116, 117	OSS16685	109	PD106	116, 117	PS105	116, 117
MR36H	134	NA35	116, 117	OSS36503	116, 117	PD107	116, 117	PS110	116, 117
MR150C-H	145	NA36	116, 117	OSS36885	116, 117	PD107A	116, 117	PS120	116, 117
MR990	125	NA42	116, 117	OY101	116, 117	PD108	116, 117	PS125	116, 117
MR1032B	116, 117	NA45	116, 117	OY5061	116, 117	PD110	116, 117	PS130	116, 117
MR1237FB	116, 117	NA46	116, 117	OY5062	116, 117	PD111	116, 117	PS135	116, 117
MR1237FL	116, 117	NA62	117, 116	OY5063	116, 117	PD114	125	PS140	116, 117
MR1237SB	116, 117	NA63	117, 116	OY5064	116, 117	PD115	125	PS150	116, 117
MR1237SL	116, 117	NA65	117, 116	OY5065	116, 117	PD116	125	PS160	116, 117
MR1247FB	116, 117	NA66	117, 116	OY5066	117, 116	PD122	116, 117	PS405	116, 117
MR1247FL	116, 117	NA74	125	OY5067	116, 117	PD125	116, 117	PS410	116, 117
MR1247SB	116, 117	NA75	125	P1A5	116, 117	PD129	116, 117	PS415	116, 117
MR1247SL	116, 117	NA76	125	P1B5	116, 117	PD130	116, 117	PS420	116, 117
MR1267	116, 117	NA84	125	P2A5	116, 117	PD131	116, 117	PS425	116, 117
MR1337-1	116, 117	NA85	125	P2B5	116, 117	PD132	116, 117	PS430	116, 117
MR1337-2	116, 117	NA86	125	P3A5	116, 117	PD133	116, 117	PS435	116, 117
MR1337-3	116, 117	NA104	125	P3/2H	116, 117	PD134	116, 117	PS440	116, 117
MR1337-4	116, 117	NA105	125	P4A5	116, 117	PD135	116, 117	PS450	116, 117
MR1337-5	116, 117	NGP3002	109	P5A5	116, 117	PD0910	116, 117	PS460	117, 116
MR2261	116, 117	NGP3003	116, 117	P6A5	116, 117	PD0913	125	PS603	116, 117
MR2266	125	NGP5002	137	P6/2H	116, 117	PD0914	125	PS604	116, 117
MR2272	116	NGP5007	139	P6RP8	125	PD0915	125	PS605	116, 117
MR2273	116, 117	NGP5010	142	P6RP10	125	PD0916	125	PS609	116, 117
MS1H	116, 117	NL10	116, 117	P7A5	116, 117	PD0603	134	PS610	116, 117
MS2H	116, 117	NL11	116, 117	P8/2H	116, 117	PD06003A	134	PS611	116, 117
MS3H	116, 117	NL15	116, 117	P15	113	PD06007	135	PS615	116, 117
MS4H	116, 117	NL20	116, 117	P16	114	PD06007A	135	PS616	116, 117
MS5H	116, 117	NL25	116, 117	P17	115	PD06008	136	PS617	116, 117
MS11H	116, 117	NL30	116, 117	P100	116, 117	PD06008A	136	PS621	116, 117
MS12H	116, 117	NL40	116, 117	P200	116, 117	PD06009	137	PS622	116, 117
MS13H	116, 117	NL50	116, 117	P400	116, 117	PD06009A	137	PS623	116, 117
MS14H	116, 117	NL60	117, 116	P580	116, 117	PD06014	140	PS627	116, 117
MS35H	116, 117	NP50A	116, 117	P600	116, 117	PD06014A	140	PS628	116, 117
MS36H	116, 117	NP60A	117, 116	P800	125	PD06016	142	PS629	116, 117
MS50	116, 117	NPC0010	116, 117	P1000	125	PD06016A	142	PS632	116, 117
MT14	116, 117	NSS121	125	P10115	116, 117	PD06018	145	PS633	116, 117
MT24	116, 117	NU34	109	P10155	109	PD06018A	145	PS636	116, 117
MT44	116, 117	NU398B	116, 117	P10156	116, 117	PD06044	134	PS637	116, 117
MT64	116, 117	O101	116, 117	P21316	116, 117	PD06048	135	PS1140	125
MT84	125	OA6	109	P21317	116, 117	PD06049	136	PS1511	140
MZ5A	136	OA7	109	P21344	139	PD06055	140	PS1512	140
MZ5.1T5	135	OA9	109	PA069	116, 117	PD06059	145	PS1513	140
MZ6.2	137	OA70	109	PA070	116, 117	PE401	116, 117	PS1514	140
MZ6.2A	137	OA71	109	PA071	116, 117	PE401N	116, 117	PS1515	140
MZ6.2B	137	OA71C	109	PA3	116, 117	PE402	116, 117	PS1516	140
MZ6.2T5	137	OA72	109	PA200	116, 117	PE403	116, 117	PS1517	140
MZ10A	140	OA73	109	PA300	125	PE404	116, 117	PS2207	116, 117

DIODES and RECTIFIERS (cont'd)

Type To Be Replaced	Sylvania ECG Replacement	Type To Be Replaced	Sylvania ECG Replacement	Type To Be Replaced	Sylvania ECG Replacement	Type To Be Replaced	Sylvania ECG Replacement	Type To Be Replaced	Sylvania ECG Replacement
PS2208	116, 117	Q227T10	146	RFV60500	116, 117	S1D	125	S79	116, 117
PS2209	116, 117	R080	125	RL31	109	S1S M-150-02	116, 117	S81	116, 117
PS2247	116, 117	R1	116, 117	RL32	109	S1S W-05-02	116, 117	S82	116, 117
PS2249	116, 117	R1A	116, 117	RL32G	109	S1S20	109	S83	116, 117
PS2412	116, 117	R1B	116, 117	RL34	109	S2A06	116, 117	S84	116, 117
PS2413	116, 117	R3/H2	116, 117	RL34G	109	S2A10	116, 117	S85	116, 117
PS2415	116, 117	RA4	116, 117	RL41	109	S2AR1	116, 117	S86	116, 117
PS2416	125	R5	125	RL41G	109	S2AR2	116, 117	S91	116, 117
PS2417	125	R5B	125	RL42	109	S2C30	116, 117	S91-A	116, 117
PS4559	116, 117	R5C	125	RL52	109	S2C40	116, 117	S91-H	116, 117
PS4560	116, 117	R6	125	RL232G	109	S2C40A	116, 117	S92	116, 117
PS4725	116, 117	R6/ZH	116, 117	RL246	109	S2E20	116, 117	S92-A	116, 117
PS5300	116, 117	R8	125	RL252	109	S2E60	116, 117	S92-H	116, 117
PS5301	116, 117	R8/ZH	125	RLF1G	116, 117	S2E60-1	116, 117	S93	116, 117
PS5302	116, 117	R60-1007	109	RS220AF	116, 117	S2E100	125	S93A	116, 117
PS6325	150	R66-8504	116, 117	RS230AF	116, 117	S2PB	116, 117(4)	S93H	116, 117
PS6468	135	R122C	116, 117	RS1264	116, 117	S3A06	116, 117	S94	116, 117
PS8906	135	R154B	116, 117(4)	RS1290	137	S3AR1	116, 117	S95	116, 117
PS8907	136	R855-2	116, 117	RS1296	116, 117(4)	S3M X	116, 117	S100	125
PS8908	137	R105064	118	RS1805	116, 117	S4A06	116, 117	S101	116, 117
PS8915	142	R106379	116, 117	RS1811	109	S4AR1	116, 117	S102	116, 117
PS8917	145	R109328	113	RS1832	116, 117	S4AR2	116, 117	S103	116, 117
PS10019B	139	R109474	113	RS2801	109	S4AR30	116, 117	S104	116, 117
PS10022B	142	R113321	116, 117	RS3570	116, 117	S4FN300	116, 117	S105	116, 117
PS10024B	145	R113392	116, 117	RS3727	116, 117	S5AR1	116, 117	S106	116, 117
PS10063	139	RC080	125	RS6344	116, 117	S5AR2	116, 117	S107	116, 117
PS10066	142	RD5A	136	RS6461	116, 117	S6AR1	116, 117	S108	116, 117
PS10068	145	RD5B	136	RS6471	116, 117	S6AR2	116, 117	S115	116, 117
PT-3	116, 117	RD11A	141	RS6705	116, 117	S7AR1	125	S129	116, 117
PT-5	116, 117	RD13A	143	RT1008	109	S8AR1	125	S201	116, 117
PT-5B	116, 117	RD13B	143	RT1106	109	S8AR2	125	S202	116, 117
PT6D22/1	116, 117	RD13C	143	RT1108	109	S9AR1	125	S203	116, 117
PT9C22/1	116, 117(4)	RD13D	143	RT1184	109	S10	116, 117	S204	116, 117
PT-505	116, 117	RD250	116, 117	RT1867	109	S10A	116, 117	S205	116, 117
PT-510	116, 117	RD3472	116, 117	RT1689	109	S10AR1	125	S206	117, 116
PT-515	116, 117	RD26235-1	116, 117	RT1840	116, 117	S10AR2	125	S208	125
PT-520	116, 117	RD29799P	116, 117	RT2016	109	S13	116, 117	S210	125
PT-525	116, 117	RD31903P	116, 117	RT2334	109	S14	116, 117	S217	116, 117
PT-530	116, 117	RE2	116, 117	RT2451	110	S15	116, 117	S218	117, 116
PT-540	116, 117	RE3	116, 117	RT2452	109	S16	116, 117	S219	116, 117
PT-550	116, 117	RE504	117, 116	RT2669	116, 117(2)	S16A	116, 117	S220	116, 117
PT-560	116, 117	RERO23	113	RT2694	109	S16B	116, 117	S221	116, 117
PT580	125	RF1811	109	RT3072	109	S17	116, 117	S222	116, 117
PT72130	116, 117	RF3160	116, 117	RT3099	109	S17A	116, 117	S223	116, 117
PV-8	116, 117	RF3472	116, 117	RT3443	116, 117	S18	116, 117	S224	116, 117
Q1B	116, 117	RF5464-1P	113	RT3469	109	S18A	116, 117	S230	116, 117
Q14	116, 117	RF5465	113	RT3574	138	S18B	116, 117	S232	117, 116
Q3/2	116, 117	RF5465-1P	113	RT3671	145	S19	116, 117	S233	116, 117
Q4B	116, 117	RF5794	114	RT3858	116, 117	S19A	116, 117	S234	117, 116
Q6/2	116, 117	RF6235-1	116, 117	RT3981	116, 117	S20	125	S235	116, 117
Q8/2	116, 117	RF26234-1	116, 117	RT4050	116, 117	S20ND400	116, 117	S238	116, 117
Q49	109	RF26235-1	116, 117	RT4232	116, 117	S20NH400	116, 117	S239	116, 117
Q90	109	RF26235-5	116, 117	RT61012	109	S21	116, 117	S240	116, 117
Q51	109	RF29799P	116, 117	RV6-2	137	S22	116, 117	S241	116, 117
Q52	116, 117	RF31903P	116, 117	RZ3.6	134	S22A	116, 117	S243	116, 117
Q53	116, 117	RF32101R	116, 117	RZ5.1	135	S23	117, 116	S250	116, 117
Q54	116, 117	RF32101-8	116, 117	RZ5.6	136	S23A	116, 117	S251	116, 117
Q55	116, 117	RF32101-9	116, 117	RZ6.2	137	S24	125	S252	116, 117
Q56	116, 117	RF32102R	119	RZ10	140	S26	116, 117	S253	116, 117
Q57	116, 117	RF32103-1	118	RZ15	145	S28	125	S254	116, 117
Q58	116, 117	RF32103R	118	RZ15A	145	S30	116, 117	S255	116, 117
Q59	116, 117	RF32412-3	116, 117(3)	RZ27	146	S31	116, 117	S256	117, 116
Q60	116, 117	RF32645	116, 117	RZ27A	146	S32	116, 117	S257	125
QZ3.6T5	134	RF33426-7	113	RZ23A	147	S33	116, 117	S258	125
QZ3.6T10	134	RF33976	116, 117	RZ82A	150	S34	116, 117	S260	125
QZ5.1T5	135	RF34363	116, 117	RZ33.6	134	S35	116, 117	S262	116, 117
QZ5.1T10	135	RF361197	116, 117	RZ35.1	135	S36	116, 117	S428	116, 117
QZ5.6T5	136	RFJ30704	116, 117	RZ55.6	136	S40	116, 117	S431	116, 117
QZ5.6T10	136	RFJ31218	116, 117	RZ76.2	137	S40A	116, 117	S500	125
QZ6.2T5	137	RFJ31362	116, 117	RZ10	140	S44	116, 117	S500B	116, 117
QZ6.2T10	137	RFJ31363	116, 117	RZ21.5	145	S46	116, 117	S500C	116, 117
QZ10T5	140	RFJ33292	116, 117	S010G	125	S47	116, 117	S750	125
QZ10T10	140	RFJ60286	116, 117	S046	110	S48	116, 117	S750C	125
QZ12T5	142	RFJ60313	113	S1A-3	137	S49	116, 117	S855	120
QZ12T10	142	RFJ60366	116, 117	S1AR1	116, 117	S61	125	S913	118
QZ14T5	144	RFJ60614	109	S1AR2	116, 117	S62	125	S926	118
QZ14T10	144	RFJ60869	116, 117	S1A06	116, 117	S63	125	S1384	110
QZ15T5	145	RFL30596	116, 117	S1A060	116, 117	S73	116, 117	S6005	116, 117
QZ15T10	145	RFM33160	116, 117	S1B	116, 117	S75	116, 117	S10149	116, 117(4)
QZ27T5	146	RFP33118	116, 117	S1C	125	S77	116, 117	S17074	113

## DIODES and RECTIFIERS (cont'd)

Type To Be Replaced	Sylvania ECG Replacement	Type To Be Replaced	Sylvania ECG Replacement	Type To Be Replaced	Sylvania ECG Replacement	Type To Be Replaced	Sylvania ECG Replacement	Type To Be Replaced	Sylvania ECG Replacement
SB01	116, 117	SD-94	116, 117	S1600	116, 117	SLA536	116, 117	SM130	116, 117
SB-2	116, 117	SD-94A	116, 117	S1D2A-1	113	SLA537	116, 117	SM140	116, 117
SB302	116, 117	SD-94AB	116, 117	S1D2A-3	113	SLA538	116, 117	SM150-005	109
SB315	116, 117	SD94S	116, 117	S1D3B-3	115	SLA539	116, 117	SM150-02	116, 117
SB332	116, 117	SD-95	116, 117	S1D01E	116, 117	SLA540	116, 117	SM150-6	116, 117
SB333	116, 117	SD-95A	116, 117	S1D01K	125	SLA547	116, 117	SM150	116, 117
SB393	116, 117	SD96	116, 117	S1D01L	116, 117	SLA560	125	SM150A	116, 117
SC1	116, 117	SD96A	116, 117	S1D02E	116, 117	SLA561	125	SM150B	116, 117
SC2	116, 117	SD98A	125	S1D02K	125	SLA599	116, 117	SM150C	125
SC4	116, 117	SD98S	125	S1D02L	116, 117	SLA599A	116, 117	SM150D	125
SC-6	109	SD-101	116, 117	S1GL/100	116, 117	SLA600	116, 117	SM150S	116, 117
SC8	125	SD102	116, 117	S1GL/200	116, 117	SLA600A	116, 117	SM150SS	116, 117
SC8A	125	SD104	116, 117	S1GL/400	116, 117	SLA601	116, 117	SM160	116, 117
SC10	125	SD105	116, 117	S1GL/600	116, 117	SLA601A	116, 117	SM170	125
SC10A	125	SD165	116, 117	S1GL/800	125	SLA602	116, 117	SM180	125
SC20	109	SD-201	116, 117	S1L200	116, 117	SLA602A	116, 117	SM200	125
SC54	109	SD-404	111, 112	S1S-M-150-01	116, 117	SLA603	116, 117	SM205	116, 117
SC110	117, 116	SD900	116, 117	S1S-W-05-02	116, 117	SLA603A	116, 117	SM210	116, 117
SC305	116, 117	SD300C	116, 117	S1J051F	116, 117	SLA604	116, 117	SM220	116, 117
SC4116	116, 117	SD600	116, 117	S1J052F	116, 117	SLA604A	116, 117	SM230	116, 117
SCA05	116, 117	SD600C	116, 117	S1J60F	116, 117	SLA605	116, 117	SM240	116, 117
SCA1	116, 117	SD800	125	S1J101F	116, 117	SLA605A	116, 117	SM250	116, 117
SCA2	116, 117	SD910	125	S1J102F	116, 117	SLA606	116, 117	SM260	116, 117
SCA3	116, 117	SD910A	125	S1J201F	116, 117	SLA606A	116, 117	SM270	125
SCA4	116, 117	SD910S	125	S1J202F	116, 117	SLA1095	116, 117	SM280	125
SCA5	116, 117	SDD4	113	S1J301F	116, 117	SLA1096	117, 116	SM300	125
SCA6	116, 117	SDD5	114	S1J302F	116, 117	SLA1100	116, 117	SM483	116, 117
SCA8	125	SDD6	115	S1J401F	116, 117	SLA1101	116, 117	SM486	116, 117
SCA10	125	SE-05	116, 117	S1J402F	116, 117	SLA1102	116, 117	SM487	116, 117
SCE1	116, 117	SE05A	116, 117	S1J501F	116, 117	SLA1103	116, 117	SM488	116, 117
SCE2	116, 117	SE05B	116, 117	S1J601F	116, 117	SLA1104	116, 117	SM505	116, 117
SCE4	116, 117	SE05D	116, 117	SK3016	116, 117	SLA1105	117, 116	SM510	116, 117
SCE6	116, 117	SE05S	116, 117	SK3017	116, 117	SLA1487	116, 117	SM512	116, 117
SCE8	125	SE05SS	116, 117	SK3017A	116, 117	SLA1488	116, 117	SM513	116, 117
SCE10	125	SE46	116, 117	SK3030	116, 117	SLA1489	116, 117	SM514	116, 117
SC05	116, 117	SE1730	125	SK3031	116, 117	SLA1490	116, 117	SM515	116, 117
SC05E	116, 117	SE30B26A	116, 117	SK3032	125	SLA1491	116, 117	SM516	116, 117
SCR20C	122	SFD107	109	SK3035	125	SLA1492	117, 116	SM517	125
SD05	116, 117	SFD112	109	SL-2	116, 117	SLA1692	116, 117	SM518	125
SD07	116, 117	SFR135	116, 117	SL-3	116, 117	SLA1693	116, 117	SM520	125
SD1	116, 117	SFR151	116, 117	SL5	116, 117	SLA1694	116, 117	SM645	116, 117
SD-1A	116, 117	SFR152	116, 117	SL91	116, 117	SLA1695	116, 117	SM646	116, 117
SD-1B	125	SFR153	116, 117	SL92	116, 117	SLA1696	116, 117	SM705	116, 117
SD1C	125	SFR154	116, 117	SL93	116, 117	SLA1697	116, 117	SM710	116, 117
SD-1HF	116, 117	SFR155	116, 117	SL608	125	SLA2610	116, 117	SM720	116, 117
SD1L	116, 117	SFR156	116, 117	SL610	125	SLA2611	116, 117	SM730	116, 117
SD-1LA	116, 117	SFR164	116, 117	SL708	125	SLA2612	116, 117	SM740	116, 117
SD-1X	116, 117	SFR251	116, 117	SL710	125	SLA2613	116, 117	SM750	116, 117
SD-1Y	116, 117	SFR252	116, 117	SL-833	116, 117	SLA2614	116, 117	SM760	116, 117
SD-1Z	125	SFR253	116, 117	SL-833A	116, 117	SLA2615	116, 117	SM770	125
SD2	116, 117	SFR254	116, 117	SLA11AB	116, 117	SLA2616	125	SM780	125
SD2A	116, 117	SFR255	116, 117	SLA11C	116, 117	SLA2617	125	SM800	125
SD2B	125	SFR256	116, 117	SLA12AB	116, 117	SLA3193	116, 117	SO10G	125
SD2C	125	SFR258	125	SLA12C	116, 117	SLA3194	116, 117	SP-1	116, 117
SD4	116, 117	SFR264	116, 117	SLA13AB	116, 117	SLA3195	116, 117	SPN-01	116, 117
SD6	116, 117	SFR266	116, 117	SLA13C	116, 117	SLA3196	125	SQ46	109
SD7	125	SFR268	125	SLA14AB	116, 117	SLA01	125	SR-0004	113
SD8	125	SFZ708	136	SLA14C	116, 117	SM4	116, 117	SR-1	116, 117
SD12	116, 117	SFZ716	142	SLA15AB	116, 117	SM5	116, 117	SRIDMX	116, 117
SD12B	109	SFZ-005	116, 117	SLA15C	116, 117	SM10	116, 117	SRIEM2	116, 117
SD12E	109	SG105	116, 117	SLA16AB	116, 117	SM11	116, 117	SR1T	116, 117
SD12M	109	SG-205	116, 117	SLA16C	116, 117	SM20	116, 117	SR1Z	116, 117
SD14	109	SG-305	116, 117	SLA17AB	116, 117	SM30	116, 117	SR2A-1	116, 117
SD15	109	SG323	116, 117	SLA17C	116, 117	SM31	116, 117	SR2A-2	116, 117
SD21A	109	SG505	116, 117	SLA18AB	125	SM40	116, 117	SR2A-4	116, 117
SD-46	109	SG-805	116, 117	SLA18C	125	SM50	116, 117	SR2A-8	116, 117
SD-51	112	SG-1198	116, 117	SLA19AB	125	SM51	116, 117	SR2A-12	117, 116
SD56	109	SG-3400	116, 117	SLA19C	125	SM60	116, 117	SR3	116, 117
SD-80	116, 117	SH1	116, 117	SLA440	116, 117	SM70	125	SR5	116, 117
SD-82	111, 112	SH1A	116, 117	SLA440B	116, 117	SM71	125	SR6	113
SD82A	112	SH1B	125	SLA441	116, 117	SM73	125	SR10	114
SD82AG	112	SH1C	125	SLA441B	116, 117	SM80	125	SR13	113
SD-91	116, 117	SH4D05	116, 117	SLA442	116, 117	SM81	125	SR14	114
SD-91A	116, 117	SH4D1	116, 117	SLA442B	116, 117	SM83	125	SR15	114
SD91S	116, 117	SH4D2	116, 117	SLA443	116, 117	SM100	125	SR17	116, 117
SD-92	116, 117	SH4D3	116, 117	SLA444	116, 117	SM101	125	SR20	116, 117
SD-92A	117, 116	SH4D4	116, 117	SLA444A	116, 117	SM103	125	SR21	113
SD92S	116, 117	SH4D6	116, 117	SLA444B	116, 117	SM105	125	SR22	116, 117
SD-93	116, 117	SH4D8	125	SLA445	116, 117	SM110	116, 117	SR23	116, 117
SD-93A	116, 117	S191G	116, 117	SLA445B	116, 117	SM120	116, 117	SR24	116, 117

DIODES and RECTIFIERS (cont'd)

Type To Be Replaced	Sylvania ECC Replacement	Type To Be Replaced	Sylvania ECC Replacement	Type To Be Replaced	Sylvania ECC Replacement	Type To Be Replaced	Sylvania ECC Replacement	Type To Be Replaced	Sylvania ECC Replacement
SR27	116, 117	ST18	125	T1G	109	TE1078	116, 117	TK600	116, 117
SR28	116, 117	ST47	111, 112	T2G	109	TE1078A	116, 117	TK800	125
SR29	113	ST2040P	116, 117	T3/2	116, 117	TE1080	116, 117	TK1000	125
SR30	116, 117	SV122	135	T3G	109	TE1086	113	TKF5	116, 117
SR31	119	SV133	140	T7	109	TE1095	118	TKF10	116, 117
SR32	118	SV135	142	T8/2	116, 117	TF20	116, 117	TKF20	116, 117
SR37	120	SV137	144	T8G	109	TF21	116, 117	TKF40	116, 117
SR40	116, 117	SV138	145	T9	109	TF22	116, 117	TKF60	116, 117
SR50	116, 117	SV1017	142	T9G	109	TF23	116, 117	TKF80	125
SR60	116, 117	SV1019	144	T11	109	TFR120	116, 117	TKF100	125
SR76	116, 117	SV1020	145	T12	109	TG11	116, 117	TL1	116, 117
SR100	116, 117	SV1238E	116, 117	T12G	109	TG12	116, 117	TL2	116, 117
SR101-1	116, 117	SV4012	142	T13	109	TG21	116, 117	TL11	116, 117
SR101-2	116, 117	SV4012A	142	T13G	109	TG22	116, 117	TL12	116, 117
SR105	116, 117	SV4014	144	T14	109	TG31	116, 117	TL21	116, 117
SR112	116, 117	SV4014A	144	T14G	109	TG32	116, 117	TL22	116, 117
SR114	116, 117	SV4015	145	T17	109	TG41	116, 117	TL31	116, 117
SR120	116, 117	SV4015A	145	T18	109	TG42	116, 117	TL32	116, 117
SR131-1	116, 117	SV4027	146	T20	109	TG51	116, 117	TL41	116, 117
SR144	116, 117	SV4027A	146	T20G	109	TG52	116, 117	TL42	116, 117
SR145	116, 117	SV4033	147	T21	109	TG61	116, 117	TL51	116, 117
SR150	125	SV4033A	147	T21G	109	TG62	116, 117	TL61	116, 117
SR151	116, 117	SV4055	148	T22	109	TH1S557	116, 117	TM33	116, 117
SR152	116, 117	SV4055A	148	T22G	109	TH400	116, 117	TM43	116, 117
SR200	116, 117	SV4062	149	T23G	109	TH600	116, 117	TM62	116, 117
SR200B	116, 117	SV4062A	149	T24G	109	TH800	125	TM63	116, 117
SR205	116, 117	SV4082	150	T26G	109	TH801	116, 117	TM65	116, 117
SR401	116, 117	SV4082A	150	T27G	109	TH802	116, 117	TM66	116, 117
SR405	116, 117	SV12388	116, 117	T50	116, 117	TH803	116, 117	TM86	125
SR499	116, 117	SV12388E	116, 117	T100	116, 117	TH804	116, 117	TMD01	135
SR900	116, 117	SVC625	137	T140A0	122	TH805	116, 117	TMD01A	135
SR900B	116, 117	SVC1125	137	T140A1	122	TH806	116, 117	TMD02	136
SR905	116, 117	SV21150	141	T140A2	122	TH808	125	TMD02A	136
SR846-2	116, 117	SVM61	131	T200	116, 117	TH810	125	TMD03	137
SR889	116, 117	SVM111	141	T300	116, 117	TH1000	125	TMD03A	137
SR1493	116, 117	SVM601	137	T400	116, 117	THSG105	116, 117	TMD08	140
SR1668	116, 117	SVM602	137	T450	116, 117	TI52	116, 117	TMD08A	140
SR1692	116, 117	SVM605	137	T500	116, 117	TI53	116, 117	TMD41	116, 117
SR1693	116, 117	SVM1105	141	T550	116, 117	TI54	116, 117	TMD42	116, 117
SR1694	116, 117	SVM11020	141	T600	116, 117	TI-55	116, 117	TMD45	116, 117
SR1695	116, 117	SVM11021	141	T650	116, 117	TI56	116, 117	TP34	109
SR1731-1	116, 117	SW05-01	116, 117	T800	125	TI57	116, 117	TP34A	109
SR1731-2	116, 117	SW-05-02	116, 117	T800X	125	TI58	116, 117	TP101	116, 117
SR1731-3	116, 117	SW05	116, 117	T1000	125	TI59	116, 117	TP201	116, 117
SR1731-4	116, 117	SW05A	116, 117	T1000X	125	TI60	116, 117	TP302	116, 117
SR1731-5	116, 117	SW05B	116, 117	T10144	116, 117	TIRO1	116, 117	TP402	116, 117
SR1742	116, 117	SW05C	125	T10453	116, 117	TIRO2	116, 117	TR2880	116, 117
SR1766	116, 117	SW05D	125	T21237	109	TIRO3	116, 117	TR320007	110
SR1984	116, 117	SW05S	116, 117	T21238	109	TIRO4	116, 117	TR320008	109
SR2121	116, 117	SW05SS	116, 117	T21312	116, 117	TIRO5	116, 117	TR320020	116, 117
SR2301A	116, 117	SW05V	116, 117	T21313	109	TIRO6	116, 117	TR320022	116, 117
SR3010	116, 117	SW1	116, 117	T21333	116, 117	TIRO7	116, 117	TR320039	109
SR3582	116, 117	SWC	125	T21334	139	TIRO8	116, 117	TR320041	109
SR3943	116, 117	SWD	125	T4590	116, 117	TIRO9	116, 117	TR320048	109
SR6134	116, 117	SX623	116, 117	TA50	116, 117	TIRO10	125	TR330027	116, 117
SR6324	116, 117	SX631	116, 117	TA100	116, 117	TIUG1888	110	TR330028	101
SR6325	116, 117	SX633	116, 117	TA200	116, 117	TIXD747	134	TRC-P4	113
SR6415	116, 117	SX641	116, 117	TA300	116, 117	TIXD753	137	TRR6	137
SR6560	116, 117	SX642	116, 117	TA400	116, 117	TIXD758	140	TS05	116, 117
SR6567	116, 117	SX643	116, 117	TA500	116, 117	TJ5A	116, 117	TS1	116, 117
SR6617	116, 117	SX644	116, 117	TA600	116, 117	TJ10A	116, 117	TS2	116, 117
SRIA-1	116, 117	SX645	116, 117	TA800	125	TJ15A	116, 117	TS2A	116, 117
SRIA-2	116, 117	SYL128	110	TA1000	125	TJ20A	116, 117	TS4	116, 117
SRIA-4	116, 117	SZ5	135	TA1062	116, 117	TJ25A	116, 117	TS6	116, 117
SRIA-8	116, 117	SZ5.1	135	TA1063	116, 117	TJ30A	116, 117	TS8	125
SRIA-12	117, 116	SZ5.6	135	TA1064	116, 117	TJ35A	116, 117	TSB245	116, 117
SR9000	118	SZ5.2	137	TC02P12	116, 117	TJ40A	116, 117	TT56X26	116, 117
SR9001	119	SZ5.2A	137	TC0.09M21/3	116, 114	TJ50A	116, 117	TV4	116, 117
SR9002	118	SZ9	139	TC0.2P11/2	116, 117	TK5	116, 117	TV6.5	116, 117
SR9003	116(3)	SZ10	140	TC27A5A	146	TK10	116, 117	TV8	125
SS321	116, 117	SZ12	142	TC33A5A	147	TK11	116, 117	TV2496	116, 117
SS322	116, 117	SZ12.0	142	TC62A5B	149	TK20	116, 117	TV24103	112
SS324	116, 117	SZ14	144	TC82A5B	150	TK21	116, 117	TV24104	116, 117
SS334	116, 117	SZ15	145	TC110A5B	351	TK30	116, 117	TV24125	116, 117
SS337	116, 117	SZ15.0	145	TC136	116, 117	TK40	116, 117	TV24136	116, 117
SS455	116, 117	SZ200	135	TE1011	116, 117	TK41	116, 117	TV24155	116, 117
ST2B	116, 117(4)	SZ1200	148	TE1024C	116, 117	TK50	116, 117	TV24159	112
ST12	116, 117	T-065	116, 117	TE1029	116, 117	TK60	116, 117	TV24169	116, 117
ST14	116, 117	T-075	116, 117	TE1042	116, 117	TK61	116, 117	TV24182	111, 112
ST16	116, 117	T-0150	116, 117	TE1050	116, 117	TK400	116, 117	TV24190	113

## DIODES and RECTIFIERS (cont'd)

Type To Be Replaced	Sylvania ECG Replacement	Type To Be Replaced	Sylvania ECG Replacement	Type To Be Replaced	Sylvania ECG Replacement	Type To Be Replaced	Sylvania ECG Replacement	Type To Be Replaced	Sylvania ECG Replacement
TV24191	116, 117	TZ110	151	VBH600	116, 117	XS-17	116, 117	ZA33	147
TV24193	116, 117	TZ110A	151	VD11	109	XS17A	116, 117	ZA33A	147
TV24200	116, 117	TZ105B	151	VD12	109	XS18	116, 117	ZA33B	147
TV24224	116, 117	TZ110C	151	VD13	109	XS22	116, 117	ZA62	149
TV24226	113	UJS102	116, 117	VFA2745C	116, 117	XS23	116, 117	ZA62A	149
TV24232	116, 117	U212	116, 117	VM009M	113	XS23A	116, 117	ZA62B	149
TV24234	116, 117	U212-25	116, 117	VM-PH9D522/1	116, 117	XS-31	116, 117	ZA82	150
TV24237	120	U213	116, 117	VMMPH11D522/1	116, 117	XU604	116, 117	ZA82A	150
TVC-6	120	U214	116, 117	VM-TC02P11/2	116, 117	Y00	114	ZA82B	150
TVM-EH2C11	116(3)	U633	116, 117	VR10	140	YCO2P11/2	116, 117	ZA110	151
TVM-K112C	113	U2400-03	116, 117	VR12	142	YSG-V47-1-3	116, 117	ZA110A	151
TVM-M204B	116, 117	U13033801	116, 117	VR12A	142	Z1B5-1	135	ZA110B	151
TVM-PH9D22/11	116, 117(4)	UR105	116, 117	VR12B	142	Z1B5.6	136	ZB1-11	141
TVM-PT6D22/1	116, 117	UR110	116, 117	VR33	147	Z1B6.2	137	ZB5.1	135
TVM-TC02P11/2	116, 117	UR115	116, 117	VR33A	147	Z1B7.5	138	ZB5.6	136
TVM-TK705M	113	UR120	116, 117	VR33B	147	Z1B10	140	ZB5.6A	136
TVS-0A70	109	UR125	116, 117	VR110	151	Z1B12	142	ZB5.6B	136
TVS-0A90	109	UT11	116, 117	VR110A	151	Z1B15	145	ZB6.2	137
TVS-0A91	109	UT12	116, 117	VR110B	151	Z1D6.2	137	ZB6.2A	137
TVS-10D8	125	UT13	116, 117	V50A70	109	Z1D7.5	138	ZB6.2B	137
TVS-182G	112	UT14	116, 117	VS-1	116, 117	Z1D15	145	ZB10	140
TVS-DG1NR	116, 117	UT15	116, 117	VS120	116, 117	Z2A51F	135	ZB10X	140
TVS-DS-1K	116, 117	UT16	116, 117	V5202	116, 117	Z2A56F	136	ZB12	142
TVS-DS1M	116, 117	UT17	116, 117	VS-DG1NR	116, 117	Z2A62F	137	ZB12A	142
TVS-FR-1P	116, 117	UT18	116, 117	VSG-2002A	116, 117	Z2A91F	139	ZB12B	142
TVS-FR2P	116, 117	UT21	116, 117	VS-FR1	116, 117	Z2A120F	142	ZB15	145
TVS-FR10	125	UT22	116, 117	VS-FR1P	116, 117	Z2A150F	145	ZB15A	145
TVS-FT1N	116, 117	UT23	116, 117	VS-FT-1N	116, 117	Z3.6	134	ZB15B	145
TVS-K112C	113	UT24	116, 117	VSPH9D522/1	116, 117	Z4B5.1	135	ZB27	146
TVS-PC02P11/2	116, 117	UT25	116, 117	VS-SD-1B	125	Z4B5.6	136	ZB27A	146
TVS-PC02P11/2	116, 117	UT26	116, 117	VS-SD-1Z	116, 117	Z4B9.1	139	ZB27B	146
TVS-RD7A	138	UT27	116, 117	VS-SD-82A	111, 112	Z4B12	142	ZB33	147
TVS-S82	112	UT111	116, 117	VS-TCO-2P11/2	116, 117	Z4B15	145	ZB33A	147
TVS-SD1A	116, 117	UT112	116, 117	WC14020	116, 117	Z4B27	146	ZB33B	147
TVS-SD-1B	125	UT113	116, 117	WC14027	116, 117	Z4B33	147	ZB62	149
TVS-TC0.09M21/3	114	UT114	116, 117	WC19865	116, 117	Z4X5.1A	135	ZB62A	149
TVS-ZB1-11	141	UT115	116, 117	WD001	116, 117	Z4X5.1B	135	ZB62B	149
TW3	116, 117	UT116	116, 117	WD002	116, 117	Z4XL6.2	137	ZB82	150
TW5	116, 117	UT117	116, 117	WD003	116, 117	Z4XL6.2B	137	ZB82A	150
TW10	116, 117	UT118	116, 117	WD004	116, 117	Z4XL7.5	138	ZB82B	150
TW20	116, 117	UT119	125	WD005	116, 117	Z4XL9.1	139	ZC012	142
TW30	116, 117	UT120	125	WD006	116, 117	Z4XL9.1B	139	ZC015	145
TW40	116, 117	UT121	116, 117	WD007	116, 117	Z4XL12	142	ZC027	146
TW50	116, 117	UT122	116, 117	WD008	116, 117	Z4XL12B	142	ZC033	147
TW60	116, 117	UT123	116, 117	WD009	116, 117	Z5B3.6	134	ZD012	142
TW80	125	UT214	116, 117	WD010	116, 117	Z5B5.1	135	ZD015	145
TW100	125	UT215	116, 117	WD011	116, 117	Z5B5.6	136	ZD027	146
TWV	116, 117	UT226	116, 117	WD012	116, 117	Z5B9.1	139	ZD033	147
TX1N645	116, 117	UT227	116, 117	WD013	116, 117	Z5B10	140	ZD5.1A	135
TX1N647	116, 117	UT228	116, 117	WD014	116, 117	Z5B12	142	ZD5.1B	135
TX1N3190	116, 117	UT229	116, 117	WD015	116, 117	Z5B15	145	ZD5.6A	136
TX1N3191	116, 117	UT231	116, 117	WR006	116, 117	Z5.6	136	ZD5.6B	136
TZ9.1	139	UT232	116, 117	WR011	116, 117	Z6.2	137	ZD6.2A	137
TZ9.1A	139	UT233	116, 117	WR030	116, 117(4)	Z10	140	ZD6.2B	137
TZ9.1B	139	UT234	116, 117	WR040	116, 117(4)	Z10K	140	ZD9.1	139
TZ9.1C	139	UT235	116, 117	WR100	116, 117	Z12K	142	ZD9.1A	139
TZ12	142	UT236	116, 117	WR200	116, 117	Z15	145	ZD9.1B	139
TZ12A	142	UT237	116, 117	WR300	116, 117	Z15K	145	ZD12	142
TZ12B	142	UT238	116, 117	WR400	116, 117	Z33	147	ZD12A	142
TZ12C	142	UT347	125	WRE981	116, 117	Z1010	139	ZD12B	142
TZ15	145	UT361	125	WT16X7	113	Z1012	140	ZD15	145
TZ15A	145	UZ3.6	134	WT16X8	115	Z1014	142	ZD15A	145
TZ15B	145	UZ5.1	135	WT16X9	114	Z1022	146	ZD15B	145
TZ15C	145	UZ6.2	137	WX6	109	Z1108	139	ZD27	146
TZ27	146	UZ7.5	138	WZ535	142	Z1112	142	ZD27A	146
TZ27A	146	UZ9.1	139	WZ537	144	Z1112C	142	ZD27B	146
TZ27B	146	UZ15	145	WZ538	145	Z1120	146	ZD33	147
TZ27C	146	V01G	125	WZ905	135	ZA9.1	139	ZD33A	147
TZ33	147	V210C	116, 117	WZ916	141	ZA9.1A	139	ZD33B	147
TZ33A	147	V270-D1	116, 117	WZ917	142	ZA9.1B	139	ZD62	149
TZ33B	147	V442	116, 117	WZ919	144	Z2	142	ZD62A	149
TZ33C	147	V8634-3	112	WZ920	145	ZA12A	142	ZD62B	149
TZ62	149	V10158	116, 117	XA121	116, 117	ZA12B	145	ZD82	150
TZ62A	149	V10916-3	109	XO2A	110	ZA13	144	ZD82A	150
TZ62B	149	VB100	116, 117	X5M6	116, 117	ZA15	145	ZD110	151
TZ62C	149	VB300	116, 117	X16	109	ZA15A	145	ZD110A	151
TZ82	150	VB400	116, 117	X18	109	ZA15B	145	ZD110B	151
TZ82A	150	VB500	116, 117	XS-10	116, 117	ZA27	146	ZE5.6	136
TZ82B	150	VB600	116, 117	XS16	116, 117	ZA27A	146	ZE10	140
TZ82C	150	VB600A	116, 117	XS16A	116, 117	ZA27B	146	ZE12	142

DIODES and RECTIFIERS (cont'd)

Type To Be Replaced	Sylvania ECC Replacement	Type To Be Replaced	Sylvania ECC Replacement	Type To Be Replaced	Sylvania ECC Replacement	Type To Be Replaced	Sylvania ECC Replacement	Type To Be Replaced	Sylvania ECC Replacement
ZE12A	142	ZH62A	149	ZP33A	147	ZS32	116, 117	ZU27A	146
ZE12B	142	ZH62B	149	ZP33B	147	ZS32A	116, 117	ZU27B	146
ZE15	145	ZH82	150	ZP62	149	ZS32B	116, 117	ZU33	147
ZE15A	145	ZH82A	150	ZP62A	149	ZS33	147	ZU33A	147
ZE15B	145	ZH82B	150	ZP62B	149	ZS33A	147	ZU33B	147
ZE27	146	ZH110	151	ZP82	150	ZS33B	147	ZU62	149
ZE27A	146	ZH110A	151	ZP82A	150	ZS34	116, 117	ZU62A	149
ZE27B	146	ZH110B	151	ZP82B	150	ZS34A	116, 117	ZU62B	149
ZE33	147	ZJ12	142	ZP110	151	ZS34B	116, 117	ZU82	150
ZE33A	147	ZJ12A	142	ZP110A	151	ZS50	116, 117	ZU82A	150
ZE33B	147	ZJ12B	142	ZP110B	151	ZS51	116, 117	ZU82B	150
ZE62	149	ZJ15	145	ZQ9.1	139	ZS52	116, 117	ZU110	151
ZE62A	149	ZJ15A	145	ZQ9.1A	139	ZS53	116, 117	ZU110A	151
ZE62B	149	ZJ15B	145	ZQ9.1B	139	ZS62	149	ZU110B	151
ZE82	150	ZJ27	146	ZQ12	142	ZS62A	149	ZV9.1	139
ZE82A	150	ZJ27A	146	ZQ12A	142	ZS62B	149	ZV9.1A	139
ZE82B	150	ZJ27B	146	ZQ12B	142	ZS70	116, 117	ZV9.1B	139
ZE110	151	ZJ33	147	ZQ15	145	ZS71	116, 117	ZV12	142
ZE110A	151	ZJ33A	147	ZQ15A	145	ZS72	116, 117	ZV12A	142
ZE110B	151	ZJ33B	147	ZQ15B	145	ZS73	116, 117	ZV12B	142
ZEC5.6	136	ZJ62	149	ZQ27	146	ZS74	116, 117	ZV15	145
ZEC12	142	ZJ62A	149	ZQ27A	146	ZS74B	116, 117	ZV15A	145
ZEC27	146	ZJ62B	149	ZQ27B	146	ZS76	116, 117	ZV15B	145
ZF3.6	134	ZJ82	150	ZQ33	147	ZS78	125	ZV27	146
ZF5.1	135	ZJ82A	150	ZQ33A	147	ZS78A	125	ZV27A	146
ZF5.6	136	ZJ82B	150	ZQ33B	147	ZS78B	125	ZV27B	146
ZF6.2	137	ZJ110	151	ZQ62	149	ZS82	150	ZV33	147
ZF10	140	ZJ110A	151	ZQ62A	149	ZS82A	150	ZV33A	147
ZF12	142	ZJ110B	151	ZQ62B	149	ZS82B	150	ZV33B	147
ZF12A	142	ZJ252B	116, 117	ZQ82	150	ZS90	116, 117	ZV62	149
ZF12B	142	ZM33	147	ZQ82A	150	ZS91	116, 117	ZV62A	149
ZF15	145	ZO-12	142	ZQ82B	150	ZS92	116, 117	ZV62B	149
ZF15A	145	ZO-12A	142	ZQ110	151	ZS94	116, 117	ZV82	150
ZF15B	145	ZO-12B	142	ZQ110A	151	ZS100	116, 117	ZV82A	150
ZF27	146	ZO-15	145	ZQ110B	151	ZS101	116, 117	ZV82B	150
ZF27A	146	ZO-15A	145	ZR15	116, 117	ZS102	116, 117	ZV110	151
ZF27B	146	ZO-15B	145	ZR60	116, 117	ZS103	116, 117	ZV110A	151
ZF33	147	ZO-27	146	ZR61	116, 117	ZS104	116, 117	ZV110B	151
ZF33A	147	ZO-27A	146	ZR62	116, 117	ZS108	116, 117	ZW2	116, 117
ZF33B	147	ZO-27B	146	ZR63	116, 117	ZS110	151	ZY12	142
ZF62	149	ZO-33	147	ZR64	116, 117	ZS110A	151	ZY12A	142
ZF62A	149	ZO-33A	147	ZR66	116, 117	ZS110B	151	ZY12B	142
ZF62B	149	ZO-33B	147	ZR500	116, 117	ZS120	116, 117	ZY15	145
ZF82	150	ZO-62	149	ZR590A	116, 117	ZT5.6	136	ZY15A	145
ZF82A	150	ZO-62A	149	ZR1025	116, 117	ZT5.6A	136	ZY15B	145
ZF82B	150	ZO-62B	149	ZR1031	116, 117	ZT5.6B	136	ZY27	146
ZG5.6	136	ZO-82	150	ZR1035	116, 117	ZT6.2	137	ZY27A	146
ZG10	140	ZO-82A	150	ZR1076	116, 117	ZT6.2A	137	ZY27B	146
ZG12	142	ZO-82B	150	ZS5.6	136	ZT6.2B	137	ZY33	147
ZG15	145	ZO-110	151	ZS5.6A	136	ZT9.1	139	ZY33A	147
ZG15A	145	ZO-110A	151	ZS5.6B	136	ZT9.1A	139	ZY33B	147
ZG15B	145	ZO-110B	151	ZS7	116, 117	ZT9.1B	139	ZY62	149
ZG27	146	ZOB3.6	134	ZS8	116, 117	ZT12	142	ZY62A	149
ZG27A	146	ZOB5.1	135	ZS9.1	139	ZT12A	142	ZY62B	149
ZG27B	146	ZOB5.6	136	ZS9.1A	139	ZT12B	142	ZY82	150
ZG33	147	ZOB6.2	137	ZS9.1B	139	ZT15	145	ZY82A	150
ZG33A	147	ZOB12	142	ZS10A	116, 117	ZT15A	145	ZY82B	150
ZG33B	147	ZOB15	145	ZS10B	116, 117	ZT15B	145	ZY110	151
ZG62	149	ZOB27	146	ZS12	142	ZT27	146	ZY110A	151
ZG62A	149	ZOB33	147	ZS12A	142	ZT27A	146	ZY110B	151
ZG62B	149	ZOB62	149	ZS12B	142	ZT27B	146	ZZ3.6	134
ZG82	150	ZOB82	150	ZS15	145	ZT33	147	ZZ5.6	136
ZG82A	150	ZOB110	151	ZS15A	145	ZT33A	147	ZZ6.2	137
ZG82B	150	ZOB6.2	137	ZS15B	145	ZT33B	147	ZZ10	140
ZH9.1	139	ZOD15	145	ZS20A	116, 117	ZT62	149	ZZ12	142
ZH9.1A	139	ZOD27	146	ZS20B	116, 117	ZT62A	149	ZZ15	145
ZH9.1B	139	ZOD33	147	ZS21	116, 117	ZT62B	149	ZZ27	146
ZH12	142	ZOD62	149	ZS22	116, 117	ZT82	150	ZZ33	147
ZH12A	142	ZOD82	150	ZS23	116, 117	ZT82A	150	ZZ62	149
ZH12B	142	ZOD110	151	ZS24	116, 117	ZT82B	150	ZZ82	150
ZH15	145	ZP12	142	ZS25	116, 117	ZT110	151	ZZ110	151
ZH15A	145	ZP12A	142	ZS27	146	ZT110A	151		
ZH15B	145	ZP12B	142	ZS27A	146	ZT110B	151		
ZH27	146	ZP15	145	ZS27B	146	ZU12	142		
ZH27A	146	ZP15A	145	ZS30	116, 117	ZU12A	142		
ZH27B	146	ZP15B	145	ZS30A	116, 117	ZU12B	142		
ZH33	147	ZP27	146	ZS30B	116, 117	ZU15	145		
ZH33A	147	ZP27A	146	ZS31	116, 117	ZU15A	145		
ZH33B	147	ZP27B	146	ZS31A	116, 117	ZU15B	145		
ZH62	149	ZP33	147	ZS31B	116, 117	ZU27	146		

# QUARTZ COLOR OSCILLATOR CRYSTALS

replacement guide by set manufacturer

Type to Be Replaced	ECG Replacement	Type to be Replaced	ECG Replacement	Type to be Replaced	ECG Replacement
<b>ADMIRAL</b>		<b>DU MONT</b>		<b>PILOT</b>	
93B3-3	358	105330	358	817147	358
93B3-4	358	R 105330	358	<b>RCA</b>	
93B22-3	358	817129	358	78896	358
93C22-1	358	817147	358	100449	358
93C22-3	358	<b>ELECTRHOME</b>		102249	358
<b>AIRLINE</b>		37-8-01	358	105330	358
TV24176	358	105330	358	1107863-1	358
QC-1	358	<b>EMERSON</b>		1107863-2	358
136-000100	358	R 105330	358	1107863-3	358
105330	358	817036	358	<b>RAYTHEON</b>	
530089-2	358	817129	358	8M-26102	358
<b>AMBASSADOR</b>		817147	358	<b>SETCHELL-CARLSON</b>	
R105330	358	817175	358	3.58MC	358
817129	358	<b>GENERAL ELECTRIC</b>		X-1018	358
817147	358	GE-41	358A	<b>SENTINEL</b>	
817157	358	GE-42	358	3.5MC Crystal	358
<b>AMC</b>		E T41X27	358A	20E1114	358
66X0003-001	358	E T41X47	358A	<b>SHARP</b>	
68X0003-001	358	23B-210067-001	358A	6I5130	358
105330	358	23B-210067-002	358A	<b>(SEARS) SILVERTONE</b>	
817147	358	<b>HOFFMAN</b>		T-E0317	358
<b>ANDREA</b>		3.58MC Crystal	358	33-4-3	358
3.5MC Crystal	358	136-000100	358	33-4-3A	358
A95-5286	358	136-000200	358	33-7-3	358
<b>ARISTOCRAT</b>		136-000300	358	48-77	358
3.5MC Crystal	358	<b>MAGNAVOX</b>		3374-3	358
2001786-169	358	M100449	358	105330	358
<b>BRADFORD</b>		M105330	358	599995	358
66X0003-001	358	530089-2	358	<b>STROMBERG CARLSON</b>	
68X0003	358	530128-1	358	162201	358
68X0003-001	358	<b>MOTOROLA</b>		<b>SYLVANIA</b>	
105330	358	48B7322230	358	72059	358
T-E0137	358	48T66544A88	358	105330	358
<b>CAPEHART</b>		48C66865A01	358	26-16162-1	358
750746A	358	48C66865A02	358B	<b>SYMPHONIC</b>	
<b>CATALINA</b>		48C66865A03	358B	T-E0317	358
66X0003-001	358	48C66865A04	358B	<b>TOSHIBA</b>	
105330	358	<b>MUNTZ</b>		599995	358
817147	358	CX9000	358	<b>TRUE-TONE</b>	
<b>CLAIRTONE</b>		<b>OLYMPIC</b>		8M-26102	358
80000900	358	CR32077R	358	66X0003-001	358
<b>CBS COLUMBIA</b>		CR32077-1	358	68X0003-001	358
63000061	358	105330	358	105330	358
<b>CORONADO</b>		<b>PACKARD BELL</b>		<b>TV MFRS OF AMERICA</b>	
CX-9000	358	72020	358	CX-9000	358
66X0003-001	358	72059	358	<b>WESTINGHOUSE</b>	
68X0003-001	358	<b>PANASONIC</b>		296V001H01	358
105330	358	TSS-616-1	358	296V001M01	358
<b>CURTIS MATHES</b>		<b>PENNCREST</b>		296V023C	358B
3.58MC	358	66X0003-001	358	690V38H25	358
9A1	358	68X0003-001	358	<b>ZENITH</b>	
09A001-00	358	105330	358	103-28	358
<b>DEL MONICO</b>		<b>PHILCO</b>		103-71	358
A04021	358	34-0012	358	103-89	358
QC-1	358	34-8028	358		
<b>DOMINION</b>		34-8034-4	358		
37-8-1	358				

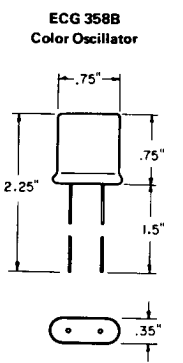
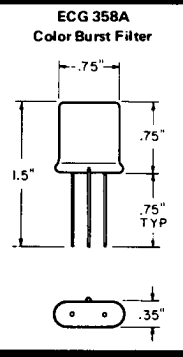
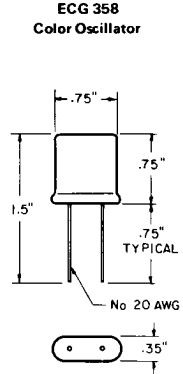



# CANADIAN RECEIVERS

## replacement guide by Set Manufacturer

Type To Be Replaced	Sylvania ECG Replacement	Type To Be Replaced	Sylvania ECG Replacement	Type To Be Replaced	Sylvania ECG Replacement	Type To Be Replaced	Sylvania ECG Replacement
<b>FLEETWOOD</b>							
		XB102	100	800-527-00	100	14-585-01	126
		XB103	102	800-529-00	103	14-586-01	104
16A1	123	XB104	102			14-587-01	102
16A2	123	XB112	102			14-588-01	126
79F015	109	XB113	102	<b>ELECTROHOME</b>		14-589-01	104
C83-829	116, 117			14-501-01	113	14-590-01	104
C83-880	116, 117	XB114	102	14-501-02	113	14-591-01	126
		XC101	102	14-503-01	114	14-600-01	126
86-1-3	116, 117	XC121	102	14-503-02	114	14-600-02	126
86-3-1	114	XC131	102	14-503-03	114	14-600-04	126
86-3-3	116, 117	XC141	104				
86-9-3	116, 117			14-503-04	114	14-600-07	126
86-47-3	116, 117(3)	XC142	104	14-504-01	109	14-600-10	126
		XC155	104	14-504-04	114	14-600-11	126
86-55-3	120	XC156	104	14-509-01	142	14-600-13	126
86-56-3	120	XC171	102	14-509-02	135	14-600-16	126
DTG110	104	77-270993-1	116, 117	14-510-01	110	14-600-19	126
E4676B	116, 117	78-254566-1	116, 117	14-511-01	109	14-600-20	126
SR14	116, 117	78-254566-4	116, 117	14-512-01	109	14-600-22	126
SR15	114	78-271030-1	116, 117	14-513-01	109	14-601-01	104
TF65	102	78-271143-1	116, 117	14-513-10	104	14-601-02	104
		78-271199-1	109				
<b>CLAIRTONE</b>				14-514-01	109	14-601-03	104
AF102	126	78-271228-1	109	14-514-02	116, 117	14-601-04	104
AF114	126	93K2-1	113	14-514-04	110	14-601-05	104
AF115	126	800-002-00	110	14-514-05	109	14-601-06	121
AF116	126	800-003-00	109	14-514-06	109	14-601-07	121
AF117	126	800-004-00	142				
		800-005-00	109	14-514-08	109	14-601-08	104
AF118	126	800-007-00	113	14-514-09	109	14-601-09	104
AF178	126	800-010-00	116, 117	14-514-10	109	14-601-10	130
IN87A	106	800-011-00	119	14-514-11	110	14-601-11	104
IN541	109	800-013-00	116, 117	14-514-12	109	14-601-12	130
IN542	110						
		800-017-00	118	14-514-13	110	14-601-13	130
OC45	100	800-020-00	109	14-514-14	109	14-601-15	130
OC71	126	800-021-00	109	14-514-15	109	14-601-16	130
OC72	126	800-022-00	109	14-514-16	109	14-602-01	128
OC74	102	800-023-00	142	14-514-17	109	14-602-02	123
OC75	102						
		800-501-00	123	14-514-18	116	14-602-03	123
OC169	126	800-502-00	102	14-514-19	116, 117	14-602-04	102
OC170	126	800-503-00	103	14-515-01	142	14-602-05	102
OC304	102	800-504-00	126	14-515-02	135	14-602-10	102
OC602	102	800-505-00	100	14-515-03	142	14-602-11	102
OC604	102						
		800-506-00	102	14-515-04	138	14-602-12	123
PT510	116, 117	800-507-00	121	14-515-07	145	14-602-13	123
XB1	102	800-509-00	123	14-515-11	145	14-602-14	108
XB2	102	800-510-01	130	14-515-13	138	14-602-15	102, 103
XB3	102	800-515-00	108	14-515-15	135	14-602-16	128
XB3B	102						
		800-516-00	126	14-574-10	104	14-602-17	128
XB3C	102	800-517-00	109	14-575-10	123	14-602-18	128
XB4	103	800-521-01	108	14-577-10	102	14-602-19	128
XB5	104	800-521-02	108	14-578-10	104	14-602-20	126
XB7	104	800-522-01	108	14-579-10	104	14-602-21	103
XB8	126						
		800-522-02	108	14-580-01	126	14-602-22	108
XB9	126	800-523-01	126	14-581-01	126	14-602-23	108
XB10	100	800-523-02	126	14-582-01	126	14-602-24	128
XB12	128	800-524-002	130	14-583-01	123	14-602-25	123
XB13	100	800-526-00	108	14-584-01	102	14-602-26	108
XB14	104						

## CANADIAN RECEIVERS (Cont'd)

Type To Be Replaced	Sylvania ECG Replacement	Type To Be Replaced	Sylvania ECG Replacement	Type To Be Replaced	Sylvania ECG Replacement	Type To Be Replaced	Sylvania ECG Replacement
<b>ELECTROHOME (cont'd)</b>							
14-602-27	102, 103	14-602-55	128	28-22-01	116, 117	28-26-01	116, 117
14-602-28	126	14-602-56	128	28-22-02	116, 117	1P542	109
14-602-29	128	14-602-58	106	28-22-03	116, 117	S1907	130
14-602-30	108	14-602-59	128	28-22-04	116, 117	T1503	100
14-602-31	108	14-602-60	106	28-22-05	116, 117	11252	109
14-602-32	108	14-602-61	108	28-22-06	116, 117	15027	104
14-602-34	108	14-602-62	108	28-22-08	116, 117	49022	104
14-602-35	108	14-602-63	128	28-22-09	116, 117	40050	104
14-602-36	154	14-603-01	128	28-22-10	116, 117	106379	116, 117
14-602-37	154	14-603-02	128	28-22-11	116, 117	109474	113
14-602-41	108	14-603-03	108	28-22-12	116, 117	113391	119
14-602-43	128	14-603-04	108	28-22-13	116, 117	113392	116, 117
14-602-44	108	14-603-05	108	28-22-14	116, 117	113397	118
14-602-45	108	14-603-06	123	28-22-15	116, 117		
14-602-46	123	14-603-07	128	28-22-16	116, 117		
14-602-47	106	14-604-08	121	28-22-17	116, 117		
14-602-48	108	28-6-01	116, 117	28-22-19	125, 156		
14-602-49	108	28-18-01	116, 117(4)	28-22-21	116, 117		
14-602-50	123	28-19-01	116, 117	28-23-01	118		
14-602-54	106	28-21-01	116, 117	28-24-01	119		



**SYLVANIA**  
GENERAL TELEPHONE & ELECTRONICS