



TH 9896

ULTRA VIOLET SENSITIVE 1" VIDICON

- ELECTROMAGNETIC FOCUS AND DEFLECTION
- HIGH RESOLUTION
- LOW LAG

The TH 9896 is a magnetic focus and deflection 1" Vidicon designed for ultra-violet sensitive television cameras. It incorporates a quartz window and a special target allowing high sensitivity in the ultra-violet region of spectrum. The special response curve has a peak at 400 nm and the corresponding sensitivity is approximately $0.2 \mu\text{A}/\mu\text{W}/\text{cm}^2$. At 250 nm the sensitivity is about $0.1 \mu\text{A}/\mu\text{W}/\text{cm}^2$ while the sensitivity for wavelength beyond 600 nm is practically negligible.

Due to a low lag photoconductive layer featuring unity gamma, excellent images can be displayed on a television screen so making the tube to be recommended for use in ultra-violet television microscopy.

A post-acceleration electrode with separate external connection provides higher resolution, higher output signal capability as well as better resolution and signal uniformity than previous Vidicons. For optimum beam landing and resolution, the post-acceleration voltage should be adjusted at 1.5 to 1.6 times the wall electrode voltage.

Due to good design, high reliability is obtained all along tube life. Requirement for alignment field is reduced to a minimum owing to precise electron gun mounting. An extremely flat face plate avoids all optical distortions and enables the use of any high aperture lenses.

Low heater power consumption makes this Vidicon suitable for all transistorized equipment. The low heat dissipation improves the quality of image by lowering the operating temperature of the faceplate.

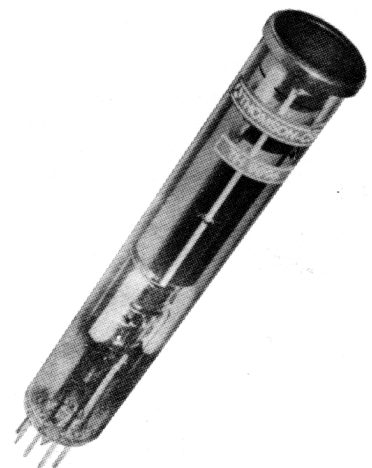

GENERAL CHARACTERISTICS

Electrical

Heating	for unipotential cathode indirectly heated
Heater :	
- Voltage	$6.3 \pm 10 \%$ V
- Current	0.15 A
Minimum preheating time	60 s
Output capacitance :	
Target to all other electrodes	4.5 pF
Spectral response	See curve
Deflecting method	Magnetic
Focusing method	Magnetic



Mechanical

Base	Ditetrar 8 pins (JEDEC N° E8 - 11)	
Socket	METOX N° 30.250	
Deflecting yoke	GERHARD	
Dimensions	See drawing	
Photoconductive layer :		
- normal dimensions of image on target	12.7 x 9.5	mm
- maximum useful diagonal diameter (4 x 3 aspect ratio) ..	17	mm
- orientation scan parallel to the plane passing through the tube axis and short index pin.		
Maximum temperature of faceplate	60	°C
Operating position	Any	
Net weight, approximate	60	g

OPERATING POSITION

Maximum ratings

Scanned area 12.7 x 9.5 mm

Electrode g4 voltage (post acceleration electrode)	1000	V
Electrode g3 voltage (wall electrode)	750	V
Electrode g2 voltage (acceleration)	700	V
Electrode g1 voltage (modulator) :		
- negative bias value	-150	V
- positive bias value	0	V
Target voltage	100	V
Dark current	0.1	μA
Faceplate :		
- illumination	1000	f.c.
- temperature	60	°C

Typical operation

*Scanned area 12.7 x 9.5 mm
Faceplate temperature 25 °C*

Electrode g4 voltage	420 to -450	V
Electrode g3 voltage	280 to 300	V
Electrode g2 voltage	300	V
Electrode g1 voltage	-35 to -75	V
Minimum blanking peak to peak voltage :		
- applied to electrode g1	-75	V
- applied to cathode	+10	V
Limiting resolution at center of picture	800	TV lines
Limiting resolution at corner of picture	500	TV lines
Axial magnetic field	40	Gauss
Adjustable tranverse alignment field	± 4	Gauss
Signal electrode voltage	10 to 20	V
Dark current	0.5	nA
Sensitivity		
- at 400 nm	0.2	μA/μW/Cm ²
- at 250 nm	0.1	μA/μW/Cm ²



SPECTRAL RESPONSE

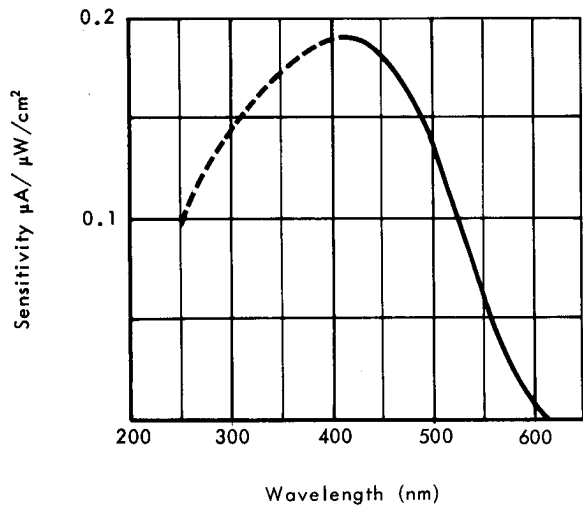

SIGNAL CURRENT VS INCIDENT ENERGY AT 253.7 nm

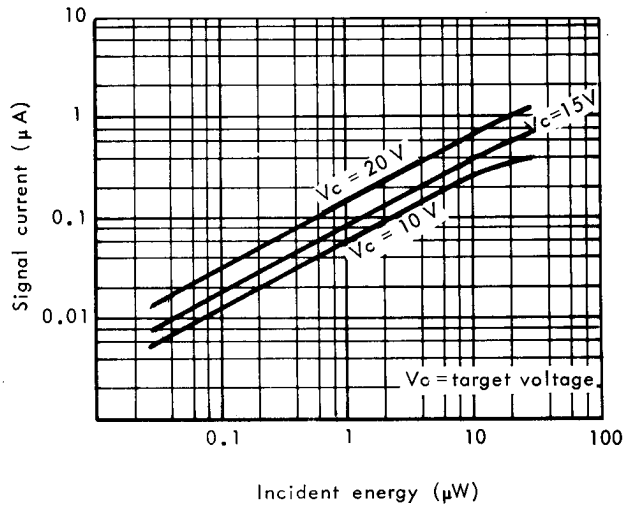

SIGNAL CURRENT VERSUS TARGET VOLTAGE

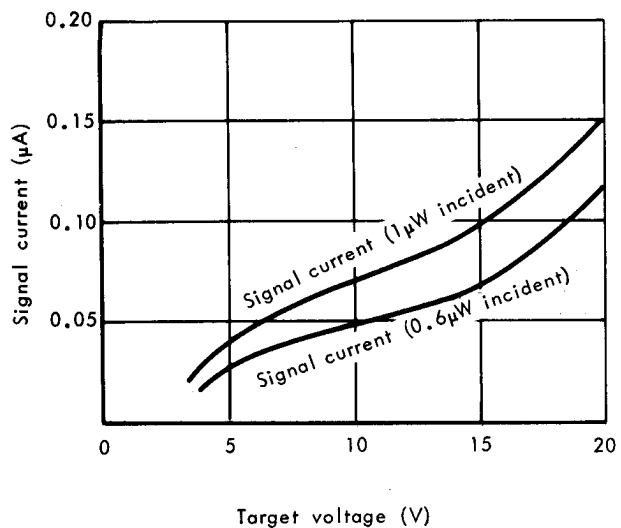

DARK CURRENT VERSUS TARGET VOLTAGE

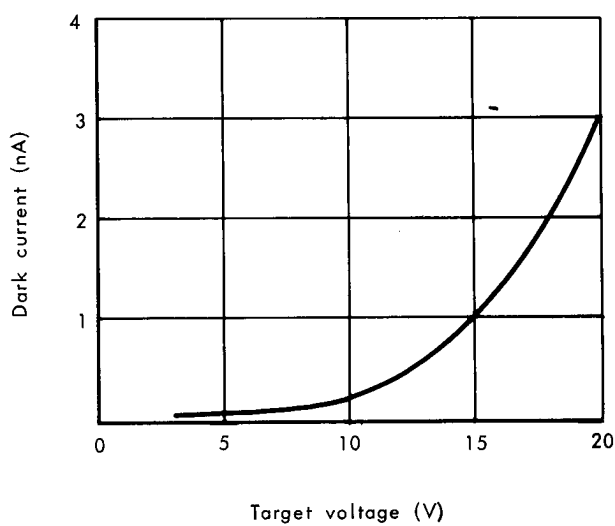



OUTLINE DRAWING

BASING DIAGRAM

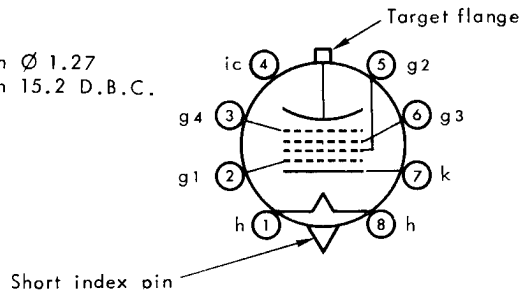
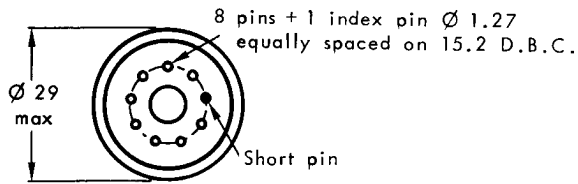

1 - Heater	5 - Electrode g2
2 - Electrode g1	6 - Electrode g3
3 - Electrode g4	7 - Cathode
4 - Internal connection	8 - Heater

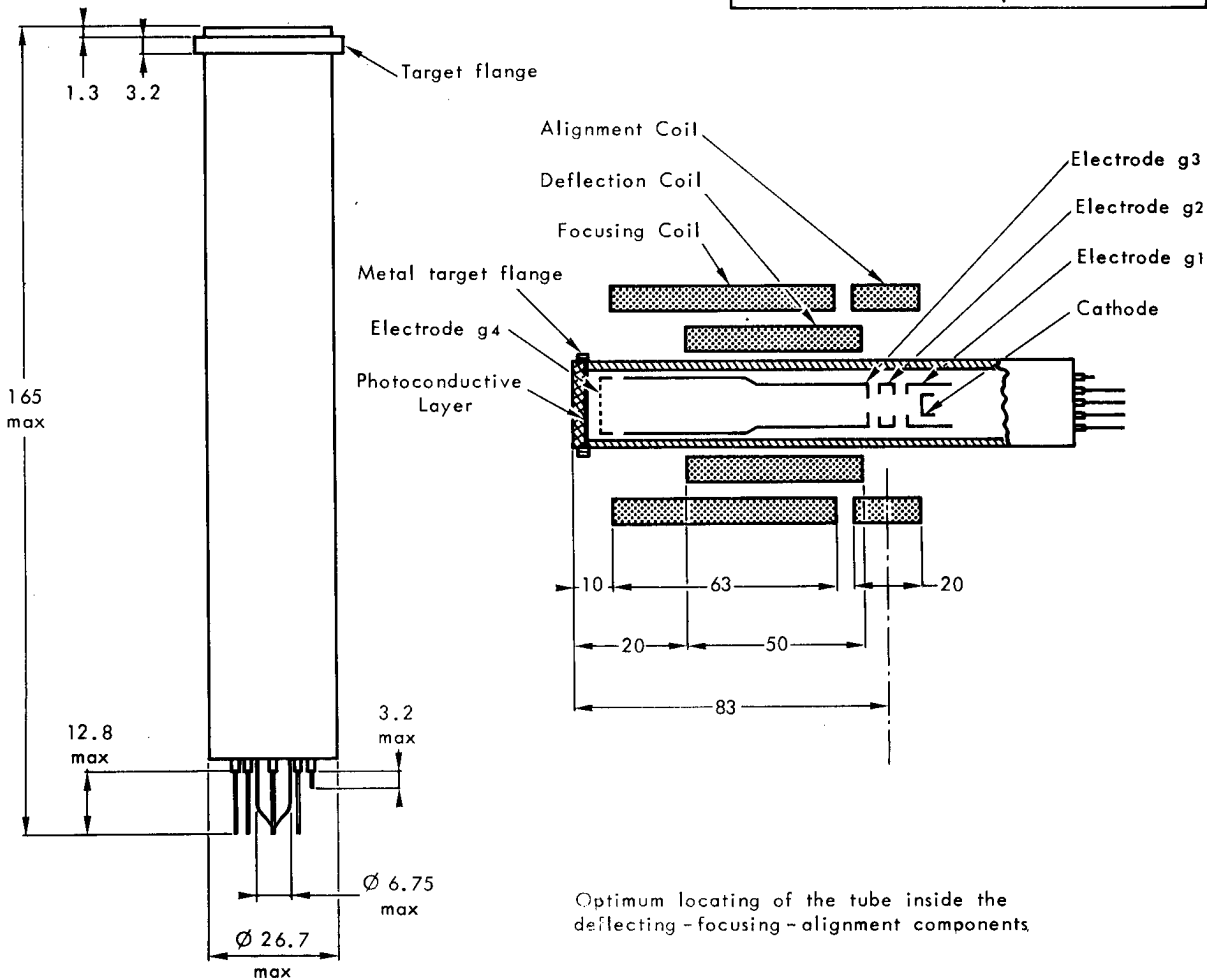

Optimum locating of the tube inside the deflecting - focusing - alignment components.

Dimensions in mm.

