



BRIMAR



RADIO VALVES

BRIMAR

VALVES TRADE MARK



Standard Telephones and Cables Limited

(Radio Receiving Valve Division)

VALVE WORKS
FOOTS CRAY, KENT

Telephone No. : SIDCUP 960



BRIMAR

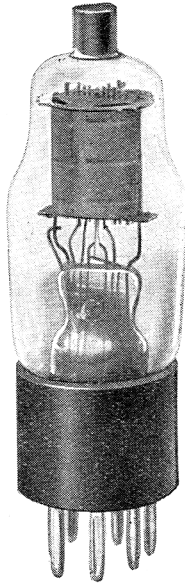

HEPTODE FREQUENCY CHANGER TYPE 15D.1

The BRIMAR 15D.1 is an indirectly heated frequency changer of the heptode or pentagrid type suitable for use in A.C. Universal or Automobile receivers. It is designed to perform simultaneously the functions of mixer and oscillator in receivers of the super-heterodyne class.

These functions are accomplished in a single valve comprising a triode unit and a screened grid or tetrode unit coupled by a common electron stream.

The triode unit functions as an oscillator, the oscillations modulating the electron stream of the tetrode unit, producing in the anode circuit the required I.F. frequency.

The tetrode portion of the valve is designed with a variable mu characteristic; thus enabling the conversion gain to be varied over a wide range by variation of tetrode control grid bias.

Great care has been taken in the design of this valve to eliminate frequency drift. How far the designers have been successful may be gathered from the following information. At 1,500 K.C. the application of 40 volts bias to the grid of the tetrode portion produces a frequency drift of less than 150 cycles.

Operation details and characteristics are given overleaf. The valve is fitted with a seven-pin base, connections being as shown on page 51.

BRIMAR

CHARACTERISTICS

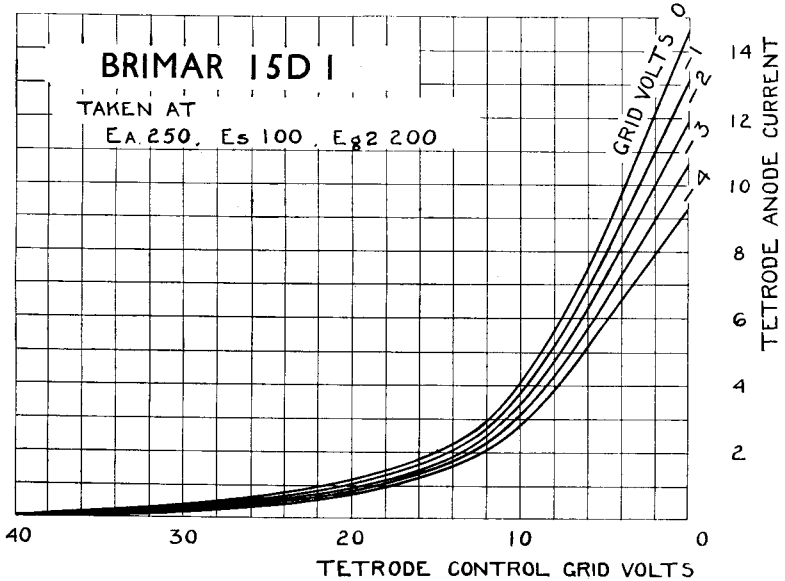

Heater Voltage	13.0 volts
Heater Current	0.2 amp.
Tetrode Anode Voltage (maximum)	250 volts
Screen Voltage (maximum)	100 volts
Triode Anode Voltage (maximum)	200 volts
Conversion Conductance	550 micromhos*

* Taken at anode volts (tetrode) 250, screen volts 100.
 anode volts (triode) 200, control grids—3 volts.

APPROXIMATE OPERATING CONDITIONS

Anode Volts	250	150	100
Screen Volts (G.3 & 5)	100	100	50
Triode Anode Volts (G.2)	200	120	100
Grid Volts (G.4)	-3.0	-2.5	-1.5
Grid Leak (G.1) (ohms)	50,000	25,000	10,000
Auto Bias Resistance (ohms)	300	300	150
Screen Supply Resistance (ohms)	—	15,000	20,000
Triode Anode Supply Resistance (ohms)	15,000	10,000	—
Anode Current (mA.)	3.5	3.0	1.5
Screen Current (mA.)	2.0	2.5	2.5
Triode Anode Current (mA.)	4.0	4.0	3.5

VALVES

BRIMAR

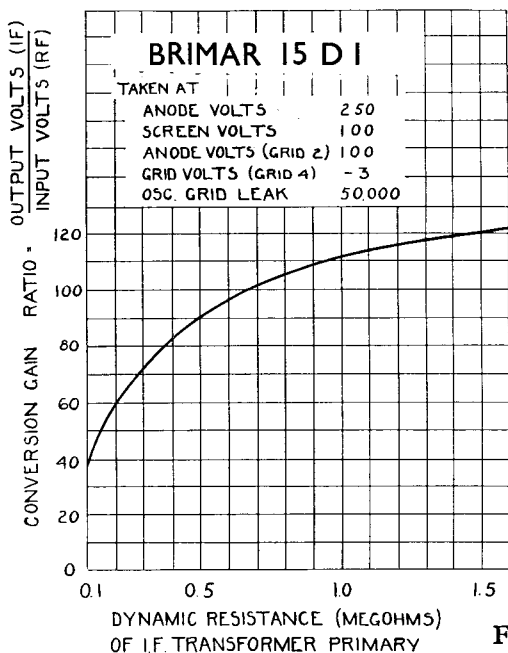
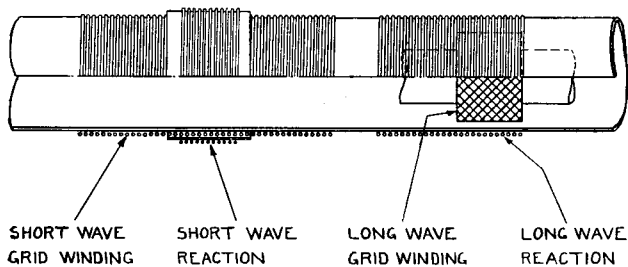

Fig. 1.



LONG WAVE GRID WINDING:- WAVE WOUND OR HONEYCOMB
ON 1/2" OR 5/8" DIA. MANDREL.
OTHER WINDINGS :- ON 1" DIA. FORMER.
S.W. REACTION INSULATED
FROM S.W. GRID WINDING

Fig. 2.

VALVES

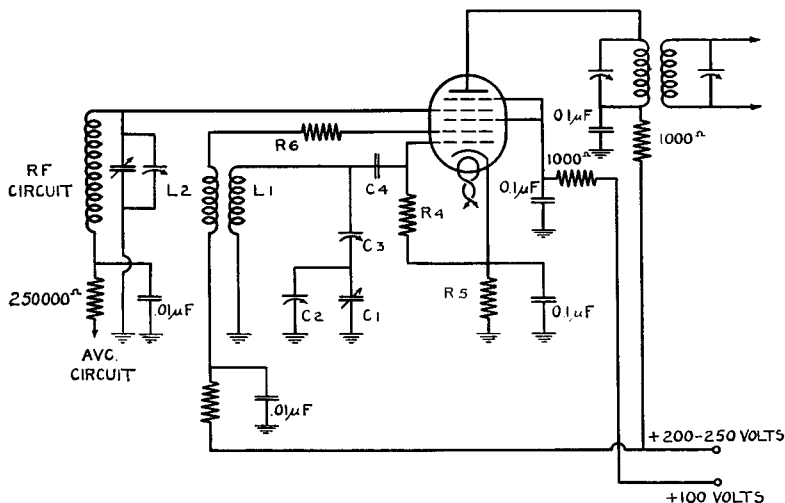

Fig. 3.

The curve on page 4 shows the tetrode anode current characteristic for various values of triode grid voltage. Fig. 1 page 5 gives the variation of conversion gain against dynamic resistance of the I.F. transformer primary.

Under operating conditions the conversion gain of a BRIMAR 15D.1 (used in a circuit as Fig. 3 above) measured from the grid of the valve (G.4) to the grid of the I.F. amplifier using a reasonably efficient step-up I.F. transformer will be of the order of 200 times.

In Fig. 3, which is a typical circuit employing a 15D.1, L.1, L.2 is the oscillator coil assembly; C.1 is the oscillator section of the condenser gang; C.3 is the padding or tracking condenser; C.4 and R.4 are the grid condenser and leak, which should have values of approximately .0001 mfd. and 50,000 ohms respectively; R.6 is a damping resistance wired as close as possible to the triode anode socket G.2 to prevent the possibility of spurious frequencies being produced, it may have a value of 1,000 to 6,000 ohms as may be required; R.5 is the auto bias resistor of from 150 to 300 (see table on page 4).

In order to obtain the maximum conversion gain with stability the valve should be shielded and the lead to the top cap made as short as possible.

BRIMAR

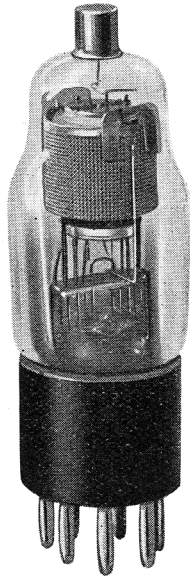

R.F. VARIABLE MU PENTODE TYPE 9D.2

The BRIMAR 9D.2 is an indirectly heated radio frequency pentode valve, suitable for use in A.C., universal or automobile receivers.

The variable mu characteristic eliminates the possibility of cross modulation or modulation distortion occurring when the valve is handling inputs usually associated with the R.F. or I.F. stages of a radio receiver. It also enables the gain of the valve to be varied over a wide range by the application of a varying control grid voltage, thus rendering the valve particularly suitable for use in receivers employing automatic volume control. The high mutual conductance at minimum operating grid bias, coupled with the low anode grid leakage capacity, enables extremely high stage gains to be obtained with complete stability.

In order to obviate the possibility of mains hum being introduced into the grid circuit, the control grid is brought out to the top cap. The valve is fitted with a seven-pin base, the connections being as shown on page 51.

BRIMAR

CHARACTERISTICS

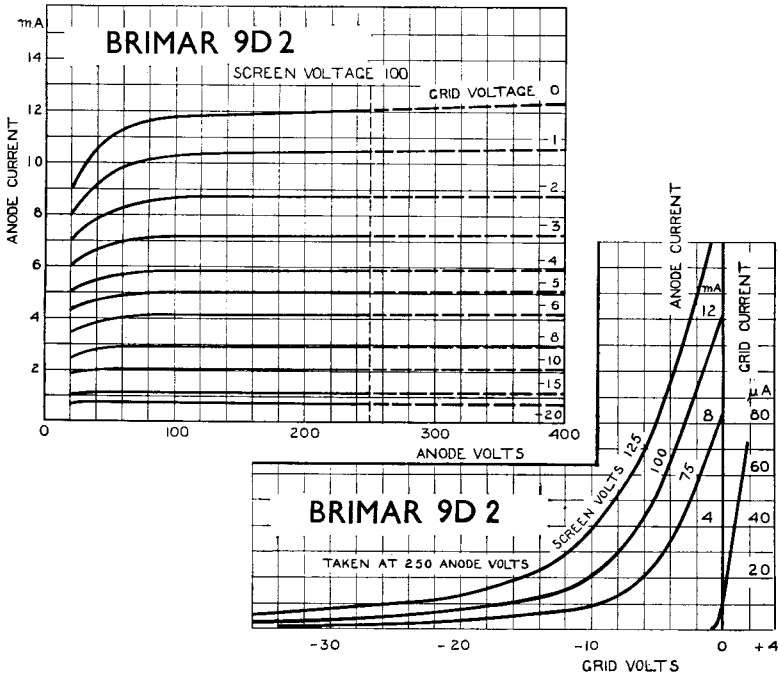

Heater Voltage	13 volts
Heater Current	0.2 amps.
Anode Voltage (maximum)	250 volts
Screen Voltage	125 volts
*Mutual Conductance mA./V.	1.65
*Impedance (ohms)	600,000
*Amplification Factor (M.)	1,000
†Mutual Conductance mA./V.	0.01

* Taken at anode volts 250, screen volts 125, grid volts -3

† Taken at anode volts 250, screen volts 125, grid volts -40

OPERATING DATA

Anode Voltage	250	200	140	95
Screen Voltage	125	100	100	95
Anode Current (mA.)	10.0	7.0	6.5	6.0
Screen Current (mA.)	3.5	2.5	2.5	2.0
Auto Bias Resistor (ohms)	200	300	300	400

BRIMAR

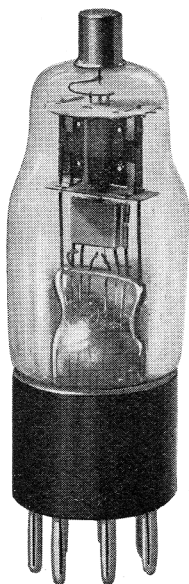

DOUBLE DIODE TRIODE TYPE 11D.3

The BRIMAR 11D.3 is an indirectly heated double diode triode valve suitable for use in A.C., universal or automobile receivers. It is designed for performing simultaneously the functions of automatic volume control, detection and amplification.

Full-wave or half-wave rectification together with delayed A.V.C., or delayed and amplified A.V.C. may be employed.

To prevent R.F. or I.F. voltages causing instability, by passing into the L.F. stages, the diodes are efficiently screened from the triode portion by an electrostatic screen connected to the cathode.

Operating details and characteristics are given overleaf.

The valve is fitted with a seven-pin base, connections being as shown on page 51.

BRIMAR

CHARACTERISTICS

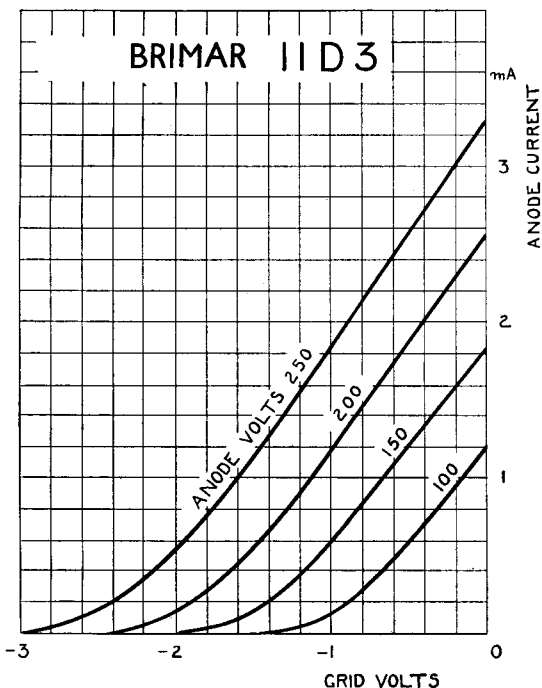

Heater Voltage	13.0 volts
Heater Current	0.2 amp.
Anode Voltage (maximum)	250 volts
*Mutual Conductance (mA./V.)	1.2
†Mutual Conductance (mA./V.)	1.1
†Impedance (ohms)	90,000
†Amplification Factor	100

* Taken at anode volts 100, grid volts 0.

† Taken at anode volts 250, grid volts -2.

INTER-ELECTRODE CAPACITIES

Anode to Grid...	2.0 m.mf.
Anode to Cathode	4.0 m.mf.
Grid to Cathode	2.0 m.mf.
Diode to Cathode	4.0 m.mf. each

BRIMAR

OPERATION

The Standard BRIMAR Valve type 11D.3 is intended for use in A.C., Universal or car receivers as a diode detector and L.F. amplifier. The heater should be wired up in parallel with other valves of the same class in the case of A.C. or car receivers or in series with others of the Brimar A.C./D.C. series in the case of A.C./D.C. receivers. The heater is so designed that it introduces no hum into the circuits, while its heater-cathode insulation is capable of withstanding 240 volts.

The valve is primarily designed for use as a second Detector and first L.F. Amplifier in superheterodyne receivers employing automatic volume control, the double diodes may be used in any circuit where diodes can be employed, while the triode may be utilised as a high gain amplifier stage for L.F. or A.V.C. voltage or both.

In operation the triode should be resistance capacity coupled to the output stage and an anode resistance of from 100,000 ohms to 250,000 ohms used. The auto bias resistance where used being between 5,000 and 10,000 ohms. The diodes may be used either as a half-wave or full-wave rectifier, in both cases the load resistance should be about $\frac{1}{2}$ to $\frac{1}{4}$ megohm and the shunting condenser have a value of about '0003 m.mf. The curve Fig. 1 shows the rectification characteristic of one diode ; load lines for various valves of load resistance are shown.

Fig. 2 shows a typical circuit using a Brimar Type 11D.3 valve suitable for an A.C./D.C. or car receiver. In this circuit one diode is used for obtaining the L.F. output and the other the A.V.C. voltage, the latter is delayed by the bias voltage existing across the auto bias resistance R.7.

The modulated I.F. carrier is rectified for the L.F. output by diode D.1, the L.F. voltage being set up across the resistance R.1. The resistance R.2 and condenser C.3 provide a filter to remove any carrier from the L.F. output. The filtered L.F. reaches R.3 the manual volume control, *via* the switch S.1 and the condenser C.4. The switch S.1 in the alternative position connects the Pick Up to R.3 through C.4. It is necessary when using a Pick Up with an A.C./D.C. receiver to have a condenser in each lead (C.4 and C.5) to eliminate the possibility of shock. The other diode D.2 receives I.F. carrier through C.1, whose capacity is determined by experiment depending on the magnitude of A.V.C. voltage required and the damping allowable on the I.F. transformer. The rectified carrier sets up the A.V.C. voltage across R.4, R.5 and C.7 being a decoupling circuit.

OPERATING DATA

Anode Voltage	250	250	150	150
Anode Resistance (ohms)	250,000	100,000	250,000	100,000
Grid Voltage	1.7	2.0	1.5	1.7
Auto Bias Resistance (ohms)	5,000	5,000	10,000	10,000
Anode Current (mA.) ...	0.35	0.4	0.15	0.17

VALVES

BRIMAR

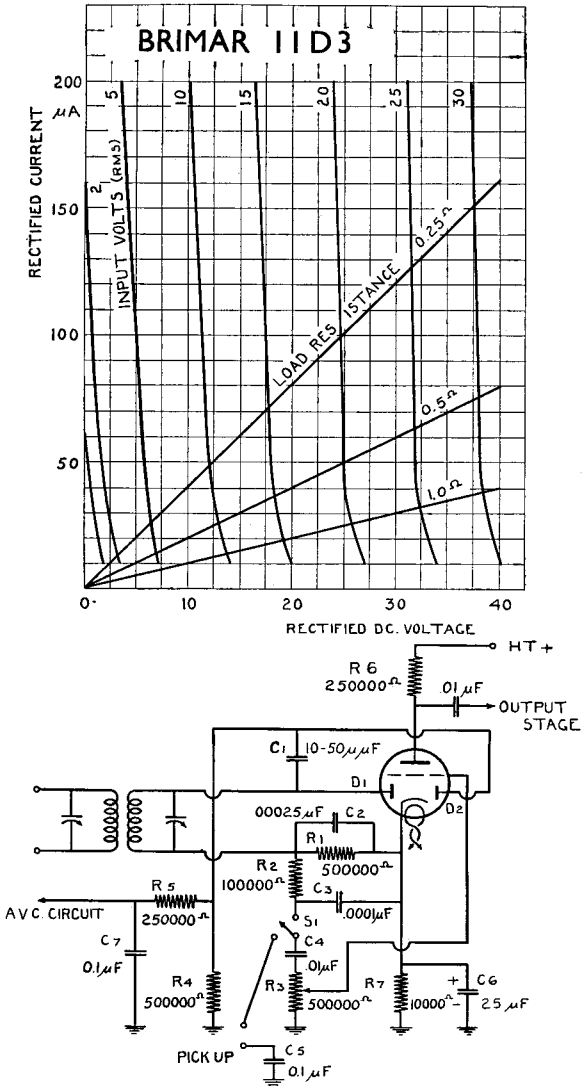
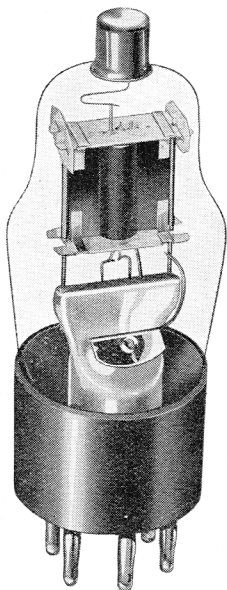

Fig. 2.

VALVES

BRIMAR



TRIODE TYPE 4D.1

The BRIMAR 4D.1 is an indirectly heated triode suitable for use in A.C., universal, or automobile receivers.

It is eminently suitable for use as a detector of the grid leak and condenser or anode bend (grid biased) type, operating details being given overleaf.

It will also perform very satisfactorily as a separate oscillator in receivers of the superheterodyne class.

When used as an L.F. Amplifier automatic bias is strongly recommended.

BRIMAR

CHARACTERISTICS

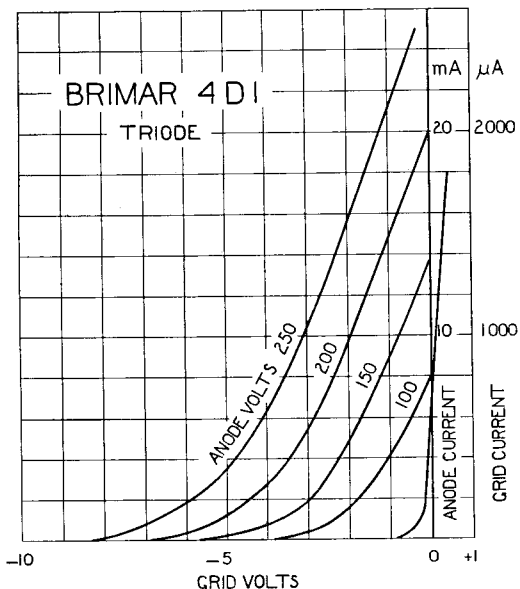

Heater Voltage	13.0 volts
Heater Current	0.2 amps.
Anode Voltage (Max.)	250 volts
*Mutual Conductance	4.0 mA./V.
*Amplification Factor	40
*Impedance	10,000 ohms

* Taken at anode volts 100, grid volts 0

OPERATING DATA

Anode Voltage	200	150	100
Anode Current (mA.)	5.0	3.0	2.5
Grid Bias (volts)	-3.0	-2.5	-1.5

Auto Bias Resistor (ohms) 800 as amplifier
20,000/200,000 as biased detector.

Grid Leak detector	Anode volts	250
	Anode resistor	25,000 ohms
	Grid Condenser	.0002
	Grid Leak	1-2 megohms

VALVES

BRIMAR

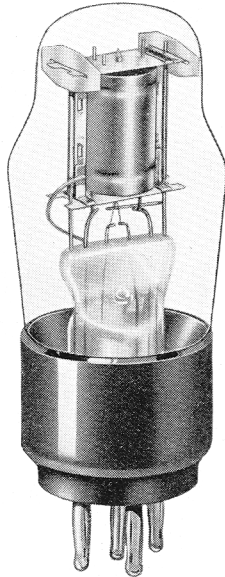

UNIVERSAL DOUBLE DIODE TYPE 10D.1

The 10D.1 is an indirectly heated double diode valve suitable for use in A.C., universal, or automobile receivers. The double diode rectifying system provides for the use of half or full wave rectification, together with any of the usual forms of automatic volume control.

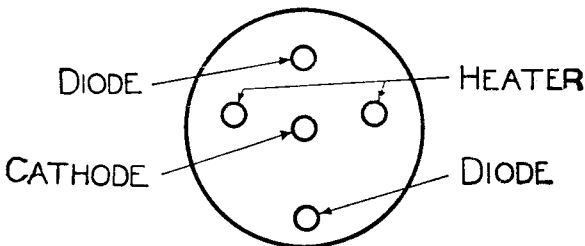

TYPE 10D.1 BASE CONNECTIONS
HEATER CHARACTERISTICS 13 VOLTS 0.2 AMPS.

VALVES

BRIMAR

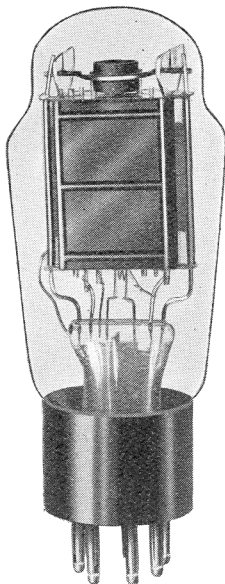

HIGH SLOPE POWER PENTODES TYPES 7A.3, 7D.6 and 7D.8

The BRIMAR 7A.3, 7D.6, and 7D.8, are indirectly heated high slope power pentodes covering the whole range of requirements for A.C., universal and automobile receivers respectively.

The sensitivity is such that with an input of 2.0 volts R.S.M. (200 volts on screen), the valves are fully loaded, thus dispensing with the intermediate L.F. stage usually required. Owing to the high efficiency attained, it is recommended that a resistor of the order of 100 ohms be connected in the anode circuit, in addition to the usual grid circuit stopper, to prevent the generation of parasitic oscillations. The use of automatic bias is strongly recommended, care being taken to shunt the resistor with a by-pass condenser of adequate capacity, in order to obtain the maximum sensitivity and preserve the lower register.

Operation details and characteristics are given overleaf. The valves are fitted with seven pin bases, connections being as for the 7A.2 on page 51 of the BRIMAR Catalogue.

VALVES

BRIMAR

CHARACTERISTICS

	7A.3	7D.8	7D.6
Heater Voltage	4.0	13	40 volts
Heater Current	2.0	0.65	0.2 amps
Anode Voltage (max.)	250	volts
Screen Voltage (max.)	250	volts
Mutual Conductance	*10	mA./V.
Mutual Conductance	†10	mA./V.
Impedance	†60,000	ohms
Amplification Factor	†600	
Maximum Anode Current	40	mA.

* Taken at anode and screen volts 100, grid volts 0

† Taken at anode and screen volts 250 grid volts -6.

APPROXIMATE OPERATING CONDITIONS

Anode Volts	250	200	150
Screen Voltage	250	200	150
Anode Current (mA.)	31	31	30
Grid Bias (volts)	-6	-4	-2
Auto-Bias Resistance (ohms)	150	100	60
Load Impedance (ohms)	8500	8700	8900

BRIMAR

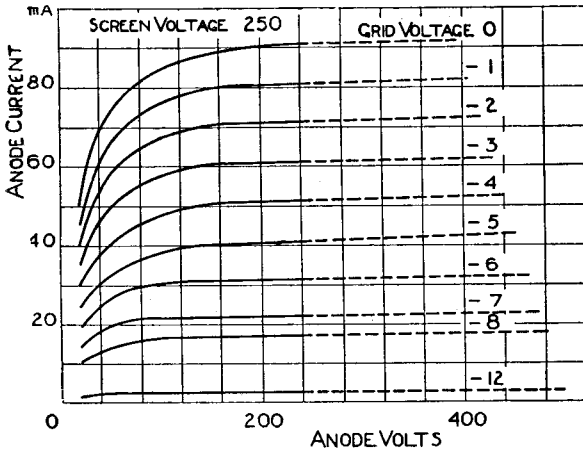
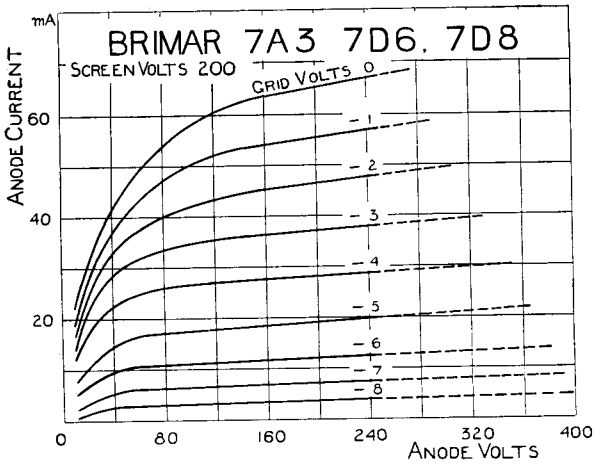

VALVES

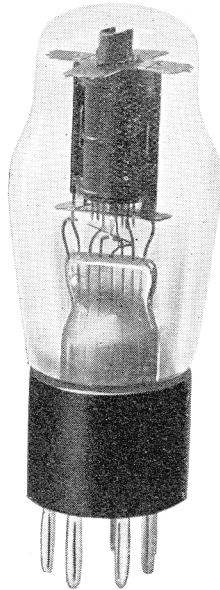

UNIVERSAL POWER PENTODE TYPE 7D.3

The 7D.3 is an indirectly heated high efficiency output pentode for use in A.C. Universal receivers.

The valve is capable of giving a generous output with 90 volts on anode and screen, rendering the valve extremely useful for receivers intended for use on 110 volt mains.

The maximum anode and screen voltage is 150, so that in receivers designed for the 200/250 volt mains the speaker field may still be used for smoothing purposes, thus simplifying and reducing the cost of this unit.

When automatic bias is employed, the resistor should be shunted with a condenser of at least 4 mfd. or a suitable filter network in order to utilise the full gain of the valve and preserve the lower register.

Operation details and characteristics are given overleaf. The valve is fitted with a seven-pin base, the connections being as shown on page 51.

BRIMAR

CHARACTERISTICS

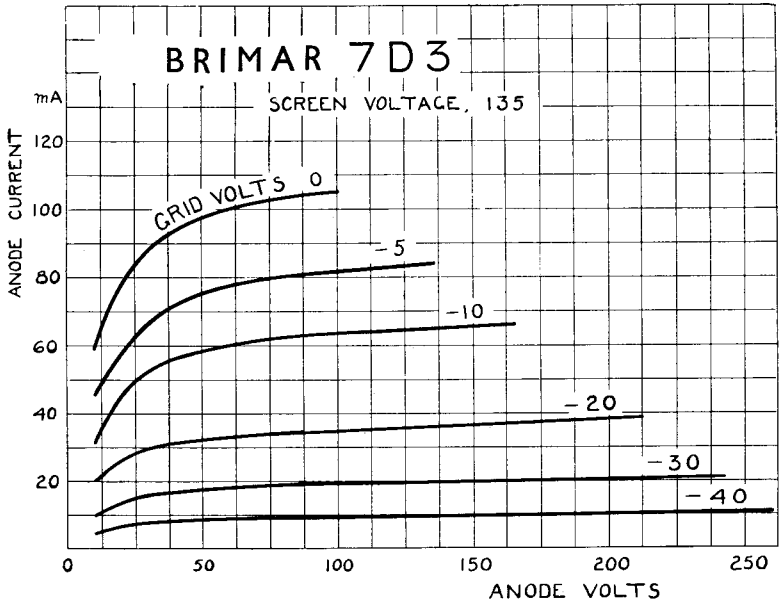

Heater Voltage	40.0 volts
Heater Current	0.2 amps
Anode Voltage (maximum)	150 volts
Screen Voltage (maximum)	150 volts
*Mutual Conductance	3.8 mA./V.
†Mutual Conductance	2.5 mA./V.
†Impedance	37,000 ohms
†Amplification Factor (M)	85
†Load Impedance	4,000 ohms

* Taken at anode and screen volts 100, grid volts 0

† Taken at anode and screen volts 135, grid volts -20.

OPERATING DATA

Anode Voltage	150	135	100
Screen Voltage	150	135	100
Anode Current (mA.)	40	35	20
Grid Bias (volts)	-22.5	-20	-15
Auto Bias Resistor (ohms)	450	500	600
Load Impedance (ohms)	3,750	4,000	4,500

VALVES

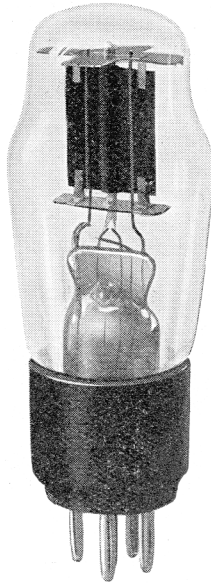

RECTIFIER TYPE 1D.5

The 1D.5 is an indirectly heated half-wave rectifier suitable for use in A.C. or universal receivers.

The electrodes are arranged so that very little voltage drop occurs in the valve, a most important point in rectifiers designed for use in this type of receiver.

The design is such that no hum is introduced into the circuits by the heater, while the heater cathode insulation is capable of withstanding a considerably greater voltage than is likely to be experienced in receivers for which it is designed.

The valve is fitted with a five-pin base, connections being as shown on page 51.

BRIMAR

CHARACTERISTICS

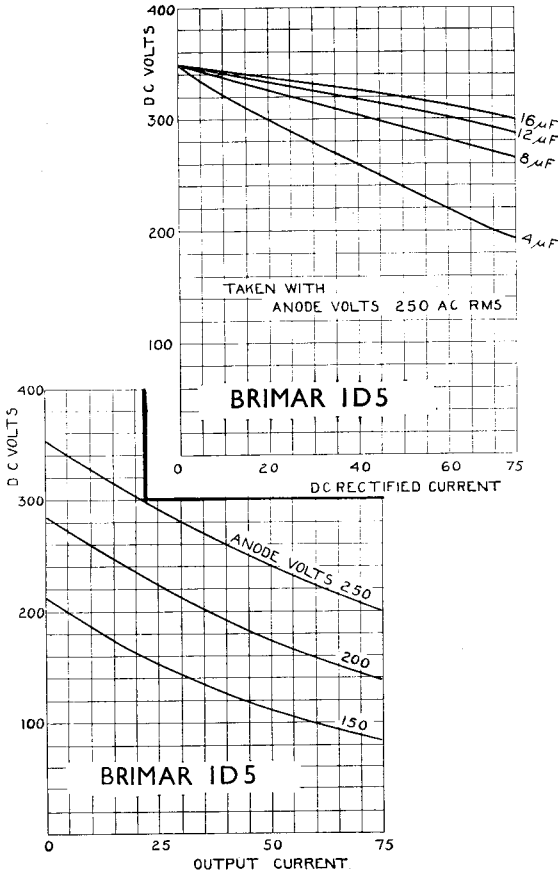

Heater Voltage	40 volts
Heater Current	0.2 amps.
Maximum Input Voltage	250 volts, R.M.S.
Rectified Current	75 m.a.

VALVES

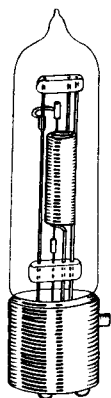

TRIODE TYPE 4215-A

Length: $2\frac{1}{8}$ " (5.4 cm.)

Diam.: $\frac{5}{8}$ " (1.6 cm.)

The No. 4215-A valve is a small light-weight "pea-nut" type valve, designed for radio reception work as an amplifier, detector, or oscillator. It has an oxide coated tape filament surrounded by a cylindrical grid and anode.

The base is fitted with a small type bayonet cap.

Valve socket required ... No. 4001. Price 1/6.

BRIMAR

CHARACTERISTICS

4215-A

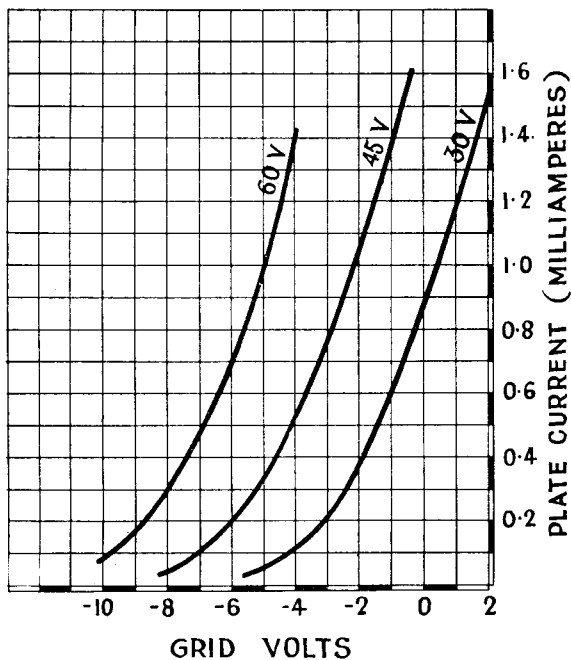

Filament Voltage	1	volt
Filament Current	0.25	amps.
Working Plate Voltage	45	volts
Working Plate Current	1	m.a.
Max. Plate Voltage	60	volts
Max. Dissipation	0.2	watts
Working Grid Voltage	-3	volts
Amplification Factor	6	
Impedance	25,000	ohms
Output as Oscillator	0.1	watt
Gain	24	db.

VALVES

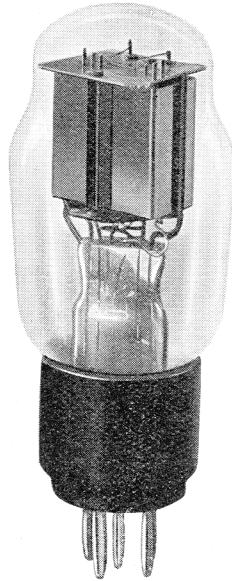

POWER PENTODE VALVE TYPE PEN.B.1

The BRIMAR Pen.B.1 valve has been designed to give the maximum undistorted output with the minimum consumption of H.T. current.

The sensitivity of the valve is of a very high order; with an input grid swing of approximately 3.2 volts R.M.S., the valve is fully loaded, the output being sufficient for the operation of the average moving coil speaker at considerable volume.

When speakers of the magnetic type are employed, they should be shunted with a filter, consisting of a condenser of .01 mfd. and a resistance of 50,000—100,000 ohms in series.

Anode Volts	150	125	100
Screen Volts	150	125	100
Grid Bias Volts	4.5	4.5	3.0
Anode Current mA.	8.0	4.5	4.0
Optimum Load Ohms (approx.)				18,000	28,000	25,000

BRIMAR

CHARACTERISTICS

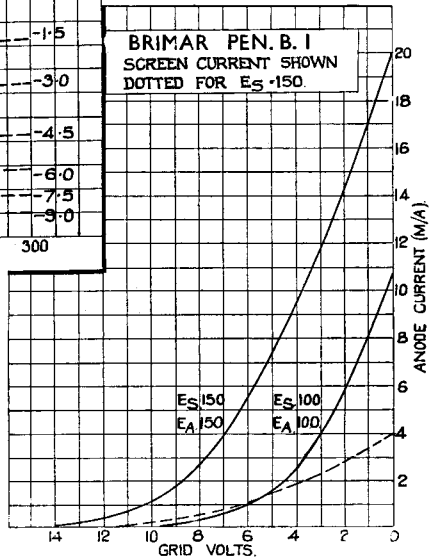
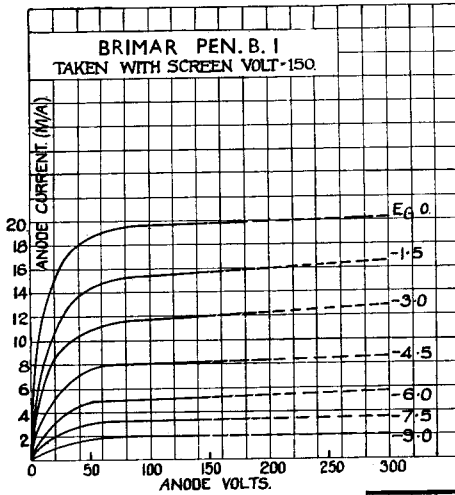

Filament Voltage	2.0 volts
Filament Current	0.2 amp.
Max. Anode Volts	150
Max. Screen Volts	150
Mutual Conductance	2.5 mA. per volt

VALVES

BRIMAR



TRIODE TYPE H.L.A.2

The BRIMAR H.L.A.2 is an indirectly heated triode valve of very robust construction.

The electrode system is interlocked in such a manner that mechanical variations are impossible, ensuring no change in the electrical characteristics, and an extremely low noise level.

Owing to the construction, microphonicity is non-existent, hence the valve can be used as a detector when followed by a high gain amplifier.

It also gives very good results as a low frequency amplifier, or as oscillator in superheterodynes, where reliability is of prime importance. The frequency drift even at ultra high frequencies being negligible. When used as an L.F. amplifier, automatic bias may be obtained by a resistance of approximately 400 ohms in the cathode lead.

Anode Volts	100	150	200
Grid Bias (approx.)	-1.0	-1.5	-2.5
Anode Current mA.	3.0	5.0	6.0

VALVES

BRIMAR

CHARACTERISTICS

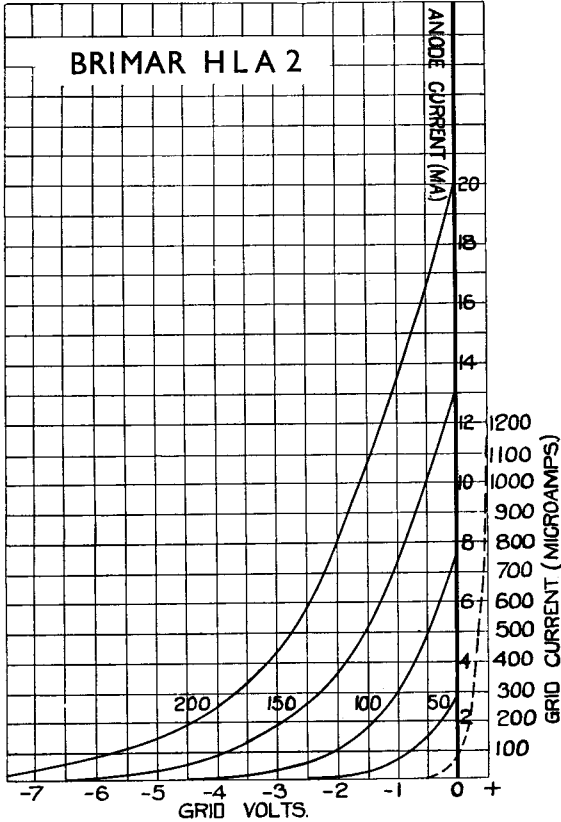

Heater Voltage	...	4 volts \pm 5%
Heater Current	...	1.0 amp.
Max. Anode Voltage	...	200 volts
*Impedance	...	9,000 ohms
*Amplification Factor	...	50
*Mutual Conductance	...	5.5 mA. per volt

*Measured at anode volts 100, grid bias zero.

BRIMAR



POWER TRIODE TYPE P.A.1

The BRIMAR P.A.1 is an indirectly heated power output valve capable of supplying sufficient power to operate a moving coil speaker, with an input grid swing of 7.5 volts R.M.S.

This sensitivity compares very favourably with that of a pentode.

Grid bias is most conveniently derived by including a resistance in the cathode lead of approximately 260 ohms. This should be shunted by a condenser of at least 4 mfd. in order to utilise the full gain of the valve and preserve the lower register.

Anode Volts	100	150	200
Grid Bias (approx.)	-4.5	-6.5	-10.5
Anode Current mA.	23	35	40

VALVES

BRIMAR

CHARACTERISTICS

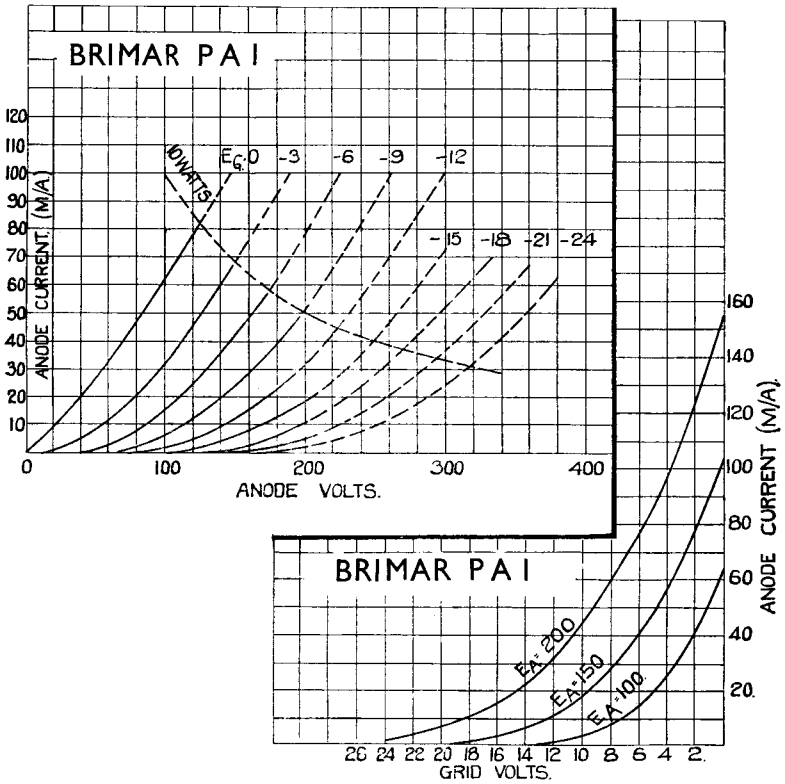

Heater Voltage	4.0 volts \pm 5%
Heater Current	1.0 amp.
Max. Anode Voltage	200 volts
Max. Anode Current	50 mA.
*Impedance	1,050 ohms
*Amplification Factor...	12.6
*Mutual Conductance	12 mA. per volt.
Optimum Load	4,000 ohms (approx.)

* Measured at anode volts 100, grid volts zero.

VALVES

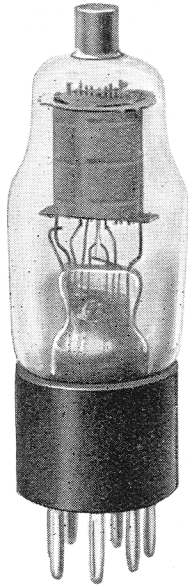

HEPTODE FREQUENCY CHANGER TYPE 15A.2

The BRIMAR 15A.2 is an indirectly heated frequency changer of the heptode or pentagrid type, designed to perform simultaneously the functions of mixer and oscillator in receivers of the super-heterodyne class.

These functions are accomplished in a single valve comprising a triode unit and a screened grid or tetrode unit coupled by a common electron stream.

The triode unit functions as an oscillator, the oscillations modulating the electron stream of the tetrode unit, producing in the anode circuit the required I.F. frequency.

The tetrode portion of the valve is designed with a variable μ characteristic; thus enabling the conversion gain to be varied over a wide range by variation of tetrode control grid bias. Great care has been taken in the design of this valve to eliminate frequency drift. How far the designers have been successful may be gathered from the following information. At 1,500 K.C. the application of 40 volts bias to the grid of the tetrode portion produces a frequency drift of less than 150 cycles.

Operation details and characteristics are given overleaf. The valve is fitted with a seven-pin base, connections being as shown on page 51.

BRIMAR

CHARACTERISTICS

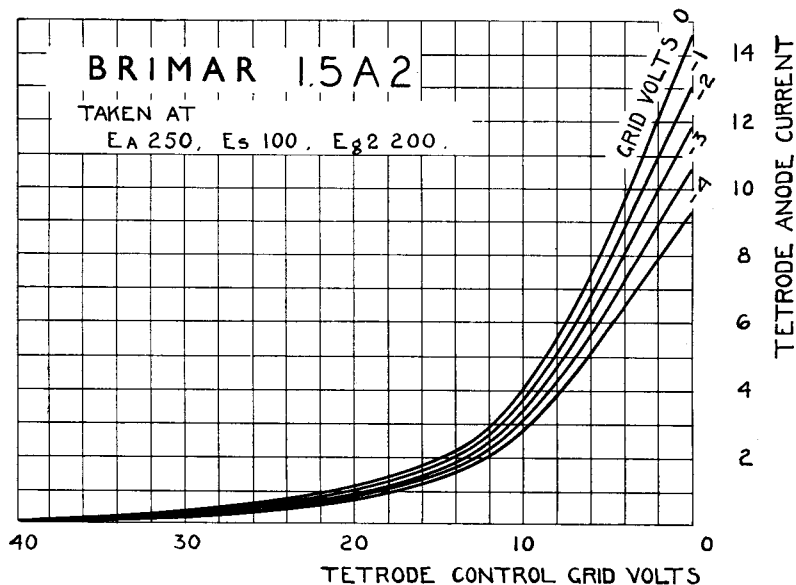

Heater Voltage	4 volts \pm 5%
Heater Current	0.65 amp.
Tetrode Anode Voltage (maximum)	250 volts
Screen Voltage (maximum)	100 volts
Triode Anode Voltage (maximum)	200 volts
Conversion Conductance	550 Micromhos *

* Taken at anode volts (tetrode) 250, screen volts 100.
anode volts (triode) 200, control grids -3 volts.

OPERATING CONDITIONS

Anode Volts	250	150	100
Screen Volts (G.3 & 5)	100	100	50
Triode Anode Volts (G.2)	200	120	100
Grid Volts (G.4)	-3.0	-2.5	-1.5
Grid Leak (G.1) (ohms)	50,000	25,000	10,000
Auto Bias Resistance (ohms)	300	300	150
Screen Supply Resistance (ohms)	—	15,000	20,000
Triode Anode Supply Resistance (ohms)	15,000	10,000	—
Anode Current (mA.)	3.5	3.0	1.5
Screen Current (mA.)	2.0	2.5	2.5
Triode Anode Current (mA.)	4.0	4.0	3.5

VALVES

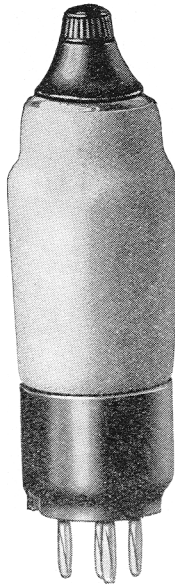

R.F. VARIABLE MU PENTODE TYPE 9A.1

The BRIMAR 9A.1 is an indirectly heated radio frequency pentode valve incorporating a variable mu characteristic. This property eliminates the possibility of cross modulation or modulation distortion occurring when the valve is handling inputs usually associated with the R.F. or I.F. stages of a radio receiver.

The variable mu characteristic also enables the gain of the valve to be varied over a wide range by the application of a varying control grid voltage, thus rendering the valve particularly suitable for use in receivers employing automatic volume control.

The high mutual conductance at minimum operating grid bias, coupled with the low anode grid leakage capacity, enables extremely high stage gains to be obtained with complete stability.

The valve is fitted with a five-pin base, connections being as shown on page 51.

BRIMAR

CHARACTERISTICS

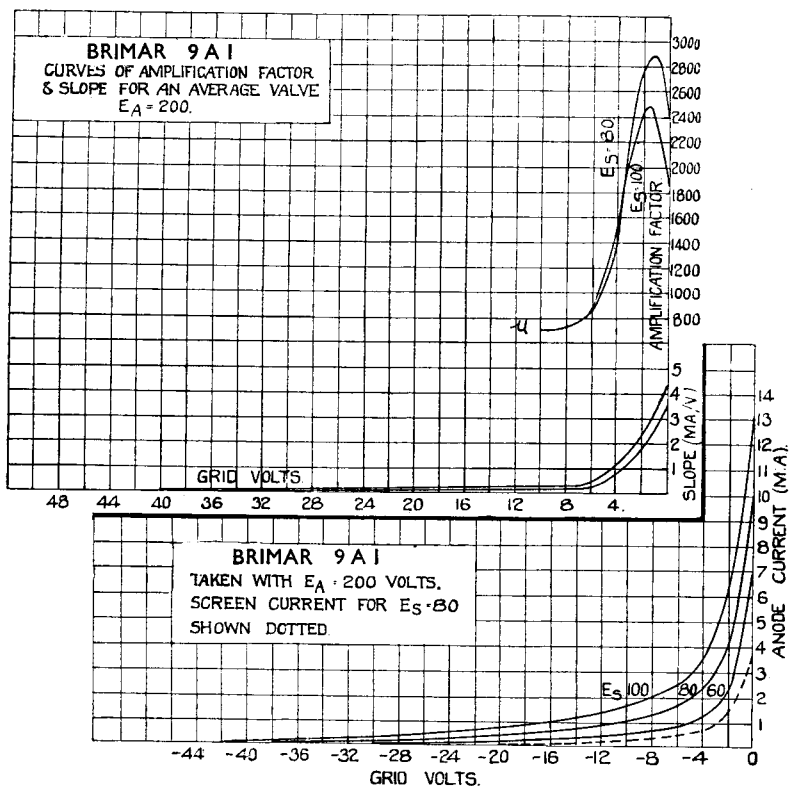

Heater Voltage	4.0 volts \pm 5%
Heater Current	1.0 amp.
Max. Anode Voltage	250 volts.
Max. Screen Voltage	100 volts.
Grid Bias Voltage	-1.5 to -40 volts.
Mutual Conductance	*4.25 mA. per volt. †0.1 mA. per volt.

*Anode volts 200, screen volts 100, grid volts zero.

†Anode volts 200, screen volts 100, grid volts - 35.

VALVES

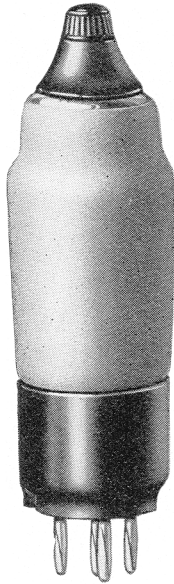

R.F. SCREENED PENTODE TYPE 8A.1

The BRIMAR 8A.1 is an indirectly heated radio frequency screened pentode valve.

It should only be used in R.F. circuits where the input does not greatly exceed 0.5 volts. Where higher voltages are encountered some form of pre-H.F. volume control (or alternatively the 9A.1) should be employed.

As an anode bend detector the 8A.1 is particularly recommended, a large audio output being obtained with a small R.F. grid input. A suitable value of cathode bias resistor being 8,000 ohms, using a screen voltage of 60 and an anode resistor of 0.25 megohms.

As a frequency changer in superheterodynes a high conversion gain can be obtained. While the heater cathode insulation is of a sufficiently high order to prevent noise occurring when using cathode coupling.

The valve is fitted with a five-pin base, connections being as shown on page 51.

BRIMAR

CHARACTERISTICS

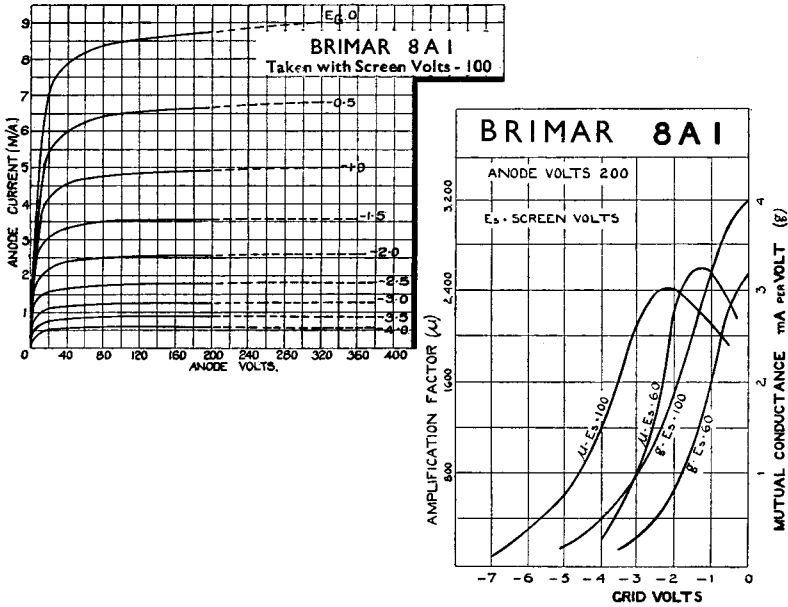

Heater Voltage	4.0 volts \pm 5%
Heater Current	1.0 amp.
Max. Anode Voltage	250 volts
Max. Screen Voltage	100 volts
*Amplification Factor	1,500
*Mutual Conductance	4.0 mA. per volt
*Impedance	375,000 ohms

* Measured at anode volts 200, screen volts 100, grid volts zero.



DOUBLE DIODE TRIODE TYPE 11A.2

The BRIMAR 11A.2 is an indirectly heated double diode triode valve, designed for performing simultaneously the functions of automatic volume control, detection and amplification.

Full-wave or half-wave rectification together with delayed A.V.C. or delayed and amplified A.V.C. may be employed.

To prevent R.F. or I.F. voltages, causing instability by passing into the L.F. stages, the diodes are efficiently screened from the triode portion by an electrostatic screen connected to the cathode.

The valve is fitted with a seven-pin base, connections being as shown on page 51.

For further information and diagrams apply for separate leaflet. See also pages 11 and 12.

BRIMAR

CHARACTERISTICS

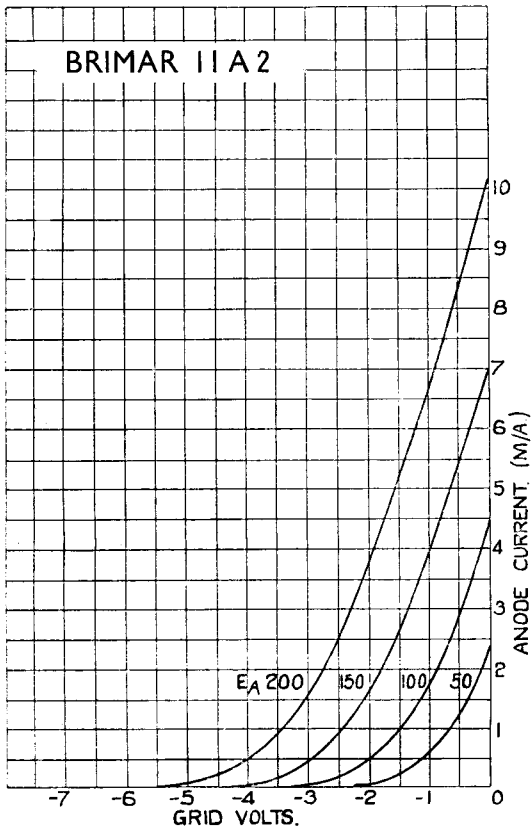

Filament Voltage	4 volts \pm 5%
Filament Current	1.0 amp.
Maximum Anode Volts	200
* Amplification Factor	50
* Impedance	18,000
* Mutual Conductance	2.8

* Taken at anode volts 100, grid volts zero.

VALVES

BRIMAR

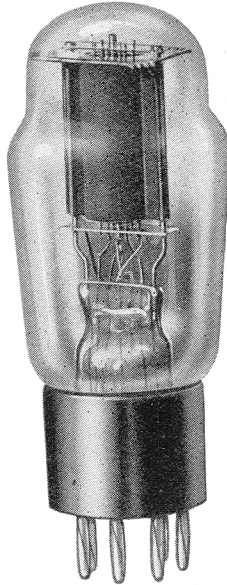

POWER PENTODE TYPE 7A.2

The BRIMAR type 7A.2 is an indirectly heated high efficiency power pentode capable of giving a large power output, with a grid input of approximately 10 volts R.M.S.

This output is more than sufficient to operate large moving coil speakers at considerable volume.

Automatic bias may be obtained by inserting a resistance of approximately 330 ohms in the cathode lead, this should be shunted by a condenser of at least 4 mfd., or a suitable filter network in order to utilise the full gain of the valve, and preserve the lower register.

BRIMAR

CHARACTERISTICS

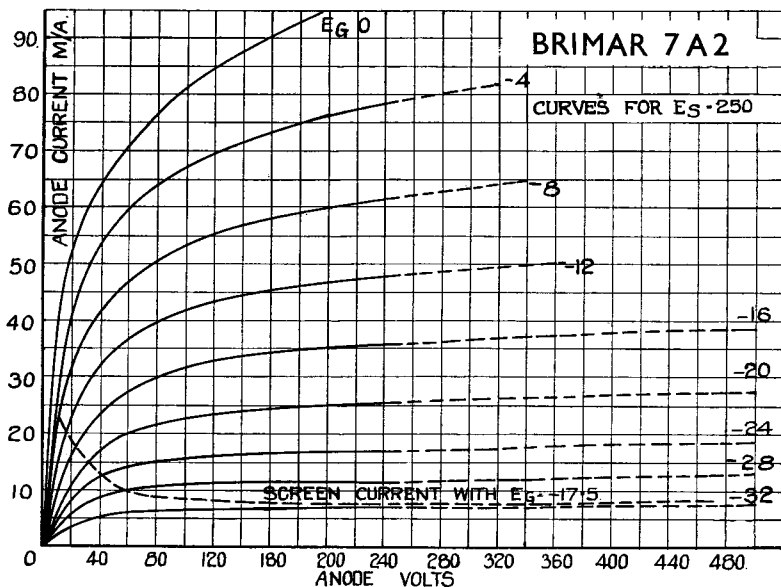

Heater Voltage	4.0 volts \pm 5%
Heater Current	1.2 amps.
Max. Anode Voltage	250 volts
Max. Screen Voltage	250 volts
Max. Anode Current	40 mA.
Normal Grid Bias	17.0 volts
Mutual Conductance	3.2 mA. per volt
Optimum Load	8,000 ohms (approx.)

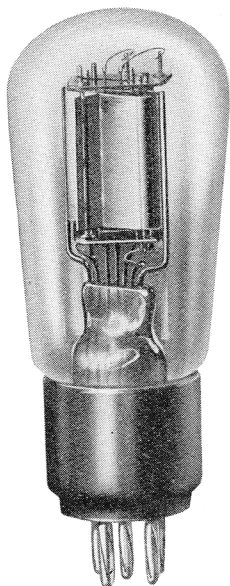

POWER PENTODE TYPE PEN.A.1

The BRIMAR Pen.A.1 is a directly heated power pentode. The valve is fully loaded, with a grid swing of 11 volts R.M.S.

The output being sufficient to operate the average moving coil speaker at considerable volume.

Automatic bias may be obtained by inserting a resistance of approximately 450 ohms between the electrical centre point of filament and H.T. negative.

This should be shunted by a condenser of at least 4 mfd. or a suitable network, in order to utilise the full gain of the valve and preserve the lower register.

BRIMAR

CHARACTERISTICS

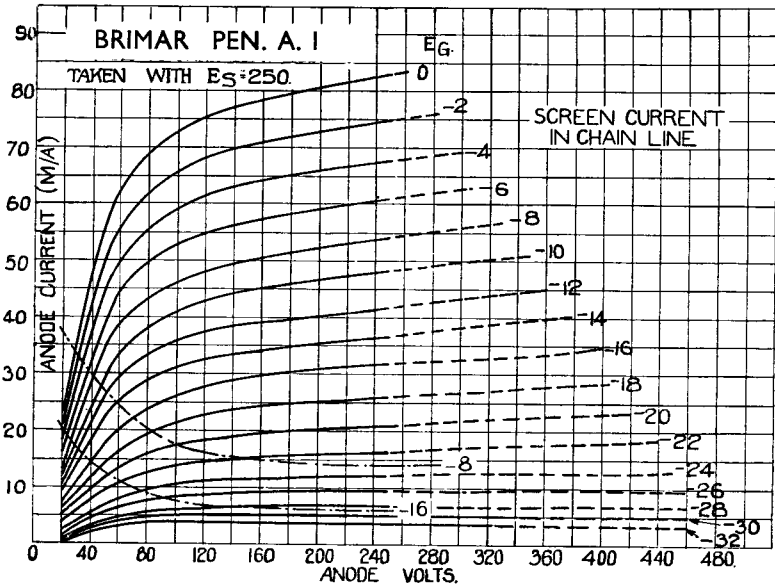

Filament Voltage	4 volts \pm 5%
Filament Current	1.0 amp.
Max. Anode Voltage	250 volts
Max. Screen Voltage	250 volts
Max. Anode Current	32mA.
Mutual Conductance	3.0 mA. per volt
Optimum Load	8,000 ohms (approx.)

VALVES

BRIMAR

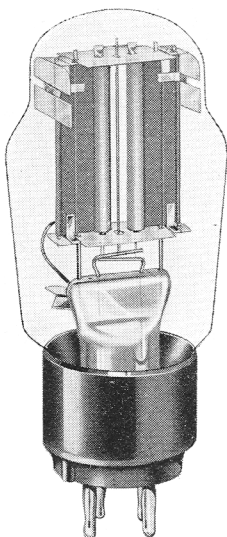

RECTIFIER VALVES TYPES R.1, R.2, R.3, 1A.7

These BRIMAR rectifiers are all of the indirectly heated type, designed to give a long and useful life. Owing to the fact that these valves heat up at the same speed as the receiving valves, no undue voltage strain is thrown on the smoothing circuits, as is experienced with other types of rectification.

Full advantage is taken of the unique BRIMAR construction, which allows of adequate cooling of the anodes, resulting in an extremely long life. In addition, the close spacing of the electrodes reduces the impedance to a small value, resulting in a somewhat higher D.C. output than is possible with other types of rectifiers.

The 1A.7 is an exact electrical equivalent of the R.2, but is fitted in a smaller bulb, making the valve extremely useful where space is a major consideration.

Curves and operation details are given overleaf.

The valves are fitted with four-pin bases, connections being as shown on page 51.

VALVES

BRIMAR

CHARACTERISTICS

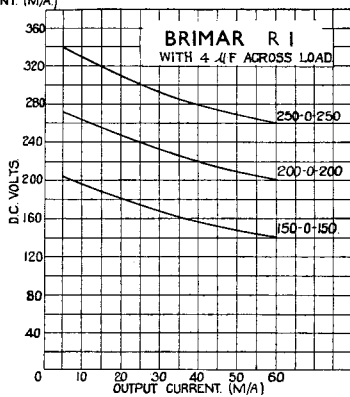
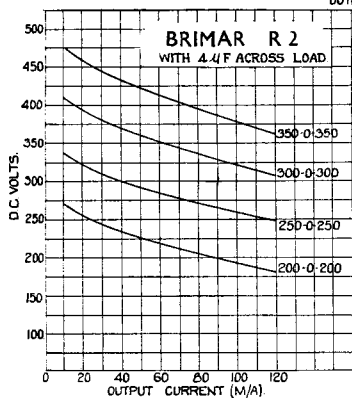
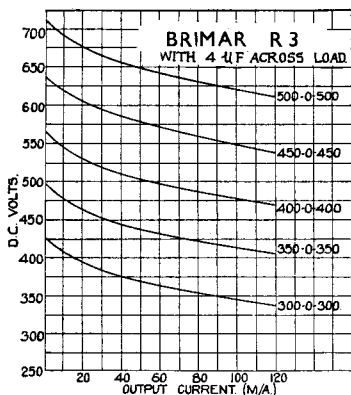

	R.1	R.2	R.3	1A.7
Heater Volts	4.0	4.0	4.0	4.0
Heater Amps.	1.0	2.25	2.5	2.25
Max. Anode Voltage R.M.S. ...	250-0-250	350-0-350	500-0-500	350-0-350
Max. Rectified Current mA.	60	120	120	120

VALVES

BRIMAR

THE TUNOGRAPH

The BRIMAR "Tunograph" is essentially a visual resonance indicator, and as such can be used in a radio receiver to facilitate and indicate correct tuning.

In receivers employing automatic volume control, many people experience considerable difficulty in tuning accurately to the wanted station. When the BRIMAR "Tunograph" is employed, however, this is simplicity itself.

The "Tunograph" is a modification of the well-known Standard Telephone's Cathode Ray Oscillograph tube, operating on precisely the same principle, but produced at an extremely competitive price for incorporation in radio receivers.

As the power required to operate the "Tunograph" is negligible, it can be used in circuits where other forms of indicator cannot be employed.

Filament Current	0·85-1·0 amp.
Filament Voltage	0·5-0·6 volts
Minimum Plate Voltage	180
Sensitivity (approx.)	13 volts per cm. with plate volts 250

Further details and circuits are given on page 46.

BRIMAR

TUNOGRAPH

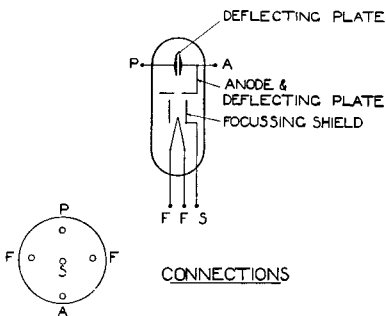

FOR VALVE CONTROLLED BY A.V.C.

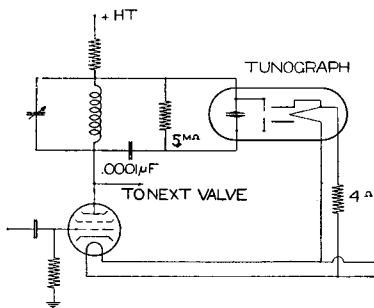
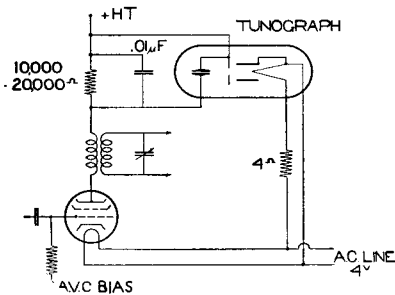

THIS CIRCUIT GIVES A LINE DEFLECTION

VALVES

HOT CATHODE MERCURY VAPOUR RECTIFIER

TYPE 4037-A

The 4037-A VALVE is a hot cathode mercury vapour rectifier designed for medium power outputs. When the valve is first installed, or after it has been agitated in any way, the filaments should be switched on for at least ten minutes before applying the H.T. in order that the mercury may become correctly distributed.

OPERATING INSTRUCTIONS

The filament must be switched on for at least 20 secs. before the H.T. is applied. Failure to observe this precaution will result in damage to the valve. The use of some kind of delay switch having a delay action of about 30 secs. is recommended.

The voltage drop across the valve in the forward direction should not exceed 15 volts. If this figure is exceeded it is an indication that the filament is operating at too low a temperature; and should this state of affairs be allowed to continue a greatly decreased life will result.

Since the voltage drop is not more than 15 volts in the positive direction it is essential that no positive voltage in excess of this figure should be applied unless a series resistance is connected in the circuit to limit the current.

The accompanying curves show the relation between volts and current output for two input voltages obtained with the typical rectifier circuit indicated.

BRIMAR

CHARACTERISTICS

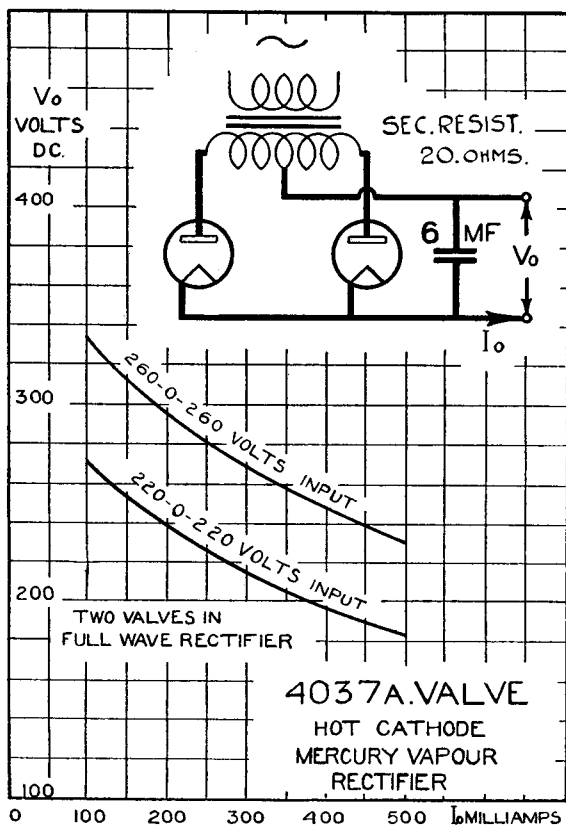

Filament volts	4.0 volts
Filament current	2.0 amps.
Peak anode current	0.75 amps.
Peak inverse voltage	1,000 volts
Output as half wave rectifier on resistance load—75 watts (300 volts at 250 m/A).					
Base—Standard BVA 4 Pin.					
Connections are shown on page 51.					

VALVES

HOT CATHODE MERCURY VAPOUR RELAY TYPE 4039A

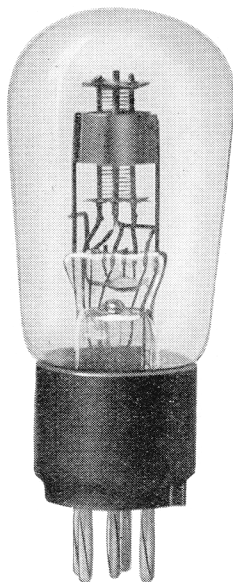

CHARACTERISTICS

Heater Volts	...	4.0
Heater Current (amps.)	...	1.0
Peak Anode Current (mA)	...	200
Continuous Anode Current (mA)	...	100
Peak Anode Volts	...	500
Control Ratio (approx.)	...	35/1
Cathode Heating Time	...	30 seconds minimum

DIMENSIONS (APPROX.)

Overall length ... 115 mm. Overall diameter ... 47 mm.

The 4039A. is a grid controlled mercury vapour relay with an indirectly heated cathode. In using this valve it is important to remember that once the anode discharge has been started, it cannot be cut off except by reducing the anode voltage below the ionisation value of mercury vapour (about 15-25 V. according to the temperature of the vapour). The 4039A. is particularly suited for use in linear time base circuits for cathode ray oscillograph and television equipment, etc.

The actual grid control ratio of the valve is dependent upon the temperature of the surrounding air. Reduction in temperature will be found to increase the control ratio. This change in the control ratio is due to the change in the pressure of the mercury vapour inside the valve.

The valve should not be placed in a position where its temperature is likely to rise appreciably during operation. This is particularly important where voltages approaching the maximum allowed are being used.

The 4039A. is fitted with a five-pin base, connections being as shown on page 51.

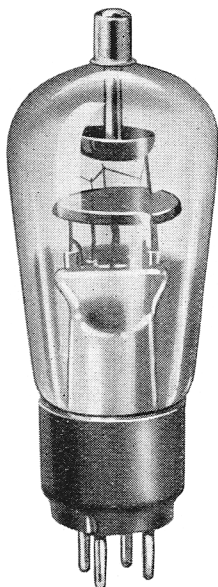

RECTIFIER VALVE TYPE V.L.S.61

This valve has been especially developed for supplying High Tension Power for Cathode Ray Oscillograph Equipments, Television Apparatus, etc.

SPECIFICATION.

Cathode	Oxide coated filament.
Base	B.V.A. 4 pin, "grid" and "plate" pins not connected, plate connected to top cap.
Dimensions	Overall height 5 $\frac{1}{4}$ " (13.4 cms) Bulb diameter 2" (5.1 cms)
Constants	Filament Voltage 2 volts Nominal Fil. Current 1.2 amps. Peak Instantaneous Current 10 m.a. Peak Inverse Voltage 15,000 volts.
Output	As half wave rectifier 6,000 volts 3 m.a.

BRIMAR

BASE CONNECTIONS OF VALVES

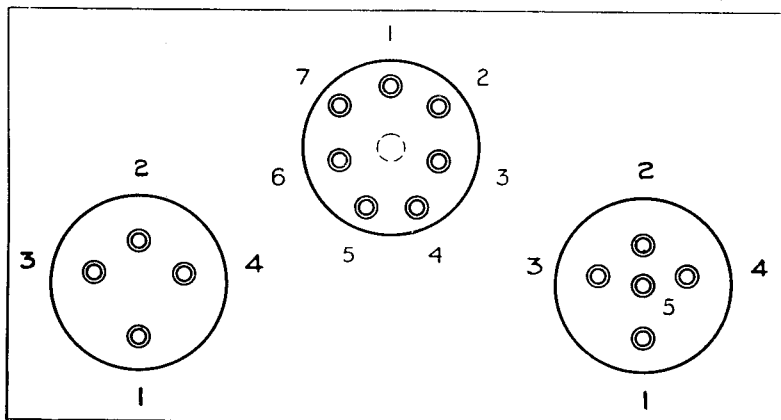

UNDERSIDE VIEW OF BASES
4-PIN VALVES

TYPE	1	2	3	4
HLB.1, PB.1	A	G	F.M	F
R.1, R.2, R.3, 1A.7	A1	A2	H	H.C
4037A.	A	—	F	F

5-PIN VALVES

TYPE	1	2	3	4	5	Top Cap
8A.1, 9A.1 ...	G2	G1	H	H	C.M	—
HLA.2, PA.1 ...	A	G	H	H	C.M	—
PenB.1, PenA.1 ...	A	G1	F	F	G2	—
4039A ...	A	G	H	H	C	—
ID5 ...	A	—	H	H	C	—

7-PIN VALVES

TYPE	1	2	3	4	5	6	7	Top Cap
4D.1 ...	—	—	—	H	H	C	A	G
7A.3, 7D.8, 7D.6, 7A.2, & 7D.3 ...	—	G1	G2	H	H	C	A	—
9D.2 ...	—	A	G3	H	H	C	G2	G1
11A.2, 11D.3	D1	M	D2	H	H	C	A	G1
15A.2, 15D.1	G2	G1	G3.G5	H	H	C	A	G4

A. Anode. G1, G2, G3, G4, 1st, 2nd, 3rd and 4th Grids.
F. Filament. H. Heater. C. Cathode. D1, D2, Diodes.
M. Metallising.

VALVES

SUMMARY OF

Type	Purpose	Cathode			Anode Voltage Normal	Screen Voltage Normal
		Type	Voltage Volts	Current Amps		
15D1	Frequency Changer	Indirectly Heated	13·0	0·2	250	100
9D2	Vari-Mu R.F. Pentode	„	13·0	0·2	250	125
11D3	Double Diode Triode	„	13·0	0·2	250	—
4D1	Detector L.F. Amplifier Oscillator	„	13·0	0·2	200	—
10D1	Double Diode	„	13·0	0·2	—	—
7D6	High Slope Power Pentode	„	40·0	0·2	250	250
7D8	„	„	13·0	0·6	250	250
7D3	Power Pentode	„	40·0	0·2	135	135
4215A	Detector L.F. Amplifier Oscillator	Directly Heated	1·0	0·25	45	—
PenB1	Power Pentode	„	2·0	0·2	150	150
HLA2	Detector L.F. Amplifier Oscillator	Indirectly Heated	4·0	1·0	200	—
PA1	Power Output Triode	„	4·0	1·0	200	—
15A2	Frequency Changer	„	4·0	0·65	250	100
9A1	Vari-Mu R.F. Pentode	„	4·0	1·0	200	80
8A1	R.F. Pentode	„	4·0	1·0	200	80
11A2	Double Diode Triode	„	4·0	1·0	100 200	—
7A2	Power Pentode	„	4·0	1·2	250	250
7A3	High Slope Power Pentode	„	4·0	2·0	250	250
PenA1	Power Pentode	Directly Heated	4·0	1·0	250	250

CHARACTERISTICS

Grid Bias Normal	Anode Current Normal mA	Anode Impedance Ohms	Amplification Factor	Mutual Conductance	Optimum Load Ohms	Auto Bias Resistor Ohms	Page
-3 -40	3.5 —	300,000 —	—	550* 2*	—	300	3
-3 -40	10.0 —	600,000 —	1,000 —	1.65 .01	—	200	7
-2	0.4	90,000	100	1.2	—	5,000	9
-3	5.0	10,000	40	4.0	—	800	13
—	—	—	—	—	—	—	15
-6	32.0	—	—	10.0	8,500	150	16
-6	32.0	—	—	10.0	8,500	150	16
-20	40.0	37,000	85	3.8	4,000	500	19
-3	0.8	25,000	6	0.4	—	—	23
-4.5	8.0	—	—	2.5	18,000	—	25
-2	8.0	9,000	50	5.5	—	400	27
-9	50.0	1,050	12.6	12	4,000	260	29
-3 -40	3.5 —	300,000 —	—	550* 2*	—	300	31
-1.5 -35	5.0 0.1	600,000	2,500	4.25	—	200	33
-1.5	3.5	600,000	2,400	4.0	—	200	35
-1.0 -2.0	1.5 3.0	18,000	50	2.8	—	—	37
-17.5	32.0	—	—	3.2	8,000	330	39
-6	32.0	—	—	10.0	8,500	150	16
-16.5	32.0	—	—	3.0	8,000	450	41

* Conversion conductance in Micromhos.

Printed in England by
THE VICTORY PRESS
LEICESTER
—
63916

BRIMAR
VALVES TRADE MARK